

**Makita**<sup>®</sup>

# 2023 GENERAL CATALOGUE



**XGT** **80V**<sub>max</sub>  
40V<sub>max</sub>+40V<sub>max</sub>

# KEY TO SYMBOLS

	Double Insulation		SDS-PLUS		Depth Adjustment
	Variable Speed		SDS-MAX		Sequential and Bump-fire
	Brake		17mm Hex		Wire Collated Nail
	Reversing		19mm Hex		Sheet Collated Nail
	Mechanical 2-Speed		21mm Hex		Inlet Filter
	Mechanical 3-Speed		28.6mm Hex		Auto Firing Stop
	Electronic 2-Speed		30mm Hex		Stainless Tank
	Electronic 3-Speed		Spline Shank		Static Free Hose
	Electronic 4-Speed		Dust Collection		Anti Vibration
	Keyless Chuck		Hook & Loop		Automatic Oiling
	Torque Setting 6		Revolving Hose		Chain Brake
	Torque Setting 9		Bevel Cutting 45 left		Primer Pump
	Torque Setting 16		Bevel Cutting 45 LR		Capacitor Discharge Ignition
	Torque Setting 18		Bevel Cutting L45 R5		Auto Decompression
	Torque Setting 20		Orbital Cutting		Rapid Start
	Torque Setting 21		Makita Shank Jig Saw Blade		Carrying Case
	Clutch-equipped		Bayonet Shank Jig Saw Blade		
	Torque Limiter		Laser Marker		
	Constant Speed		Brake		
	Soft Start				
	Built-in Job Light				



# HIGH PERFORMANCE WITH BRUSHLESS DC MOTOR

## BL MOTOR

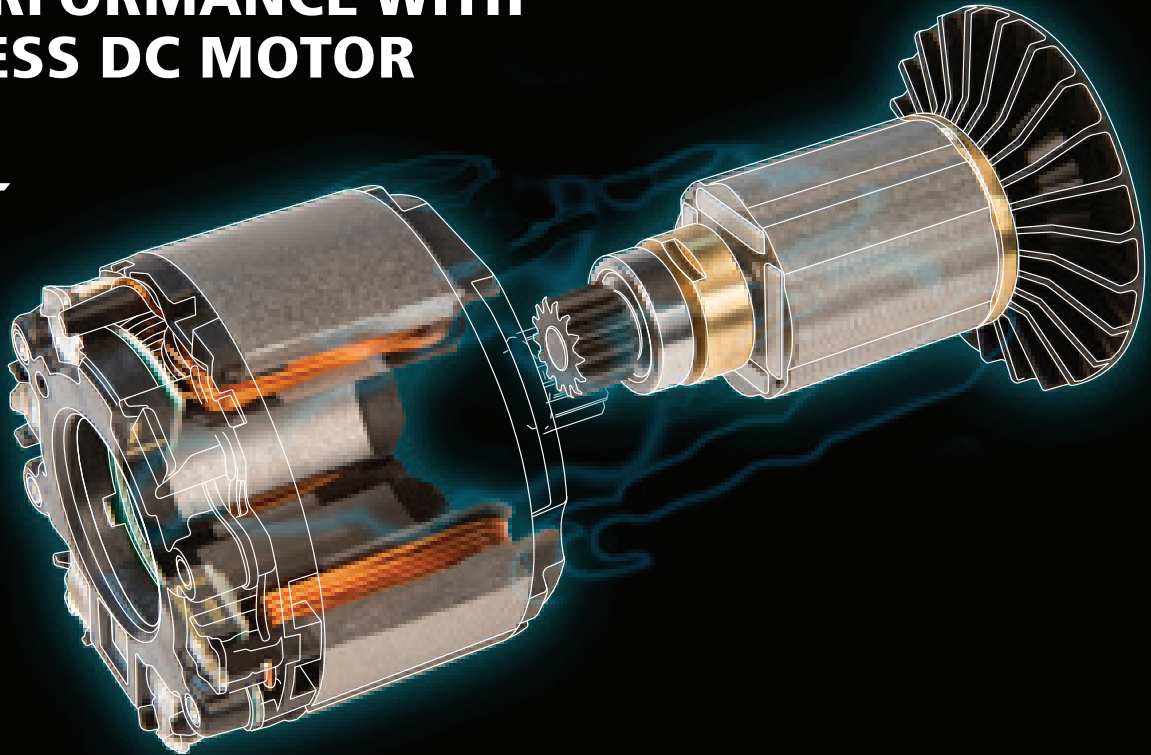

### UP TO 50% LONGER MOTOR LIFE

Makita-built Brushless Motor eliminates carbon brushes, enabling the motor to run cooler and more efficiently for longer life.

(Compared to Cordless Motors with Brushes)

## VARIOUS TYPES OF BRUSHLESS MOTORS



**OUTER ROTOR - 108mm**

A direct-drive system that delivers the highest operating efficiency for more power, more speed and longer run time. The outer rotor brushless motor is inside select chain saws and string trimmers.

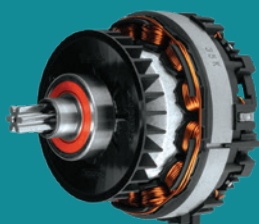

**122mm, 80mm, 68mm, 52mm, 44mm, 38mm**

Built for higher power and efficiency in a compact size with all-metal gear construction for extended durability



**Dust extractor starts automatically when the tool starts.  
Also dust extractor stops on its own when the tool is in rest**

## Auto-start wireless system

The AWS dust extractor runs only while the AWS power tool is in use which benefits:-

- i) Extends battery run time of the dust extractor increasing productivity on a single charge.
- ii) Reducing continuous noise at the work site due to dust extractor will switch off automatically if the tool is not in use.
- iii) Reduced time wasted on manually powering the dust extractor on and off.



Using our cordless dust extractor with a cordless Li-ion tool means freedom of movement, reduced safety hazards and no plug-in or power issue

WATCH VIDEO



## HOW IT WORKS



1 Set the stand-by switch on the dust extractor to "AUTO" (FOR VC004GL, DVC864L / DVC154L) / "Slide On" (FOR VC009G, DVC265 / DVC665)



2 Press the wireless activation button on the dust extractor for 3 seconds until the wireless activation lamp blinks in GREEN



3 Then press the wireless activation button on the tool until the wireless activation lamp blinks in GREEN

Also you can disengage the paired dust extractor and tools by pressing the wireless activation button on the dust extractor for 6 seconds which turns wireless activation lamp to blink in green and then become in red. After that, press the wireless activation button on the tool in the same way

Also note that the paired wireless unit can be used with any AWS equipped machines and need not to pair again until if it is disengaged.

## Multiple Connections

Can connect upto 10 AWS tools at a time with single dust extractor, just reconnect the dust hose when switching between power tools, this will reduce time wasted on manually powering multiple tools on and off

### Wireless unit (Bluetooth chip) Part#: 198900-7



Wireless unit (bluetooth chip) utilizes Bluetooth technology for wireless power-on/off communication. Please make sure the wireless unit (bluetooth chip) is inserted in the wireless unit slot on the Tool/Dust extractor before pairing.

### AWS-Start Wireless Adapter - WUT02 Part #: 199838-9



WUT02 adapts to AC Dust Extractors VC3210LX1 / VC3211HX1 and enables wireless On/Off communication with Makita AWS tools (BLUETOOTH CHIP SOLD SEPARATELY)



# AFT

## Active Feedback Sensing Technology (AFT)

- Smart function to minimize the danger of kick-back
- Shuts down the tool if the rotation speed suddenly slows down

Note: The function of AFT is not to prevent the occurrence of kickback

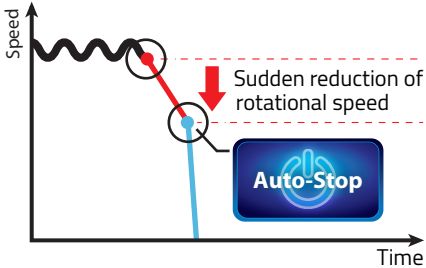

# ADT

## Automatic Torque Drive Technology (ADT)

Automatically changes the speed according to load conditions for an optimum operations:

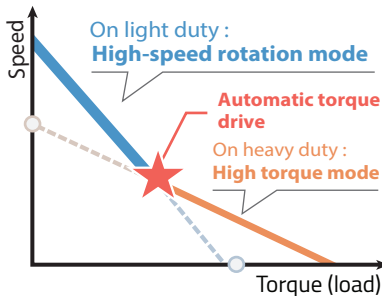

# DXT

## Deep and Exact Cutting Technology (DXT)



Deep and Exact Cutting Technology (DXT) is a series of features that give Makita miter saws more cutting capacity and out-of-the-box accuracy for superior cutting performance.



## SUPER JOINT SYSTEM (SJS II)

SJS II provides a leaf spring and cam gear drive mechanism that is engineered to reduce vibration for increased operator comfort during extended use



# AVT

## Anti Vibration Technology (AVT)

The benchmark in vibration reduction Makita demolition tools are among the best in the world. Working with the users to solve the problem of vibration Makita's AVT products have been designed in close relation to users needs at site level.

Active dynamic vibration absorber moves in the opposite direction to the drive piston to reduce vibration.

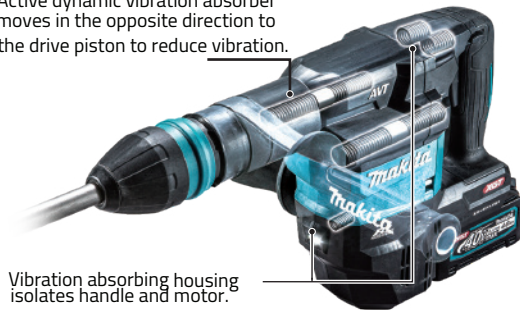

Vibration absorbing housing isolates handle and motor.

# XPT

## Extreme Protection Technology (XPT)

For use in outdoor applications or harsh environments, protection from dust and dripping water

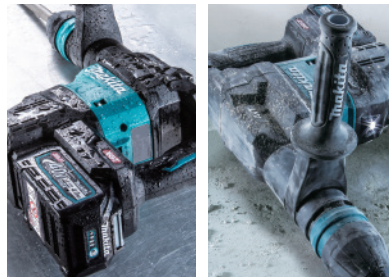

## Wet Guard

High water-resistance allows to operate the machine even if it is wet with water.

Has the same dustproof structure as XPT.

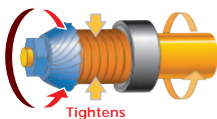

With the rotation of armature shaft, Coil-Spring is extended and its tightening force increases so that armature shaft is fixed firmly and transmitted to spiral bevel gear.



## SUPER JOINT SYSTEM

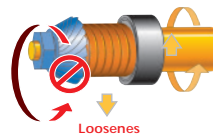

If the grinding wheel catches or binds, the coil spring relaxes and disengages the gears from the motor. As the grinding wheel stops, the gears and motor are protected.

### IMPACT BLACK ACCESSORIES

Impact Black is the High Durability accessories range (Screwbits / Impact Sockets) for professional use  
 - Anti-rust treatment on the bit surface with high-class matte black appearance  
 - Makita logo on the accessories makes it easy to distinguish



### NEMESIS II

### DRILLING INTO REINFORCED CONCRETE IS NO LONGER A HIT AND MISS APPLICATION

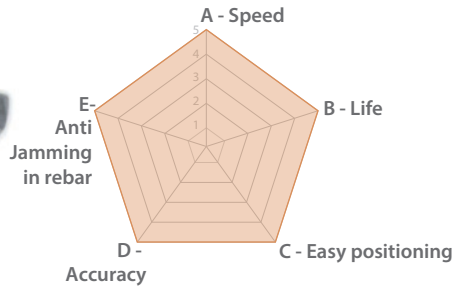

- Its unique symmetrical head geometry ensures precision drill holes.
- Perfect for use in the hardest of natural stone.
- Perfect for critical anchor fixings and where spot drilling is required.
- The Nemesis will drill up to 50% more holes than normal rotary hammer drill bits



### PREMIUM RANGE DIAMOND WHEELS - COSMOS



Our premium diamond wheels "The Cosmos System" (Nebula and Comet) brings a universal approach to blade selection. Advanced segment bonds allow for premium performance across a wider range of materials. The Cosmos premium range of diamond wheels have been carefully crafted to best meet the demanding needs of professional users. Cosmos system feature our unique diamond wheel technology, which helps to provide outstanding cutting performance. As such, the wheels are able to cut faster and last longer than traditional ones.

#### LASER WELDED

Improve productivity and speed of cut

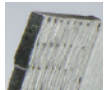

#### V-SHAPED SEGMENTS

Reduce friction and improve cooling.



#### FIXED METAL BOSS

For quiet operation

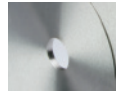

#### 3DDG TECHNOLOGY

For faster cutting and longer tool life

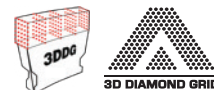

#### COOLING HOLES

Prevent expansion of the wheel and ensure a smooth cutting



### PREMIUM TCT SAW BLADES "EFFICUT"



Efficut Saw blades are ultra-thin, perfectly tensioned steel plates for true run. The high-grade carbide tip of the saw blades are designed to provide higher efficiency, durability and longer life. These blades provide higher performance than the standard blades. The cutting efficiency and the amount of cutting per charge are increased when used with cordless machines.

## INDEX

<b>BATTERY AND CHARGERS</b>	<b>022</b>	<b>SAWING</b>	<b>239</b>	<b>OPE AND GARDEN TOOLS</b>	<b>368</b>
Battery and Chargers Compatible Chart	024	Slide Compound Miter Saw	241	Multi Function Power Head	371
Power Source Kit	028	Miter Saw	244	Chain Saw / Pruning Saw	372
Portable Power Pack Unit	029	Table Top Miter Saw	245	Telescopic Pole Saw	376
<b>DRILLING / FIXING</b>	<b>030</b>	Flip Over Saw	245	Pruning Shear	376
Driver Drill	031	Table Saw	245	Hedge Trimmer	377
Percussion Driver Drill	035	Band Saw	246	Pole Hedge Trimmer	382
Angle Drill	039	Circular Saw	248	Grass Shear	383
Drill	041	Rear handle Circular Saw	252	Grass Trimmer / String Trimmer / Brush Cutter	384
Drill Press	043	Plunge Cut Circular Saw	253	Edger	389
Impact Drill	044	Jig Saw	254	Lawn Mower	390
Diamond Core Drill	047	Reciprocating Saw	258	Blower	398
Magnetic Drill	047	Scroll Saw	260	Mist Blower	405
Impact Driver	048	Cut-Out Tool	261	Sprayer	405
Screwdriver	052	Drywall Cutter	261	Earth Auger	407
Drywall Screwdriver	054	Accessories	262	Wheel Barrow	408
Auto Feed Screwdriver	054	<b>MULTI TOOL / MULTI CUTTER</b>	<b>282</b>	Generators	410
Rivet Gun	055	Multi Tool	282	Accessories	412
Impact Wrench	056	Multi Cutter	283	<b>JOBSITE TOOLS</b>	<b>428</b>
Accessories (Drilling)	061	Accessories	284	Cooler / Warmer Box	429
Accessories (Fixing)	085	<b>ROUTING / PLANING</b>	<b>291</b>	Microwave	430
<b>CONCRETE DRILLING / DEMOLITION</b>	<b>099</b>	Power Planer	292	Coffe Maker	431
Rotary and Combination Hammers	101	Planer / Thicknesser	294	Kettle	431
Demolition Hammers	117	Plate Joiner	294	Jackets and Vest	432
Power Scraper	121	Trimmer	295	Inflator	434
Accessories (Drilling)	122	Router	296	Flashlight / Worklight	436
Accessories (Demolition)	129	Sash Router	297	Radio and Speaker	444
<b>STIRRING AND MIXING</b>	<b>138</b>	Accessories	298	Fan	446
Mixer	139	<b>STAPLER / PINNER / BRAD NAILER / COIL NAILER</b>	<b>322</b>	Adapter	448
Concrete Vibrator	140	Brad nailer	323	Accessories	450
Accessories	141	Pneumatic Brad Nailer	324	<b>SPECIALITY TOOLS</b>	<b>451</b>
<b>CUTTING (CONCRETE / METAL)</b>	<b>142</b>	Stapler	325	Rebar Tying Tool	452
Power Cutter	143	Pinner	215	Wall Scanner	453
Angle Cutter	144	Coil Nailer	326	Grease Gun	453
Tile Cutter	145	Accessories	327	Caulking Gun	454
Wall Chaser	146	<b>HEAT GUN</b>	<b>329</b>	Vacuum Pump	454
Metal Cutter	147	Heat Gun	330	Air Compressor	454
Compact Cut Off	147	Accessories	331	<b>COMBO KITS</b>	<b>455</b>
Portable Band Saw	148	<b>LASER</b>	<b>332</b>	LXT Combo	455
Aluminum Groove Cutter	149	Multiline Laser	333	CXT Combo	455
Metal Cutting Saw	149	Cross line Laser Level	335	<b>HAND TOOLS AND COMBINATION SETS</b>	<b>456</b>
Portable Cut-off Saw	149	Laser Distance Measure	336	Hand Tools	457
Steel Rod Cutter	151	Rotating Laser Level	337	Combination Sets	463
Threaded Rod Cutter	152	Self Leveling Laser Level	337	Tools Pouches and Holders	472
Hole Puncher	153	Accessories	338	Makpack Case / Cooler Box	476
Shears	154	<b>CLEANING</b>	<b>339</b>	Carbon Brush	477
Nibblers	155	Drum Type Vacuum Cleaner	341		
Accessories	156	Backpack Vacuum Cleaner	345		
<b>GRINDING</b>	<b>164</b>	Upright Vacuum Cleaner	347		
Angle Grinder	165	Cyclone Cleaner	347		
Die Grinder	187	Robotic Cleaner	348		
Straight Grinder	189	Portable Cleaner / Car Cleaner	349		
Bench Grinder	190	Stick Type Cleaner	350		
Concrete Planner	191	Accessories (Attachments & Dust Bag / Filters)	352		
Accessories - Diamond Wheels	192	Dust Collecting Chart with Power Tools	358		
Accessories - Abrasive Wheels / Flap Disc	199	High Pressure Washer	365		
Other Accessories	210	Accessories - High Pressure Washer	367		
<b>SANDING AND POLISHING</b>	<b>217</b>				
Polisher	218				
Angle Sander	220				
Disc Sander	221				
Belt Sander	222				
Wheel Sander	224				
Random Orbital Sander	225				
Finishing Sander	226				
Drywall Sander	229				
Accessories	230				

<b>1</b>		
1911B	Power Planer	293
<b>2</b>		
2012NB	Planer / Thicknesser	294
2107FK	Portable Band Saw	148
2414	Portable Cut Off	150
2414B	Portable Cut Off	150
2416S	Portable Cut Off	150
2703	Table Saw	246
2704N	Table Saw	246
2712	Table Saw	245
<b>3</b>		
3601B	Router	296
3612BR	Router (Plunge Type)	297
3709	Trimmer	296
<b>4</b>		
4100NH	Cutter	145
4107R	Cutter	145
4112HS	Angle Cutter	144
4131	Metal Cutter	147
4300BV	Jigsaw	256
4326	Jigsaw	256
4327	Jigsaw	256
4329	Jigsaw	257
4350CT	Jigsaw	257
4350FCT	Jigsaw	257
4351FCT	Jigsaw	257
4403	Sash Router	297
<b>5</b>		
5007N	Circular Saw	251
5143R	Circular Saw	250
5402	Circular Saw	250
5800NB	Circular Saw	252
<b>6</b>		
6010B	Drill	041
6305	Drill	042
6408	Drill	041
6413	Drill	042
6501	Drill	041
6821	Drywall Screwdriver	054
6842	Auto Feed Screwdriver	055
6904VH	Impact Wrench	060
6906	Impact Wrench	059
6953	Impact Wrench	060
<b>8</b>		
8419B2	Impact Drill	044
8420V	Impact Drill	045
<b>9</b>		
9015B	Angle Grinder	178
9031	Belt Sander	222
9032	Belt Sander	222
9046	Orbital Sander	228
9105	Straight Grinder	190
9207SPB	Sander-Polisher	220
9218PB	Polisher	219
9218SB	Disc Sander	221
9237CB	Sander-Polisher	219
9401	Belt-Sander	223
9403	Belt-Sander	224
9404	Belt-Sander	224
9520B	Angle Grinder	176
9521NB	Angle Grinder	176
9522NB	Angle Grinder	176
9553HN	Angle Grinder	177
9554HN	Angle Grinder	177
9555HN	Angle Grinder	177

9556HN	Angle Grinder	178
9556HP	Angle Grinder	178
9557HN	Angle Grinder	178
9557HP	Angle Grinder	178
9558HN	Angle Grinder	178
9558HP	Angle Grinder	178
9561CR	Angle Grinder	180
9562CR	Angle Grinder	180
9563HZ	Angle Grinder	179
9564PC	Angle Grinder	181
9565HZ	Angle Grinder	179
9565PZ	Angle Grinder	180
9741	Wheel Sander	224
9910	Belt Sander	223
9920	Belt Sander	223
9924DB	Belt Sander	223
<b>A</b>		
AC001G	(DC) Compressor	454
ADP001G	Adapter	448
ADP05	Adapter	448
ADP06	Adapter	449
ADP08	Adapter	449
ADP09	Adapter (AA Battery Pack)	449
AF301	Pneumatic Brad Nailer	323
AF506	Pneumatic Brad Nailer	323
AN613	Pneumatic Coiler Nailer	326
AS001G	(DC) Blower / Inflator	403
AT1025B	Pneumatic Stapler	325
AT1225BZ	Pneumatic Stapler	326
AT425B	Pneumatic Stapler	326
<b>B</b>		
BHX2500	Petrol Blower	402
BO3700	Finishing Sander	227
BO3710	Finishing Sander	227
BO4556	Finishing Sander	228
BO4566	Finishing Sander	228
BO4900	Finishing Sander	227
BO4901	Finishing Sander	228
BO5030	Random Orbit Sander	225
BO5041	Random Orbit Sander	225
BO6030	Random Orbit Sander	226
BO6050J	Random Orbit Sander	226
<b>C</b>		
CA5000XJ	Aluminium Groove Cutter	149
CC301D	(DC) Cutter	145
CE001G	(DC) Power Cutter	143
CE002G	(DC) Power Cutter	143
CF001G	(AC + DC) Fan	447
CF002G	(AC + DC) Fan	446
CF003G	(AC + DC) Fan	446
CF100D	(AC + DC) Fan	447
CF101D	(AC + DC) Fan	447
CG100D	(DC) Caulking Gun	454
CL001G	(DC) Cleaner (Stick)	351
CL002G	(DC) Cleaner (Stick)	351
CL003G	(DC) Cleaner (Stick)	351
CL106FD	(DC) Cleaner (Stick)	351
CL108FD	(DC) Cleaner (Stick)	351
CL117FD	(DC) Cleaner	351
CL121D	(DC) Cleaner / Blower	349
CLX203AX4	(DC) CXT Combo Kit	455
CP100D	(DC) Multi Cutter	283
CS002G	(DC) Metal Cutter	147
CW001G	(AC) (DC) Warmer Cooler Box	430
CW002G	(AC) (DC) Warmer Cooler Box	429
CW003G	(AC) (DC) Warmer Cooler Box	430

CW004G	(AC) (DC) Warmer Cooler Box	429
<b>D</b>		
DA001G	(DC) Angle Drill	039
DA3010	Angle Drill	040
DA332D	(DC) Angle Drill	040
DA4000LR	Angle Drill	040
DAS180	(DC) Dust Blower	403
DBM131	Diamond Core Drill	047
DBM230	Diamond Core Drill	047
DB0180	(DC) Random Orbit Sander	225
DB0380	(DC) Finishing Sander	226
DB0381	(DC) Finishing Sander	227
DB0482	(DC) Finishing Sander	226
DBS180	(DC) Belt Sander	222
DCC501	(DC) Tile Cutter	145
DCE090	(DC) Power Cutter	143
DCF301	(AC + DC) Fan	447
DCG180	(DC) Caulking Gun	454
DCL180	(DC) Cleaner (Stick)	351
DCL184	(DC) Cleaner + Blower	349
DCL280	(DC) Cleaner (Stick)	351
DCL281	(DC) Cleaner (Stick)	351
DCL286F	(DC) Cleaner (Stick + cyclone)	351
DCL501	(DC) Cleaner (Cyclone)	347
DCM501	(DC) Coffee Maker	431
DCO181	(DC) Cut-Out Tool	261
DCS553	(DC) Metal Cutter	147
DCU180	(DC) Wheel Barrow	408
DCU601	(DC) Wheel Barrow	409
DCU602	(DC) Wheel Barrow	409
DCV200	(DC) Heated Vest	434
DCW180	(AC) (DC) Warmer Cooler Box	430
DDA351	(DC) Angle Drill	040
DDA450	(DC) Angle Drill	039
DDA460	(DC) Angle Drill	039
DDF453	(DC) Driver Drill	032
DDF481	(DC) Driver Drill	032
DDF483	(DC) Driver Drill	033
DDF484	(DC) Driver Drill	032
DDF486	(DC) Driver Drill	031
DDF487	(DC) Driver Drill	033
DDF489	(DC) Driver Drill	032
DDG460	(DC) Driver Earth Auger	408
DDG461	(DC) Driver Earth Auger	408
DF001DW	(DC) Screwdriver	053
DF001G	(DC) Driver Drill	031
DF002G	(DC) Driver Drill	031
DF012DSJ	(DC) Driver Drill	034
DF0300	Driver Drill	034
DF332D	(DC) Driver Drill	033
DF333D	(DC) Driver Drill	033
DFJ206	(DC) Fan Jacket	433
DFJ207	(DC) Fan Jacket	433
DFJ212	(DC) Fan Jacket	432
DFJ213	(DC) Fan Jacket	432
DFJ214	(DC) Fan Jacket	432
DFJ304	(DC) Fan Jacket	433
DFJ405	(DC) Fan Jacket	433
DFJ407	(DC) Fan Jacket	433
DFN350	(DC) Brad Nailer	323
DFR550	(DC) Autofeed Screwdriver	055
DFR551	(DC) Autofeed Screwdriver	054
DFS250	(DC) Screwdriver	052
DFS452	(DC) Screwdriver	052
DFV210	(DC) Fan Vest	432
DG001G	(DC) Earth Auger	407



DG002G	(DC) Earth Auger	407
DGA452	(DC) Angle Grinder	174
DGA454	(DC) Angle Grinder	174
DGA455	(DC) Angle Grinder	174
DGA456	(DC) Angle Grinder	173
DGA458	(DC) Angle Grinder	173
DGA469	(DC) Angle Grinder	167
DGA519	(DC) Angle Grinder	167
DGA700	(DC) Angle Grinder	172
DGA701	(DC) Angle Grinder	173
DGA900	(DC) Angle Grinder	172
DGA901	(DC) Angle Grinder	173
DGD800	(DC) Die Grinder	187
DGP180	(DC) Grease Gun	453
DHG181	(DC) Heat Gun	330
DHK180	(DC) Power Scraper	121
DHP453	(DC) Percussion Driver Drill	036
DHP481	(DC) Percussion Driver Drill	035
DHP484	(DC) Percussion Driver Drill	036
DHP486	(DC) Percussion Driver Drill	035
DHP487	(DC) Percussion Driver Drill	036
DHP489	(DC) Percussion Driver Drill	036
DHR171	(DC) Combination Hammer	107
DHR182	(DC) Combination Hammer	107
DHR183	(DC) Rotary Hammer	107
DHR202	(DC) Combination Hammer	106
DHR242	(DC) Combination Hammer	106
DHR263	(DC) Combination Hammer	106
DHR280	(DC) Combination Hammer	106
DHR281	(DC) Combination Hammer	105
DHR283	(DC) Combination Hammer	105
DHR400N	(DC) Combination Hammer	105
DHS660	(DC) Circular Saw	249
DHS661	(DC) Circular Saw	249
DHS680	(DC) Circular Saw	250
DHS783	(DC) Circular Saw	249
DHS900	(DC) Circular Saw	249
DHW080	(DC) High Pressure Washer	365
DJN161	(DC) Nibbler	155
DJR185	(DC) Reciprocating Saw	259
DJR187	(DC) Reciprocating Saw	259
DJR189	(DC) Reciprocating Saw	259
DJR360	(DC) Reciprocating Saw	258
DJS101	(DC) Metal Shear	153
DJS131	(DC) Metal Shear	154
DJS200	(DC) Metal Shear	153
DJS800	(DC) Cement Shear	154
DJV180	(DC) Jig Saw	255
DJV184	(DC) Jig Saw	255
DKP180	(DC) Planer	292
DKP181	(DC) Planer	292
DKT360	(DC) Kettle	431
DLM330	(DC) Lawn Mower	396
DLM382	(DC) Lawn Mower	396
DLM431	(DC) Lawn Mower	395
DLM460	(DC) Lawn Mower	395
DLM480	(DC) Lawn Mower	395
DLM481	(DC) Lawn Mower	395
DLM531	(DC) Lawn Mower	394
DLM532	(DC) Lawn Mower	394
DLM533	(DC) Lawn Mower	393
DLM538	(DC) Lawn Mower	394
DLM539	(DC) Lawn Mower	394
DLS111	(DC) Slide Compound Miter Saw	242
DLS211	(DC) Slide Compound Miter Saw	241
DLS600	(DC) Compound Miter Saw	242
DLS713	(DC) Slide Compound Miter Saw	242
DLS714	(DC) Slide Compound Miter Saw	242
DLW140	(DC) Portable Cut-off	149
DLX2466X	LXT Combo Kit	455
DMC300	(DC) Compact Cutter	147
DML805	(AC + DC) Worklight	440
DML807	(DC) Flashlight	441
DML809	(AC + DC) Worklight	440
DML810	(AC + DC) Worklight	438
DML811	(AC + DC) Worklight	440
DML812	(DC) Flashlight	442
DML814	(DC) Worklight	438
DML815	(DC) Flashlight	442
DML816	(DC) Flashlight	441
DML817	(DC) Flashlight	443
DMP180	(DC) Inflator	435
DMP181	(DC) Inflator	434
DMR055	(DC) Lantern Radio	444
DMR116	(AC + DC) Radio	445
DMR200	(DC) Speaker	445
DMR300	(DC) Speaker	445
DP2010	Drill	041
DP4700	Drill	042
DPB180	(DC) Portable Band Saw	148
DPB183	(DC) Portable Band Saw	148
DPJ180	(DC) Plate Joiner	294
DPO600	(DC) Random Orbit Polisher	218
DPP200	(DC) Hole Puncher	153
DPT351	(DC) Pin Nailer	324
DPT353	(DC) Pin Nailer	324
DPV300	(DC) Polisher	218
DRC200	(DC) Robotic Cleaner	348
DRC300	(DC) Robotic Cleaner	348
DRS780	(DC) Rear Handle Saw	253
DRT50	(DC) Trimmer	295
DRV150	(DC) Rivet Gun	055
DS4011	Drill	042
DS5000	Drill	043
DSC102	(DC) Threaded Rod Cutter	152
DSC121	(DC) Threaded Rod Cutter	152
DSC163	(DC) Steel Rod Cutter	151
DSC251	(DC) Steel Rod Cutter	151
DSD180	(DC) Drywall Cutter	261
DSL800	(DC) Drywall Sander	229
DSL801	(DC) Drywall Sander	229
DSP600	(DC) Circular Saw	254
DSP601	(DC) Circular Saw	253
DST112	(DC) Stapler	325
DST221	(DC) Stapler	325
DTD153	(DC) Impact Driver	049
DTD172	(DC) Impact Driver	049
DTM52	(DC) Multi Tool	283
DTP141	(DC) Impact Driver	049
DTR181	(DC) Rebar Tying Tool	452
DTS141	(DC) Oil Pulse Impact Driver	049
DTW1001	(DC) Impact Wrench	057
DTW181	(DC) Impact Wrench	057
DTW300	(DC) Impact Wrench	057
DTW701	(DC) Impact Wrench	057
DUA301	(DC) Telescopic Pole Saw	376
DUB184	(DC) Blower	401
DUB185	(DC) Blower	401
DUB187	(DC) Blower + Vacuum	400
DUB361	(DC) Blower	400
DUB362	(DC) Blower	399
DUB363	(DC) Blower + Vacuum	400
DUC101	(DC) Pruning Saw	374
DUC252	(DC) Chain Saw	373
DUC254	(DC) Chain Saw	374
DUC307	(DC) Chain Saw	374
DUC405	(DC) Chain Saw	373
DUH507	(DC) Hedge Trimmer	379
DUH551	(DC) Hedge Trimmer	378
DUH606	(DC) Hedge Trimmer	380
DUH607	(DC) Hedge Trimmer	379
DUH751	(DC) Hedge Trimmer	379
DUH754S	(DC) Hedge Trimmer	379
DUM111	(DC) Grass Trimmer	383
DUM604	(DC) Grass Trimmer	383
DUN461	(DC) Pole Hedge Trimmer	382
DUN500W	(DC) Pole Hedge Trimmer	382
DUP362	(DC) Pruning Shear	376
DUR189	(DC) Grass Trimmer	388
DUR190	(DC) Grass Trimmer	388
DUR192L	(DC) Grass Trimmer	387
DUR193	(DC) Grass Trimmer	388
DUR194	(DC) Grass Trimmer	387
DUR364L	(DC) Grass Trimmer	387
DUR369A	(DC) Grass Trimmer	387
DUR369N	(DC) Grass Trimmer	386
DUS054	(DC) Sprayer	406
DUS108Z	(DC) Sprayer	405
DUS158Z	(DC) Sprayer	405
DUT130	(DC) Mixer	139
DUX18	(DC) Multi-Function Power Head	371
DUX60	(DC) Multi-Function Power Head	371
DVC150L	(AC + DC) Vacuum Cleaner	343
DVC154L	(DC) Vacuum Cleaner	342
DVC157L	(DC) Vacuum Cleaner	242
DVC261	(DC) Backpack Vacuum Cleaner	346
DVC265	(DC) Backpack Dust Extractor	346
DVC350	(DC) Vacuum Cleaner	349
DVC560	(DC) Upright Vacuum Cleaner	347
DVC660	(DC) Backpack Vacuum Cleaner	346
DVC665	(DC) Backpack Dust Extractor	346
DVC750L	(DC) Vacuum Cleaner / Blower	349
DVC860L	(AC + DC) Vacuum Cleaner	343
DVC864L	(DC) Vacuum Cleaner	342
DVF104	(DC) Sprayer	406
DVP181	(DC) Vacuum Pump	454
DWD181	(DC) Wall Scanner	453
DWR180	(DC) Ratchet Wrench	058
DWT310	(DC) Shear Wrench	059
<b>E</b>		
EA3502S40B	Petrol Chain saw	375
EA6100P	Petrol Chain saw	375
EB7660TH	Backpack Petrol Blower	402
EE2650H	Petrol Edger	389
EG2850A	Generator	410
EG4550A	Generator	411
EG5550A	Generator	411
EH7500S	Petrol Hedge Trimmer	380
EH7500W	Petrol Hedge Trimmer	380
EK7301WS	Power Cutter	144
EK7650H	Power Cutter	144
EK7651H	Power Cutter	144
EK8100WS	Power Cutter	143
ELM3320	Lawn Mower	396
ELM3720	Lawn Mower	396
EM2650UH	Petrol Brush Cutter	389
EM4350RH	Backpack Petrol Brush Cutter	389
EN4950H	Petrol Pole Hedge Trimmer	382

EZH2000	Backpack Petrol Sprayer	406	GA9030	Angle Grinder	185	HR010G	(DC) Combination Hammer	104
<b>F</b>			GA9040S	Angle Grinder	185	HR166D	(DC) Rotary Hammer	107
FN001G	(DC) Brad Nailer	323	GA9050	Angle Grinder	183	HR1841F	Rotary Hammer	108
FS2300	Drywall Screwdriver	054	GA9050R	Angle Grinder	184	HR2010	Rotary Hammer	108
FS2500	Screwdriver	053	GA9062	Angle Grinder	184	HR2020	Rotary Hammer	108
FS2700	Screwdriver	053	GA9063	Angle Grinder	185	HR2475	Combination Hammer	108
FS4300	Drywall Screwdriver	054	GA9070	Angle Grinder	186	HR2600	Rotary Hammer	109
FS6300	Drywall Screwdriver	054	GA9080	Angle Grinder	186	HR2630	Combination Hammer	109
<b>G</b>			GB602	Bench Grinder	190	HR2630T	Combination Hammer	109
GA004G	(DC) Angle Grinder	168	GB800	Bench Grinder	190	HR2630X7	Rotary Hammer	109
GA005G	(DC) Angle Grinder	168	GB801	Bench Grinder	190	HR2631F	Combination Hammer	111
GA012G	(DC) Angle Grinder	169	GD0600	Die Grinder	187	HR2631FT	Combination Hammer	111
GA013G	(DC) Angle Grinder	169	GD0602	Die Grinder	187	HR2661	Combination Hammer	111
GA022G	(DC) Angle Grinder	169	GD0603	Die Grinder	187	HR2663	Combination Hammer	111
GA023G	(DC) Angle Grinder	169	GD0800C	Die Grinder	188	HR2810	Combination Hammer	112
GA028G	(DC) Angle Grinder	170	GD0801C	Die Grinder	188	HR3011FCW	Combination Hammer	112
GA029G	(DC) Angle Grinder	170	GD0810C	Die Grinder	188	HR3012FCW	Combination Hammer	112
GA035G	(DC) Angle Grinder	171	GD0811C	Die Grinder	188	HR3200C	Combination Hammer	112
GA036G	(DC) Angle Grinder	171	GS5000	Straight Grinder	189	HR3210C	Combination Hammer	113
GA037G	(DC) Angle Grinder	171	GS6000	Straight Grinder	189	HR3530	Rotary Hammer	113
GA038G	(DC) Angle Grinder	171	GV6010	Disc Sander	221	HR3540C	Combination Hammer	113
GA040G	(DC) Angle Grinder	166	GV7000C	Disc Sander	221	HR3541FC	Combination Hammer	113
GA041G	(DC) Angle Grinder	166	<b>H</b>			HR4001C	Rotary Hammer	114
GA046G	(DC) Angle Grinder	166	HB350	Electro Magnetic Drill	047	HR4003C	Rotary Hammer	114
GA047G	(DC) Angle Grinder	167	HB500	Electro Magnetic Drill	047	HR4013C	Rotary Hammer	114
GA049G	(DC) Angle Grinder	170	HG5030	Heat Gun	330	HR4030C	Rotary Hammer	115
GA050G	(DC) Angle Grinder	170	HG6030K	Heat Gun	330	HR4501C	Rotary Hammer	115
GA4030	Angle Grinder	177	HG6530V	Heat Gun	331	HR4511C	Rotary Hammer	115
GA4034	Angle Grinder	177	HG6531CK	Heat Gun	330	HR5202C	Rotary Hammer	115
GA4040CZ	Angle Grinder	181	HK0500	Power Scraper	121	HR5212C	Rotary Hammer	116
GA4040Z	Angle Grinder	179	HK1820	Power Scraper	121	HS004G	(DC) Circular Saw	248
GA4050	Angle Grinder	180	HM001G	Chipping Hammer	117	HS009G	(DC) Circular Saw	248
GA4530	Angle Grinder	177	HM002G	Demolition Hammer	117	HS011G	(DC) Circular Saw	248
GA4540CZ	Angle Grinder	181	HM0810T	Chipping Hammer	117	HS012G	(DC) Circular Saw	248
GA4540Z	Angle Grinder	179	HM0870C	Chipping Hammer	118	HS0600	Circular Saw	251
GA4550	Angle Grinder	180	HM0871C	Chipping Hammer	117	HS301D	(DC) Circular Saw	250
GA4550R	Angle Grinder	181	HM1101C	Demolition Hammer	118	HS7010	Circular Saw	251
GA4591	Angle Grinder	182	HM1111C	Demolition Hammer	118	HW1200	High Pressure Cleaner	366
GA4592	Angle Grinder	182	HM1203C	Demolition Hammer	118	HW1300	High Pressure Cleaner	366
GA4594	Angle Grinder	182	HM1213C	Demolition Hammer	119	HW132	High Pressure Cleaner	366
GA4595	Angle Grinder	183	HM1214C	Demolition Hammer	119	HW151	High Pressure Cleaner	366
GA5010	Angle Grinder	179	HM1307C	Demolition Hammer	119	<b>J</b>		
GA5011	Angle Grinder	179	HM1317C	Demolition Hammer	119	JN1601	Nibbler	155
GA5030	Angle Grinder	177	HM1511	Demolition Hammer	120	JN3201	Nibbler	155
GA5034	Angle Grinder	177	HM1802	Breaker	120	JR001G	(DC) Recipro Saw	258
GA5040CZ	Angle Grinder	181	HM1812	Breaker	120	JR002G	(DC) Recipro Saw	258
GA5040Z	Angle Grinder	179	HP001G	(DC) Percussion Driver Drill	035	JR105D	(DC) Recipro Saw	259
GA5050	Angle Grinder	180	HP002G	(DC) Percussion Driver Drill	035	JR3051T	Recipro Saw	260
GA5050R	Angle Grinder	181	HP0300	Percussion Driver Drill	037	JR3061T	Recipro Saw	260
GA5080R	Angle Grinder	167	HP1230	Impact Drill	044	JR3070CT	Recipro Saw	260
GA5091	Angle Grinder	182	HP1630K	Impact Drill	045	JS1601	Straight Metal Shear	154
GA5092	Angle Grinder	182	HP1640K	Impact Drill	045	JS1602	Metal Shear	154
GA5094	Angle Grinder	182	HP1640KX2	Impact Drill	045	JS3201	Metal Shear	155
GA5095	Angle Grinder	183	HP1640KX3	Impact Drill	045	JV001G	(DC) Jig Saw	254
GA6010	Angle Grinder	179	HP2000	Impact Drill	046	JV101D	(DC) Jig Saw	256
GA7001	Angle Grinder	183	HP2010N	Impact Drill	046	JV102D	(DC) Jig Saw	255
GA7020	Angle Grinder	184	HP2050	Impact Drill	046	JV103D	(DC) Jig Saw	255
GA7030	Angle Grinder	185	HP2070	Impact Drill	046	<b>K</b>		
GA7040S	Angle Grinder	185	HP332D	(DC) Percussion Driver Drill	037	KP001G	(DC) Power Planer	292
GA7050	Angle Grinder	183	HP333D	(DC) Percussion Driver Drill	037	KP0800XK	Power Planer	293
GA7050R	Angle Grinder	184	HR002G	(DC) Combination Hammer	103	KP0810K	Power Planer	293
GA7062	Angle Grinder	184	HR003G	(DC) Combination Hammer	103	KT001G	(DC) Kettle	431
GA7063	Angle Grinder	185	HR005G	(DC) Rotary Hammer	102	<b>L</b>		
GA7070	Angle Grinder	186	HR006G	(DC) Rotary Hammer	102	LB1200F	Band saw	246
GA7080	Angle Grinder	186	HR007G	(DC) Combination Hammer	103	LC1230	Metal Cutting Saw	149
GA9020	Angle Grinder	184	HR008G	(DC) Combination Hammer	103	LD030P	Laser Distance Measure	337

LD050P	Laser Distance Measure	336
LD080PI	Laser Distance Measure	336
LF1000	Flip Over saw	245
LH1040	Table Top Miter Saw	245
LH1201FL	Table Top Miter Saw	245
LM001C	(DC) Lawn Mower	392
LM001J	(DC) Lawn Mower	392
LM002G	(DC) Lawn Mower	393
LM002J	(DC) Lawn Mower	391
LM004J	(DC) Lawn Mower	391
LS002G	(DC) Slide Compound Miter Saw	241
LS003G	(DC) Slide Compound Miter Saw	241
LS004G	(DC) Slide Compound Miter Saw	241
LS0714	Slide Compound Miter Saw	244
LS0815FL	Slide Compound Miter Saw	243
LS1018LN	Slide Compound Miter Saw	243
LS1019L	Slide Compound Miter Saw	243
LS1040	Slide Compound Miter Saw	244
LS1219L	Slide Compound Miter Saw	243
LS1440	Miter Saw	244
LW1400	Portable Cut-off	149
LW1401	Portable Cut-off	150
<b>M</b>		
ML001G	(DC) Flashlight	442
ML002G	(DC) Flashlight/Lantern	441
ML003G	(DC) Worklight	439
ML005G	(DC) Worklight	439
ML006G	(DC) Flashlight	441
ML007G	(DC) Flashlight	442
ML009G	(DC) Worklight	439
ML010G	(DC) Worklight	438
ML011G	(DC) Flashlight	443
ML103	(DC) Flashlight	443
ML106	(DC) Flashlight	443
MLS100N	Miter Saw	244
MLT100N	Table Saw	246
MP001G	(DC) Inflator	434
MP100D	(DC) Inflator	435
MR001G	(AC + DC) Radio	444
MR006G	(Ac + DC) Radio	444
MR052	(DC) Radio	445
MW001G	(DC) Microwave	430
<b>N</b>		
N1900BK	Power Planer	292
N1923BK	Power Planer	293
N5900B	Circular Saw	251
N9500N	Angle Grinder	176
NHP1320S	Impact Drill	044
<b>P</b>		
PB002G	(DC) Band saw	148
PC5000C	Concrete Planer	191
PC5001C	Concrete Planer	191
PC5010C	Concrete Planer	191
PJ7000	Plate Joiner	294
PLM4120N	Petrol Lawn Mower	397
PLM4620N2	Petrol Lawn Mower	397
PLM4621N2	Petrol Lawn Mower	397
PLM5113N2	Petrol Lawn Mower	397
PM001G	(DC) Backpack Mist Blower	405
PM7650H	Backpack Petrol Mist Blower	405
PO6000C	Random Orbit Polisher	219
PT001G	(DC) Pin Nailer	324
PT354D	(DC) Pin Nailer	324
PV001G	(DC) Polisher	218
PV301D	(DC) Polisher	218
PV7000C	Polisher	219

<b>R</b>		
RP0900	Router (Plunge Type)	296
RP1800	Router (Plunge Type)	296
RP2300FC	Router (Plunge Type)	296
RS001G	(DC) Rear Handle Saw	252
RS002G	(DC) Rear Handle Saw	252
RST250	Petrol String Trimmer	389
RT001G	(DC) Trimmer	295
RT0700C	Trimmer	296
RT0702C	Trimmer	295
<b>S</b>		
SA7000C	Angle Sander	220
SA7021	Angle Sander	220
SC103D	(DC) Threaded Rod Cutter	152
SD100D	(DC) Drywall Cutter	261
SG1250	Wall Chaser	146
SG1251J	Wall Chaser	146
SJ401	Scroll Saw	260
SK105D	(DC) Cross Line Laser Level	335
SK105GD	(DC) Cross Line Laser Level	335
SK106D	(DC) 4 point Cross Line Laser Level	335
SK106GD	(DC) 4 point Cross Line Laser Level	335
SK312GD	(DC) Green Multi line Laser	333
SK40GD	(DC) Green Multi line Laser	333
SK700D	(DC) Multi line Laser	334
SK700GD	(DC) Green Multi line Laser	334
SKR200Z	(DC) Rotary Laser Level	337
SKR301	(DC) Rotary Laser Level	337
SP001G	(DC) Plunge Cut Circular Saw	253
SP6000	Plunge Cut Circular Saw	254
ST113D	(DC) Stapler	325
<b>T</b>		
TB131	Drill Press	043
TD001G	(DC) Impact Driver	048
TD002G	(DC) Impact Driver	048
TD003G	(DC) Impact Driver	048
TD0101	Impact Driver	050
TD022DSJ	(DC) Impact Driver	051
TD111D	(DC) Impact Driver	050
TD112D	(DC) Impact Driver	050
TL064D	(DC) Angle Impact Driver	050
TL065D	(DC) Angle Impact Wrench	058
TM3010CK	Multi Tool	283
TM30D	(DC) Multi Tool	283
TW001G	(DC) Impact Wrench	056
TW005G	(DC) Impact Wrench	056
TW008G	(DC) Impact Wrench	056
TW0350	Impact Wrench	059
TW1000	Impact Wrench	059
TW161D	(DC) Impact Wrench	058
<b>U</b>		
UA004G	(DC) Telescopic Pole Saw	376
UB001C	(DC) Blower	399
UB001G	(DC) Blower	399
UB002C	(DC) Backpack Blower	399
UB100D	(DC) Blower	401
UB1102	Blower	402
UB1103	Blower	401
UC002G	(DC) Chain Saw	373
UC012G	(DC) Chain Saw	373
UC100D	(DC) Pruning Saw	374
UC4041A	Chain Saw	375
UC4551A	Chain Saw	375
UH005G	(DC) Hedge Trimmer	378
UH007G	(DC) Hedge Trimmer	378
UH014G	(DC) Hedge Trimmer	378

UH5261	Hedge Trimmer	381
UH6570	Hedge Trimmer	381
UH7580	Hedge Trimmer	381
UM600D	(DC) Grass Shear	383
UN460WD	(DC) Pole Hedge Trimmer	382
UP100D	(DC) Pruning Shear	376
UR003G	(DC) Grass Trimmer	386
UR006G	(DC) Grass Trimmer	386
UR007G	(DC) Grass Trimmer	386
UR012G	(DC) Grass Trimmer	385
UR013G	(DC) Grass Trimmer	385
UR100D	(DC) String Trimmer	388
UR101C	(DC) Grass Trimmer	385
UR201C	(DC) Grass Trimmer	385
US053D	(DC) Sprayer	406
UT001G	(DC) Mixer	139
UT1305	Mixer	139
UT1400	Mixer	140
UT2204	Mixer	139
UX01G	(DC) Multi Function Power Head	371
<b>V</b>		
VC003GL	(DC) Vacuum Cleaner	342
VC004GL	(DC) Vacuum Cleaner	342
VC005GL	(DC) Vacuum Cleaner	342
VC007GL	(DC) Vacuum Cleaner	342
VC008G	(DC) Backpack Vacuum Cleaner	345
VC009G	(DC) Backpack Vacuum Cleaner	345
VC2000L	Vacuum Cleaner	343
VC3210LX1	Vacuum Cleaner	344
VC3211HX1	Vacuum Cleaner	344
VR001G	(DC) Vibrator	140
VR002C	(DC) Vibrator	140
VR004C	(DC) Vibrator	140
<b>W</b>		
WR100D	(DC) Ratchet Wrench	058
WUT02	AWS Adapter	343

# NEW TOOLS

## DRILLING / FIXING



CORDLESS DRIVER DRILL  
**DDF489** (13mm)  
18V | **LXT**

Pg. 032



CORDLESS PERCUSSION DRIVER DRILL  
**DHP489** (13mm)  
18V | **LXT**

Pg. 036



CORDLESS DRIVER DRILL  
**TD002G / TD003G**  
40V MAX | **XGT**

Pg. 048

## CONCRETE DRILLING DEMOLITION



CORDLESS COMBI HAMMER  
**HR010G** (20mm)  
40V MAX | **XGT**

Pg. 104



CORDLESS COMBI HAMMER  
**DHR183** (18mm)  
18V | **LXT**

Pg. 107

## MIXING / STIRRING



CORDLESS MIXER  
**UT001G** (240 mm)  
40V MAX | **XGT**

Pg. 139



CORDLESS CONCRETE VIBRATOR  
**VR002C** (43 mm)  
**VR004C** (52 mm)

Pg. 140

## CUTTING CONCRETE / METAL



CORDLESS POWER CUTTER  
**CE002G** (355 mm)  
80V MAX | **XGT**

Pg. 143



CORDLESS COMPACT CUTTER  
**DMC300** (76 mm)  
18V | **LXT**

Pg. 147

## GRINDING



CORDLESS GRINDER  
**GA049G** (115mm)  
**GA050G** (125mm)  
40V MAX | **XGT**

Pg. 170



AC GRINDER  
**GA4591** (115mm)  
**GA5091** (125mm)

Pg. 182



AC GRINDER  
**GA4592** (115mm)  
**GA5092** (125mm)

Pg. 182



AC GRINDER  
**GA4594** (115mm)  
**GA5094** (125mm)

Pg. 182



AC GRINDER  
**GA4595** (115mm)  
**GA5095** (125mm)

Pg. 183



AC GRINDER  
**GA7080** (180mm)  
**GA9080** (230mm)

Pg. 186

## SAWING



AC GRINDER  
**GA7070** (180mm)  
**GA9070** (230mm)

Pg. 186



CORDLESS CIRCULAR SAW (165mm)  
**HS012G**  
40V MAX | **XGT**

Pg. 248



CORDLESS JIG SAW  
**JV001G**  
40V MAX | **XGT**

Pg. 254



CORDLESS RECIPRO SAW  
**DJR189**  
18V | **LXT**

Pg. 259

## HEAT GUN



HEAT GUN  
**HG5030**

Pg. 330

## CLEANING



CORDLESS VACUUM CLEANER (40L)  
**VC007GL**  
80V MAX | **XGT**

Pg. 342



CORDLESS ROBOTIC CLEANER  
**DRC300**  
18V | **LXT**

Pg. 348



CORDLESS STICK CLEANER (CYCLONE TYPE)  
**DCL286F**  
18V | **LXT**

Pg. 351



CORDLESS STICK CLEANER (CAPSULE TYPE)  
**DCL280F**  
18V | **LXT**

Pg. 351



CORDLESS STICK CLEANER (CAPSULE TYPE)  
**CL117FD**  
12V MAX | IN-BUILT

Pg. 351

**OPE**



CORDLESS CHAIN SAW  
**DUC307** (300 mm)  
18V | **LXT**

Pg. 374



CORDLESS PRUNING SAW  
**DUC101** (100 mm)  
18V | **LXT**

Pg. 374



CORDLESS PRUNING SAW  
**UC100D** (100 mm)  
12V MAX | **XGT**

Pg. 374



CORDLESS PRUNER  
**UP100D** (25 mm)  
12V MAX | **XGT**

Pg. 376



CORDLESS HEDGE TRIMMER  
**DUH507** (500 mm)  
**DUH607** (600 mm)  
18V | **LXT**

Pg. 379



CORDLESS HEDGE TRIMMER  
**DUH606** (600 mm)  
18V | **LXT**

Pg. 380



CORDLESS BRUSH CUTTER  
**URO13G** (450 mm)  
40V MAX | **XGT**

Pg. 385



CORDLESS LAWN MOWER  
**LM004** (534 mm)  
64V MAX

Pg. 391



CORDLESS LAWN MOWER  
**LM002G** (534 mm)  
40V MAX | **XGT**

Pg. 393



CORDLESS BACKPACK BLOWER  
**UB002C**  
36V | **XGT**

Pg. 399



CORDLESS BLOWER + VACUUM  
**DUB187**  
18V | **LXT**

Pg. 400



CORDLESS DUST BLOWER + INFLATOR  
**DAS180**  
18V | **LXT**

Pg. 403



CORDLESS MIST BLOWER  
**PM001G** (15 L)  
40V MAX | **XGT**

Pg. 405



CORDLESS SPRAYER  
**DUS108** (10 L)  
**DUS158** (15 L)  
18V | **LXT**

Pg. 405



CORDLESS EARTH AUGER  
**DG002G** (200 mm)  
40V MAX | **XGT**

Pg. 407



CORDLESS EARTH AUGER  
**DDG461** (200 mm)  
18Vx2 | **LXT**

Pg. 408



CORDLESS WHEEL BARROW  
**DCU602** (BUCKET TRAY)  
18Vx2 | **LXT**

Pg. 409



CORDLESS WHEEL BARROW  
**DCU601** (FLAT TRAY)  
18Vx2 | **LXT**

Pg. 409

**JOBSITE TOOLS**



CORDLESS COOLER / WARMER BOX  
**CW002G** (50 L)  
**CW004G** (29 L)  
**CW003G** (7 L)  
40V MAX | **XGT** 18V | **LXT** **CE**

Pg. 429 - 430



CORDLESS MICROWAVE OVEN  
**MW001G** (8L)  
40V MAX | **XGT**

Pg. 430



CORDLESS WORKLIGHT  
**ML010G** (5,500 lm)  
40V MAX | **XGT**  
18V | **LXT** **CE**

Pg. 438



CORDLESS WORKLIGHT  
**ML009G** (10,000 lm)  
40V MAX | **XGT**  
18V | **LXT**

Pg. 439



CORDLESS WORKLIGHT  
**ML005G** (3,600 lm)  
40V MAX | **XGT**  
18V | **LXT**

Pg. 439



CORDLESS FLASHLIGHT  
**DML807** (710 lm)  
18V | **LXT**

Pg. 441



CORDLESS FLASHLIGHT  
**ML011G** (300 lm)  
40V MAX | **XGT**  
**DML817** (300 lm)  
18V | **LXT**

Pg. 443



CORDLESS LANTERN + RADIO  
**DMR055**  
18V | **LXT**

Pg. 444



CORDLESS RADIO  
**MR001G**  
40V MAX | **XGT**  
18V | **LXT**  
12V MAX | **XGT**

Pg. 444



CORDLESS RADIO  
**DMR116**  
18V | **LXT**  
**AC**

Pg. 445



CORDLESS FAN  
**CF003G**  
40V MAX | **XGT**  
18V | **LXT**  
**AC**

Pg. 446

**SPECIALITY TOOLS**



ADAPTER  
**ADP08**  
12V MAX | **XGT**

Pg. 449



CORDLESS REBAR TYING TOOL  
**DTR181**  
18V | **LXT**

Pg. 452



CORDLESS AIR COMPRESSOR  
**AC001G**  
40V MAX | **XGT**

Pg. 454

# NEW ACCESSORIES

## BATTERY / CHARGERS



64V MAX  
Lithium-ion  
Battery 10.Ah  
**BL64100**  
**191Y69-6**

Pg. 024



XGT Two Port  
Charger  
**DC40WA**

Pg. 024



LXT Single Port  
Economy Charger  
**DC18WC**

Pg. 025



**XGT Power  
Source Kit**  
8.Ah 2pcs Kit  
5.0Ah 1pc Kit

Pg. 028



**PDC1500**  
Portable Power  
Pack Unit

Pg. 029



**Power Converter  
BAC01**

Pg. 029



Flat Bit  
**E-17491**

Pg. 062

Flat Bit Extension Bar  
**D-77213**

Pg. 063



Masonry DrillBits  
12pcs set: **D-77126**  
8pcs set: **E-15861**  
8pcs set (Multi  
Material) : **E-15855**

Pg. 073

## FIXING



Impact Black  
Screwdriver bits  
(10pcs set)  
**E-15849**

Pg. 085



Impact Black  
Screwdriver bit  
(10pcs set)  
**E-14211**

Pg. 085



Impact Black  
Double Ended  
Screwdriver bit  
(10pcs set)

Pg. 085



Impact Black  
Screwdriver bit  
(33pcs set)  
**E-15687**

Pg. 086



Impact Black  
Screwdriver bit  
(8pcs set)  
**E-14227**

Pg. 086



Impact Black  
Screwdriver bit  
(10pcs set)  
**E-14233**

Pg. 086



Hex Screw Bits  
with 1/4"Hex Shank

Pg. 089



Impact Black  
Deep Impact Sockets

Pg. 093

## CUTTING / GRINDING / SANDING / POLISHING



355mm Metal  
Cutting Abrasive  
Wheel for Power  
Cutter  
**E-12790-5**

Pg. 156



DMC300  
Accessories  
Cut-off wheel - **D-74815-5**  
TCT blade - **D-74837**  
Diamond wheel - **D-77263**

Pg. 157



Diamond Wheel -  
Porcelain Tile  
105mm  
**D-76299**

Pg. 195

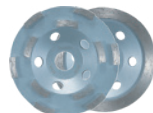

Diamond Cup  
Wheel for  
Concrete  
Planer (125mm)

Pg. 197



E- Series Thin  
Cutting Abrasive  
Wheel  
**(100 to 230mm)**

Pg. 202



Brass Coated  
Wire Brush  
with 1/4"  
Hex Shank

Pg. 084



Mounted Flap  
Wheels

Pg. 211



Abrasive Paper  
for Random Orbit  
Sander  
125mm / 150mm  
(Assorted pack)

Pg. 234

## CUTTING

## SAWING

## MULTI TOOL

## ROUTERING

## CLEANING



EFFICUT  
Saw Blade  
for LC1230 Metal  
Cutting Saw  
**(305mm)**  
**E-19788**

Pg. 158



EFFICUT  
Saw Blade  
for Cutting  
Aluminium  
**(165-216mm)**

Pg. 264



TCT Reciprosaw  
blade for Aerated  
Concrete  
**B-63591**

Pg. 276



Multi tool Blade  
(Renovation Set)  
**E-16994**

Pg. 289



22pcs Router Bit Set  
for Multiple Works  
(Assorted)  
**D-74778**

Pg. 314



22pcs Router Bit Set  
for basic grooving  
(Assorted)  
**D-74784**

Pg. 314



Stick Cleaner  
Stand  
**1911L1-0**

Pg. 353

## GARDEN TOOL ACCESSORIES

## COMBINATION SETS



Ground Trimmer  
Attachment  
**EN424MP:**  
**1913D3-2**

Pg. 412



Water Pump  
Attachment  
**PF400MP:**  
**BRAPP400MP**

Pg. 413



Blower  
Attachment  
**UB402MP:**  
**191250-7**

Pg. 413



Earth Auger Bits  
**E-series for Earth Auger**  
**D-series for Driver Drill**

Pg. 426



17pcs Drill and  
Screws Bit Set  
**D-77207**

Pg. 464



75pcs Drill &  
Screwdriver Bit Set  
**E-15110**

Pg. 468

# Cordless Range

- 64V MAX
- DIRECT CONNECT SYSTEM (used with power pack units)
- XGT (80V MAX / 40V MAX)
- LXT (36V / 18V)
- CXT (12V MAX)

**MAKITA'S TOOL RANGE IS STRONGER THAN EVER  
TOOLS IN ALL SIZES FOR EVERY APPLICATION**



**XGT**

**The cordless answer to  
high demands**

With the new 40V / 80V Max XGT series, Makita expands its range of high-quality cordless tools and continues to penetrate into areas that were previously reserved for AC-powered machines.



**LXT**

**World's largest  
18V Li-ion system**

Tool users who unplug the cord with Makita 18V LXT experience new levels of convenience, efficiency and productivity.



**CXT**

**More comfort and  
capacity**

CXT 12V Max, Compact Extreme System, gives users a more compact solution with more comfort and more capacity.

Since the Launch of 18V LXT in 2005, Makita has been leading the way in Cordless Tool innovation and technology. 18V LXT provides consumers with not only the largest range on one battery, it also provides consumers with the most reliable and efficient tools available. Our vision as a Company is to provide consumers with a battery solution for all applications across Building Construction, Industrial, Outdoor Power Equipment and Commercial Cleaning Channels In keeping with our vision. Makita is ready to lead the way once again, with our new XGT 40V / 80V battery system that will coexist with LXT, CXT and continue towards our vision of a battery solution for all applications!

# XGT

- High power
- Tough design
- Smart Technology

XGT is a new system with its own tools, batteries, and chargers. A combination of innovative tool design and higher output batteries provides a genuine solution for high demand industrial users



## XGT 80Vmax

40Vmax + 40Vmax

Makita's 80V Max system is our maximum power system of cordless tools. The increased power and performance allow XGT Cordless tools to perform better than the Coded and Petrol Engine tools



Rotary Hammer



Demolition Hammer



Vacuum Cleaner



Grass Trimmer



Power Cutter



**XGT**

# 40V Li-ion max

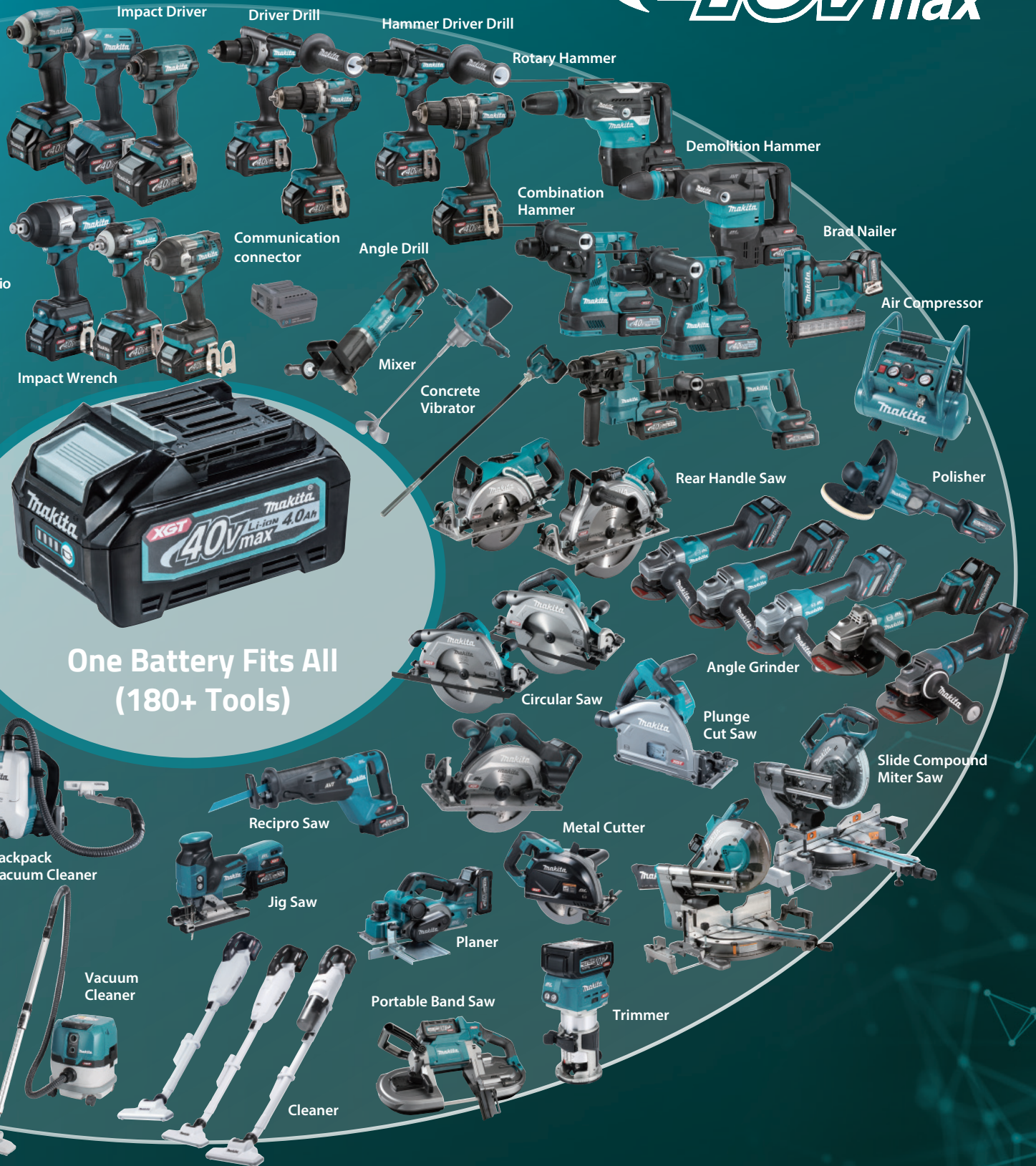

**One Battery Fits All  
(180+ Tools)**

## Battery

BL4020  
2.0Ah



BL4040 /  
BL4040F  
4.0Ah



BL4050F  
5.0Ah



BL4080F  
8.0Ah



## Charger

DC40RA



DC40RB



ADP10



Adapter for  
LXT Battery

# LXT



Portable Cut-off

Rear Handle Saw

Recipro Saw

Power Cutter

Angle Grinder

Rotary Hammer

Slide Compound Miter Saw

Combination Hammer

Circular Saw

Pin Nailer

Concrete Vibrator

Angle Drill Shear Wrench

Finish Nailer

Backpack Vacuum Cleaner

Wheelbarrow

Caulking Gun

Heat Gun

Vacuum Pump

Rebar Tying Tool

Rivet Gun

Hole Puncher

Grease Gun

Brad Nailer

Upright Cleaner

Worklight

Area Worklight

Flashlight

LED Flashlight

LED Worklight

Fan

Radio with Lantern

Worklight

Coffee Maker

Job Site Radio

Job Site Speaker



Heated Vest

Heated Base Layer Shirt

Fan Jacket

Lawn Mower

Cooler & Warmer Box

Grass Shear

Heated Jacket

Heated Blanket

Garden Sprayer

Dust Blower

Blower

Robotic Cleaner

Fan Vest

Hedge Trimmer

String Trimmer

Pruning Saw

Chain Saw

Blower Vacuum

Trimmer

Hedge Trimmer

Grass Trimmer

String Trimmer

Multi Function Power Head

Vacuum Cleaner

Portable Vacuum Cleaner

Planer

Drywall Saw

Cut-Out Tool

Belt Sander

Cleaner

Cyclone Cleaner

Plate Joiner

18v + 18v → 36v

# 18V LITHIUM-ION

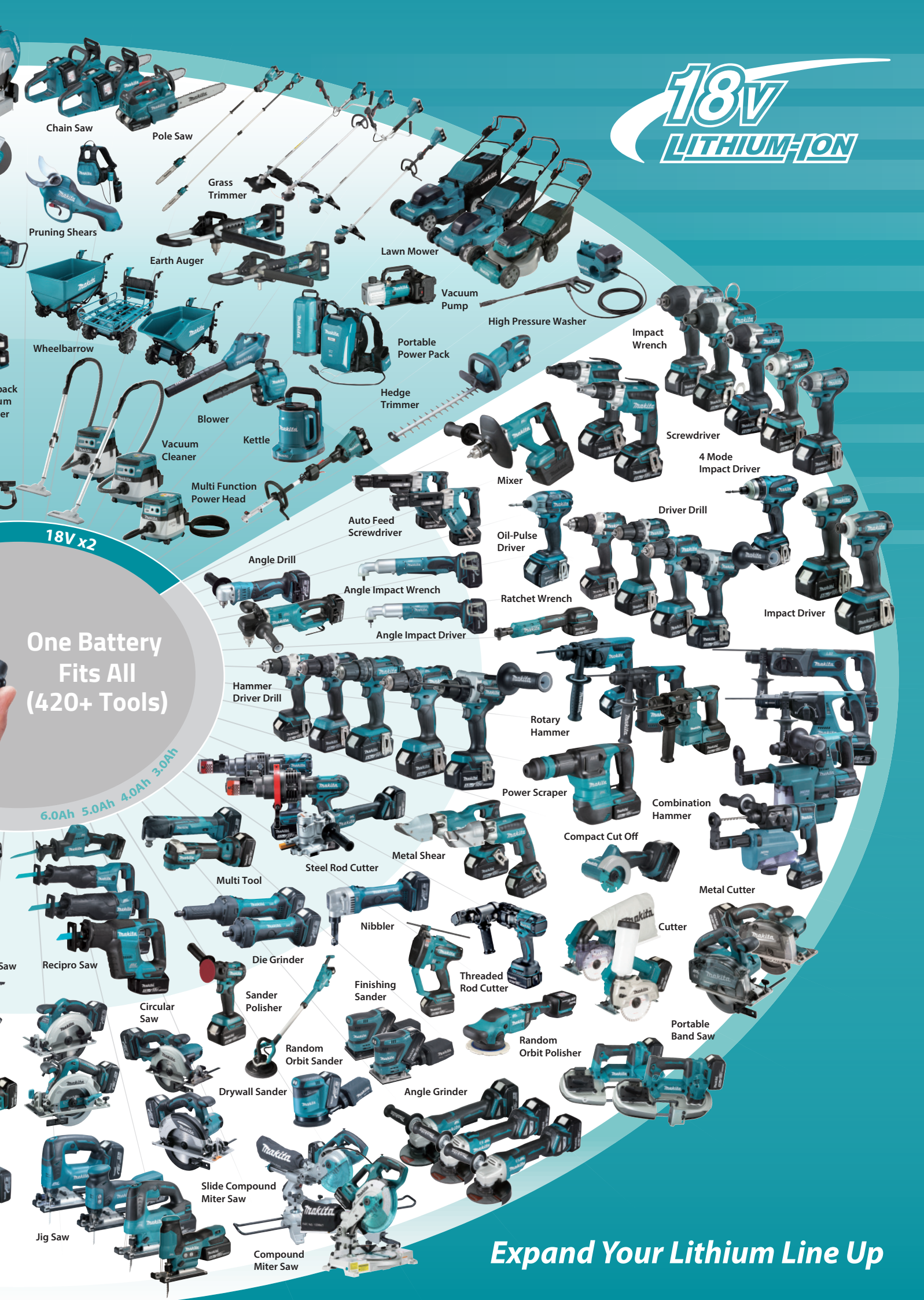

Chain Saw

Pole Saw

Grass Trimmer

Pruning Shears

Earth Auger

Lawn Mower

Vacuum Pump

High Pressure Washer

Wheelbarrow

Portable Power Pack

Impact Wrench

Blower

Hedge Trimmer

Screwdriver

4 Mode Impact Driver

Vacuum Cleaner

Kettle

Mixer

Driver Drill

Multi Function Power Head

Auto Feed Screwdriver

Oil-Pulse Driver

18V x2

Angle Drill

Angle Impact Wrench

Ratchet Wrench

Impact Driver

One Battery Fits All (420+ Tools)

Angle Impact Driver

Hammer Driver Drill

Rotary Hammer

6.0Ah 5.0Ah 4.0Ah 3.0Ah

Multi Tool

Steel Rod Cutter

Metal Shear

Power Scraper

Combination Hammer

Compact Cut Off

Metal Cutter

Recipro Saw

Multi Tool

Steel Rod Cutter

Metal Shear

Power Scraper

Combination Hammer

Compact Cut Off

Metal Cutter

Multi Tool

Steel Rod Cutter

Metal Shear

Power Scraper

Combination Hammer

Compact Cut Off

Metal Cutter

Multi Tool

Steel Rod Cutter

Metal Shear

Power Scraper

Combination Hammer

Compact Cut Off

Metal Cutter

Multi Tool

Steel Rod Cutter

Metal Shear

Power Scraper

Combination Hammer

Compact Cut Off

Metal Cutter

Multi Tool

Steel Rod Cutter

Metal Shear

Power Scraper

Combination Hammer

Compact Cut Off

Metal Cutter

Multi Tool

Steel Rod Cutter

Metal Shear

Power Scraper

Combination Hammer

Compact Cut Off

Metal Cutter

Multi Tool

Steel Rod Cutter

Metal Shear

Power Scraper

Combination Hammer

Compact Cut Off

Metal Cutter

Multi Tool

Steel Rod Cutter

Metal Shear

Power Scraper

Combination Hammer

Compact Cut Off

Metal Cutter

Multi Tool

Steel Rod Cutter

Metal Shear

Power Scraper

Combination Hammer

Compact Cut Off

Metal Cutter

Multi Tool

Steel Rod Cutter

Metal Shear

Power Scraper

Combination Hammer

Compact Cut Off

Metal Cutter

Multi Tool

Steel Rod Cutter

Metal Shear

Power Scraper

Combination Hammer

Compact Cut Off

Metal Cutter

Multi Tool

Steel Rod Cutter

Metal Shear

Power Scraper

Combination Hammer

Compact Cut Off

Metal Cutter

Multi Tool

Steel Rod Cutter

Metal Shear

Power Scraper

Combination Hammer

Compact Cut Off

Metal Cutter

Multi Tool

Steel Rod Cutter

Metal Shear

Power Scraper

Combination Hammer

Compact Cut Off

Metal Cutter

Multi Tool

Steel Rod Cutter

Metal Shear

Power Scraper

Combination Hammer

Compact Cut Off

Metal Cutter

Multi Tool

Steel Rod Cutter

Metal Shear

Power Scraper

Combination Hammer

Compact Cut Off

Metal Cutter

Multi Tool

Steel Rod Cutter

Metal Shear

Power Scraper

Combination Hammer

Compact Cut Off

Metal Cutter

Multi Tool

Steel Rod Cutter

Metal Shear

Power Scraper

Combination Hammer

Compact Cut Off

Metal Cutter

Multi Tool

Steel Rod Cutter

Metal Shear

Power Scraper

Combination Hammer

Compact Cut Off

Metal Cutter

Multi Tool

Steel Rod Cutter

Metal Shear

Power Scraper

Combination Hammer

Compact Cut Off

Metal Cutter

Multi Tool

Steel Rod Cutter

Metal Shear

Power Scraper

Combination Hammer

Compact Cut Off

Metal Cutter

Multi Tool

Steel Rod Cutter

Metal Shear

Power Scraper

Combination Hammer

Compact Cut Off

Metal Cutter

Multi Tool

Steel Rod Cutter

Metal Shear

Power Scraper

Combination Hammer

Compact Cut Off

Metal Cutter

Multi Tool

Steel Rod Cutter

Metal Shear

Power Scraper

Combination Hammer

Compact Cut Off

Metal Cutter

Multi Tool

Steel Rod Cutter

Metal Shear

Power Scraper

Combination Hammer

Compact Cut Off

Metal Cutter

Multi Tool

Steel Rod Cutter

Metal Shear

Power Scraper

Combination Hammer

Compact Cut Off

Metal Cutter

Multi Tool

Steel Rod Cutter

Metal Shear

Power Scraper

Combination Hammer

Compact Cut Off

Metal Cutter

Multi Tool

Steel Rod Cutter

Metal Shear

Power Scraper

Combination Hammer

Compact Cut Off

Metal Cutter

Multi Tool

Steel Rod Cutter

Metal Shear

Power Scraper

Combination Hammer

Compact Cut Off

Metal Cutter

Multi Tool

Steel Rod Cutter

Metal Shear

Power Scraper

Combination Hammer

Compact Cut Off

Metal Cutter

Multi Tool

Steel Rod Cutter

Metal Shear

Power Scraper

Combination Hammer

Compact Cut Off

Metal Cutter

Multi Tool

Steel Rod Cutter

Metal Shear

Power Scraper

Combination Hammer

Compact Cut Off

Metal Cutter

Multi Tool

Steel Rod Cutter

Metal Shear

Power Scraper

Combination Hammer

Compact Cut Off

Metal Cutter

Multi Tool

Steel Rod Cutter

Metal Shear

Power Scraper

Combination Hammer

Compact Cut Off

Metal Cutter

Multi Tool

Steel Rod Cutter

Metal Shear

Power Scraper

Combination Hammer

Compact Cut Off

Metal Cutter

Multi Tool

Steel Rod Cutter

Metal Shear

Power Scraper

Combination Hammer

Compact Cut Off

Metal Cutter

Multi Tool

Steel Rod Cutter

Metal Shear

Power Scraper

Combination Hammer

Compact Cut Off

Metal Cutter

Multi Tool

Steel Rod Cutter

Metal Shear

Power Scraper

Combination Hammer

Compact Cut Off

Metal Cutter

Multi Tool

Steel Rod Cutter

Metal Shear

Power Scraper

Combination Hammer

Compact Cut Off

Metal Cutter

Multi Tool

Steel Rod Cutter

Metal Shear

Power Scraper

Combination Hammer

Compact Cut Off

Metal Cutter

Multi Tool

Steel Rod Cutter

Metal Shear

Power Scraper

Combination Hammer

Compact Cut Off

Metal Cutter

Multi Tool

Steel Rod Cutter

Metal Shear

Power Scraper

Combination Hammer

Compact Cut Off

Metal Cutter

Multi Tool

Steel Rod Cutter

Metal Shear

Power Scraper

Combination Hammer

Compact

# LXT 18V + 18V → 36V

Powered by two 18V Li-ion LXT batteries in series



The Makita twin 18V battery concept offers an expanding range of machines that utilise the established 18V Lithium-ion battery capacity to deliver high power 36V performance whilst offering an economic purchase solution for existing Makita tool owners.

Note: When different capacity batteries are used together (for example, 18V Li-ion 3.0Ah and 5.0Ah, or fully charged 5.0Ah and 70% charged 5.0Ah), the machine stops when the battery with the less capacity gets empty.

# CXT

## 12V<sub>max</sub> LITHIUM-ION





# THE CORDLESS ANSWER TO HIGH DEMANDS

XGT is a new system with its own tools, batteries, and chargers

## HIGH BATTERY OUTPUT

XGT is a genuine solution for high demand Industrial applications, A combination of innovative tool design and higher output batteries, providing a genuine solution for high demand industrial users as well!

## SMART TECHNOLOGY

The XGT range of tools and batteries comes with a built-in program, that provides **digital communication between the battery and the tool**. The battery technology and the tools are engineered to work together for optimum performance.

Actively monitors and **protects the tools against overload, over-discharge and overheating.**

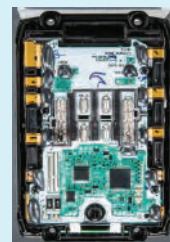

Battery charge level with 4 bright green L.E.D. indicators allows the user to clearly see charge level.

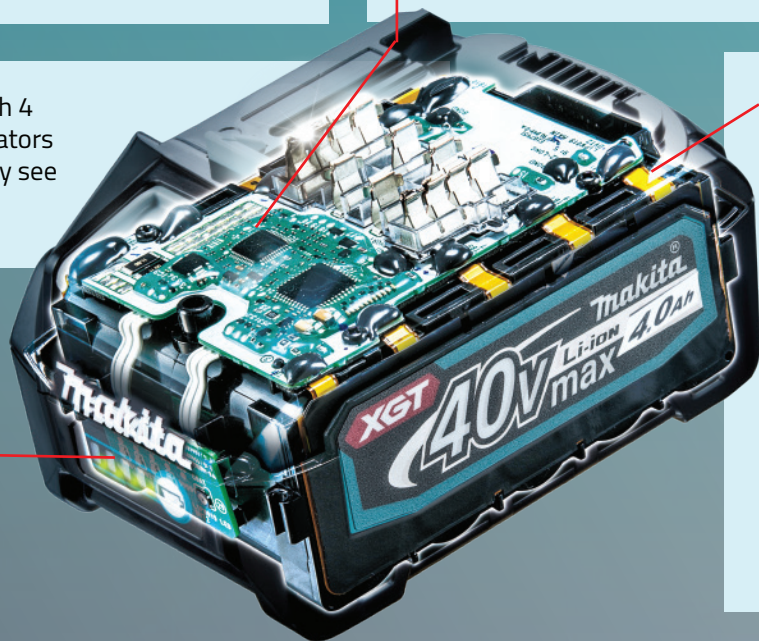

## BUILT TOUGH

Durable rails which hold them securely in place when using the new high power products.

**Wetguard & IPX4** Water and dust-resistant triple layer structure and an enhanced terminal structure are engineered to protect against water and dust for any job site condition.

Heavy-duty outer casing and cell holder for better shock resistance.



# Optimum Charging System

## Rapid Optimum Charger

It is necessary to cool down before start charging when the battery temperature is high. Built-in fan circulates air through the battery before start charging and during the charging process to cool the battery for faster charge time.

The Makita Rapid Optimum Charger communicates with the battery's built-in chip throughout the charging process to optimize battery life by actively controlling current, voltage and temperature.

The optimum charging system  
Forced air cooling

General charging method  
Natural heat dissipation



Fast charging

Waiting time for charging



The optimum charging system

General charging method

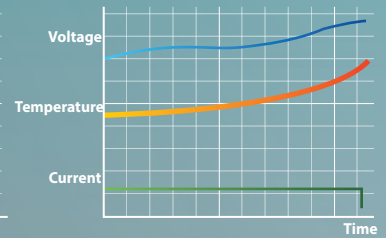
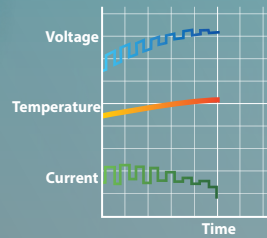

## Battery Protection Function

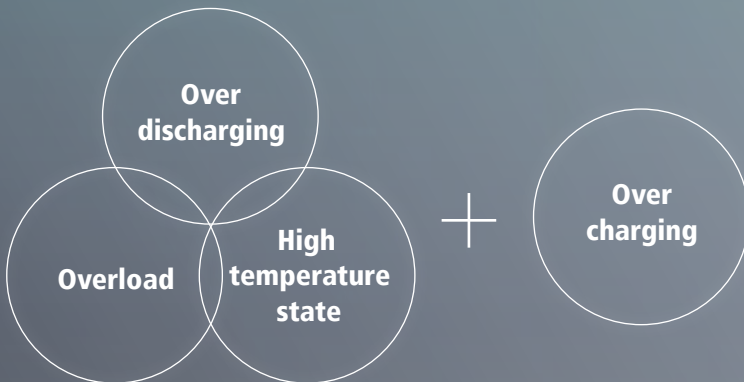

This function is communication technology that allows the tool and battery to monitor conditions and exchange data in real time to protect against Overload, Over-Discharge and Overheating.

**Anytime Charge**  
No Memory Effect  
No discharging required



**Shock Absorbing Heavy Duty Pack**

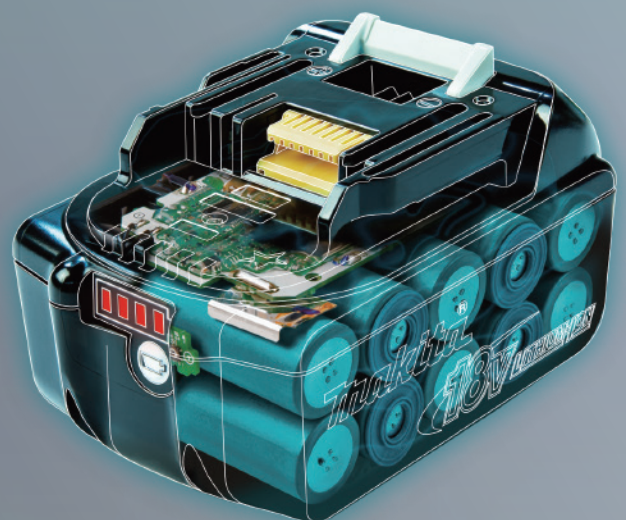





# 18V / 14.4V LXT

		LXT FAST CHARGER DC18RC	TWO PORT LXT FAST CHARGER DC18RD	LXT ECONOMY CHARGER DC18WC	MULTI PORT LXT + CXT FAST CHARGER DC18RE	FOUR PORT LXT CHARGER DC18SF	AUTOMOTIVE LXT CHARGER DC18SE		
110 - 120 ( 2PIN TYPE) PART NO		195582-6	196929-7*	630D28-4	198443-9			DRILLING / FIXING	
110 - 120 ( 3PIN TYPE) PART NO								CONCRETE DRILLING / DEMOLITION	
220 - 240 (2PIN TYPE) PART NO		195584-2	196933-6	630D32-3	198575-2			MIXING / STIRRING	
220 - 240 (3PIN TYPE) PART NO		197378-1	196940-9	630D34-9	198447-1	196427-1	194621-9 (compatible with 12V/24V DC cigarette lighter socket)	CUTTING (CONCRETE / METAL)	
Lithium-ion Battery									
18V LXT		14V LXT							
6.0Ah									
BATTERY ID	BL1860B								
PART NO	197422-4								
PACKAGE	Single								
FUEL GAUGE	✓								
		55 min.	55 min.	160 min.	55 min.	130 min. 1 to 2 batteries	130 min.		
						260 min. 3 to 4 batteries			
5.0Ah									
BATTERY ID	BL1850B								
PART NO	197280-8								
PACKAGE	Single								
FUEL GAUGE	✓								
		45 min.	45 min.	135 min.	45 min.	110 min. 1 to 2 batteries	110 min.	GRINDING	
						220 min. 3 to 4 batteries			
3.0Ah		3.0Ah							
BATTERY ID	BL1830B	BL1430B							
PART NO	197599-5	197615-3							
PACKAGE	Single	Single							
FUEL GAUGE	✓	✓							
		22 min.	22 min.	80 min.	22 min.	60 min. 1 to 2 batteries	60 min.	SANDING / POLISHING	
						120 min. 3 to 4 batteries			
1.5Ah		1.5Ah							
BATTERY ID	BL1815N	BL1415NA							
PART NO	632A54-1	196280-5							
PACKAGE	Bulk	Single							
FUEL GAUGE	x	✓							
		15 min.	15 min.	40 min.	15 min.	30 min. 1 to 2 batteries	30 min.	SAWING	
						60 min. 3 to 4 batteries			
1.3Ah									
BATTERY ID	BL1815								
PART NO	195445-6								
PACKAGE	Single								
FUEL GAUGE	x								
		15 min.	15 min.	40 min.	15 min.	30 min. 1 to 2 batteries	30 min.	ROUTERS / PLANERS	
						60 min. 3 to 4 batteries			

DC18SF: is not compatible with 14.4V Li-ion Battery  
196929-7\* - in future it will be available in 2 Pin only

# 12V MAX CXT

		SINGLE PORT CHARGER DC105B (CXT - FAST CHARGER)	TWO PORT CHARGER DC18RE (LXT + CXT FAST CHARGER)	
110 - 120 (2pin type) Part no		197435-5	198443-9	HEAT GUN / LASER
220 - 240 (2pin type) Part no		198576-0	198575-2	CLEANING
220 - 240 (3pin type) Part no		198433-2	198447-1	OPE
12V MAX / 10.8V CXT Lithium-ion				
4.0Ah				
BATTERY ID	BL1041B			
PART NO	197406-2			
PACKAGE	CARTON			
FUEL GAUGE	✓			
		60 min.	60 min.	JOB SITE TOOLS
2.0Ah				
BATTERY ID	BL1021B			
PART NO	197396-9			
PACKAGE	CARTON			
FUEL GAUGE	✓			
		30 min.	30 min.	SPECIALTY TOOLS
				CARRY CASE / TOOL HOLDERS / POUCHES

- DRILLING / FIXING
- CONCRETE DRILLING / DEMOLITION
- MIXING / STIRRING
- CUTTING (CONCRETE / METAL)
- GRINDING
- SANDING / POLISHING
- SAWING
- MULTI-TOOL
- ROUTERS / PLANERS
- NAILERS / STAPLERS
- HEAT GUN / LASER
- CLEANING
- OPE
- JOBSITE TOOLS
- SPECIALTY TOOLS
- CARRY CASE / TOOL HOLDERS / POUCHES

### 10.8V / 7.2V Li-ion battery / charger (Stick type)

		10.8V - 7.2V CHARGER DC10WA	7.2V CHARGER DC70SA
220 - 240 ( 2pin type) Part no		630584-0	194320-3 / 194588-1
220 - 240 ( 3pin type) Part no		630585-0	
<div style="display: flex; align-items: center;"> <div style="background-color: #004a7c; color: white; padding: 5px; margin-right: 10px;"> <b>10.8V</b> Lithium-ion (Stick battery)                 </div> <div style="border: 1px solid #ccc; padding: 5px;"> <b>1.3Ah</b> </div> <div style="margin-left: 10px;"> </div> </div>		 <b>50</b> min.	 -
<div style="display: flex; align-items: center;"> <div style="background-color: #004a7c; color: white; padding: 5px; margin-right: 10px;"> <b>7.2V</b> Lithium-ion (Stick battery)                 </div> <div style="border: 1px solid #ccc; padding: 5px;"> <b>1.0Ah</b> </div> <div style="margin-left: 10px;"> </div> </div>		<b>30</b> min.	<b>30</b> min.

### In Build Battery and Adapter

3.6V Li-ion (In-built Battery) For model: DF001DW	12VMAX Li-ion (In-built Battery BL1020V) For model: CL117FD	10.8V Li-ion (In-built Battery) For model: CL105DWX
<b>1.5Ah</b> Part no: 620693-3	<b>2.0Ah</b> Part no: 632R12-9	<b>1.3Ah</b> Part no: 632D82-4
<b>AC ADAPTER ADP07</b> (2 PIN) 198363-7 (3 PIN) 198369-5	<b>AC ADAPTER DC1002</b> (2 PIN) 191L80-0 (3 PIN) 191L84-2	<b>AC ADAPTER DC1001</b> 196990-4
<b>3-5</b> hrs.	<b>2</b> hrs.	<b>2</b> hrs.

### 36V Li-ion

		DC36RA	DC3600
110 - 120 ( 2pin type) Part no			197727-2
220 - 240 ( 3pin type) Part no		194864-3	-
<div style="display: flex; align-items: center;"> <div style="background-color: #004a7c; color: white; padding: 5px; margin-right: 10px;"> <b>36V</b> LXT Lithium-ion                 </div> <div style="border: 1px solid #ccc; padding: 5px;"> <b>2.6Ah</b> </div> <div style="margin-left: 10px;"> </div> </div>		 <b>22</b> min.	 -
<div style="display: flex; align-items: center;"> <div style="background-color: #004a7c; color: white; padding: 5px; margin-right: 10px;"> <b>12.0Ah</b> </div> <div style="border: 1px solid #ccc; padding: 5px;"> <b>12.0Ah</b> </div> <div style="margin-left: 10px;"> </div> </div>		-	<b>180</b> min.

## 18V Ni-Mh Battery



Battery ID	Battery Ah	Type	Voltage	Partno
1835	2.8 Ah	Cluster	18 V	193061-8
1435	2.8 Ah	Cluster	14.4 V	193060-0
9135	2.8 Ah	Cluster	9.6 V	193058-7
1235	3.0 Ah	Cluster	12 V	193059-5
7034	2.5 Ah	Stick	7.2 V	193888-6

## DC1804

- Charger for Ni-Cd batteries.
- 30 and 45 charger for a wide variety of Makita NI-CD Batteries



Battery Type	Battery Range	Voltage	Plug Pin Type	Part no
Ni-Cd	7.2V - 18V	127	-	193848-8
		220 - 240	2	193827-6
		220 - 240	3	197380-4

## DC1414

- Charger for Ni-Cd batteries.
- 30 and 45 minutes charge for a wide variety of Makita Batteries



Battery Type	Battery Range	Voltage	Plug Pin Type	Part no
Ni-Cd	7.2V - 18V	220 - 240	2	193864-0

## Wireless unit (Bluetooth chip)

- for AWS machines
- Bluetooth



ID	Part no
WUT01	198900-7

## Battery Adapters

Enables to separate the battery from the tool to reduce the tool weight for less hand and arm fatigue.

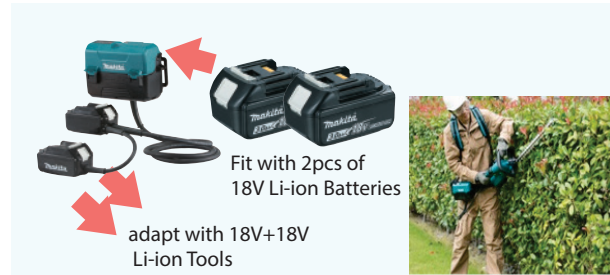

Type	For Model	Part no
BAP182	18V + 18V Li-Ion	197581-4



For Model	Part no
18V+18V Li-Ion	197727-2

### BAP18C

**Specially designed for use with 18V LXT cordless cleaners**

Transfers the battery weight from the cleaner to user's waist to reduce the stress on hand



Type	For Model	Part no
BAP18C	18V LXT (Stick Cleaners)	191M50-5

## Battery Protector

Designed to protect the battery cartridge from dust and dripping water in outdoor applications or harsh environments



For Battery	Part No.
BL1415, BL1430, BL1440	195797-5
BL1830B, BL1850B, BL1860B	195798-3

Flexible battery protector  
Prevents damage to the battery and work material



For Battery	Part No.
BL1830B, BL1850B, BL1860B	422807-8

DRILLING / FIXING

CONCRETE DRILLING / DEMOLITION

MIXING / STIRRING

CUTTING (CONCRETE / METAL)

GRINDING

SANDING / POLISHING

SAWING

MULTI-TOOL

ROUTERS / PLANERS

NAILERS / STAPLERS

HEAT GUN / LASER

CLEANING

OPE

JOB SITE TOOLS

SPECIALTY TOOLS

CARRY CASE / TOOL HOLDERS / POUCHES

DRILLING / FIXING

## Power Source Kit

A combination of Makita 18V Li-ion Batteries and Charger in a Makpac connector case with moulded inlay. Makita owns the world's largest cordless tool line-up in 18V Li-ion tools and offer them in different variants i.e. 6.0Ah, 5.0Ah, 3.0Ah. Tools are also offered without battery & charger. Now pick up the Makita Power source kit, then purchase the 18V "bare tools" and you get the job done. It's an ideal way to start building a Makita cordless tool line-up. Users who preowned "Tool only version" (i.e. Tool without battery and charger) can benefit with this power source kits.

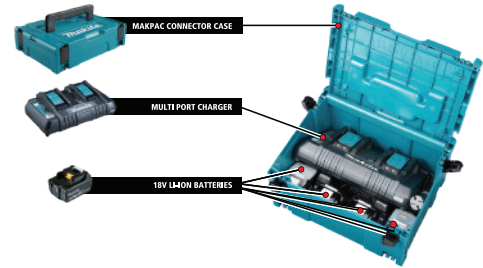

CONCRETE DRILLING / DEMOLITION

MIXING / STIRRING

CUTTING (CONCRETE / METAL)

### XGT-PSK 8.0Ah

Part no	BATTERY				CHARGER					MAKPAC CASE
	MODEL	VOLTS	AMPERE	QTY	MODEL	VOLTS	PORT	PIN	QTY	
1910A4-1 ■	BL4080F	40V MAX	8.0Ah	2pcs	DC40RB	40V MAX	2	3	1pc	Type 3

GRINDING

### XGT-PSK 5.0Ah

Part no	BATTERY				CHARGER					MAKPAC CASE
	MODEL	VOLTS	AMPERE	QTY	MODEL	VOLTS	PORT	PIN	QTY	
191V43-6 ■	BL4050F	40V MAX	5.0Ah	2pcs	DC40RA	40V MAX	1	3	1pc	Type 3
191U21-0	BL4050F	40V MAX	5.0Ah	2pcs	DC40RB	40V MAX	2	3	1pc	Type 3
191U22-8	BL4050F	40V MAX	5.0Ah	2pcs	DC40RB	40V MAX	2	2	1pc	Type 3

SANDING / POLISHING

SAWING

### XGT-PSK 4.0Ah

Part no	BATTERY				CHARGER					MAKPAC CASE
	MODEL	VOLTS	AMPERE	QTY	MODEL	VOLTS	PORT	PIN	QTY	
191K03-2	BL4040	40 MAX	4.0Ah	2pcs	DC40RA	40V MAX	1	3	1pc	Type 1

MULTI-TOOL

ROUTERS / PLANERS

### LXT-PSK 6.0Ah

Part no	BATTERY				CHARGER					MAKPAC CASE
	MODEL	VOLTS	AMPERE	QTY	MODEL	VOLTS	PORT	PIN	QTY	
198082-5	BL1860B	18V Li-ion	6.0Ah	2pcs	DC18RD	14.4V - 18V Li-ion	2	3	1pc	Type 3
198108-3	BL1860B	18V Li-ion	6.0Ah	1pc	DC18RC	14.4V - 18V Li-ion	1	3	1pc	Type 1

NAILERS / STAPLERS

### LXT-PSK 5.0Ah

Part no	BATTERY				CHARGER					MAKPAC CASE
	MODEL	VOLTS	AMPERE	QTY	MODEL	VOLTS	PORT	PIN	QTY	
198568-9	BL1850B	18V Li-ion	5.0Ah	4pcs	DC18RD	14.4V - 18V Li-ion	2	3	1pc	Type 3
199592-5	BL1850B	18V Li-ion	5.0Ah	4pcs	DC18RD	14.4V - 18V Li-ion	2	2	1pc	Type 3
198567-1	BL1850B	18V Li-ion	5.0Ah	2pcs	DC18RD	14.4V - 18V Li-ion	2	3	1pc	Type 3

HEAT GUN / LASER

CLEANING

### LXT-PSK 3.0Ah

Part no	BATTERY				CHARGER					MAKPAC CASE
	MODEL	VOLTS	AMPERE	QTY	MODEL	VOLTS	PORT	PIN	QTY	
197972-9	BL1830B	18V Li-ion	3.0Ah	4pcs	DC18RD	14.4V - 18V Li-ion	2	3	1pc	Type 2
191A26-0	BL1830B	18V Li-ion	3.0Ah	1pc	DC18RC	14.4V - 18V Li-ion	1	3	1pc	Carton Box

OPE

JOBSITE TOOLS

### LXT/CXT (With 4.0Ah CXT Battery x 1pc and 5.0Ah LXT Battery x 1pc)

Part no	BATTERY				CHARGER					MAKPAC CASE
	MODEL	VOLTS	AMPERE	QTY	MODEL	VOLTS	PORT	PIN	QTY	
199360-6	BL1041B	12V MAX Li-ion	4.0Ah	1pc	DC18RE	12V MAX CXT & 18V LXT	MULTI	3	1pc	Type 3
	BL1850B	18V Li-ion	5.0Ah	1pc						
199359-1	BL1041B	12V MAX Li-ion	4.0Ah	1pc	DC18RE	12V MAX CXT & 18V LXT	MULTI	2	1pc	Type 3
	BL1850B	18V Li-ion	5.0Ah	1pc						

SPECIALTY TOOLS

CARRY CASE / TOOL HOLDERS / POUCHES

## Portable Power Source Units

### PDC1500



**Backpack utilizes Built-in battery cells to provide 43.55Ah and longer run time**

Provides up to 1.3 times more runtime than PDC1200.

Provides up to 5.4 times more runtime than 8.0Ah XGT battery

#### Compatible across three platforms

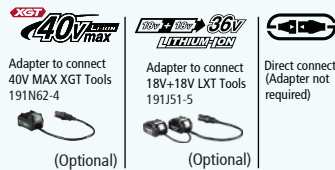

#### Specification

<b>Voltage Output</b>	36V
<b>Energy capacity</b>	1500 Wh
<b>Capacity</b>	43.55 Ah
<b>Charging Hours</b>	8hrs with DC4001
<b>Length of cable</b>	1.1m (Cable to tool)
<b>Dimensions (LxWxH)</b>	369x312x130 mm
<b>Net weight</b>	13.0 kg

#### Available Variants

TYPE	VARIANTS	CHARGER
BUILT-IN BATTERY CELLS	PDC1500A01	DC4001 (191L08-8)

Note:- PDC1500 and PDC1200 cannot connected to 18V single battery LXT machines

### PDC1200



**Backpack utilizes Built-in battery cells to provide 33.5Ah and longer run time**

Provides up to 5.6 times more runtime that 18Vx2 tools used with 2x 6.0Ah batteries



#### Compatible across three platforms



#### Specification

<b>Voltage Output</b>	36V
<b>Energy capacity</b>	1200 Wh
<b>Capacity</b>	33.5 Ah
<b>Charging Hours</b>	6hrs with DC4001
<b>Length of cable</b>	1.1m (Cable to tool)
<b>Dimensions (LxWxH)</b>	369x261x139
<b>Net weight</b>	10.4 kg

#### Available Variants

TYPE	VARIANTS	CHARGER
BUILT-IN BATTERY CELLS	PDC1200A02	DC4001 (191L08-8)

### PDC01



**Backpack utilizes upto four 18V LXT batteries to provide longer run time**

- 2 times the runtime with 18Vx2 tools

- 4 times the runtime with 18V tools

(Note:- Batteries sold seperately)

#### Compatible across four platforms



#### Specification

<b>Voltage</b>	18V / 36V
<b>Energy capacity</b>	432 Wh (with 4 LXT battery)
<b>Capacity</b>	24 / 12 Ah (with 4 LXT battery)
<b>Charging Hours</b>	-
<b>Length of cable</b>	1.1m (Cable to tool)
<b>Dimensions (LxWxH)</b>	400x195x132mm
<b>Net weight</b>	7.0 kg (with 4 LXT battery)

#### Available Variants

TYPE	VARIANTS	ADPATER
W/O BATTERY/CHARGER	PDC01 (191A67-6)	18V + 18V LXT Adapter

## BAC01 - Power Converter powered by Makita portable power pack

#### Turns DC power into AC power

Adapt portable power pack units to supply AC power to corded tools and also works as emergency power source for home appliances when AC power is not accessible

- Multiple outputs including: 2 AC outlets, 2 Type-A USB output ports, 2 Type-C USB output ports, 1 DC12V cigar socket
- 7-stage output indication by 7 LED lamps allow users to understand compatible appliances.
- Can be connected firmly with MAKPAC system
- Double insulated

#### Compatible products:-

Charges LXT and XGT batteries via respective fast chargers  
Works as power source for home appliances such as 4K LCD TV, Compact refrigerator, LED worklight, Fan, Rice cooker, Electric kettle, Electric thermo pot, Household microwave (500W) and many more



#### Specification

<b>AC output voltage</b>	230V (50/60 Hz)
<b>Input power source</b>	PDC1500 / PDC1200 / PDC01
<b>Continuous rating output</b>	1,400W (PDC1200) / 750W (PDC01)
<b>Max output</b>	2800W
<b>Continuous run time</b>	56 mins. with PDC1200* 20 mins. with PDC01**
<b>Dimensions (LxWxH)</b>	395 x 345 x 163mm
<b>Net weight</b>	7.3 Kg (Body only)

(Note: The Portable Power Source Unit is not included with BAC01)

\*PDC1200: @ discharging at a rate of 1,000W(VA)

\*\*PDC01: With four BL1860B batteries @ discharging at a rate of 750W(VA)

DRILLING / FIXING

CONCRETE DRILLING / DEMOLITION

MIXING / STIRRING

CUTTING (CONCRETE / METAL)

GRINDING

SANDING / POLISHING

SAWING

MULTI-TOOL

ROUTERS / PLANERS

NAILERS / STAPLERS

HEAT GUN / LASER

CLEANING

OPE

JOB SITE TOOLS

SPECIALTY TOOLS

CARRY CASE / TOOL HOLDERS / POUCHES

# Drilling / Fixing

Driver Drill, Percussion Drill, Drill, Impact Drill, Impact Driver, Impact Wrench





**DF001G 13mm** 40V MAX | **XGT**

**Cordless Driver Drill**

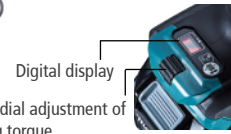

Digital display  
Easy jog dial adjustment of fastening torque

**Efficient, Durable, Compact, Lightweight Outstanding Performance. Excellent in Continuous Heavy-Duty Work**

- Delivers 140Nm of Max torque achieved with combination of high power brushless motor and innovative XGT battery
- Delivers 35% or more higher speed than LXT model DDF481

**New electronic clutch settings**

- A higher range of torque can be covered than with mechanical clutch
- 41-stage setting in gear one • 21-stage setting in gear two



<b>Capacity</b>	Steel: 20 mm Wood: 50 mm (Auger-Bit), Wood: 76 mm (Self-Feed Bit), Wood: 152 mm (Hole Saw)
<b>Chuck Capacity</b>	1.5 - 13 mm
<b>No Load Speed (RPM)</b>	High / Low: 0 - 2,600 / 0 - 650
<b>Max Fastening Torque</b>	Hard / Soft: 140 / 68 N.m
<b>Dimensions (L x W x H)</b>	181 x 86 x 282 mm
<b>Net weight</b>	2.0 kg (without Battery)

**Standard Equipment:** Side Grip.

**AVAILABLE VARIANTS**

4.0Ah	"Z" VARIANT
<b>DF001G M2</b> INCLUDES 2 BATTERIES / 1 CHARGER / MAKPAC CONNECTOR CASE	<b>DF001G Z</b> TOOL ONLY (DOES NOT INCLUDE BATTERY / CHARGER / CARRYING CASE)

- DRILLING / FIXING
- CONCRETE DRILLING / DEMOLITION
- MIXING / STIRRING
- CUTTING (CONCRETE / METAL)
- GRINDING
- SANDING / POLISHING
- SAWING
- MULTI-TOOL
- ROUTERS / PLANERS

**DF002G 13mm** 40V MAX | **XGT**

**Cordless Driver Drill**



**Efficient, Durable, Compact, Lightweight Outstanding Performance.**

- Delivers 64Nm of Max torque achieved with combination of brushless motor and innovative XGT battery
- 21 adjustable mechanical clutch settings



<b>Capacity</b>	Steel: 13 Wood: 38 (Auger Bit, Self-Feed Bit) Wood (Hole Saw): 51mm
<b>Chuck Capacity</b>	1.5 - 13 mm
<b>No Load Speed (RPM)</b>	High / Low: 0 - 2,200 / 0 - 600
<b>Max Fastening Torque</b>	Hard / Soft: 64 / 30 N.m
<b>Dimensions (L x W x H)</b>	164 x 86 x 215 mm (without Battery)
<b>Net weight</b>	1.2kg (without Battery)

**Standard Equipment:** Side Grip.

**AVAILABLE VARIANTS**

2.0Ah	"Z" VARIANT
<b>DF002G A2</b> INCLUDES 2 BATTERIES / 1 CHARGER / MAKPAC CONNECTOR CASE	<b>DF002G Z</b> TOOL ONLY (DOES NOT INCLUDE BATTERY/ CHARGER / CARRYING CASE)

**DDF486 - 13mm** 18V | **LXT**

**Cordless Driver Drill**



**Increased performance in continuous heavy-duty applications**

- Increased max clutch torque enables to adjust clutch torque even when tightening fasteners into hard material
- Durable aluminium gear housing
- Mechanical 2 speed gearing with all metal gear construction
- XPT technology that protects against dust & moisture
- Compact and ergonomic design at only 178 mm long
- 21 torque settings



<b>Capacity</b>	Steel: 13 mm Wood (Auger-Bit): 50 mm   Wood (Self-Feed Bit): 76 mm Siding Board: 170 mm
<b>Chuck Capacity</b>	1.5 - 13 mm (1/16 - 1/2")
<b>No Load Speed (RPM)</b>	High / Low: 0 - 2,100 / 0 - 550
<b>Max Fastening Torque</b>	Hard / Soft: 130 / 65 N.m
<b>Dimensions (L x W x H)</b>	178 x 81 x 265 mm
<b>Net weight</b>	2.6 kg

**Standard Equipment:** (+)(-) bit, Belt clip

**AVAILABLE VARIANTS**

5.0Ah	3.0Ah	"Z" VARIANT
<b>DDF486 RTJ</b> INCLUDES 2 BATTERIES / 1 CHARGER / MAKPAC CONNECTOR CASE	<b>DDF486 RFJ</b> INCLUDES 2 BATTERIES / 1 CHARGER / MAKPAC CONNECTOR CASE	<b>DDF486 Z</b> TOOL ONLY (DOES NOT INCLUDE BATTERY / CHARGER / CARRYING CASE)

- NAILERS / STAPLERS
- HEAT GUN / LASER
- CLEANING
- OPE
- JOB SITE TOOLS
- SPECIALTY TOOLS
- HAND TOOLS / COMBINATION SET
- TOOL HOLDERS AND POUCHES / MAKPAC SYSTEM

DRILLING /  
FIXING

CONCRETE  
DRILLING /  
DEMOLITION

MIXING /  
STIRRING

CUTTING  
(CONCRETE /  
METAL)

GRINDING

SANDING /  
POLISHING

SAWING

MULTI-TOOL

ROUTERS /  
PLANERS

NAILERS /  
STAPLERS

HEAT GUN /  
LASER

CLEANING

OPE

JOBSITE  
TOOLS

SPECIALTY  
TOOLS

HAND TOOLS /  
COMBINATION SET

TOOL HOLDERS  
AND POUCHES /  
MAKPAC SYSTEM

**DDF481 13mm** 18V | **LXT**

**Cordless Driver Drill**



**Large brushless motor provides higher power and productivity**

- Durable aluminium gear housing
- Mechanical 2 speed gearing with all metal gear construction
- XPT technology that protects against dust & moisture
- 21 torque settings



<b>Capacity</b>	Steel : 13mm Wood : 76mm
<b>No load speed (rpm)</b>	Hi : 0-2,100 Lo : 0-550
<b>Max fastening torque</b>	Hard / Soft : 115 / 60N m
<b>Dimensions (L x W x H)</b>	205x79x249mm
<b>Net weight</b>	2,7kg

**Standard Equipment:** (+)(-) bit, Side grip

**AVAILABLE VARIANTS**

<b>5.0Ah</b>	<b>"Z" VARIANT</b>
<b>DDF481 RTJ</b> INCLUDES 2 BATTERIES / 1 CHARGER / MAKPAC CONNECTOR CASE	<b>DDF481 Z</b> TOOL ONLY (DOES NOT INCLUDE BATTERY / CHARGER / CARRYING CASE)

**DDF489 13mm** 18V | **LXT**

**Cordless Driver Drill**



**Large brushless motor provides higher power and productivity**

- Durable aluminium gear housing
- Mechanical 2 speed gearing with all metal gear construction
- XPT technology that protects against dust & moisture
- 21 torque settings



<b>Capacity</b>	Steel: 13 mm Wood (Auger-Bit): 38 mm Wood (Self-feed bit & Hole Saw) : 51 mm
<b>Chuck capacity</b>	1.5 - 13 mm
<b>No Load Speed (RPM)</b>	High / Low: 0 - 1,800 / Low: 0 - 550
<b>Max Fastening Torque</b>	Hard / Soft: 70 / 36 N m
<b>Dimensions (L x W x H)</b>	172x81x261 mm
<b>Net weight</b>	1.8 kg

**Standard Equipment:** (+)(-) bit, Belt clip

**AVAILABLE VARIANTS**

<b>5.0Ah</b>	<b>"Z" VARIANT</b>
<b>DDF489 RTJ</b> INCLUDES 2 BATTERIES / 1 CHARGER / MAKPAC CONNECTOR CASE	<b>DDF489 Z</b> TOOL ONLY (DOES NOT INCLUDE BATTERY / CHARGER / CARRYING CASE)

**DDF484 13mm** 18V | **LXT**

**Cordless Driver Drill**



**Powerful Brushless motor & Compact and ergonomic design**

- Delivers more drilling, driving and fastening speed
- Aluminum gear housing creates an impression of rigidity and luxuriousness
- Variable 2-speed for a wide range of drilling and fastening applications
- Built-in twin LED lights with pre-glow and afterglow functions illuminate the work area



<b>Capacity</b>	Steel / Wood: 13 / 38 mm Wood (Self-feed bit): 76 mm
<b>Chuck capacity</b>	1.5 - 13 mm
<b>No Load Speed (RPM)</b>	High / Low: 0 - 2,000 / 0 - 500
<b>Max Fastening Torque</b>	Hard / Soft: 54 / 30 N m
<b>Dimensions (L x W x H)</b>	172x79x261 mm
<b>Net weight</b>	1.8 kg

**Standard Equipment:** (+)(-) bit, Belt clip

**AVAILABLE VARIANTS**

<b>5.0Ah</b>	<b>"Z" VARIANT</b>
<b>DDF484 RTJ</b> INCLUDES 2 BATTERIES / 1 CHARGER / MAKPAC CONNECTOR CASE	<b>DDF484 Z</b> TOOL ONLY (DOES NOT INCLUDE BATTERY / CHARGER / CARRYING CASE)

**DDF453 13mm** 18V | **LXT**

**Cordless Driver Drill**



**All metal gear construction ensures high transmission durability**

- Single sleeve keyless chuck enables easy bit installation/removal with one hand.
- Ergonomically designed rubberized soft grip provides more control and comfort.



<b>Capacity</b>	Steel: 13 mm / Wood: 36 mm Wood (Self-feed bit): 76 mm
<b>No load speed (rpm)</b>	High: 0-1,300 / Low: 0-400
<b>Max. fastening torque</b>	Hard / Soft: 42 / 27 N m
<b>Dimensions (L x W x H)</b>	222x79x244 mm
<b>Net weight</b>	2 kg

**Standard Equipment:** (+)(-) bit, Belt clip

**AVAILABLE VARIANTS**

<b>3.0Ah</b>	
<b>DDF453 RFE</b> INCLUDES 2 BATTERIES / 1 CHARGER / PLASTIC CARRYING CASE	



**DDF487** 13mm 18V | **LXT**

**Cordless Driver Drill**



**Ultra compact design and lightweight**

- Mechanical 2 speed gearing
- 1,700rpm no load speed motor delivers fast driving performance
- XPT technology that protects against dust & moisture
- Twin LED Job light with after-glow function



<b>Capacity</b>	Steel / Wood (Auger Bit) / Wood (Self-Feed Bit) / Wood (Hole Saw): 13 / 36 / 35 / 51 mm
<b>Chuck Capacity</b>	1.5 - 13 mm (1/16 - 1/2")
<b>No Load Speed (RPM)</b>	High / Low: 0 - 1,700 / 0 - 500
<b>Max Fastening Torque</b>	Hard / Soft: 40 / 25 N-m
<b>Dimensions (L x W x H)</b>	150 x 81 x 248 mm
<b>Net weight</b>	1.6 kg

**Standard Equipment:** (+)(-) bit, Belt clip

AVAILABLE VARIANTS			
5.0Ah	3.0Ah	3.0Ah	"Z" VARIANT
<b>DDF487 RTJ</b> INCLUDES 2 BATTERIES / 1 CHARGER / MAKPAC CONNECTOR CASE	<b>DDF487 RFJ</b> INCLUDES 2 BATTERIES / 1 CHARGER / MAKPAC CONNECTOR CASE	<b>DDF487 RF1</b> INCLUDES 1 BATTERY / 1 CHARGER / MAKPAC CONNECTOR CASE	<b>DDF487 Z</b> TOOL ONLY (DOES NOT INCLUDE BATTERY / CHARGER / CARRYING CASE)

**DF332D** - 10mm 12V MAX | **CXT**

**Cordless Driver Drill**



**More compact and more work amount thanks to the newly developed brushless motor**

- High rotational speed
- Best possible ergonomic handle for drilling/driving applications
- Battery protection circuit is activated on high battery temperature to protect the battery from damages due to overdischarge, high temperature or overload current.
- 10mm (3/8") single sleeve keyless drill chuck with click sound to indicate that drill bit is fully locked



<b>Capacity</b>	Steel : 10mm (3/8") Wood : 28mm (1-1/8")
<b>No load speed (rpm)</b>	Hi : 0-1,500 / Lo : 0-450
<b>Max tightening torque</b>	Hard / Soft : 35 / 21N m
<b>Dimensions (L x W x H)</b>	154x66x217mm (6-1/6"x2-5/8"x8-1/2")
<b>Net weight</b>	1.0kg (2.3lbs)

**Standard Equipment:** Belt clip, Phillips bit

AVAILABLE VARIANTS	
2.0Ah	"Z" Version
<b>DF332D WAE</b> INCLUDES 2 BATTERIES / 1 CHARGER / CARRYING CASE	<b>DF332D Z</b> TOOL ONLY (DOES NOT INCLUDE BATTERY / CHARGER OR CARRY CASE)

**DDF483** 13mm 18V | **LXT**

**Cordless Driver Drill**



**New Ultra-compact and ergonomic design at only 162mm long and lightweight for reduced operator fatigue**

- Brushless motor provides higher power and productivity
- Variable 2-speed for a wide range of drilling and fastening applications





<b>Capacity</b>	Steel / Wood: 13 / 36 mm
<b>Chuck capacity</b>	1.5 - 13 mm
<b>No Load Speed (RPM)</b>	High / Low: 0 - 1,700 / 0 - 500
<b>Max Fastening Torque</b>	Hard / Soft: 40 / 23 N m
<b>Dimensions (L x W x H)</b>	162x79x247 mm
<b>Net weight</b>	1.6 kg

**Standard Equipment:** (+)(-) bit, Belt clip

AVAILABLE VARIANTS		
5.0Ah	3.0Ah	"Z" VARIANT
<b>DDF483 RTJ</b> INCLUDES 2 BATTERIES / 1 CHARGER / MAKPAC CONNECTOR CASE	<b>DDF483 RFJ</b> INCLUDES 2 BATTERIES / 1 CHARGER / MAKPAC CONNECTOR CASE	<b>DDF483 Z</b> TOOL ONLY (DOES NOT INCLUDE BATTERY / CHARGER / CARRYING CASE)

**DF333D** - 10mm 12V MAX | **CXT**

**Cordless Driver Drill**

**Compact and ergonomic design with only 179mm length**

- Ball bearing reduces chuck wobbling
- Slide style battery and improved ergonomic grip
- Variable 2-speed (0-450 & 0-1,700 RPM) for a wide range of drilling and fastening applications
- Increased motor power for higher application speed and max tightening torque



<b>Capacity</b>	Steel / Wood: 10 / 21 mm
<b>Chuck capacity</b>	DF333D: 0.8 - 10 mm
<b>No Load Speed (RPM)</b>	High / Low: 0 - 1,700 / 0 - 450
<b>Max Fastening Torque</b>	Hard / Soft: 30 / 14 N m
<b>Max lock torque</b>	28 N m
<b>Dimensions (L x W x H)</b>	179x66x212 mm
<b>Net weight</b>	1.2 kg

**Standard Equipment:** Belt clip

AVAILABLE VARIANTS	
2.0Ah	"Z" Version
<b>DF333D WAE</b> INCLUDES 2 BATTERIES / 1 CHARGER / CARRYING CASE	<b>DF333D Z</b> TOOL ONLY (DOES NOT INCLUDE BATTERY / CHARGER OR CARRY CASE)

- DRILLING / FIXING
- CONCRETE DRILLING / DEMOLITION
- MIXING / STIRRING
- CUTTING (CONCRETE / METAL)
- GRINDING
- SANDING / POLISHING
- SAWING
- MULTI-TOOL
- ROUTERS / PLANERS
- NAILERS / STAPLERS
- HEAT GUN / LASER
- CLEANING
- OPE
- JOBSITE TOOLS
- SPECIALTY TOOLS
- HAND TOOLS / COMBINATION SET
- TOOL HOLDERS AND POUCHES / MAKPAC SYSTEM

DRILLING / FIXING
CONCRETE DRILLING / DEMOLITION
MIXING / STIRRING
CUTTING (CONCRETE / METAL)
GRINDING
SANDING / POLISHING
SAWING
MULTI-TOOL
ROUTERS / PLANERS
NAILERS / STAPLERS
HEAT GUN / LASER
CLEANING
OPE
JOBSITE TOOLS
SPECIALTY TOOLS
HAND TOOLS / COMBINATION SET
TOOL HOLDERS AND POUCHES / MAKPAC SYSTEM

### DF012D - 5mm 7.2V

**Cordless Driver Drill**



**Ultra-lightweight and compact tool**

- Auto-stop clutch: tool shuts off when clutch disengages for extra fastening control; prevents overdriving the fastener
- 2-Speed design for high or low torque applications
- Comfortable grip design operates in straight or pistol grip positions
- Can be also used as a hand driver
- 21 Clutch settings and drill mode for added fastening control
- Lock lever prevents accidental startup



Capacity	Steel: 5 mm / Wood: 6 mm
No Load Speed (RPM)	High: 650 / Low: 200
Max Fastening Torque	Hard / Soft: 5.6 / 3.6 N m
Dimensions (L x W x H)	Pistol Style: 218x44x142 mm
Dimensions (L x W)	Straight Style: 273x44 mm
Net weight	0.53 kg

**Standard Equipment:** Phillips Bit

**AVAILABLE VARIANTS**

**1.5Ah**

**DF012DSJ**  
INCLUDES 2 BATTERIES / 1 CHARGER / CARRYING CASE

### DF0300 10mm

**Driver Drill**





**Excellent usability and compact**

- Compact and lightweight design.
- 2 sleeve keyless Drill chuck allows for easy bit installation/ removal by one hand
- Mechanical 2-speed gearing
- 20 Torque settings
- Ergonomic handle with soft grip for driver-drill applications
- Variable speed control by trigger

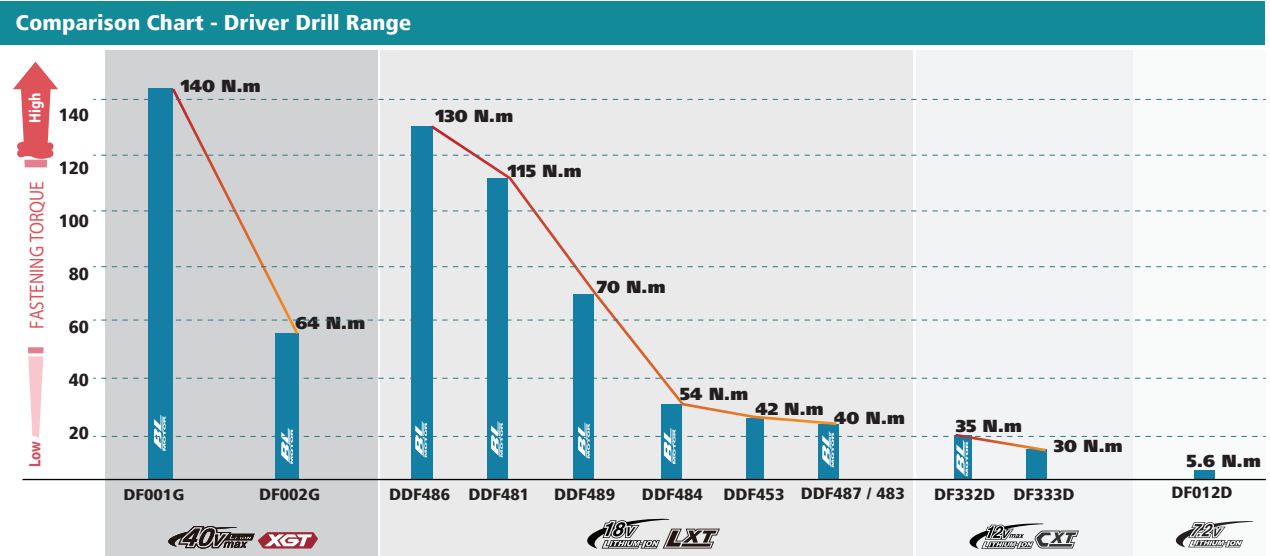

Continuous rating input	320W
Capacity	Steel / Wood: 10 / 28mm
Chuck Capacity	1.0 - 10 mm
No Load Speed (RPM)	High / Low: 0 - 1,500 / 0 - 450
Max Fastening Torque	Hard / Soft: 56.0 / 21.0 N m
Max lock torque	42.0 N m (370 in.lbs.)
Vibration Level	2.5 m/s <sup>2</sup> or less
Sound Pressure Level	80 dB(A)
Sound Power Level	91 dB(A)
Dimensions (L x W x H)	220x67x206 mm
Net weight	1.2 kg
Power supply cord	2.5 m



Model No.	Voltage	No load speed (rpm)	Mechanical Speed	Torque Setting	Max. fastening torque Hard / Soft (N-m)	Overall length (mm)	Net weight (kg)	BL motor
DF001G	40V MAX XGT	0-2,600 / 650	2-Speed	21 / 41	140 / 68	181	2.0 kg	●
DF002G		0-2,200 / 600	2-Speed	21	64 / 30	164	1.2 kg	●
DDF486	18V LXT	0-2,100 / 550	2-Speed	21	130 / 65	178	2.6 kg	●
DDF481		0-2,100 / 550	2-Speed	21	115 / 60	205	2.7 kg	●
DDF489		0 - 1,800 / 550	2-Speed	21	70 / 36	174	1.8 kg	●
DDF484		0-2,000 / 500	2-Speed	21	54 / 30	172	1.8 kg	●
DDF453		0-1,300 / 0-400	2-Speed	16	42 / 27	223	2.0 kg	-
DDF487		0-1,700 / 500	2-Speed	20	40 / 25	150	1.6 kg	●
DDF483		0-1,700 / 500	2-Speed	20	40 / 23	162	1.6 kg	●
DF332D	12V CXT	0-1,500 / 450	2-Speed	20	35 / 21	154	1.0 kg	●
DF333D		0-1,700 / 450	2-Speed	20	30 / 14	179	1.2 kg	-
DF012D	7.2V	650 / 200	2-Speed	21	5.6 / 3.6	218	0.53 kg	-
DF0300	320W	0-1,500 / 0- 450	2-Speed	20	56 / 21	220	1.2 kg	-

**HP001G** 13mm 40V MAX | **XGT**

**Cordless Percussion Driver Drill**





Digital display  
Easy jog dial adjustment of fastening torque

**Efficient, Durable, Compact, Lightweight Outstanding Performance. Excellent in Continuous Heavy-Duty Work**

- Delivers 140Nm of Max torque achieved with combination of high power brushless motor and innovative XGT battery
- Delivers 35% or more higher speed than LXT model DDF481

**New electronic clutch settings**  
A higher range of torque can be covered than with mechanical clutch

- 41-stage setting in gear one • 21-stage setting in gear two



<b>Capacity</b>	Masonry: 20mm   Steel: 20mm Wood: 50mm (Auger-Bit), Wood: 76mm (Self-Feed Bit), Wood: 152mm (Hole Saw)
<b>Chuck Capacity</b>	1.5 - 13 mm
<b>Impacts Per Minute (IPM)</b>	High / Low: 0 - 39,000 / 0 - 9,750
<b>No Load Speed (RPM)</b>	High / Low: 0 - 2,600 / 0 - 650
<b>Max Fastening Torque</b>	Hard / Soft: 140 / 68 N.m
<b>Dimensions (L x W x H)</b>	182x86x282 mm
<b>Net weight</b>	2.0 kg (without Battery)

**Standard Equipment:** Side Grip.

AVAILABLE VARIANTS	
4.0Ah	"Z" VARIANT
<b>HP001G M2</b> INCLUDES 2 BATTERIES / 1 CHARGER / MAKPAC CONNECTOR CASE	<b>HP001G Z</b> TOOL ONLY (DOES NOT INCLUDE BATTERY / CHARGER / CARRYING CASE)

**HP002G** 13mm 40V MAX | **XGT**

**Cordless Percussion Driver Drill**



**Efficient, Durable, Compact, Lightweight Outstanding Performance.**

- Delivers 64Nm of Max torque achieved with combination of brushless motor and innovative XGT battery
- 21 adjustable mechanical clutch settings





<b>Capacity</b>	Masonry: 13mm   Steel 13mm Wood: 38mm (Auger Bit, Self-Feed Bit)   Wood (Hole Saw): 51mm
<b>Chuck Capacity</b>	1.5 - 13 mm
<b>Impacts Per Minute (IPM)</b>	High / Low: 0 - 33,000 / 0 - 9,000
<b>No Load Speed (RPM)</b>	High / Low: 0 - 2,200 / 0 - 600
<b>Max Fastening Torque</b>	Hard / Soft: 64 / 30 Nm
<b>Dimensions (L x W x H)</b>	174 x 86 x 215 mm (without Battery)
<b>Net weight</b>	1.3kg (without Battery)

**Standard Equipment:** Side Grip.

AVAILABLE VARIANTS	
2.0Ah	"Z" VARIANT
<b>HP002G A2</b> INCLUDES 2 BATTERIES / 1 CHARGER / MAKPAC CONNECTOR CASE	<b>HP002G Z</b> TOOL ONLY (DOES NOT INCLUDE BATTERY/ CHARGER / CARRYING CASE)

**DHP486** - 13mm 18V | **LXT**



**Cordless Percussion Driver Drill**





**Increased performance in continuous heavy-duty applications**

- Increased max clutch torque enables to adjust clutch torque even when tightening fasteners into hard material
- Durable aluminium gear housing
- Mechanical 2 speed gearing with all metal gear construction
- XPT technology that protects against dust & moisture
- Compact and ergonomic design at only 178 mm long
- 21 torque settings

<b>Capacity</b>	Steel: 13 mm (1/2") Wood (Auger-Bit): 50 mm (2")   Wood (Self-Feed Bit): 76 mm (3") Siding Board: 170 mm (6-11/16")
<b>Chuck Capacity</b>	1.5 - 13 mm (1/16 - 1/2")
<b>Impacts Per Minute (IPM)</b>	High / Low: 0 - 31,500 / 0 - 8,250
<b>No Load Speed (RPM)</b>	High / Low: 0 - 2,100 / 0 - 550
<b>Max Fastening Torque</b>	Hard / Soft: 130 / 65 N.m
<b>Dimensions (L x W x H)</b>	178 x 81 x 265 mm
<b>Net weight</b>	2.7 kg

**Standard Equipment:** (+)(-) bit, Side grip

AVAILABLE VARIANTS		
5.0Ah	3.0Ah	"Z" VARIANT
<b>DHP486 RTJ</b> INCLUDES 2 BATTERIES / 1 CHARGER / MAKPAC CONNECTOR CASE	<b>DHP486 RFJ</b> INCLUDES 2 BATTERIES / 1 CHARGER / MAKPAC CONNECTOR CASE	<b>DHP486 Z</b> TOOL ONLY (DOES NOT INCLUDE BATTERY / CHARGER / CARRYING CASE)

**DHP481** - 13mm 18V | **LXT**



**Cordless Percussion Driver Drill**





**Newly developed large brushless motor provides higher power and productivity.**

- Features the highest torque in the industry.
- Compact tool size with an overall length of 205mm.

<b>Capacity</b>	Steel: 13mm / Wood : 76mm Masonry : 16mm
<b>Impacts per minute (ipm)</b>	Hi : 0-31,500 / Lo : 0-8,250
<b>No load speed (rpm)</b>	Hi : 0-2,100 / Lo : 0-550
<b>Max fastening torque</b>	Hard / Soft : 115 / 60N m
<b>Dimensions (L x W x H)</b>	205x79x249mm
<b>Net weight</b>	2.8kg

**Standard Equipment:** (+)(-) bit, Side Grip, Belt clip

AVAILABLE VARIANTS		
5.0Ah	3.0Ah	"Z" VARIANT
<b>DHP481 RTJ</b> INCLUDES 2 BATTERIES / 1 CHARGER / MAKPAC CONNECTOR CASE	<b>DHP481 RFJ</b> INCLUDES 2 BATTERIES / 1 CHARGER / MAKPAC CONNECTOR CASE	<b>DHP481 Z</b> TOOL ONLY (DOES NOT INCLUDE BATTERY / CHARGER / CARRYING CASE)

- DRILLING / FIXING
- CONCRETE DRILLING / DEMOLITION
- MIXING / STIRRING
- CUTTING (CONCRETE / METAL)
- GRINDING
- SANDING / POLISHING
- SAWING
- MULTI-TOOL
- ROUTERS / PLANERS
- NAILERS / STAPLERS
- HEAT GUN / LASER
- CLEANING
- OPE
- JOBSITE TOOLS
- SPECIALTY TOOLS
- HAND TOOLS / COMBINATION SET
- TOOL HOLDERS AND POUCHES / MAKPAC SYSTEM

DRILLING / FIXING

**DHP489** 13mm 18V | **LXT**

**Cordless Percussion Driver Drill**



**Powerful Brushless motor & Compact and ergonomic design**

- Delivers more drilling, driving and fastening speed
- Aluminum gear housing creates an impression of rigidity and luxuriousness
- Variable 2-speed for a wide range of drilling and fastening applications
- Built-in twin LED lights with pre-glow and afterglow functions illuminate the work area



<b>Capacity</b>	Masonry / Steel / Wood: 16 / 13 / 38 mm
<b>Chuck capacity</b>	1.5 - 13 mm
<b>Impacts per minute (ipm)</b>	High / Low: 0 - 27,000 / 0 - 8,250
<b>No Load Speed (RPM)</b>	High / Low: 0 - 1,800 / 0 - 550
<b>Max Fastening Torque</b>	Hard / Soft: 70 / 36 N m
<b>Dimensions (L x W x H)</b>	175x81x244 mm
<b>Net weight</b>	1.9 kg

**Standard Equipment:** (+)(-) bit, Belt clip

AVAILABLE VARIANTS

5.0Ah	"Z" VARIANT
<b>DHP489 RTJ</b> INCLUDES 2 BATTERIES / 1 CHARGER / PLASTIC CARRYING CASE	<b>DHP489 Z</b> TOOL ONLY (DOES NOT INCLUDE BATTERY / CHARGER / CARRYING CASE)

CONCRETE DRILLING / DEMOLITION

MIXING / STIRRING

CUTTING (CONCRETE / METAL)

GRINDING

SANDING / POLISHING

SAWING

MULTI-TOOL

ROUTERS / PLANERS

NAILERS / STAPLERS

HEAT GUN / LASER

CLEANING

OPE

SPECIALTY TOOLS

HAND TOOLS / COMBINATION SET

TOOL HOLDERS AND POUCHES / MAKPAC SYSTEM

**DHP484** 13mm 18V | **LXT**

**Cordless Percussion Driver Drill**



**Powerful Brushless motor & Compact and ergonomic design**

- Delivers more drilling, driving and fastening speed
- Aluminum gear housing creates an impression of rigidity and luxuriousness
- Variable 2-speed for a wide range of drilling and fastening applications
- Built-in twin LED lights with pre-glow and afterglow functions illuminate the work area



<b>Capacity</b>	Masonry / Steel / Wood: 13 / 13 / 38 mm
<b>Chuck capacity</b>	1.5 - 13 mm
<b>Impacts per minute (ipm)</b>	High / Low: 0 - 30,000 / 0 - 7,500
<b>No Load Speed (RPM)</b>	High / Low: 0 - 2,000 / 0 - 500
<b>Max Fastening Torque</b>	Hard / Soft: 54 / 30 N m
<b>Dimensions (L x W x H)</b>	182x79x261 mm
<b>Net weight</b>	1.9 kg

**Standard Equipment:** (+)(-) bit, Belt clip

AVAILABLE VARIANTS

5.0Ah
<b>DHP484 RTJ</b> INCLUDES 2 BATTERIES / 1 CHARGER / PLASTIC CARRYING CASE

**DHP487** 13mm 18V | **LXT**

**Cordless Percussion Driver Drill**



**Ultra compact design and lightweight**

- Mechanical 2 speed gearing
- 1,700rpm no load speed motor delivers fast driving performance
- XPT technology that protects against dust & moisture
- Twin LED Job light with after-glow function



<b>Capacity</b>	Steel / Wood (Auger Bit) / Wood (Self-Feed Bit) / Wood (Hole Saw) / Masonry : 13 / 36 / 35 / 51 / 13 mm
<b>Chuck Capacity</b>	1.5 - 13 mm (1/16 - 1/2")
<b>Impacts Per Minute (IPM)</b>	High / Low: 0 - 25,500 / 0 - 7,500
<b>No Load Speed (RPM)</b>	High / Low: 0 - 1,700 / 0 - 500
<b>Max Fastening Torque</b>	Hard / Soft: 40 / 25 N-m
<b>Dimensions (L x W x H)</b>	164 x 81 x 248 mm
<b>Net weight</b>	1.7kg

**Standard Equipment:** (+)(-) bit, Side Grip, Belt clip

AVAILABLE VARIANTS

5.0Ah	3.0Ah	3.0Ah	"Z" VARIANT
<b>DHP487 RTJ</b> INCLUDES 2 BATTERIES / 1 CHARGER / MAKPAC CONNECTOR CASE	<b>DHP487 RFJ</b> INCLUDES 2 BATTERIES / 1 CHARGER / MAKPAC CONNECTOR CASE	<b>DHP487 RF1J</b> INCLUDES 1 BATTERY / 1 CHARGER / MAKPAC CONNECTOR CASE	<b>DHP487 Z</b> TOOL ONLY (DOES NOT INCLUDE BATTERY / CHARGER / CARRYING CASE)

**DHP453** 13mm 18V | **LXT**

**Cordless Percussion Driver Drill**



**All metal gear construction ensures high transmission durability.**

- Single sleeve keyless chuck enables easy bit installation/removal with one hand.
- Ergonomically designed rubberized soft grip provides more control and comfort.



<b>Capacity</b>	Steel / Wood / Masonry: 13 / 36 / 13 mm
<b>Chuck capacity</b>	1.5 - 13 mm
<b>Impacts Per Minute (IPM)</b>	Hi : 0-19,500 Lo : 0-6,000
<b>No Load Speed (RPM)</b>	Hi : 0-1,300 Lo : 0-400
<b>Max Fastening Torque</b>	Hard / Soft : 42 / 27N m
<b>Dimensions (L x W x H)</b>	239x79x244mm
<b>Net weight</b>	2.0kg

**Standard Equipment:** (+)(-) bit, Belt clip

AVAILABLE VARIANTS

3.0Ah
<b>DHP453 RFE</b> INCLUDES 2 BATTERIES / 1 CHARGER / PLASTIC CARRYING CASE

**HP333D** 10mm (3/8") **12V MAX | CXT**

**Cordless Percussion Driver Drill**



**Compact and ergonomic design with only 193mm length**

- Ball bearing reduces chuck wobbling
- Slide style battery and improved ergonomic grip
- Variable 2-speed (0-450 & 0-1,700 RPM) for a wide range of drilling, fastening and hammer drilling applications
- Increased motor power for higher application speed and max tightening torque



<b>Capacity</b>	Steel / Wood / Masonry: 10 / 21 / 8 mm
<b>Impacts per minute (ipm)</b>	High / Low: 0 - 25,500 / 0 - 6,750
<b>No load speed (rpm)</b>	High / Low: 0 - 1,700 / 0 - 450
<b>Max tightening torque</b>	Hard / Soft: 30 / 14 N m
<b>Max lock torque</b>	28 N m
<b>Dimensions (L x W x H)</b>	193x66x212 mm
<b>Net weight</b>	1.3 kg

**Standard Equipment:** Belt clip

AVAILABLE VARIANTS		
2.0Ah	2.0Ah	"Z" Version
<b>HP333D WAX1</b> INCLUDES 74PCS ACC SET + 2 BATTERIES / 1 CHARGER / CARRYING CASE	<b>HP333D WAE</b> INCLUDES 2 BATTERIES / 1 CHARGER / CARRYING CASE	<b>HP333D Z</b> TOOL ONLY (DOES NOT INCLUDE BATTERY / CHARGER OR CARRY CASE)

**HP333D WAX1 (with Accessories kit)**

**74Pcs ACCESSORIES KIT**

- 2pcs of Phillips bit (long)
- 2pcs of Pozi bit (long)
- 2pcs of Torx bit (long)
- 2pcs of Slotted bit (long)
- 10pcs of Phillips bit
- 8pcs of Slotted bit
- 10pcs of Pozi bit
- 8pcs of Torx bit
- 4pcs of Hex bit
- 4pcs of Socket
- 5pcs of Masonry bit
- 8pcs of H.S.S drill bit
- 5pcs of Wood drill bit
- 2pcs of Flat bit
- 1pc of Magnetic bit holder
- 1pc of Countersink

**2 BATTERIES OF 2.0Ah**

**1 CHARGER**



**PERCUSSION DRIVER DRILL**

**HP332D** 10mm (3/8") **12V MAX | CXT**

**Cordless Percussion Driver Drill**



**More compact and more work amount thanks to the newly developed brushless motor and 10.8V slide Li-ion battery**

- High rotational speed
- Best possible ergonomic handle for drilling/driving applications
- Battery protection circuit is activated on high battery temperature to protect the battery from damages due to overdischarge, high temperature or overload current.
- 10mm (3/8") single sleeve keyless drill chuck with click sound to indicate that drill bit is fully locked
- Single LED job light with pre-glow and afterglow functions



<b>Capacity</b>	Steel : 10mm (3/8") Wood : 28mm (1-1/8") Masonry : 8mm (5/16")
<b>Impacts per minute (ipm)</b>	Hi : 0-22,500 / Lo : 0-6,750
<b>No load speed (rpm)</b>	Hi : 0-1,500 / Lo : 0-450
<b>Max tightening torque</b>	Hard / Soft : 35 / 21N m
<b>Dimensions (L x W x H)</b>	168x66x217mm (6-5/8"x2-5/8"x8-1/2")
<b>Net weight</b>	1.1kg (2.5lbs)

**Standard Equipment:** Belt clip, Phillips bit

AVAILABLE VARIANTS	
2.0Ah	"Z" Version
<b>HP332D WAE</b> INCLUDES 2 BATTERIES / 1 CHARGER / CARRYING CASE	<b>HP332D Z</b> TOOL ONLY (DOES NOT INCLUDE BATTERY / CHARGER OR CARRY CASE)

**HP0300** 10mm **AG**

**Percussion Driver Drill**



**Excellent usability and compact**

- Compact and lightweight design.
- 2 sleeve keyless Drill chuck allows for easy bit installation/ removal by one hand
- Mechanical 2-speed gearing
- 20 Torque settings
- Ergonomic handle with soft grip for driver-drill applications
- Variable speed control by trigger



<b>Continuous rating input</b>	320W
<b>Capacity</b>	Concrete / Steel / Wood: 8 / 10 / 28mm
<b>Chuck Capacity</b>	1.0 - 10 mm
<b>No Load Speed (RPM)</b>	High / Low: 0 - 1,500 / 0 - 450
<b>Blows Per Minute (BPM)</b>	High / Low: 0 - 22,500 / 0 - 6,750
<b>Max Fastening Torque</b>	Hard / Soft: 56.0 / 21.0 N m
<b>Max lock torque</b>	42.0 N m
<b>Vibration Level</b>	Impact Drilling into Concrete: 12.5 m/s <sup>2</sup> Drilling into Metal: 2.5 m/s <sup>2</sup> or less
<b>Sound Pressure Level</b>	82 dB(A)
<b>Sound Power Level</b>	93 dB(A)
<b>Dimensions (L x W x H)</b>	235x67x206 mm
<b>Net weight</b>	1.3 kg
<b>Power supply cord</b>	2.5 m

- DRILLING / FIXING
- CONCRETE DRILLING / DEMOLITION
- MIXING / STIRRING
- CUTTING (CONCRETE / METAL)
- GRINDING
- SANDING / POLISHING
- SAWING
- MULTI-TOOL
- ROUTERS / PLANERS
- NAILERS / STAPLERS
- HEAT GUN / LASER
- CLEANING
- OPE
- JOB SITE TOOLS
- SPECIALTY TOOLS
- HAND TOOLS / COMBINATION SET
- TOOL HOLDERS AND POUCHES / MAKPAC SYSTEM

- DRILLING / FIXING
- CONCRETE DRILLING / DEMOLITION
- MIXING / STIRRING
- CUTTING (CONCRETE / METAL)
- GRINDING
- SANDING / POLISHING
- SAWING
- MULTI-TOOL
- ROUTERS / PLANERS
- NAILERS / STAPLERS
- HEAT GUN / LASER
- CLEANING
- OPE
- JOBSITE TOOLS
- SPECIALTY TOOLS
- HAND TOOLS / COMBINATION SET
- TOOL HOLDERS AND POUCHES / MAKPAC SYSTEM

Comparison Chart - Percussion Driver Drill Range

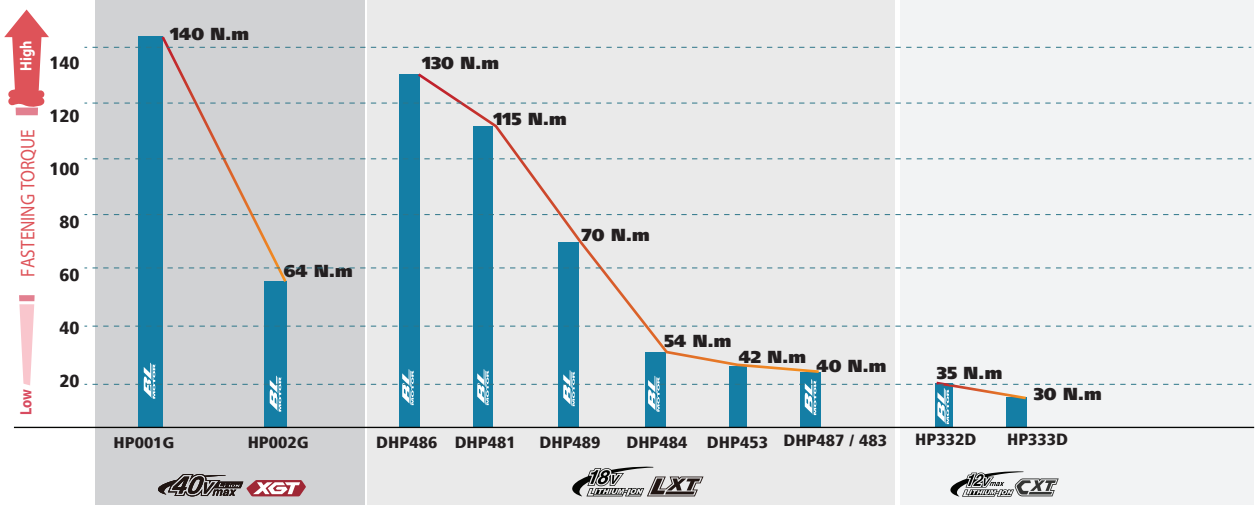

Model No.	Voltage	No load speed (rpm)	Impacts per minute (ipm)	Mechanical Speed	Torque Setting	Max. fastening torque Hard / Soft (N-m)	Overall length (mm)	Net weight (kg)	BL motor
HP001G	40V MAX XGT	0-2,600 / 650	0-39,000 / 9,750	2-Speed	21 / 41	140 / 68	181	2.0kg	●
HP002G		0-2,200 / 600	0-33,000 / 9,000	2-Speed	21	64 / 30	164	1.3kg	●
DHP486	18V LXT	0-2,100 / 550	0-31,500 / 8,250	2-Speed	21	130 / 65	178	2.7kg	●
DHP481		0-2,100 / 550	0-31,500 / 8,250	2-Speed	21	115 / 60	205	2.8kg	●
DHP489		0 - 1,800 / 550	0-27,500 / 8,250	2-Speed	21	70 / 36	174	1.9kg	●
DHP484		0-2,000 / 500	0-30,000 / 7,500	2-Speed	21	54 / 30	172	1.9kg	●
DHP453	18V LXT	0-1,300 / 0-400	0-19,500 / 6,000	2-Speed	16	42 / 27	223	2.0kg	-
DHP487		0-1,700 / 500	0-25,500 / 7,500	2-Speed	20	40 / 25	150	1.7 kg	●
HP332D	12V CXT	0-1,500 / 450	0-25,500 / 6,750	2-Speed	20	35 / 21	154	1.3 kg	●
HP333D		0-1,700 / 450	0-25,500 / 6,750	2-Speed	20	30 / 14	179	1.1 kg	-
HP0300	320W	0-1,500 / 0- 450	0-22,500 / 6,750	2-Speed	20	56 / 21	235	1.3 kg	-





- DRILLING / FIXING
- CONCRETE DRILLING / DEMOLITION
- MIXING / STIRRING
- CUTTING (CONCRETE / METAL)
- GRINDING
- SANDING / POLISHING
- SAWING
- MULTI-TOOL
- ROUTERS / PLANERS
- NAILERS / STAPLERS
- HEAT GUN / LASER
- CLEANING
- OPE
- JOBSITE TOOLS
- SPECIALTY TOOLS
- HAND TOOLS / COMBINATION SET
- TOOL HOLDERS AND POUCHES / MAKPAC SYSTEM

## DDA351 10mm

18V | **LXT**

Cordless Angle Drill



**Compact angle head with small head height.**

- Original 4-pole motor for power, lightweight and compact size.
- LED job light with afterglow function.
- Ergonomically designed rubberized soft grip.
- Easy-to-operate large type (paddle type) switch trigger.
- Single sleeve keyless chuck enables easy bit installation / removal by one hand.



<b>Capacity</b>	Steel : 10mm (3/8") Wood : 25mm (1")
<b>No load speed (rpm)</b>	0-1,800
<b>Dimensions (L x W x H)</b>	326x79x115mm
<b>Net weight</b>	1.9kg

**Standard Equipment:** Side grip.

AVAILABLE VARIANTS

3.0Ah	"Z" VARIANT
<b>DDA351 RFE</b> <small>INCLUDES 2 BATTERIES / 1 CHARGER / PLASTIC CARRYING CASE</small>	<b>DDA351 Z</b> <small>TOOL ONLY (DOES NOT INCLUDE BATTERY / CHARGER OR CARRY CASE)</small>

## DA332D 10mm

12V MAX | **CXT**

Cordless Angle Drill

**Compact Angle Head Height & Center Height for Use in Close Quarters**

- Up to 40% faster drilling and 380% longer runtime
- Slide style battery and improved ergonomic grip
- Part of the expanding 12V max CXT series, combining performance with superior ergonomics in a compact size
- Multi-contact terminals ensure stable contact with battery even under extreme vibration



<b>Capacity</b>	Steel: 10 mm / Wood: 12 mm /
<b>No Load Speed (RPM)</b>	0 - 1,100
<b>Head Height</b>	63 mm (2-1/2")
<b>Center Height</b>	23.5 mm (15/16")
<b>Dimensions (L x W x H)</b>	with BL1021B : 313x68x86 mm
<b>Net weight</b>	1.2kg

**Standard Equipment:** Bit, Belt Clip, Chuck Key, Chuck Key Holder



AVAILABLE VARIANTS

2.0Ah	"Z" Version
<b>DA332D SAJ</b> <small>INCLUDES 2 BATTERIES / 1 CHARGER / MAKPAC CONNECTOR CASE</small>	<b>DA332D Z</b> <small>TOOL ONLY (DOES NOT INCLUDE BATTERY / CHARGER OR CARRY CASE)</small>

## DA4000LR 13mm

AC

Angle Drill

**Easy to turn over, new angle attachment for quick High (0-900rpm) / Low (0-400rpm) speed change.**

- Enhanced gears in angled attachment for heavy duty industrial use.
- Ergonomic soft grip for superior handling.



<b>Continuous rating input</b>	710W
<b>Drilling capacities</b>	Steel : 13mm (1/2") Wood (self-feed bit) Hi : 65mm (2-9/16") Wood (self-feed bit) Lo : 118mm (4-5/8") Wood (Hole saw) Hi : 114mm (4-1/2") Wood (Hole saw) Lo : 152mm (6")
<b>No load speed</b>	Hi : 0-900rpm Lo : 0-400rpm
<b>Overall length</b>	413mm (16-1/4")
<b>Net weight</b>	4.0kg (8.9lbs)
<b>Power supply cord</b>	2.5m (8.2ft)

**Standard Equipment:** Angle Attachment, Chuck Key, Hex Wrench, Grip.

## DA3010 10mm

AC

Angle Drill

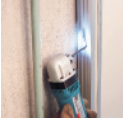
**Compact and light body weighs only 1.6kg (3.5 lbs)**

- Only 66mm (2-5/8") in head height.
- With keyed chuck.



<b>Continuous rating input</b>	450 W
<b>Capacity</b>	Steel : 10 mm (3/8") Wood : 25 mm (1")
<b>No load speed</b>	0 – 2,400 rpm
<b>Overall length</b>	270 mm (10-5/8")
<b>Net weight</b>	1.6 kg (3.5 lbs)
<b>Power supply cord</b>	2.5 m (8.2 ft.)

**Standard Equipment:** Chuck Key.



**6501 6.5mm** 

**High Speed Drill**



**With depth gauge for uniform hole depth**

- With 4,500 rpm high speed rotation, ideal for fast drilling for small holes.
- Compact body weighs only 0.9kg for superior handling.



<b>Continuous rating input</b>	230W
<b>Capacity</b>	Steel : 6.5 mm (1/4") Wood : 9 mm (11/32")
<b>No load speed</b>	4,500 rpm
<b>Overall length</b>	206 mm (8-1/8")
<b>Net weight</b>	0.9 kg (2.0 lbs)
<b>Power supply cord</b>	2.0 m (6.6 ft)

**Standard Equipment:** Chuck Key, Stopper Pole.

**DP2010 6.5mm** 

**High Speed Drill**



**Compact body with elastomer grip to provide maximum comfort and control**

- Designed For High Drilling Efficiency
- With 4,200 RPM high speed rotation, ideal for fast drilling of small holes
- In-line positive grip design maximises power thrust
- Forward / Reverse rotation change by lever
- 2 sleeve keyless Drill chuck allows for easy bit installation/ removal by one hand
- Trigger switch with variable speed control function by dial



<b>Continuous rating input</b>	370W
<b>Capacity</b>	Steel: 6.5 mm Wood: 15 mm
<b>No Load Speed</b>	0-4,200 rpm
<b>Dimensions (L x W x H)</b>	209x64x175 mm
<b>Net weight</b>	1.0 kg
<b>Power supply cord</b>	2.0 m

**6010B 10mm** 

**Drill**



**Very popular drill for one-hand operation**

- Features single speed switch.



<b>Continuous rating input</b>	305W
<b>Capacity</b>	Steel : 10 mm (3/8") Wood : 15 mm (5/8")
<b>No load speed</b>	1,800 rpm
<b>Overall length</b>	233 mm (9-1/4")
<b>Net weight</b>	1.5 kg (3.5 lbs)
<b>Power supply cord</b>	2.5 m (8.2ft)

**6408 10mm** 

**Drill**



**Variable speed (0-2,500rpm) for drilling in a variety of materials**

- In-line handle design for maximum power thrust.
- Low noise level for quieter operation.
- With keyless chuck.



<b>Continuous rating input</b>	530 W
<b>Capacity</b>	Steel : 10 mm (3/8") Wood : 25 mm (1")
<b>No load speed</b>	0 – 2,500 rpm
<b>Overall length</b>	261 mm (10-1/4")
<b>Net weight</b>	1.5 kg (3.2 lbs)
<b>Power supply cord</b>	2.5 m (8.2 ft.)

- DRILLING / FIXING
- CONCRETE DRILLING / DEMOLITION
- MIXING / STIRRING
- CUTTING (CONCRETE / METAL)
- GRINDING
- SANDING / POLISHING
- SAWING
- MULTI-TOOL
- ROUTERS / PLANERS
- NAILERS / STAPLERS
- HEAT GUN / LASER
- CLEANING
- OPE
- JOB SITE TOOLS
- SPECIALTY TOOLS
- HAND TOOLS / COMBINATION SET
- TOOL HOLDERS AND POUCHES / MAKPAC SYSTEM

DRILLING / FIXING

CONCRETE DRILLING / DEMOLITION

MIXING / STIRRING

CUTTING (CONCRETE / METAL)

GRINDING

SANDING / POLISHING

SAWING

MULTI-TOOL

ROUTERS / PLANERS

NAILERS / STAPLERS

HEAT GUN / LASER

CLEANING

OPE

JOBSITE TOOLS

SPECIALTY TOOLS

HAND TOOLS / COMBINATION SET

TOOL HOLDERS AND POUCHES / MAKPAC SYSTEM

**6413 10mm** 

**Drill**



**Compact and lightweight, yet with enough power**

- Ergonomically designed handle with rubberized grip provides more control and comfort.
- Chuck capacity: 1.5-10mm (1/16"-3/8").
- In-line design brings drilling pressure in line with center of drill bit axis.
- All ball bearing construction ensures high durability.



<b>Continuous rating input</b>	450W
<b>Capacity</b>	Steel : 10mm (3/8") Wood : 25mm (1")
<b>No load speed</b>	0-3,400 rpm
<b>Dimensions (L x W x H)</b>	234 x 64 x 183mm (9-1/4" x 2-1/2" x 7-1/4")
<b>Net weight</b>	1.3kg (2.9lbs)
<b>Power supply cord</b>	2.0m (6.6ft)

**DP4700 13mm** 

**Drill**



**Heavy-duty performance drill for professionals**

- Variable speed (0-550 rpm) for versatility.
- Weighs only 2.2 kg for easy handling.
- Rugged industrial chuck.



<b>Continuous rating input</b>	510 W
<b>Capacity</b>	Steel : 13 mm (1/2") Wood : 36 mm (1-3/8")
<b>No load speed</b>	0 – 550 rpm
<b>Overall length</b>	275 mm (10-7/8")
<b>Net weight</b>	2.2 kg (4.8 lbs)
<b>Power supply cord</b>	2.5 m (8.2 ft.)

**Standard Equipment:** Chuck Key, Grip

**6305 13mm** 

**Drill**



**Rear handle with soft rubber grip, ergonomically designed for comfortable operation**

- Warning lamp that indicates trouble with the cord, the switch or the motor
- Designed for installation on Type-43 drill stand.
- Double Insulated Construction



<b>Continuous rating input</b>	850W
<b>Capacity</b>	Steel: 13 mm (1/2") Wood: 30 mm (1-3/16")
<b>No Load Speed (RPM)</b>	1,450
<b>Dimensions (L x W x H)</b>	346x84x152 mm
<b>Net weight</b>	2.8 kg
<b>Power supply cord</b>	2.5 m



**Standard Equipment:** Chuck Key, Depth Gauge Assembly, Grip.

**Drill with spade handle (DS5000 / DS4011)**



**DS4011 13mm** 

**Drill (with spade handle)**

**New aesthetic design**

- High performance.
- Full 360 degree rotatable D-handle with 24 positive stops for multi-position operation.





<b>Continuous rating Input</b>	750W
<b>Capacity</b>	Steel : 13mm
	Wood : 36mm
<b>No load speed</b>	600 rpm
<b>Dimensions (L x W x H)</b>	340 x 83 x 401mm
<b>Net weight</b>	2.8kg
<b>Power supply cord</b>	2.5m

**Standard Equipment:** Chuck Key, Side Grip

**DS5000 16mm** 

**Drill (with spade handle)**

**New aesthetic design with 16mm drilling capacity.**

- High performance.
- Full 360 degree rotatable D-handle with 24 positive stops for multi-position operation.



<b>Continuous rating input</b>	750W
<b>Capacity</b>	Steel: 16 mm
	Wood: 36 mm
<b>No Load Speed</b>	600 rpm
<b>Dimensions (L x W x H)</b>	348x83x401 mm
<b>Net weight</b>	3.0 kg
<b>Power supply cord</b>	2.5 m

**Standard Equipment:** Chuck Key, Side Grip

**Drill Press**



**TB131 13mm** 

**Drill Press**



**Compact Drill Press.**

- 5 mode speed.
- Turn table (right or left : 45 degrees).



<b>Continuous rating input</b>	250 W
<b>HP</b>	1/3
<b>Drilling capacity</b>	Steel : 13 mm (1/2")
	Wood : 24 mm (15/16")
<b>No load speed</b>	570, 890, 1300, 1900, 2670 (50Hz) rpm 690, 1070, 1560, 2280 3,200 (60Hz) rpm
<b>Net weight</b>	20 kg (44.1 lbs)
<b>Power supply cord</b>	1.75 m (5.7 ft)

**Standard Equipment:** Chuck Key, Wrench.

- DRILLING / FIXING
- CONCRETE DRILLING / DEMOLITION
- MIXING / STIRRING
- CUTTING (CONCRETE / METAL)
- GRINDING
- SANDING / POLISHING
- SAWING
- MULTI-TOOL
- ROUTERS / PLANERS
- NAILERS / STAPLERS
- HEAT GUN / LASER
- CLEANING
- OPE
- JOB SITE TOOLS
- SPECIALTY TOOLS
- HAND TOOLS / COMBINATION SET
- TOOL HOLDERS AND POUCHES / MAKPAC SYSTEM

DRILLING /  
FIXING

CONCRETE  
DRILLING /  
DEMOLITION

MIXING /  
STIRRING

CUTTING  
(CONCRETE /  
METAL)

GRINDING

SANDING /  
POLISHING

SAWING

MULTI-TOOL

ROUTERS /  
PLANERS

NAILERS /  
STAPLERS

HEAT GUN /  
LASER

CLEANING

OPE

JOBSITE  
TOOLS

SPECIALTY  
TOOLS

HAND TOOLS /  
COMBINATION SET

TOOL HOLDERS  
AND POUCHES /  
MAKPAC SYSTEM

## Impact Drill



## HP1230 12mm



### Impact Drill



#### Aluminium gear housing provides high quality and toughness.

- Compact and lightweight design.
- 2 operation modes - hammering with rotation and rotation only.
- Ergonomically designed handle with rubberized grip provides more control and comfort.
- Easy-to-operate large trigger switch and lock-on button.



<b>Continuous rating Input</b>	400W
<b>Capacity</b>	Brick / Masonry : 12mm (15/32") Steel : 10mm (3/8") Wood : 15mm (9/16")
<b>Impacts per minute (ipm)</b>	0 - 31,900
<b>No load speed (rpm)</b>	0 - 2,900
<b>Dimensions (L x W x H)</b>	239 x 67 x 188mm (9-3/8" x 2-5/8" x 7-3/8")
<b>Net weight</b>	1.6kg (3.6lbs)
<b>Power supply cord</b>	2.0m (6.6ft)

**Standard Equipment:** Chuck Key, Depth Gauge, Side Handle.

## NHP1320S 13mm



### Impact Drill



#### A best seller worldwide due to amazing reliability.

- Upgraded, 13mm version of NHP1030.



<b>Continuous rating input</b>	430W
<b>Capacity</b>	Brick / Masonry : 13 mm (1/2") Steel : 13 mm (1/2") Wood : 18 mm (11/16")
<b>Blows per minute</b>	29,700 bpm
<b>No load speed</b>	2,700 rpm
<b>Overall length</b>	278 mm (10-7/8")
<b>Net weight</b>	1.7 kg (3.7 lbs)
<b>Power supply cord</b>	2 m (6.6 ft)

**Standard Equipment:** Chuck Key, Grip.

## 8419B2 19mm



### 2-Speed Impact Drill



#### Industrial metal gear housing for durability and long tool life.

- Powerful 600W motor for Heavy-duty applications.



<b>Continuous rating Input</b>	600 W
<b>Capacity</b>	Brick / Masonry: 19 mm (3/4") Steel: 13 mm (1/2") Wood: 30 mm (1-3/16")
<b>No load speed</b>	Hi : 2,300 rpm Lo : 900 rpm
<b>Blows per minute</b>	Hi : 46,000 Lo : 18,000
<b>Overall length</b>	350 mm (13-3/4")
<b>Net weight</b>	3 kg (6.6 lbs.)
<b>Power supply cord</b>	2.5 m (8.2 ft.)

**Standard Equipment:** Chuck Key, Grip Assembly, Depth Rod.

**8420V 20mm**



**Impact Drill**



**A powerful tool with a convenient variable speed feature.**

- A flick of the switch for your choice of either hammering+rotation or rotation only.
- A powerful tool with a convenient, variable speed feature.
- Tough aluminium-clad body for heavy duty applications.



<b>Continuous rating input</b>	660W
<b>Capacity</b>	Brick / Masonry: 20 mm (3/4") Steel: 13 mm (1/2") Wood: 30 mm (1-3/16")
<b>Blows per minute</b>	0 – 21,000 bpm
<b>No load speed</b>	0 – 1,400 rpm
<b>Overall length</b>	368 mm (14-1/2")
<b>Net weight</b>	3 kg (6.6 lbs)
<b>Power supply cord</b>	2.5 m (8.2 ft)

**Standard Equipment:** Chuck Key, Grip Assembly, Depth Rod.

**HP1630K 16mm**



**Impact Drill**



**High power motor**

- Sturdy Aluminum Gear Housing Cover
- Sturdy Cylinder-shaped Motor Housing



<b>Continuous rating Input</b>	710W
<b>Capacity</b>	Brick / Masonry: 16mm (5/8") Steel : 13mm (1/2") Wood: 30mm (1-3/16")
<b>Impacts per minute</b>	0-48,000 ipm
<b>No load speed</b>	0-3,200 rpm
<b>Dimension (L x W x H)</b>	296 x 75 x 204mm
<b>Net weight</b>	2.1kg
<b>Power supply cord</b>	2.0m

**Standard Equipment:** Side Grip, Chuck key

**HP1640 16mm**



**Impact Drill**



**Dual purpose for "Rotation only" and "Rotation with hammering".**

- New reversing system allows extended service life of carbon brush.
- No power reduction even in reverse rotation.
- In-line positive grip design maximizes power thrust.
- Large trigger switch for easy operation.



**Standard Equipment:** Side Grip, Depth Gauge, Chuck Key



**Specifications:-**

	<b>HP1640K</b>	<b>HP1640KX2</b>	<b>HP1640KX3</b>
<b>Continuous rating Input</b>	680W	680W	680W
<b>Capacity</b>	Brick / Masonry: 16mm (5/8") Steel: 13mm (1/2") Wood: 30mm (1-3/16")	Brick / Masonry: 16mm (5/8") Steel: 13mm (1/2") Wood: 30mm (1-3/16")	Brick / Masonry: 16mm (5/8") Steel: 13mm (1/2") Wood: 30mm (1-3/16")
<b>Impacts per minute</b>	0-44,800 ipm	0-44,800 ipm	0-44,800 ipm
<b>No load speed</b>	0-2,800 rpm	0-2,800 rpm	0-2,800 rpm
<b>Dimensions (L x W x H)</b>	303 x 72 x 222mm	303 x 72 x 222mm	303 x 72 x 222mm
<b>Net weight</b>	2.0kg (4.4lbs)	2.0kg (4.4lbs)	2.0kg (4.4lbs)
<b>Power supply cord</b>	2.0m (6.6ft)	2.0m (6.6ft)	2.0m (6.6ft)

**Accessories Set**



(Only Tool)

**18Pcs Drill Set with Special Carry Case**



18pcs Drill set

**74pcs Driver Set with Carry Case**



74pcs driver drill set

DRILLING / FIXING

CONCRETE DRILLING / DEMOLITION

MIXING / STIRRING

CUTTING (CONCRETE / METAL)

GRINDING

SANDING / POLISHING

SAWING

MULTI-TOOL

ROUTERS / PLANERS

NAILERS / STAPLERS

HEAT GUN / LASER

CLEANING

OPE

JOBSITE TOOLS

SPECIALTY TOOLS

HAND TOOLS / COMBINATION SET

TOOL HOLDERS AND POUCHES / MAKPAC SYSTEM

DRILLING / FIXING

CONCRETE DRILLING / DEMOLITION

MIXING / STIRRING

CUTTING (CONCRETE / METAL)

GRINDING

SANDING / POLISHING

SAWING

MULTI-TOOL

ROUTERS / PLANERS

NAILERS / STAPLERS

HEAT GUN / LASER

CLEANING

OPE

JOBSITE TOOLS

SPECIALTY TOOLS

HAND TOOLS / COMBINATION SET

TOOL HOLDERS AND POUCHES / MAKPAC SYSTEM

HP2050 20mm



2-Speed Impact Drill



Slender and compact body with durable metal gear housing.

- Extra-low vibration level for reduced operator fatigue.
- Dual purpose for "Rotation Only" and "Rotation with hammering".
- Built-in torque limiter stops bit rotation when hitting reinforcements.
- Industrial strength keyed chuck.
- Features a built-in LED job light.



Continuous rating Input	720W
Capacity	Brick / Masonry : 20mm (3/4") Steel Hi : 8mm (5/16") Steel Lo : 13mm (1/2") Wood Hi : 25mm (1") Wood Lo : 40mm (1-9/16")
Impacts per minute (ipm)	Hi : 0-58,000 Lo : 0-24,000
No load speed (rpm)	Hi : 0-2,900 Lo : 0-1,200
Overall length	362mm (14-1/4")
Net weight	2.5kg (5.6lbs)
Power supply cord	2.5m (8.2ft)

Standard Equipment: Chuck Key, Grip Assembly, Depth Rod.

HP2010N 20mm



2-Speed Impact Drill



Industrial metal gear housing for long lasting durability.

- Two speed gear change for ideal speed and power.
- Variable speed switch for easy starting of holes.
- Adjustable side handle for greater control.
- With reversible feature.



Continuous rating Input	750 W
Capacity	Brick / Masonry : 20 mm (3/4") Steel : 13 mm (1/2") Wood: 40 mm (1-9/16")
Blows per minute	Hi: 0 – 46,000 Lo: 0 – 18,000
No load speed	Hi: 0 – 2,300 rpm Lo: 0 – 900 rpm
Overall length	350 mm (13-3/4")
Net weight	2.9 kg (6.4 lbs.)
Power supply cord	2.5 m (8.2 ft.)

Standard Equipment: Chuck Key, Grip Assembly, Depth Rod.

HP2000 20mm



2-Speed Impact Drill



Industrial metal gear housing for long lasting durability.

- Fast and steady drilling with powerful 800W motor.
- Two gear ranges for high or low torque variable speed in both ranges for pinpointing hole positioning.



Continuous rating Input	800 W
Capacity	Brick / Masonry: 20 mm (3/4") Steel: 13 mm (1/2") Wood: 40 mm (1-9/16")
No load speed	Hi: 0 – 2,300 rpm Lo: 0 – 900 rpm
Blows per minute	Hi: 0 – 46,000 Lo: 0 – 18,000
Overall length	350 mm (13-3/4")
Net weight	3 kg (6.6 lbs.)
Power supply cord	2.5 m (8.2 ft.)

Standard Equipment: Chuck Key, Grip Assembly, Depth Rod.

HP2070 20mm



2-Speed Impact Drill



High power in slender and compact body with durable metal gear housing (with keyless drill chuck).

- Dual purpose for "Rotation Only" and "Rotation with hammering".
- Built-in torque limiter stops bit rotation when hitting reinforcements.
- New reversing system allows: \*Extended service life of carbon brush, \*No power reduction even in reverse rotation



Continuous rating Input	1,010W
Capacity	Brick / Masonry : 20mm (3/4") Steel Hi : 8mm (5/16") Steel Lo : 16mm (5/8") Wood Hi : 25mm (1") Wood Lo : 40mm (1-9/16")
Impacts per minute (ipm)	Hi : 0-58,000 Lo : 0-24,000
No load speed (rpm)	Hi : 0-2,900 Lo : 0-1,200
Overall length	362mm (14-1/4")
Net weight	2.5kg (5.6lbs)
Power supply cord	2.5m (8.2ft)

Standard Equipment: Side Grip, Depth Rod.

**DBM131** (Wet & Dry) 

**Diamond Core Drill**

Lo Speed: 132mm (5-3/16")  
Hi Speed : 70mm (2-3/4") Wet & Dry



**Heavy duty wet diamond core drill with powerful motor for shock-free and accurate drilling into concrete and natural stone.**

- Electronic torque limitation, speed control and constant speed even under load.



<b>Continuous rating Input</b>	220V: 1,700W / 127V: 1,500W
<b>Capacity</b>	Concrete block (with diamond core bit): 132mm (5-3/16") Concrete (with diamond core bit): 70mm (2-3/4")
<b>Tool holder</b>	(Spindle) : M18
<b>No load speed</b>	Hi : 0-2,300rpm Lo : 0-1100rpm
<b>Net weight</b>	6.1kg (13.4lbs)

**Recommended to be used with stand (P-40082)**

**DBM230** 

**Diamond Core Drill**

Lo speed : 230mm (9.05")  
Hi speed : 60mm (2.36")





**Heavy duty wet Diamond Core drill with a powerful 2,500W motor.**

- With Overload protection; should the bit get jammed a clutch will slip and disengage the bit from the motor.
- LED light is provided to indicate overload
- Equipped with earth leakage breaker





<b>Continuous rating Input</b>	2,500 W
<b>Capacity</b>	Concrete block (with diamond core bit) Low: 230mm Med: 100mm Hi: 60mm
<b>Tool holder</b>	(Spindle) : M18
<b>No load speed</b>	3rd : 1,700rpm 2nd : 1,040rpm 1st : 390rpm
<b>Net weight</b>	11.2kg (24.7lbs)

**ALWAYS use the DBM230 with its Drill Stand Part No. P-54190.**

**HB350** 35mm 

**Magnetic Drill**

**Compact and Lightweight magnetic drill, ideal for working in constrained or elevated spaces**

- Magnetic base, drill stand, and drill machine all in one package system enables for easy setting.
- Powerful magnetic base supports stable and comfortable drilling work.
- Equipped with oil supply system for smooth drilling.





<b>Continuous rating input</b>	1,050W
<b>Capacity (Steel)</b>	35mm
<b>Chuck Capacity (Solid bit size)</b>	13mm
<b>No Load Speed (RPM)</b>	850
<b>Magnetic Clamping force</b>	8,000N
<b>Dimensions (L x W x H)</b>	225 x 195 x 490 mm
<b>Net weight</b>	11.6 kg

**Standard Equipment:** Small oil cup assembly and clip, Safety guard, Polyester safety strap, Allen keys., Carrying case,

**HB500** 50mm 

**Magnetic Drill**

**Heavy duty magnetic drill.**

- Magnetic base, drill stand, and drill machine all in one package system enables for easy setting.
- Powerful magnetic base supports stable and comfortable drilling work.
- Equipped with oil supply system for smooth drilling.



<b>Continuous rating input</b>	1,150 W
<b>Capacity (Steel)</b>	50 mm
<b>Chuck Capacity (Solid bit size)</b>	16mm
<b>No Load Speed (RPM)</b>	350 / 650
<b>Magnetic Clamping force</b>	9,300N
<b>Dimensions (L x W x H)</b>	290 x 150 x 450 mm
<b>Net weight</b>	18,5 kg

**Standard Equipment:** Quick release arbor, Small oil cup assembly and clip, Carrying case, Safety guard, Polyester safety strap, Integral oil feed steady allen keys

- DRILLING / FIXING
- CONCRETE DRILLING / DEMOLITION
- MIXING / STIRRING
- CUTTING (CONCRETE / METAL)
- GRINDING
- SANDING / POLISHING
- SAWING
- MULTI-TOOL
- ROUTERS / PLANERS
- NAILERS / STAPLERS
- HEAT GUN / LASER
- CLEANING
- OPE
- JOBSITE TOOLS
- SPECIALTY TOOLS
- HAND TOOLS / COMBINATION SET
- TOOL HOLDERS AND POUCHES / MAKPAC SYSTEM

- DRILLING / FIXING
- CONCRETE DRILLING / DEMOLITION
- MIXING / STIRRING
- CUTTING (CONCRETE / METAL)
- GRINDING
- SANDING / POLISHING
- SAWING
- MULTI-TOOL



- ROUTERS / PLANERS

- NAILERS / STAPLERS

- HEAT GUN / LASER

- CLEANING

- OPE

- JOBSITE TOOLS

- SPECIALTY TOOLS

- HAND TOOLS / COMBINATION SET

- TOOL HOLDERS AND POUCHES / MAKPAC SYSTEM

**MAX 40V XGT**

## TD002G

### Cordless Impact Driver

**One-touch 4-speed selector**  
Provides precise fastening control for a wide range of applications

**Efficient, Durable, Compact, Lightweight and Outstanding High Power 220 N-m, excellent in continuous heavy-duty work**

- Increased screw tightening speed
- 10 modes for various applications: Wood/Bolt (1, 2, 3) /T-Mode (1, 2) /Max / Hard /Medium / Soft mode
- New appearance design and new one-touch bit installation with reduced resistance
- Constant speed control maintains fastening torque by preventing the rotation speed reduction caused by decreased battery capacity

**Quick-change memory mode;** allows operator to rapidly change between two registered setting

<b>Capacity</b>	Machine screw: M4 - M8   Standard bolt: M5 - M16 High strength bolt: M5 - M14   Steel: 22 mm
<b>Hex Shank</b>	6.35 mm (1/4")
<b>No Load Speed (RPM)</b>	Max:0 - 3,700 / H:0 - 3,200 / M:0 - 2,100 / S:0 - 1,100 / Wood:0 - 1,800 / Bolt (1):0 - 2,700 / Bolt (2):0 - 3,700 / Bolt (3):0 - 3,700 / T (1):0 - 2,900 / T (2):0 - 3,700
<b>Impacts Per Minute (IPM)</b>	Max:0 - 4,600 / H:0 - 3,600 / M:0 - 2,600 / S:0 - 1,400 / Wood:0 - 4,600 / Bolt (2):0 - 4,600 / Bolt (3):0 - 4,600 / T (2) mode:0 - 2,600
<b>Max Fastening Torque</b>	Hard / Mid / Soft: 170 / 50 / 20 N-m
<b>Fastening Torque</b>	220 N-m
<b>Dimensions (L x W x H)</b>	119 x 86 x 247 mm
<b>Net weight</b>	1.0kg (without battery)

**AVAILABLE VARIANTS**

4.0Ah	"Z" VARIANT
<b>TD002G M2</b> INCLUDES 2 BATTERIES / 1 CHARGER / MAKPAC CONNECTOR CASE	<b>TD002G Z</b> TOOL ONLY (DOES NOT INCLUDE BATTERY / CHARGER / CARRYING CASE)

**MAX 40V XGT**

## TD001G

### Cordless Impact Driver

**One-touch 4-speed selector**  
Provides precise fastening control for a wide range of applications

**Efficient, Durable, Compact, Lightweight and Outstanding High Power 220 N-m, excellent in continuous heavy-duty work**

- 10 modes for various applications: Wood/Bolt (1, 2, 3) /T-Mode (1, 2) /Max / Hard /Medium / Soft mode
- New one-touch bit installation
- Constant speed control maintains fastening torque by preventing the rotation speed reduction caused by decreased battery capacity

**Quick-change memory mode;** allows operator to rapidly change between two registered setting

<b>Capacity</b>	Machine Screw: M4 - M8 (5/32" - 5/16") Standard Bolt: M5 - M16 (3/16" - 5/8") High Strength Bolt: M5 - M14 (3/16" - 9/16") Coarse thread: 22 - 125 mm (7/8" - 4-7/8")
<b>Hex Shank</b>	6.35 mm (1/4")
<b>No Load Speed (RPM)</b>	Max / Hard / Mid / Soft / Wood / Bolt (1) / Bolt (2) / Bolt (3) / T (1) / T (2) mode: - 3,700 / 3,200 / 2,100 / 1,100 / 1,800 / 2,500 / 3,700 / 3,700 / 2,400 / 3,700
<b>Impacts Per Minute (IPM)</b>	Max / Hard / Mid / Soft / Wood / Bolt (1) / Bolt (2) / Bolt (3) / T (2) mode: 0 - 4,400 / 3,600 / 2,600 / 1,100 / 4,400 / 4,400 / 4,400 / 2,600
<b>Max Fastening Torque</b>	220 Nm
<b>Fastening Torque</b>	Hard / Med / Soft: 170 / 50 / 20 N m
<b>Dimensions (L x W x H)</b>	120x86x250 mm
<b>Net weight</b>	1.0 kg (without battery)

**AVAILABLE VARIANTS**

4.0Ah	"Z" VARIANT
<b>TD001G M2</b> INCLUDES 2 BATTERIES / 1 CHARGER / MAKPAC CONNECTOR CASE	<b>TD001G Z</b> TOOL ONLY (DOES NOT INCLUDE BATTERY / CHARGER / CARRYING CASE)

**MAX 40V XGT**

## TD003G

### Cordless Impact Driver

**One-touch 4-speed selector**  
Provides precise fastening control for a wide range of applications

**Achieves a balance of effective fastening performance and cost-competitiveness**

- High power 40Vmax XGT Li-Ion battery reduces the current load on the controller, allowing for continuous heavy-duty operation
- Aluminum hammer case + Black bumper
- Impact power selection:
- 4 modes (Max/ Hard/ Med./ Soft for bolt)
- 1 T-mode (for thin metal only)

**Quick-change memory mode;** allows operator to rapidly change between two registered setting

<b>Capacity</b>	Machine Screw: M4 - M8 (5/32" - 5/16") Standard Bolt: M5 - M16 (3/16" - 5/8") High Strength Bolt: M5 - M14 (3/16" - 9/16") Coarse thread: 22 - 125 mm (7/8" - 4-7/8")
<b>Hex Shank</b>	6.35 mm (1/4")
<b>No Load Speed (RPM)</b>	Max / H / M / S: 0 - 3,700 / 3,200 / 2,100 / 1,100 T mode:0 - 2,400
<b>Impacts Per Minute (IPM)</b>	Max / H / M / S: 0 - 4,100 / 3,600 / 2,600 / 1,100
<b>Max Fastening Torque</b>	210 Nm
<b>Fastening Torque</b>	Hard / Med / Soft: 170 / 50 / 20 N m
<b>Dimensions (L x W x H)</b>	121 x 86 x 245 mm
<b>Net weight</b>	1.0 kg (without battery)

**AVAILABLE VARIANTS**

2.0Ah	"Z" VARIANT
<b>TD003G A2</b> INCLUDES 2 BATTERIES / 1 CHARGER / MAKPAC CONNECTOR CASE	<b>TD001G Z</b> TOOL ONLY (DOES NOT INCLUDE BATTERY / CHARGER / CARRYING CASE)



**DTD172** 18V | **LXT**

**Cordless Impact Driver**

**NEW**



**Ultra compact & Higher efficiency achieved by using BL motor**

- Tool head slimmer enables easier screwdriving in tight corners or confined spaces
- Electronic 4-stage impact power selection + 4x Assist Modes
- 4x Assist Mode Variations: Wood mode, T-mode for thick metal plate, T-mode for thin metal plate and Bolt Mode
- Quick mode switching function with memory function





<b>Machine screw :</b>	M4 - M8 (5/32" - 5/16")
<b>Standard bolt :</b>	M5 - M16 (3/16" - 5/8")
<b>High tensile bolt :</b>	M5 - M14 (3/16" - 9/16")
<b>Coarse thread (in length):</b>	22 - 125 mm (7/8" - 4-7/8")
<b>Hex Shank</b>	6.35 mm (1/4")
<b>Impacts Per Minute (ipm)</b>	Max / Hard / Mid / Soft / Wood / Bolt / T (1) / T (2) mode : 0 - 3,600 / 3,200 / 2,100 / 1,100 / 1,800 / 3,600 / 2,900 / 3,600
<b>No Load Speed (rpm)</b>	Max / Hard / Mid / Soft / Wood / Bolt / T (2) mode : 0 - 3,800 / 3,600 / 2,600 / 1,100 / 3,800 / 3,800 / 2,600
<b>Max tightening torque</b>	180 N·m
<b>Max fastening torque</b>	Hard / Mid / Soft: 170 / 50 / 20 N·m
<b>Dimensions (L x W x H)</b>	114 x 81 x 236 mm
<b>Net weight</b>	0.82 kg (without battery)

**Standard Equipments:** Belt Clip

AVAILABLE VARIANTS		
5.0Ah	3.0Ah	"Z" VARIANT
<b>DTD172 RTJ</b> INCLUDES 2 BATTERIES / 1 CHARGER / MAKPAC CONNECTOR CASE	<b>DTD172 RFJ</b> INCLUDES 2 BATTERIES / 1 CHARGER / MAKPAC CONNECTOR CASE	<b>DTD172 Z</b> TOOL ONLY (DOES NOT INCLUDE BATTERY / CHARGER OR CARRY CASE)

**DTP141** 18V | **LXT**

**Cordless Impact Driver (4 Mode)**

**More compact design achieved by using BL motor and electronic clutch mechanism.**

- 4 Operation modes and Teks screw mode selection.
- Electronic Clutch Mechanism provides expanded torque range.
- Easier mode selection and higher durability of the selection mechanism.



<b>Capacity</b>	Steel: 10mm, Wood: 21mm <b>Masonry:</b> 8mm
<b>Impacts per minute (ipm)</b>	<b>Impact-driver mode</b> (Hard/Medium/Soft): 0-3,200/0-2,400/0-1,200
	<b>Hammer drill mode</b> (Hi/Lo): 0-32,400/0-8,400
<b>No load speed (rpm)</b>	<b>Impact-driver mode</b> (Hard/Medium/Soft): 0-2,700/0-2,200/0-1,300
	<b>Drill mode</b> (Hi / Lo) : 0-2,700 / 0-700
	<b>Hammer drill mode</b> (Hi / Lo) : 0-2,700 / 0-700
	<b>Screwdriver mode</b> (Hi / Lo) : 0-1,100 / 0-300
<b>Max. fastening torque</b>	<b>Impact-driver mode:</b> 150N.m
	<b>Drill mode :</b> 22 / 13N.m
<b>Dimensions (L x W x H)</b>	171 x 79 x 250mm
<b>Net Weight</b>	1.1kg (without battery)

AVAILABLE VARIANTS	
3.0Ah	"Z" VARIANT
<b>DTP141 RFJ</b> INCLUDES 2 BATTERIES / 1 CHARGER / MAKPAC CONNECTOR CASE	<b>DTP141 Z</b> TOOL ONLY (DOES NOT INCLUDE BATTERY / CHARGER OR CARRY CASE)

**DTD153** 18V | **LXT**

**Cordless Impact Driver**



**Compact and lightweight design**

- High performance with newly developed Brushless DC motor.
- Aluminum hammer case creates the impression of rigidity of the machine
- Dual LED lights with preglow / afterglow functions illuminate the work area





<b>Machine screw :</b>	M4 - M8 (5/32" - 5/16")
<b>Standard bolt :</b>	M5 - M16 (3/16" - 5/8")
<b>High tensile bolt :</b>	M5 - M14 (3/16" - 9/16")
<b>Coarse thread (in length):</b>	22 - 125 mm (7/8" - 4-7/8")
<b>Hex Shank</b>	6.35 mm (1/4")
<b>No load speed (rpm)</b>	0 - 3,400
<b>Impacts per minute (ipm)</b>	0 - 3,600
<b>Max. fastening torque</b>	170 N·m
<b>Dimensions (L x W x H)</b>	126x79x238 mm
<b>Net Weight</b>	0.82 kg (without battery)

**Standard Equipments:** Belt Clip

AVAILABLE VARIANTS		
5.0Ah	3.0Ah	"Z" VARIANT
<b>DTD153 RTJ</b> INCLUDES 2 BATTERIES / 1 CHARGER / MAKPAC CONNECTOR CASE	<b>DTD153 RFJ</b> INCLUDES 2 BATTERIES / 1 CHARGER / MAKPAC CONNECTOR CASE	<b>DTD153 Z</b> TOOL ONLY (DOES NOT INCLUDE BATTERY / CHARGER / CARRY CASE)

**DTS141** 18V | **LXT**

**Cordless Oil-Pulse Driver**

**More compact and lightweight thanks to the newly-developed oil unit and brushless motor**

- Incredibly low noise operation thanks to the impact mechanism using oil unit instead of anvil and hammer.
- "T" mode: Tightening mode for self-drilling screw and bolts.
- With the cooling system for oil unit, capable of long continuous operation.
- Using newly-developed Oil Unit as an impact mechanism instead of anvil and hammer, operation noise has been greatly reduced compared with cordless impact driver



<b>Capacity</b>	Machine screw : M4 - M8 (5/32" - 5/16")
	Standard bolt : M5 - M8 (3/16" - 5/16")
	High strength bolt : M5 - M6 (3/16" - 1/4")
	Coarse thread (in length): 22 - 125mm (7/8" - 4-7/8")
<b>Impacts per minute (ipm)</b>	Hard :0-2,700 Medium :0-2,200 Soft :0-1,400
<b>No load speed (rpm)</b>	Hard :0-3,200 Medium :0-2,000 Soft :0-1,200
<b>Max fastening torque</b>	40N·m
<b>Dimensions (L x W x H)</b>	136x79x240mm
<b>Net weight</b>	0.82kg (without battery)

AVAILABLE VARIANTS		
5.0Ah	3.0Ah	"Z" VARIANT
<b>DTS141 RTJ</b> INCLUDES 2 BATTERIES / 1 CHARGER / MAKPAC CONNECTOR CASE	<b>DTS141 RFJ</b> INCLUDES 2 BATTERIES / 1 CHARGER / MAKPAC CONNECTOR CASE	<b>DTS141 Z</b> TOOL ONLY (DOES NOT INCLUDE BATTERY / CHARGER OR CARRY CASE)

**DRILLING / FIXING**

**CONCRETE DRILLING / DEMOLITION**

**MIXING / STIRRING**

**CUTTING (CONCRETE / METAL)**

**GRINDING**

**SANDING / POLISHING**

**SAWING**

**MULTI-TOOL**

**ROUTERS / PLANERS**

**NAILERS / STAPLERS**

**HEAT GUN / LASER**

**CLEANING**

**OPE**

**JOBSITE TOOLS**

**SPECIALTY TOOLS**

**HAND TOOLS / COMBINATION SET**

**TOOL HOLDERS AND POUCHES / MAKPAC SYSTEM**

DRILLING / FIXING
CONCRETE DRILLING / DEMOLITION
MIXING / STIRRING
CUTTING (CONCRETE / METAL)
GRINDING
SANDING / POLISHING
SAWING
MULTI-TOOL
ROUTERS / PLANERS
NAILERS / STAPLERS
HEAT GUN / LASER
CLEANING
OPE
JOBSITE TOOLS
SPECIALTY TOOLS
HAND TOOLS / COMBINATION SET
TOOL HOLDERS AND POUCHES / MAKPAC SYSTEM

**TD112D** 1/4" 12V MAX | **CXT**

**Cordless Impact Driver**



**High power in compact design**

- Enhanced impact mechanism achieved by enlarging the dia of spindle and anvil
- Anvil wobbling is minimized by using two ball bearings as a new anvil holder
- Auto-stop system; Indication lamp warns battery power reduction
- 2-mode operation: Hard mode / Soft mode for multiple applications
- A-mode feature helps eliminate "screw cam-out" and "cross threading" by driving at low speed until tightening begins



<b>Capacity</b>	High Strength Bolt: M5 - M12 Standard Bolt: M5 - M14
<b>Hex Shank</b>	6.35 mm (1/4")
<b>Center Height</b>	25 mm
<b>Impacts Per Minute (IPM)</b>	Hard / Soft: 0 - 3,900 / 0 - 3,300
<b>No Load Speed (RPM)</b>	Hard / Soft: 0 - 3,000 / 0 - 2,000
<b>Max Fastening Torque</b>	Hard / Soft: 135 / 80 N-m
<b>Dimensions (L x W x H)</b>	145 x 52 x 195 mm
<b>Net weight</b>	0.82 kg (without Battery)

**Standard Equipment:** Belt clip



**AVAILABLE VARIANTS**

**"Z" Version**

**TD112DN Z**  
TOOL ONLY  
(DOES NOT INCLUDE BATTERY / CHARGER OR CARRY CASE)

**TD111D** 1/4" 12V MAX | **CXT**

**Cordless Impact Driver**

**Equipped with brushless motor and impact power selection has High/Low also with A mode (Assist mode)**

- Best possible ergonomic handle for screwdriving applications
- Modified motor delivers higher maximum torque
- Battery protection circuit is activated on high battery temperature to protect the battery from damages due to overdischarge, high temperature or overload current.



<b>Capacity</b>	Machine Screw: M4 - M8 mm (5/32 - 5/16") Standard Bolt: M5 - M14 (3/16 - 9/16") High Strength Bolt: M5 - M12 (3/16 - 1/2") Coarse thread (in length): 22 - 90 mm (7/8 - 3-1/2")
<b>Hex Shank</b>	6.35 mm (1/4")
<b>No Load Speed (RPM)</b>	0 - 3,000 / 0 - 1,300
<b>Impacts Per Minute (IPM)</b>	0 - 3,900 / 0 - 1,600
<b>Max Fastening Torque</b>	135 N-m
<b>Dimensions (L x W x H)</b>	135 x 66 x 210 mm
<b>Net weight</b>	0.72kg (without Battery)

**Standard Equipment:** Belt clip



**AVAILABLE VARIANTS**

4.0Ah	2.0Ah	"Z" Version
<b>TD111D WME</b> INCLUDES 2 BATTERIES / 1 CHARGER / CARRYING CASE	<b>TD111D WAE</b> INCLUDES 2 BATTERIES / 1 CHARGER / CARRYING CASE	<b>TD111D Z</b> TOOL ONLY (DOES NOT INCLUDE BATTERY / CHARGER OR CARRY CASE)

DRILLING / FIXING
CONCRETE DRILLING / DEMOLITION
MIXING / STIRRING
CUTTING (CONCRETE / METAL)
GRINDING
SANDING / POLISHING
SAWING
MULTI-TOOL
ROUTERS / PLANERS
NAILERS / STAPLERS
HEAT GUN / LASER
CLEANING
OPE
JOBSITE TOOLS
SPECIALTY TOOLS
HAND TOOLS / COMBINATION SET
TOOL HOLDERS AND POUCHES / MAKPAC SYSTEM

**TD0101** 1/4" **AC**

**Impact Driver**

**Compact design for perfect handling.**

- Externally accessible carbon brush.
- No harm to the wrist when a screw is seated.
- Enables to drive screws even without pre-drilling pilot holes.





<b>Continuous rating Input</b>	230W
<b>Capacity</b>	Machine screw : M4 - M8 (5/32" - 5/16") Standard bolt : M5 - M14 (3/16" - 9/16") High tensile bolt : M5 - M10 (3/16" - 3/8") Coarse thread (in length): 22 - 90mm (7/8" - 3-1/2")
<b>Driving shank (Hex)</b>	6.35mm (1/4")
<b>Impacts per minute (ipm)</b>	0-3,200
<b>No load speed (rpm)</b>	0-3,600
<b>Max. fastening torque</b>	100N.m (885in.lbs)
<b>Dimensions (L x W x H)</b>	184 x 67 x 192mm (7-1/4" x 2-5/8" x 7-9/16")
<b>Net weight</b>	0.99kg (2.2lbs)
<b>Power supply cord</b>	2.5m (8.2ft)

**Standard Equipment:** Phillips bit.

**TL064D** 1/4" 12V MAX | **CXT**

**Cordless Angle Impact Driver**

**Compact & lightweight right angle impact driver for fastening and loosening in tight spaces**

- Variable speed for a range of applications from auto repair to cabinet installation
- Large conveniently located paddle switch for comfortable operation
- Over one foot of tool extension for extra reach into deep tight spaces



<b>Capacity</b>	Machine Screw: M4 - M8 (5/32" - 5/16") Standard Bolt: M4 - M12 (5/32" - 1/2") High Tensile Bolt: M4 - M8 (5/32" - 5/16") Coarse thread (in length): 22 - 75 mm (7/8" - 2-31/32")
<b>Hex Shank</b>	6.35 mm (1/4")
<b>No Load Speed (RPM)</b>	0 - 2,000
<b>Impacts Per Minute (IPM)</b>	0 - 3,000
<b>Max Fastening Torque</b>	60 N m
<b>Dimensions (L x W x H)</b>	361x66x86 mm
<b>Net weight</b>	1.6kg

**Standard Equipment:** Belt clip



**AVAILABLE VARIANTS**

**"Z" Version**

**TL064D Z**  
TOOL ONLY  
(DOES NOT INCLUDE BATTERY / CHARGER OR CARRY CASE)

**TD022DSJ** 1/4" **7.2V**

**Cordless Impact Driver (In-Line)**

**Compact and lightweight design with precision control and high fastening torque**

- Comfortable grip design operates in straight or pistol grip positions
- Can be also used as a hand driver
- Multi-function variable speed rotary switch allows operator to adjust driving speed and direction simultaneously for precise fastening applications
- Adjustable handle with enhanced hinge mechanism for operational versatility
- Electric brake for maximum productivity and increased operator safety
- Lock button prevents accidental startup



<b>Capacity</b>	Machine Screw: M3 - M8 (1/8" - 5/16") Standard Bolt: M3 - M8 (1/8" - 5/16") High Tensile Bolt: M3 - M6 (1/8" - 1/4") Coarse thread (in length): 22 - 45 mm (7/8" - 1-3/4")
<b>Hex Shank</b>	6.35 mm (1/4")
<b>No Load Speed (RPM)</b>	0 - 2,450
<b>Impacts Per Minute (IPM)</b>	0 - 3,000
<b>Max Fastening Torque</b>	25 N.m (220 in.lbs.)
<b>Dimensions (L x W x H)</b>	Straight Style: 282x42x52 mm Pistol Style: 227x42x142 mm
<b>Net weight</b>	0.52 kg

**Standard Equipment:** Holster, Bit set, 2pcs 7.2V 1.5Ah Batteries, Charger



- DRILLING / FIXING
- CONCRETE DRILLING / DEMOLITION
- MIXING / STIRRING
- CUTTING (CONCRETE / METAL)
- GRINDING
- SANDING / POLISHING
- SAWING
- MULTI-TOOL
- ROUTERS / PLANERS
- NAILERS / STAPLERS
- HEAT GUN / LASER
- CLEANING
- OPE
- JOBSITE TOOLS
- SPECIALTY TOOLS
- HAND TOOLS / COMBINATION SET
- TOOL HOLDERS AND POUCHES / MAKPAC SYSTEM

**Comparison Chart - Cordless Impact Driver**

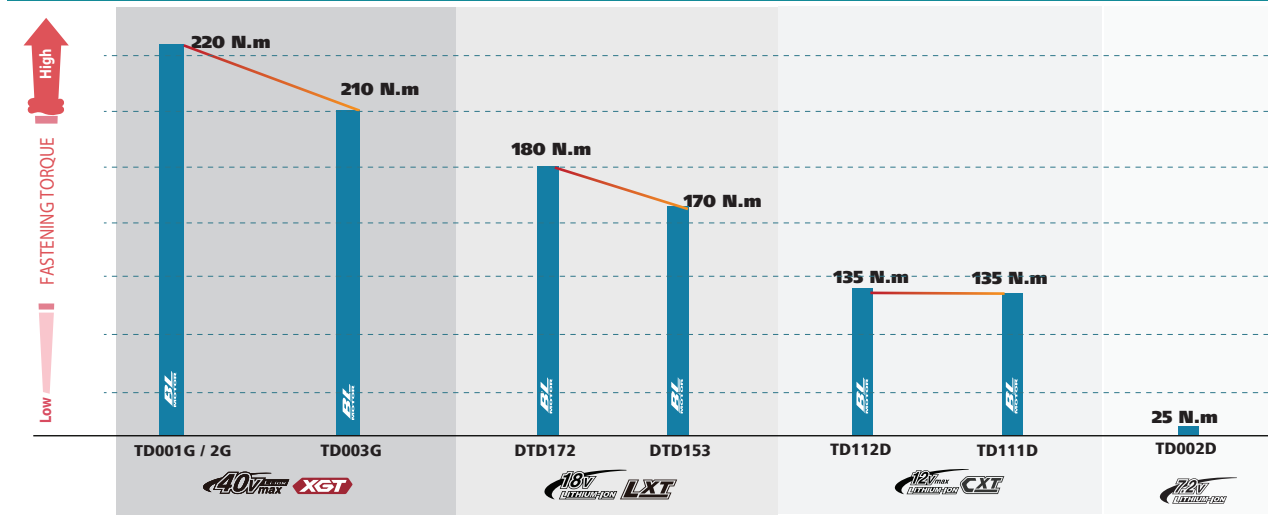

Model No.	No load speed (rpm)	Electronic Speed	Max. fastening torque (N.m)	Overall length (mm)	Net weight (kg)	BL motor
<b>Cordless Impact Driver</b>						
TD002G	0 - 3,700 / 3,200 / 2,100 / 1,100	4-Speed	220	119	1.0 kg	●
TD001G	0 - 3,700 / 3,200 / 2,100 / 1,100	4-Speed	220	120	1.0 kg	●
TD003G	0 - 3,700 / 3,200 / 2,100 / 1,100	4-Speed	210	121	1.0 kg	●
DTD172	0 - 3,600 / 3,200 / 2,100 / 1,100	4-Speed	180	114	0.82 kg	●
DTD153	0 - 3,400	-	170	126	0.82 kg	●
TD112D	0 - 3,000 / 0 - 2,000	2-Speed	135	145	0.82 kg	●
TD111D	0 - 3,000 / 1,300	2-Speed	135	135	0.72 kg	●
TD022D	0 - 2,450	-	25	227	0.52 kg	-
<b>Cordless 4 Mode Impact Driver</b>						
DTP141	0 - 2,700 / 2,200 / 1,300	3-Speed	150	171	1.1kg	●
<b>Cordless Oil-Pulse Driver</b>						
DTS141	0 - 3,200 / 2,000 / 1,200	3-Speed	40	136	0.82 kg	●

- DRILLING / FIXING
- CONCRETE DRILLING / DEMOLITION
- MIXING / STIRRING
- CUTTING (CONCRETE / METAL)
- GRINDING
- SANDING / POLISHING
- SAWING
- MULTI-TOOL

## Screwdrivers



- ROUTERS / PLANERS

- NAILERS / STAPLERS

- HEAT GUN / LASER

- CLEANING

- OPE

- JOBSITE TOOLS

- SPECIALTY TOOLS

- HAND TOOLS / COMBINATION SET

- TOOL HOLDERS AND POUCHES / MAKPAC SYSTEM

**DFS452**
18V | **LXT**

**Cordless Screwdriver**



**Ultra-high efficiency comparable to AC screwdrivers**

- Push Drive Technology - in lock-on mode the motor starts only when the fastener is engaged for a quieter work environment and to save battery power
- BL motor for better performance
- eXtreme Protection Technology (XPT) is engineered for improved dust and water resistance for operation in harsh conditions



<b>Capacity</b>	Self-Drilling Screw: 6 mm (1/4") Drywall Screw: 5 mm (3/16")
<b>Driving Shank (Hex)</b>	6.35 mm (1/4")
<b>No Load Speed (RPM)</b>	0 - 4,000
<b>Vibration Level</b>	Screwdriving w/o Impact: 2.5 m/s <sup>2</sup> or less
<b>Sound Pressure Level</b>	72 dB(A)
<b>Dimensions (L x W x H)</b>	251x79x259 mm (10"x3-1/8"x11-1/4")
<b>Net weight</b>	1.8 kg

**Standard Equipment:** 1 Phillips Bit + Magnetic connect Bit.

AVAILABLE VARIANTS		
5.0Ah	3.0Ah	"Z" VARIANT
<b>DFS452 RTJ</b> <small>INCLUDES 2 BATTERIES / 1 CHARGER / MAKPAC CONNECTOR CASE</small>	<b>DFS452 RFJ</b> <small>INCLUDES 2 BATTERIES / 1 CHARGER / MAKPAC CONNECTOR CASE</small>	<b>DFS452 Z</b> <small>TOOL ONLY (DOES NOT INCLUDE BATTERY / CHARGER OR CARRY CASE)</small>

**DFS250**
18V | **LXT**

**Cordless Screwdriver**



**Ultra-high efficiency comparable to AC screwdrivers**

- High torque ideal for decking applications
- Push Drive Technology - in lock-on mode the motor starts only when the fastener is engaged for a quieter work environment and to save battery power
- BL motor for better performance



<b>Capacity</b>	Coarse Thread: 4.5 x 90 mm (3/16" x 3-1/2") Drywall Screw: 5 mm (3/16") Self-Drilling Screw: 6 mm (1/4")
<b>Driving Shank (Hex)</b>	6.35 mm (1/4")
<b>No Load Speed (RPM)</b>	0 - 2,500
<b>Vibration Level</b>	Screwdriving w/o Impact: 2.5 m/s <sup>2</sup> or less
<b>Sound Pressure Level</b>	72 dB(A)
<b>Dimensions (L x W x H)</b>	259x79x259 mm
<b>Net weight</b>	1.9 kg

**Standard Equipment:** 1 Phillips Bit + Magnetic connect Bit.

AVAILABLE VARIANTS		
5.0Ah	3.0Ah	"Z" VARIANT
		<b>DFS250 Z</b> <small>TOOL ONLY (DOES NOT INCLUDE BATTERY / CHARGER OR CARRY CASE)</small>

**DF001DW**

**3.6V**

**3.6V In-Built Lithium-ion Cordless Screwdriver**



**Ultra-lightweight and compact Screwdriver**

- Convenient in a narrow space
- Operates in straight or pistol grip positions for comfortable operation
- Work amount is about 1.4 times as large as 6723DW
- Built-in LED job light with independent on/off switch
- On/off switch with forward and reverse modes
- Powered by a built-in rechargeable battery
- Includes Micro USB type AC adapter



<b>Fastening Capacities</b>	Wood Screw: ø3.8 x 32 mm
<b>No Load Speed (RPM)</b>	220
<b>Max Fastening Torque</b>	Hard / Soft: 4.0 / 3.0 N m
<b>Charging Time (hours)</b>	3 - 5
<b>Dimensions (L x W x H)</b>	Straight style: 287x47x51mm Pistol style: 205x47x51 mm
<b>Net weight</b>	0.36 kg

**Standard Equipment:** Bit set (81 pcs), Charger, USB Cable

**Includes 81pcs Bit Set**

- Magnetic bit:** 1pc
- Philips Bits:** PH1 - 5pcs, PH0 - 5pcs
- Philips:** PH1- 1pc, PH2 - 6pcs, PH3 - 3pcs
- Philips:** PH3 - 2Pcs,  
**Pozi:** P20 - 1pc, P21 - 2pcs, P22 - 2pcs, P23 x 1pc  
**Hex:** H2 - 2Pcs
- Hex:** H2.5 - 2Pcs, H3 - 2Pcs, H4 - 2Pcs, H5 - 2Pcs, H6 - 2Pcs
- Slotted:** 1.2x 6.5 - 2pcs  
**Square:** SQ0 - 1pc, SQ1 - 2pcs,  
SQ2 - 2pcs, SQ2 - 1pc
- Magnetic Nut Setter: 6pcs**  
10mm, 9mm, 8mm, 7mm, 6mm, 5mm  
**Philips 3pcs:** PH3, PH2, PH1  
**Slotted 3pcs:** 1.2X6.5, 0.8X5.5, 0.5X4.0
- Slotted:** 1.2x 6.5 - 2pcs  
**Square:** SQ0 - 1pc, SQ1 - 2pcs,  
SQ2 - 2pcs, SQ2 - 1pc
- Slotted 10pcs:**  
0.5x3 - 2pcs, 0.5x4 - 2pcs, 0.6x4.5 - 2pcs, 0.8x5.5 - 2pcs, 1.0x5.5 - 2pcs



**In-built Battery with Controller**

Part no: 620693-3

**USB Cable**

Part no: 661750-8

**AC Adapter ADP07 with micro USB Port**

Part no: 2pin - 198363-7

Part no: 3pin - 198369-5

Charging time: 3 to 5 hours



DRILLING / FIXING

CONCRETE DRILLING / DEMOLITION

MIXING / STIRRING

CUTTING (CONCRETE / METAL)

GRINDING

SANDING / POLISHING

SAWING

MULTI-TOOL

ROUTERS / PLANERS

NAILERS / STAPLERS

HEAT GUN / LASER

CLEANING

OPE

JBSITE TOOLS

SPECIALTY TOOLS

HAND TOOLS / COMBINATION SET

TOOL HOLDERS AND POUCHES / MAKPAC SYSTEM

**FS2500**



**Screwdriver**



**Best possible tool body for screwdriving.**

- Easy connect bit allows for quick bit change without using pliers.
- One touch locator, durable belt clip.
- A fully adjustable nose piece
- Can be used with self-drilling Tek screws
- Ideal for for roofing, façade, cladding and warehousing works



<b>Continuous rating Input</b>	570W
<b>Capacity</b>	Drywall screw : 5mm (3/16") Self drilling screw : 6mm (1/4")
<b>Max Fastening Torque</b>	29 N.m
<b>Driving shank (Hex)</b>	6.35mm (1/4")
<b>No load speed (rpm)</b>	0-2,500
<b>Dimensions (L x W x H)</b>	280 x 70 x 207mm (11" x 2-3/4" x 8-1/8")
<b>Net weight</b>	1.5kg (3.4lbs)
<b>Power supply cord</b>	2.5m (8.2ft)

**Standard Equipment:** Magnetic Socket Bit

**FS2700**



**Screwdriver**



**6 Stage torque adjustment for a wide range of applications.**

- Best possible tool body for screwdriving.
- Easy to bring pressure in line with center of driving bit axis.
- Bit holder is provided.
- LED job light convenient for operation in dark job sites.
- Durable belt clip.



<b>Continuous rating Input</b>	570W
<b>Capacity</b>	Hex screw : 6mm (1/4") Drywall screw : 6mm (1/4") Self drilling screw : 6mm (1/4")
<b>Max Fastening Torque</b>	Hard : 8-32 N.m
<b>Driving shank (Hex)</b>	6.35mm (1/4")
<b>No load speed (rpm)</b>	0-2,500
<b>Dimensions (L x W x H)</b>	301 x 70 x 207mm (11-7/8" x 2-3/4" x 8-1/8")
<b>Net weight</b>	1.8kg (4.0lbs)
<b>Power supply cord</b>	2.5m (8.2ft)

DRILLING / FIXING

CONCRETE DRILLING / DEMOLITION

MIXING / STIRRING

CUTTING (CONCRETE / METAL)

GRINDING

SANDING / POLISHING

SAWING

MULTI-TOOL

ROUTERS / PLANERS

NAILERS / STAPLERS

HEAT GUN / LASER

CLEANING

OPE

JOBSITE TOOLS

SPECIALTY TOOLS

HAND TOOLS / COMBINATION SET

TOOL HOLDERS AND POUCHES / MAKPAC SYSTEM





	FS4300	FS2300	FS6300
	Drywall Screwdriver		
<b>Continuous rating Input</b>	570W	570W	570W
<b>Capacity</b>	Drywall screw : 5mm (3/16") Self drilling screw : 6mm (1/4")	Drywall screw : 5mm (3/16") Self drilling screw : 6mm (1/4")	Drywall screw : 4mm (5/32")
<b>Max Fastening Torque</b>	Hard : 16Nm	Hard : 25Nm	Hard : 11N.m
<b>Driving shank (Hex)</b>	6.35mm (1/4")	6.35mm (1/4")	6.35mm (1/4")
<b>No load speed (rpm)</b>	0-4,000	0-2,500	0-6,000
<b>Dimensions (L x W x H)</b>	279 x 65 x 207mm (11" x 2-9/16" x 8-1/8")	290 x 70 x 207mm (11-3/8" x 2-3/4" x 8-1/8")	279 x 65 x 207mm (11" x 2-9/16" x 8-1/8")
<b>Net weight</b>	1.4kg (3.1lbs)	1.6kg (3.5lbs)	1.4kg (3.1lbs)
<b>Power supply cord</b>	2.5m (8.2ft)	2.5m (8.2ft)	2.5m (8.2ft)

**Silent clutch for quiet operation**

- Best possible tool body for screwdriving.
- Easy to bring pressure in line with center of driving bit axis.
- Bit holder and locator holder are provided.
- One touch locator, Durable belt clip.





**Standard Equipment:** Phillips Insert Bit (2pcs), Magnetic Bit Holder

6821
AC

**Drywall Screwdriver**



**Powerful Makita motor for high speed performance.**

- In-line design handle for maximum power thrust.
- Low noise level for quieter operation.
- Adjustable depth locator for consistent screw depth.
- Large variable speed trigger.



<b>Continuous rating input</b>	570 W
<b>Capacities</b>	Drywall screw : 5 mm (3/16") Self drilling screw : 6 mm (1/4")
	Driving Shank (Hex) : 6 mm (1/4")
<b>No load speed</b>	0 - 4,000 rpm
<b>Overall length</b>	273 mm (10-3/4")
<b>Net weight</b>	1.3 kg (2.9 lbs)
<b>Power supply cord</b>	2.0 m (6.6 ft.)

**Standard Equipment:** Phillips Insert Bit (2pcs), Magnetic Bit Holder

DFR551
18V | LXT

**Cordless Auto Feed Screwdriver**



**One-touch casing attachment/removal reduces the trouble of reversing and replacing a bit**

- Screw feeding mechanism redesigned to improve durability and reduce screw fall
- Ergonomically designed handle with soft grip.
- Push drive technology
- Reverse switch operable by one hand.



<b>Screw Strip</b>	4 x 25 - 55 mm
<b>Driving Shank (Hex)</b>	6.35 mm (1/4")
<b>No Load Speed (RPM)</b>	0 - 6,000
<b>Dimensions (L x W x H)</b>	396 x 88 x 165 - 211 mm
<b>Net weight</b>	1.5 kg (without battery)

**Standard Equipment:** Phillips Bit x3, Belt Clip,

AVAILABLE VARIANTS		
5.0Ah	3.0Ah	"Z" VARIANT
-	-	<b>DFR551 ZJ</b> TOOL + CARRY CASE ONLY (DOES NOT INCLUDE BATTERY / CHARGER)

**DFR550** 18V | **LXT**

**Cordless Auto Feed Screwdriver**



**More reliable sturdy aluminium casing attachment**

- Stopper base provides anti-tilt device for preventing screws from swaying.
- Silent clutch features high durability.
- Screw guide designed to prevent collated screw strip from getting tangled.
- Reverse switch operable by one hand.

**Capacity** Drywall screw : 4x25 - 55mm  
**Bit size** Hex Shank : 6.35mm (1/4")  
**No load speed (rpm)** 4,000  
**Dimensions (L x W x H)** 424x80x238mm  
**Net weight** 2.4kg (without battery)

**Standard Equipment:** Phillips bit.

AVAILABLE VARIANTS	
3.0Ah	"Z" VARIANT
<b>DFR550 RFE</b> INCLUDES 2 BATTERIES / 1 CHARGER / PLASTIC CASE	<b>DFR550 Z</b> TOOL ONLY (DOES NOT INCLUDE BATTERY / CHARGER OR CARRY CASE)

**6842** **Auto Feed Screwdriver**



**Drives screws quickly with very little effort.**

- Offers a more rigid aluminum casing with a stopper base.
- Anti tilt device to prevent the screws from swaying.
- More Reliable Casing Attachment.
- New Silent Clutch, ensures high operation efficiency with direct drive transmission in reverse rotation.

**Continuous rating Input** 470W  
**Capacity** Drywall screw : 4x25 - 55mm (5/32"x1" - 2-3/16")  
**Bit size** Hex Shank : 6.35mm (1/4")  
**No load speed (rpm)** 4,700  
**Dimensions (L x W x H)** 400x75x243mm (15-3/4"x2-15/16"x9-9/16")  
**Net weight** 2.0kg (4.4lbs)  
**Power supply cord** 2.5m (8.2ft)

**Standard Equipment:** Phillips bit, Belt clip, Thumb screw

**DRV150** 18V | **LXT**

**Cordless Rivet Gun**



**Cordless Li-ion Rivet Gun with Brushless Motor**

- Pulls rivets with diameters of 2.4mm, 3.2mm, 4.0mm and 4.8mm
- Fastens Ø4.8 - Ø2.4 Blind Rivets
- Transparent mandrel container catches mandrel's for easy disposal
- Maximum pulling force 10kN
- Rivet retaining mechanism holds rivet in the nose cone
- Compact center height for increased maneuverability against a wall



**Max pulling force** 10 kN  
**Length of Stroke** 25 mm (1")  
**Dimensions (L x W x H)** 310x80x287 mm  
**Net weight** 2.2 kg

**Standard Equipment:** Belt Clip

AVAILABLE VARIANTS	
5.0Ah	3.0Ah
<b>DRV150 RFJ</b> INCLUDES 2 BATTERIES / 1 CHARGER / MAKPAC CASE	<b>DRV150 ZJ</b> TOOL ONLY (WITH MAKPAC CASE) (DOES NOT INCLUDE BATTERY / CHARGER)

Rivet Size	Ø2.4 mm	Ø3.2 mm	Ø4.0 mm	Ø4.8 mm
Mandrel diameter: mm	Ø1.4 mm - 1.6 mm	Ø1.8 mm - 2.1 mm	Ø2.2 mm - 2.6 mm	Ø2.6 mm - 3.2 mm
Nose piece   Jaw pusher Size	Ø2.4 mm	Ø3.2 mm	Ø4.0 mm	Ø4.8 mm
Part No (with pipe)	<b>1911U6-3 ■</b>	<b>1911U4-7 ■</b>	<b>1911U1-3 ■</b>	<b>1911T9-0 ■</b>
Jaw (3pcs set) Size - Part No.	4.8 mm - <b>199731-7</b>			

Grease set (5g) Molybdenum disulfide grease 191D57-7



- DRILLING / FIXING
- CONCRETE DRILLING / DEMOLITION
- MIXING / STIRRING
- CUTTING (CONCRETE / METAL)
- GRINDING
- SANDING / POLISHING
- SAWING
- MULTI-TOOL
- ROUTERS / PLANERS
- NAILERS / STAPLERS
- HEAT GUN / LASER
- CLEANING
- OPE
- JOBSITE TOOLS
- SPECIALTY TOOLS
- HAND TOOLS / COMBINATION SET
- TOOL HOLDERS AND POUCHES / MAKPAC SYSTEM

DRILLING /  
FIXING

CONCRETE  
DRILLING /  
DEMOLITION

MIXING /  
STIRRING

CUTTING  
(CONCRETE /  
METAL)

GRINDING

SANDING /  
POLISHING

SAWING

MULTI-TOOL

ROUTERS /  
PLANERS

NAILERS /  
STAPLERS

HEAT GUN /  
LASER

CLEANING

OPE

JOBSITE  
TOOLS

SPECIALTY  
TOOLS

HAND TOOLS /  
COMBINATION SET

TOOL HOLDERS  
AND POUCHES /  
MAKPAC SYSTEM

## Impact Wrench



### TW001G 3/4"

40V MAX | XGT

#### Cordless Impact Wrench



#### Nut buster Impact Wrench with over 2030N.m Torque

- Reverse Rotation Auto Stop Mode stops after the bolt/nut loosened enough
- Single speed mode for reduced trigger-pulling force

#### Electronic 4 stage impact power selection

##### Full Speed Mode

Switches between variable and full speed by pressing the button. Reaches full speed with fewer pull trigger to minimize user's fatigue in continuous work

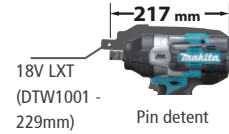

<b>Fastening Capacities</b>	Standard Bolt: M12 - M36 High Strength Bolt: M10 - M27
<b>Square Drive</b>	19 mm (3/4")
<b>No Load Speed (RPM)</b>	Max /H/M/S: 0 - 1,800 / 0 - 1,400 / 0 - 1,150 / 0 - 950
<b>Impacts Per Minute (IPM)</b>	Max /H/M/S: 0 - 2,500 / 0 - 2,400 / 0 - 2,200 / 0 - 1,900
<b>Max Fastening Torque</b>	1,800 Nm
<b>Dimensions (L x W x H)</b>	217x94x303 mm
<b>Net weight</b>	3.2 kg (without battery)

#### AVAILABLE VARIANTS

4.0Ah	"Z" VARIANT
<b>TW001G M2</b> INCLUDES 2 BATTERIES / 1 CHARGER / MAKPAC CONNECTOR CASE	<b>TW001G Z</b> TOOL ONLY (DOES NOT INCLUDE BATTERY / CHARGER / CARRYING CASE)

### TW008G 1/2"

40V MAX | XGT

#### Cordless Impact Wrench



#### Nut buster Impact Wrench with over 1,100N.m Torque

- Reverse Rotation Auto Stop Mode stops after the bolt/nut loosened enough
- Single speed mode for reduced trigger-pulling force

#### Electronic 4 stage impact power selection

##### Full Speed Mode

Switches between variable and full speed by pressing the button. Reaches full speed with fewer pull trigger to minimize user's fatigue in continuous work



<b>Fastening Capacities</b>	Standard Bolt: M10 - M24 High Strength Bolt (Grade 10.9): M10 - M16 High Strength Bolt (Grade F10T): M12, M16
<b>Square Drive</b>	12.7 mm (1/2")
<b>No Load Speed (RPM)</b>	Max / Hard / Mid / Soft: 0 - 2,900 / 2,700 / 1,900 / 1,200
<b>Impacts Per Minute (IPM)</b>	Max / Hard / Mid / Soft: 0 - 2,300 / 1,900 / 1,200 / 600
<b>Max Fastening Torque</b>	760 N.m
<b>Dimensions (L x W x H)</b>	170 x 86 x 291 mm
<b>Net weight</b>	2.0 kg (without battery)

#### AVAILABLE VARIANTS

4.0Ah	"Z" VARIANT
<b>TW008G M2</b> INCLUDES 2 BATTERIES / 1 CHARGER / MAKPAC CONNECTOR CASE	<b>TW008G Z</b> TOOL ONLY (DOES NOT INCLUDE BATTERY / CHARGER / CARRYING CASE)

### TW005G 1/2"

40V MAX | XGT

#### Cordless Impact Wrench



#### Nut buster Impact Wrench with over 630N.m Torque

- Reverse Rotation Auto Stop Mode stops after the bolt/nut loosened enough
- Single speed mode for reduced trigger-pulling force

#### Electronic 4 stage impact power selection

##### Full Speed Mode

Switches between variable and full speed by pressing the button. Reaches full speed with fewer pull trigger to minimize user's fatigue in continuous work



<b>Fastening Capacities</b>	Standard Bolt: M10 - M20 High Strength Bolt: M10 - M16
<b>Square Drive</b>	12.7 (1/2)
<b>No Load Speed (RPM)</b>	Max /H/M/S: 0 - 3,200 / 0 - 2,600 / 0 - 1,800 / 0 - 1,000
<b>Impacts Per Minute (IPM)</b>	Max /H/M/S: 0 - 4,000 / 0 - 3,400 / 0 - 2,600 / 0 - 1,800
<b>Max Fastening Torque</b>	350 Nm
<b>Dimensions (L x W x H)</b>	144x86x248 mm
<b>Net weight</b>	1.2 kg (without battery)



#### AVAILABLE VARIANTS

4.0Ah	"Z" VARIANT
<b>TW005G M2</b> INCLUDES 2 BATTERIES / 1 CHARGER / MAKPAC CONNECTOR CASE	<b>TW005G Z</b> TOOL ONLY (DOES NOT INCLUDE BATTERY / CHARGER / CARRYING CASE)



**DTW1001** 3/4" (19mm) 18V | **LXT**

**Cordless Impact Wrench**

**Excellent Performance as powerful as AC model with highly enhanced Brushless DC motor deliver 1,050N.m torque.**

- Twin LED job light with preglow and afterglow functions
- Hammer case securely fastened with four bolts
- Variable speed control by trigger
- Easy-to-operate, push button type F/R change switch
- Best possible ergonomic handle



<b>Fastening Capacities</b>	Standard Bolt: M12 - M30 (1/2" - 1-1/4") High Tensile Bolt: M10 - M24 (3/8" - 1")
<b>Square Drive</b>	19 mm (3/4")
<b>No Load Speed (RPM)</b>	Hard / Medium / Soft: 0 - 1,800 / 0 - 1,000 / 0 - 900
<b>Impacts Per Minute (IPM)</b>	Hard / Medium / Soft: 0 - 2,200 / 0 - 2,000 / 0 - 1,800
<b>Max Fastening Torque</b>	1,050 N m
<b>Dimensions (L x W x H)</b>	229x91x289 mm
<b>Net weight</b>	3.0 kg (without battery)

**AVAILABLE VARIANTS**

5.0Ah	"Z" VARIANT
<b>DTW1001 RTJ</b> INCLUDES 2 BATTERIES / 1 CHARGER / MAKPAC CONNECTOR CASE	<b>DTW1001 Z</b> TOOL ONLY (DOES NOT INCLUDE BATTERY / CHARGER OR CARRY CASE)

**DTW300** 1/2" (12.7mm) 18V | **LXT**

**Cordless Impact Wrench**



**High Performance with Brushless Motor**

- Features a forward and reverse automatic stop function, with 6 modes optimised for fastening applications
- A maximum tightening torque of 330 N.m
- Compact design with a short overall length of 144 mm
- Electronic 4 stage impact power selection



C ring



<b>Fastening Capacities</b>	Standard Bolt: M10 - M20 High Strength Bolt: M10 - M16
<b>Square Drive</b>	12.7 mm (1/2")
<b>No Load Speed (RPM)</b>	0 - 3,200 / 2,600 / 1,800 / 1,000
<b>Impacts Per Minute (IPM)</b>	0 - 4,000 / 3,400 / 2,600 / 1,800
<b>Max Fastening Torque</b>	330 N m
<b>Dimensions (L x W x H)</b>	144x81x246 mm
<b>Net weight</b>	1.1 kg (without battery)

**AVAILABLE VARIANTS**

5.0Ah	"Z" VARIANT
<b>DTW300 RTJ</b> INCLUDES 2 BATTERIES / 1 CHARGER / MAKPAC CONNECTOR CASE	<b>DTW300 Z</b> TOOL ONLY (DOES NOT INCLUDE BATTERY / CHARGER OR CARRY CASE)

**DTW701** 1/2" (12.7mm) 18V | **LXT**

**Cordless Impact Wrench**



**High Performance with Brushless Motor**

- Features a forward and reverse automatic stop function, with 6 modes optimised for fastening applications
- A maximum tightening torque of 700 N.m
- Compact design with a short overall length of 170 mm
- Electronic 4 stage impact power selection
- Unique rubber joint suppress vibration to battery terminals



Pin detent



<b>Fastening Capacities</b>	Standard Bolt: M10 - M24 High Tensile Bolt: M10 - M16
<b>Square Drive</b>	12.7 mm (1/2")
<b>No Load Speed (RPM)</b>	0 - 2,200 / 0-1,900 / 0-1,200 / 0-500
<b>Impacts Per Minute (IPM)</b>	0-2,700 / 0-2,400ipm / 0-1,700 / 0-1,000
<b>Max Fastening Torque</b>	700 N m
<b>Dimensions (L x W x H)</b>	170 X 81 X 276 mm
<b>Net weight</b>	2.0 kg (without battery)

**AVAILABLE VARIANTS**

5.0Ah	"Z" VARIANT
<b>DTW701 RTJ</b> INCLUDES 2 BATTERIES / 1 CHARGER / MAKPAC CONNECTOR CASE	<b>DTW701 Z</b> TOOL ONLY (DOES NOT INCLUDE BATTERY / CHARGER OR CARRY CASE)

**DTW181** 1/2" (12.7mm) 18V | **LXT**

**Cordless Impact Wrench**



**Ultra-compact and ergonomic design with Brushless motor**

- Reverse Rotation Auto Stop Mode Stops Rotation and Impact in 0.2 Seconds when Fastener Is Loosened Adequately to Prevent Bolt/Nut Get Lost
- A maximum tightening torque of 210 N.m
- Compact design with a short overall length of 151 mm
- Electronic 3 stage impact power selection.



<b>Capacity</b>	Standard bolt : M8 - M16 (5/16" - 5/8") High strength bolt : M16 - M12 (1/4" - 1/2") Square drive : 12.7mm (1/2")
<b>Impacts per minute (ipm)</b>	Hard: 0 - 3,600 / Soft: 0 - 2,000
<b>No load speed (rpm)</b>	Hard: 0 - 2,400 / Soft: 0 - 1,300
<b>Max fastening torque</b>	210N m
<b>Dimensions (L x W x H)</b>	151x79x235mm
<b>Net weight</b>	0.82 kg (without battery)

**AVAILABLE VARIANTS**

5.0Ah	"Z" VARIANT
<b>DTW181 RTJ</b> INCLUDES 2 BATTERIES / 1 CHARGER / MAKPAC CONNECTOR CASE	<b>DTW181 Z</b> TOOL ONLY (DOES NOT INCLUDE BATTERY / CHARGER OR CARRY CASE)

**DRILLING / FIXING**

**CONCRETE DRILLING / DEMOLITION**

**MIXING / STIRRING**

**CUTTING (CONCRETE / METAL)**

**GRINDING**

**SANDING / POLISHING**

**SAWING**

**MULTI-TOOL**

**ROUTERS / PLANERS**

**NAILERS / STAPLERS**

**HEAT GUN / LASER**

**CLEANING**

**OPE**

**JOBSITE TOOLS**

**SPECIALTY TOOLS**

**HAND TOOLS / COMBINATION SET**

**TOOL HOLDERS AND POUCHES / MAKPAC SYSTEM**

DRILLING / FIXING

CONCRETE DRILLING / DEMOLITION

MIXING / STIRRING

CUTTING (CONCRETE / METAL)

GRINDING

SANDING / POLISHING

SAWING

MULTI-TOOL

ROUTERS / PLANERS

NAILERS / STAPLERS

HEAT GUN / LASER

CLEANING

OPE

JOBSITE TOOLS

SPECIALTY TOOLS

HAND TOOLS / COMBINATION SET

TOOL HOLDERS AND POUCHES / MAKPAC SYSTEM

**TW161D** 1/2" 12V MAX | CXT

**Cordless Impact Wrench**



**Ultra compact design. High power impact wrench and Ideal for working in tight spaces and overhead applications**

- Brushless Motor delivers 165N-m Maximum fastening torque
- Reverse rotation auto-stop mode stops in 0.2 seconds after the bolt/nut loosened enough
- Aluminium hammer case creates the impression of rigidity of the machine
- Single LED job light with preglow and afterglow functions
- 2 stage impact power selection



<b>Fastening Capacities</b>	Standard Bolt: M8 - M16 High Tensile Bolt: M6 - M12
<b>Square Drive</b>	12.7 mm (1/2")
<b>No Load Speed (RPM)</b>	High / Low: 0 - 2,400 / 0 - 1,300
<b>Impacts Per Minute (IPM)</b>	High / Low: 0 - 3,600 / 0 - 2,000
<b>Max Fastening Torque</b>	165 N m
<b>Dimensions (L x W x H)</b>	150x66x232 mm
<b>Net weight</b>	0.82 kg (without battery)

**Standard Equipment:** Belt clip

AVAILABLE VARIANTS	
<b>4.0Ah</b>	<b>"Z" Version</b>
<b>TW161D SME</b> INCLUDES 2 BATTERIES / 1 FAST CHARGER / CARRYING CASE	<b>TW161D Z</b> TOOL ONLY (DOES NOT INCLUDE BATTERY / CHARGER OR CARRY CASE)

**TL065D** 12V MAX | CXT

**Cordless Angle Impact Wrench**



**Compact & lightweight right angle impact wrench for fastening and loosening in tight spaces**

- Variable speed for a range of applications from auto repair to product assembly
- Large conveniently located paddle switch for comfortable operation
- Over one foot of tool extension for extra reach into deep tight spaces



<b>Capacity</b>	Standard Bolt: M4 - M12 (5/32" - 1/2") High Tensile Bolt: M4 - M8 (5/32" - 5/16")
<b>Square Drive</b>	9.5 mm (3/8")
<b>No Load Speed (RPM)</b>	0 - 2,000
<b>Impacts Per Minute (IPM)</b>	0 - 3,000
<b>Max Fastening Torque</b>	60 N m
<b>Dimensions (L x W x H)</b>	361x66x86 mm
<b>Net weight</b>	1.6kg

**Standard Equipment:** Belt clip

AVAILABLE VARIANTS	
<b>"Z" Version</b>	
<b>TL065D Z</b> TOOL ONLY (DOES NOT INCLUDE BATTERY / CHARGER OR CARRY CASE)	

**DWR180** 9.5 / 6.35 mm (3/8 / 1/4") 18V | LXT

**Cordless Ratchet Wrench**



**800rpm producing up to 47.5Nm max fastening torque**

- Ability to tighten 13mm nut by removing socket adaptor
- Forward / reverse rotation change
- Compact design with a short overall length of 151 mm
- Ergonomic design and Ultra-lightweight at just 0.86kg skin
- Can be used as a hand ratchet wrench
- Supplied with two socket adapters



<b>Capacity</b>	Standard Bolt: M5 - M12 (3/16 - 1/2") High Strength Bolt: M5 - M10 (3/16 - 3/8")
<b>Square Drive</b>	9.5 / 6.35 mm (3/8 / 1/4")
<b>No Load Speed (RPM)</b>	0 - 800
<b>Max Fastening Torque</b>	47.5 N-m (420 in.lbs.)
<b>Flats Width</b>	13 mm (1/2")
<b>Angle Head Size</b>	Diameter: 31 mm (1-7/32")   Height: 25.5 mm (1")
<b>Dimensions (L x W x H)</b>	369 x 79 x 87 mm
<b>Net weight</b>	0.9 kg (without battery)

**Standard Equipment:** Socket Adapter 6.35mm & 9.5mm

AVAILABLE VARIANTS	
<b>3.0Ah</b>	<b>"Z" VARIANT</b>
<b>DWR180 RF</b> INCLUDES 1 BATTERY / 1 CHARGER / TOOL BAG	<b>DWR180 Z</b> TOOL ONLY (DOES NOT INCLUDE BATTERY / CHARGER / TOOL BAG OR CARRY CASE)

**WR100D** 12V MAX | CXT

**Cordless Ratchet Wrench**



**Compatible Socket adapters**

9.5 mm Part No.191A50-3    6.35 mm Part No.191A51-1



**Equipped with lock-pin style ratchet mechanism is employed, allowing for use as a pass-through ratchet wrench to tighten 13mm nut onto M8 threaded rod**

- Easy-to-grip small diameter grip for more comfort and control
- 47.5 N m of maximum torque and 0-800 RPM

**Forward / reverse rotation change**

Turn the reversing lever to the A side for clockwise rotation or to the B side for counterclockwise rotation

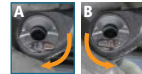

<b>Capacity</b>	Standard Bolt: M5 - M12 High Strength Bolt: M5 - M10
<b>Square Drive</b>	9.5 / 6.35 mm
<b>No Load Speed (RPM)</b>	0 - 800
<b>Max Fastening Torque</b>	47.5 N m
<b>Vibration Level</b>	2.5 m/s <sup>2</sup> or less
<b>Sound Pressure Level</b>	74 dB(A)
<b>Dimensions (L x W x H)</b>	341x67x84 mm
<b>Net weight</b>	1.2 kg

AVAILABLE VARIANTS	
<b>4.0Ah</b>	<b>"Z" Version</b>
<b>WR100D SM</b> INCLUDES 1 BATTERY / 1 CHARGER / TOOL BAG	<b>WR100D Z</b> TOOL ONLY (DOES NOT INCLUDE BATTERY / CHARGER OR CARRY CASE OR TOOL BAG)

**DWT310** 18Vx2 **LXT**

**Cordless Shear Wrench**

Max Fastening Torque  
Over  
**800N.m**



**High-speed fastening beyond AC tool**

- Fastens 380 M22 (7/8") torque shear bolts with two 18V 6.0 Ah batteries

Transport hook (optional)  
Shoulder belt (optional) (for carrying)



**36V LITHIUM ION LXT BLXPT MOTOR**

<b>Capacity</b>	Bolt : M16, M20, M22 (5/8", 3/4", 7/8")
<b>No Load Speed (RPM)</b>	14
<b>Max Fastening Torque</b>	804 N m (593 ft.lbs.)
<b>Vibration Level</b>	2.5 m/s <sup>2</sup> or less
<b>Sound Pressure Level</b>	83 dB(A)
<b>Sound Power Level</b>	94 dB(A)
<b>Dimensions (L x W x H)</b>	296x130x377 mm
<b>Net weight</b>	7.1 kg

**Standard Equipment:** Screwdriver

**AVAILABLE VARIANTS**

5.0Ah	"Z" VARIANT
<b>DWT310 PT2</b> INCLUDES 2 BATTERIES / 1 TWO PORT CHARGER AND CARRY CASE	<b>DWT310 ZK</b> TOOL ONLY (WITH CARRY CASE) (DOES NOT INCLUDE BATTERY / CHARGER)

**TW1000** 25.4mm (1") AC

**Impact Wrench**



**Robust high torque Impact Wrench for heavy-duty application.**

- Incredibly high torque 1,000N.m
- Rocker switch provides easy reversing.
- Rubber bumper for tool body protection.
- Features hanging hook for comfortable operation.



<b>Continuous rating Input</b>	1,200W
<b>Capacity</b>	Standard bolt: M24 - M30 (15/16" - 1-3/16") High tensile bolt: M22 - M24 (7/8" - 15/16") Square drive : 25.4mm (1")
<b>No load speed</b>	1,400rpm
<b>Max. fastening torque</b>	1,000N.m (738ft.lbs)
<b>Overall length</b>	382mm (15")
<b>Net weight</b>	8.6kg (19.9lbs)
<b>Power supply cord</b>	2.5m (8.2ft)

**Standard Equipment:** Socket 24-45, Grip

**6906** 19mm (3/4") AC

**Impact Wrench**



**Powerful torque of 588N.m(441ft.lbs) for super-duty applications.**

- Rocker type reversing switch for easy one handed forward or reverse operation.
- Slide handle adjusts 360degrees for operation convenience at any angle.
- Externally accessible carbon brushes for easy maintenance.



<b>Continuous rating Input</b>	115V / 220V 850W 230-240V 620W
<b>Capacity</b>	Standard bolt: M16 - M22 (5/8" - 7/8") High tensile bolt: M16 - M20 (5/8" - 3/4") Square drive : 19mm (3/4")
<b>Impacts per minute</b>	1,600ipm
<b>No load speed</b>	1,700rpm
<b>Max. fastening torque</b>	588N.m (441ft.lbs)
<b>Overall length</b>	327mm (12-7/8")
<b>Net weight</b>	5.6kg (12.3lbs)
<b>Power supply cord</b>	2.5m (8.2ft)

**Standard Equipment:** Grip Assembly, Socket.

**TW0350** 12.7mm (1/2") AC

**Impact Wrench**



**Incredibly high torque of 350N.m (260ft.lbs).**

- Rocker type switch for easy forward or reverse operation.
- Externally accessible carbon brushes for easy maintenance.



<b>Continuous rating Input</b>	400W
<b>Capacity</b>	Standard bolt : M12 - M22 (1/2" - 7/8") High tensile bolt : M12 - M16 (1/2" - 5/8") Square drive : 12.7mm (1/2")
<b>Impacts per minute</b>	2,000
<b>No load speed</b>	2,000
<b>Max. fastening torque</b>	350N m (260ft.lbs)
<b>Overall length</b>	282mm (11-1/8")
<b>Net weight</b>	3.0kg (6.6lbs)
<b>Power supply cord</b>	2.5m (8.2ft)

**Standard Equipment:** Socket.

- DRILLING / FIXING
- CONCRETE DRILLING / DEMOLITION
- MIXING / STIRRING
- CUTTING (CONCRETE / METAL)
- GRINDING
- SANDING / POLISHING
- SAWING
- MULTI-TOOL
- ROUTERS / PLANERS
- NAILERS / STAPLERS
- HEAT GUN / LASER
- CLEANING
- OPE
- JOB SITE TOOLS
- SPECIALTY TOOLS
- HAND TOOLS / COMBINATION SET
- TOOL HOLDERS AND POUCHES / MAKPAC SYSTEM

DRILLING / FIXING

CONCRETE DRILLING / DEMOLITION

MIXING / STIRRING

CUTTING (CONCRETE / METAL)

GRINDING

SANDING / POLISHING

SAWING

MULTI-TOOL

ROUTERS / PLANERS

NAILERS / STAPLERS

HEAT GUN / LASER

CLEANING

OPE

JOBSITE TOOLS

SPECIALTY TOOLS

HAND TOOLS / COMBINATION SET

TOOL HOLDERS AND POUCHES / MAKPAC SYSTEM

**6904VH** 12.7mm (1/2") 

**Impact Wrench**



**Versatile impact wrench for fastening nuts, bolts, and even lag screws.**

- 2 speed selection with variable speed in both ranges.
- Light weight design for comfort and control.
- Rugged housing with rubber bumper for long tool life.
- Optional bit adapter for driving wood bits.



<b>Continuous rating Input</b>	360W
<b>Capacity</b>	Standard bolt: M10 - M16 (3/8" - 5/8") High tensile bolt: M10 - M12 (3/8" - 1/2") Square drive : 12.7mm (1/2")
<b>Impacts per minute</b>	Hi : 0-3,000ipm / Lo : 0-2,500ipm
<b>No load speed</b>	Hi : 0-2,400rpm / Lo : 0-2,100rpm
<b>Max. fastening torque</b>	Hi : 196N.m (145ft.lbs) Lo : 147N.m (109ft.lbs)
<b>Overall length</b>	265mm (10-3/8")
<b>Net weight</b>	2.5kg (4.0lbs)

**Standard Equipment:** Sockets 3.

**6953** 12.7mm (1/2") 

**Impact Wrench**



**Compact body (overall length: 233mm) with palm-fitting soft grip for superior handling.**

- Removable belt clip can be attached on both sides of the tool.
- Externally accessible carbon brushes for easy maintenance.



<b>Continuous rating Input</b>	280W
<b>Capacity</b>	Standard bolt: M10 - M16 (3/8" - 5/8") High tensile bolt: M8 - M12 (5/16" - 1/2") Square drive : 12.7mm (1/2")
<b>Impacts per minute</b>	0-3,000ipm
<b>No load speed</b>	0-3,000rpm
<b>Max. fastening torque</b>	150N.m (110ft.lbs)
<b>Overall length</b>	233mm (9-1/8")
<b>Net weight</b>	1.5kg (3.3lbs)
<b>Power supply cord</b>	2.5m (8.2ft)

**Standard Equipment:** Does not come with sockets.

**Comparison Chart - Cordless Impact Wrench**

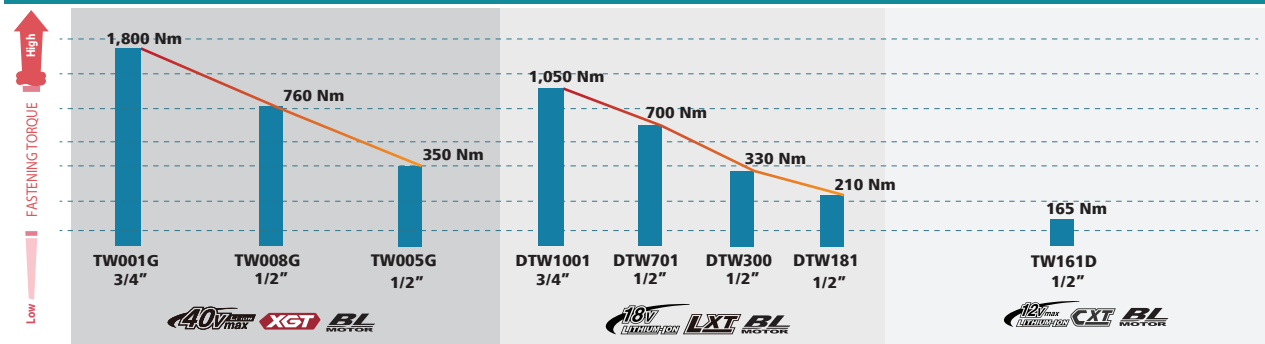

Model No.	Square drive	Max Fastening Torque (N-m)	No load speed (rpm)	Overall length (mm)	Net weight (kg)	BL motor
-----------	--------------	----------------------------	---------------------	---------------------	-----------------	----------

Cordless Impact Wrench						
TW001G	3/4" (19 mm)	1,800	0 - 1,800/ 1,400/ 1,150/ 950	217	3.2 kg	●
TW008G	1/2" (12.7mm)	760	0 - 2,300/ 1,900/ 1,200/ 600	170	2.0 kg	●
TW005G	1/2" (12.7mm)	350	0 - 3,200/ 2,600/ 1,800/ 1,000	144	1.2 kg	●
DTW1001	3/4" (19mm)	1,050	0-1,800/ 1,000/ 900	229	3.0 kg	●
DTW701	1/2" (12.7mm)	700	0 - 2,200/ 1,900/ 1,200/ 500	170	2.0 kg	●
DTW300	1/2" (12.7mm)	330	0 - 3,200/ 2,600/ 1,800/ 1,000	144	1.1 kg	●
DTW181	1/2" (12.7mm)	210	0-2,400/ 1,300	151	0.82 kg	●
TW161D	1/2" (12.7 mm)	165	0-2,400/ 1,300	150	0.82 kg	●

AC Impact Wrench						
TW1000	1" (25.4 mm)	1000	1,400	382	8.6 kg	-
6906	3/4" (19 mm)	588	1,700	327	5.6 kg	-
TW0350	1/2" (12.7 mm)	350	2,000	282	3.0 kg	-
6904VH	1/2" (12.7 mm)	196	Hi : 0-2,400 / Lo : 0-2,100rpm	265	2.5 kg	-
6953	1/2" (12.7 mm)	150	0-3000	233	1.5 kg	-

# Accessories - Drilling / Fixing

## Wood drill bits classification

### Wood drill bit



**Suitable for:** Drilling holes with small to medium diameter.

**Applications:** Soft plastics and general wood.

**Features:** Highly effective for boring more clean and precise holes than flat bit.



### Auger bit



**Suitable for:** Drilling of deep holes with medium to large diameter holes

**Applications:** Soft and hard wood.

**Features:** Threaded screw point push the bit into the work piece to providing a fast, easy to use and self feeding action. Highly effective for boring clean and precise holes compared to flat bit and wood drill bit.



### Flat bit



**Suitable for:** Drilling holes with medium to large diameters

**Applications:** Soft wood or soft plastic.

**Features:** Hexagon shank prevents chuck slipping. Grooved notch in head and outer cutting tips at the circumference of the hole



DRILLING / FIXING

CONCRETE DRILLING / DEMOLITION

MIXING / STIRRING

CUTTING (CONCRETE / METAL)

GRINDING

SANDING / POLISHING

SAWING

MULTI-TOOL

ROUTERS / PLANERS

NAILERS / STAPLERS

HEAT GUN / LASER

CLEANING

OPE

JOB SITE TOOLS

SPECIALTY TOOLS

HAND TOOLS / COMBINATION SET

TOOL HOLDERS AND POUCHES / MAKPAC SYSTEM

- DRILLING / FIXING
- CONCRETE DRILLING / DEMOLITION
- MIXING / STIRRING
- CUTTING (CONCRETE / METAL)
- GRINDING
- SANDING / POLISHING
- SAWING
- MULTI-TOOL
- ROUTERS / PLANERS
- NAILERS / STAPLERS
- HEAT GUN / LASER
- CLEANING
- OPE
- JOBSITE TOOLS
- SPECIALTY TOOLS
- HAND TOOLS / COMBINATION SET
- TOOL HOLDERS AND POUCHES / MAKPAC SYSTEM

## Standard 3 Point Wood Bit

- These bits are excellent when applied to soft to medium wood.
- They have a polished steel body with a centering point.



Bit Dia (D) (mm)	Overall Length (L1) (mm)	Working Length (L2)(mm)	Per Pkg	Part No
3	60	33	1	D-07026
4	75	43	1	D-07032
5	85	52	1	D-07048
6	95	57	1	D-07054
7	110	69	1	D-07060
8	115	75	1	D-07076
9	125	81	1	D-07082
10	135	87	1	D-07098
12	155	101	1	D-07107
14	170	108	1	D-07113
16	180	105	1	D-07129
18	200	120	1	D-07135
20	200	130	1	D-07141

## 5pcs Wood Drill bit in Boxed pack



Bit Dia (D) (mm)	Per Pkg	Part No
4, 5, 6, 8 & 10mm	1	D-72861

## Spade (Flat) Bit

- Contractor quality flat bits, suitable for soft woods.
- Diameters 6 - 36mm Hex shank for high torque application.
- Hexagon shank prevents chuck slippage. Grooved notch in head and outer cutting tips at the circumference of the hole



Bit Dia (D) (mm)	Overall Length (L1) (mm)	Per Pkg	Part No
6	150	1	D-07674
8	150	1	D-07680
10	150	1	D-07696
12	150	1	D-07705
14	150	1	D-07711
15	150	1	D-07727
16	150	1	D-07733
18	150	1	D-07749
20	150	1	D-07755
22	150	1	D-07761
24	150	1	D-07777
25	150	1	D-07783
26	160	1	D-07799
28	160	1	D-07808
30	160	1	D-07814
32	160	1	D-07820
34	160	1	D-07836
35	160	1	D-07842
36	160	1	D-07858

## Spade (Flat) Bit (1/4" shank)



Bit Dia (D) (mm)	Overall Length (L1) (mm)	Shank	Per Pkg	Part No
25	400	1/4"	1	■ E-17491

## 8pcs Flat Bit

For use with any 3 Jaw chuck, Maklok chuck and 1/4" Hex Drive Tools

With plastic case



Working Length (mm)	length (mm)	Size (mm)	Pc/ Pkg	Part No
120	150	12	1	P-52093
120	150	14	1	
120	150	16	1	
120	150	18	1	
120	150	20	1	
120	150	22	1	
120	150	25	1	
120	150	32	1	

- DRILLING / FIXING
- CONCRETE DRILLING / DEMOLITION
- MIXING / STIRRING
- CUTTING (CONCRETE / METAL)

## Extension Bar (1/4" shank)

Attached with flat bit for drilling deep narrow space. Can withhold 40mm maximum dia flat bit. Hold 1/4" Hex shank firmly



Overall Length (mm)	Shank	Per Pkg	Part No
300	1/4"	1	D-77213

- GRINDING
- SANDING / POLISHING
- SAWING

## Auger Bits

- Drilling of deep holes with medium to large holes.
- The bits comes in sizes 6mm to 30mm, self feeding and with a high cutting rate.

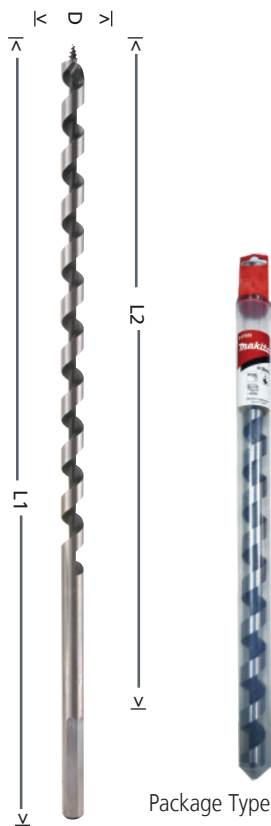

Bit Dia (D) (mm)	Overall Length (L1) (mm)	Working Length (L2)(mm)	Per Pkg	Part No
6	250	180	1	D-07331
8	250	180	1	D-07347
10	250	180	1	D-07353
12	250	180	1	D-07369
14	250	180	1	D-07375
16	250	180	1	D-07381
18	250	180	1	D-07397
20	250	180	1	D-07406
22	250	180	1	D-07412
24	250	180	1	D-07428

- MULTI-TOOL
- ROUTERS / PLANERS
- NAILERS / STAPLERS
- HEAT GUN / LASER

Bit Dia (D) (mm)	Overall Length (L1) (mm)	Working Length (L2)(mm)	Per Pkg	Part No
8	450	380	1	D-07559
10	450	380	1	D-07565
12	450	380	1	D-07571
14	450	380	1	D-07587
16	450	380	1	D-07593
18	450	380	1	D-07602
20	450	380	1	D-07618
22	450	380	1	D-07624
24	450	380	1	D-07630
26	450	380	1	D-07646
28	450	380	1	D-07652
30	450	380	1	D-07668

- CLEANING
- OPE
- JOBSITE TOOLS
- SPECIALTY TOOLS
- HAND TOOLS / COMBINATION SET
- TOOL HOLDERS AND POUCHES / MAKPAC SYSTEM

DRILLING /  
FIXING

CONCRETE  
DRILLING /  
DEMOLITION

MIXING /  
STIRRING

CUTTING  
(CONCRETE /  
METAL)

GRINDING

SANDING /  
POLISHING

SAWING

MULTI-TOOL

ROUTERS /  
PLANERS

NAILERS /  
STAPLERS

HEAT GUN /  
LASER

CLEANING

OPE

JOBSITE  
TOOLS

SPECIALTY  
TOOLS

HAND TOOLS /  
COMBINATION SET

TOOL HOLDERS  
AND POUCHES /  
MAKPAC SYSTEM

## 7 pcs. Self feeding bit set



- Suitable for drilling large diameter holes for pipe and conduit in wood.
- Threaded screw point pull the bit into the work piece providing a fast, easy to use self feeding action. Suitable for plumbing and electrical installation, etc.

Bit Dia / Type	Per Pkg	Part No
1"(25mm)	1	D-36005
1-1/4"(32mm)	1	
1-1/2"(38mm)	1	
2"(51mm)	1	
2-9/16"(65mm)	1	
3"(76mm)	1	
Extension bar 5-1/2"(140mm)	1	
Screw point 1-1/4" x 2"	3	
Screw point 3/8" x 2"-3/4"	1	
Hex wrench	2	
Replacement screw	2	

## Forstner bit 5pcs. set with wooden case

- Suitable for drilling of blind holes or penetrating holes of medium to large diameter with high quality. Suitable for precise working like a making furniture



Bit Dia	Per Pkg	Part No
15mm	1	D-47357 / D-47363 ■
20mm	1	
25mm	1	
30mm	1	
35mm	1	

## SDS-PLUS WOOD DRILL BIT



Adapted for  
SDS-PLUS Rotary Hammers

Can be used on SDS PLUS Hammers to drill wood without the need of having an additional chuck.



Bit Dia (mm)	Overall Length (mm)	Working Length (mm)	Per Pkg	Part No
4	105	43	1	B-57489
5	116	52	1	B-57495
6	123	57	1	B-57504
8	147	75	1	B-57510
10	163	87	1	B-57526

## Glass and Tiles Drill Bit

- 1/4" Hex shank
- Used in Rotary mode with almost any hammer drill and rotary drill
- Ideal for drilling holes in glass and tiles
- Gives a quick, clean and precise hole without cracks

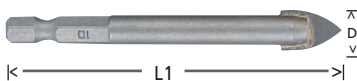

Bit Dia (D) (mm)	Overall Length L1 (mm)	Per Pkg	Part No
4	65	1	D-15942
5	65	1	D-15958
6	65	1	D-15964
8	70	1	D-15970
10	80	1	D-15986



# HSS metal drill bit series

Range

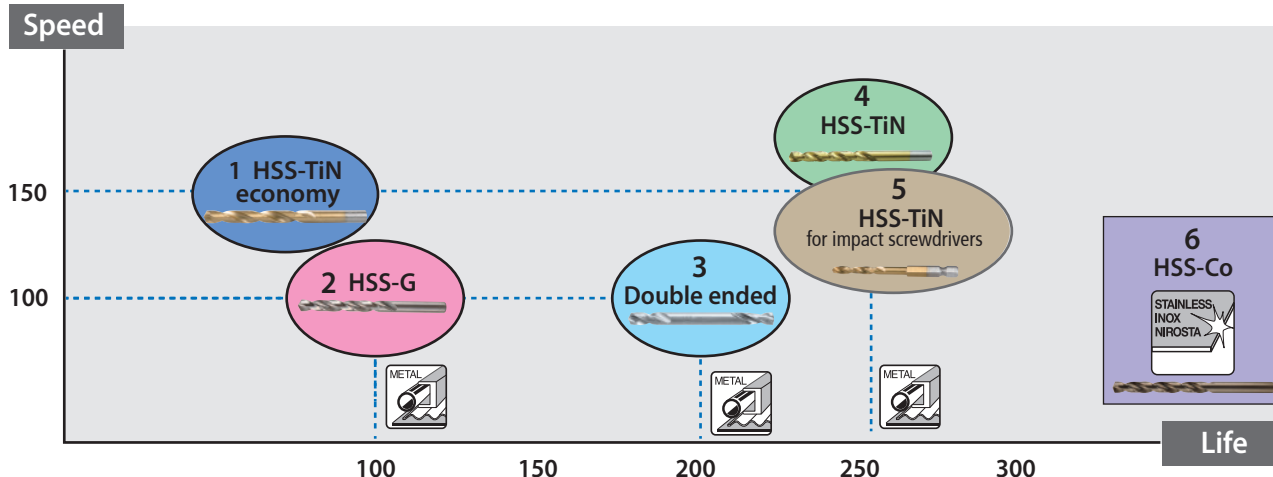

Description	2	2	3	4	5	6
Range	★★★★	★★★★	★★★★	★★★★★	★★★★★	Specialized
Description	HSS-TiN economy 	HSS-G 	Double ended 	HSS-TiN 	HSS-TiN impact screwdrivers 	HSS-Co5% 
Made of						
Process of manufacturing			Ground 			
Tip geometry	Split point 135° 	Chisel edge 118° 	Split point 135° 			Split point 135° 
Surface	TiN coating  Long life	Bright finish 		TiN coating  Long life		Amber finish (Rust resistant) 
Shank		Straight (Cylindrical) 		Straight (Cylindrical) Straight or 1/4"Hex 	Straight or 1/4"Hex 	Straight (Cylindrical) 

Ground:  
Drill bits ground from the block with excellent surface quality

135° split point:  
Ensure no walking and start fast, on contact

Material chart		1	2	3	4	5	6
Material	Wood	A	A	A	A	A	
	Plastic	AA	AA	AA	AA	AA	
	Non-ferrous metal	AA	AA	AA	AA	AA	A
	Sheet steel	AA	AA	AA	AA	AA	A
	Cast iron	AA	AA		AA	AA	AA
	Alloy steel	AA	AA		AA	AA	AA
	Stainless steel	A	A		A	A	AA

AA : Recommended  
A : Acceptable  
Non-ferrous metal (Such as Copper, Nickel and Zinc)

- DRILLING / FIXING
- CONCRETE DRILLING / DEMOLITION
- MIXING / STIRRING
- CUTTING (CONCRETE / METAL)
- GRINDING
- SANDING / POLISHING
- SAWING
- MULTI-TOOL
- ROUTERS / PLANERS
- NAILERS / STAPLERS
- HEAT GUN / LASER
- CLEANING
- OPE
- JOB SITE TOOLS
- SPECIALTY TOOLS
- HAND TOOLS / COMBINATION SET
- TOOL HOLDERS AND POUCHES / MAKPAC SYSTEM

DRILLING /  
FIXING

CONCRETE  
DRILLING /  
DEMOLITION

MIXING /  
STIRRING

CUTTING  
(CONCRETE /  
METAL)

GRINDING

SANDING /  
POLISHING

SAWING

MULTI-TOOL

ROUTERS /  
PLANERS

NAILERS /  
STAPLERS

HEAT GUN /  
LASER

CLEANING

OPE

JOBSITE  
TOOLS

SPECIALTY  
TOOLS

HAND TOOLS /  
COMBINATION SET

TOOL HOLDERS  
AND POUCHES /  
MAKPAC SYSTEM

## HSS-G metal drill bit

- Ground point drill bits suitable for ferrous and non-ferrous metals, offering good drilling speeds and extended working life.

**Note:-**

**Shank Type:** Straight (Cylindrical)  
**Available sizes:** 1.5mm - 8mm : 10pcs pack  
8.25mm - 13mm : 5pcs pack

**Shank Type:** Straight (Three flat)  
**Available sizes:** 14mm - 16mm : 1pc pack

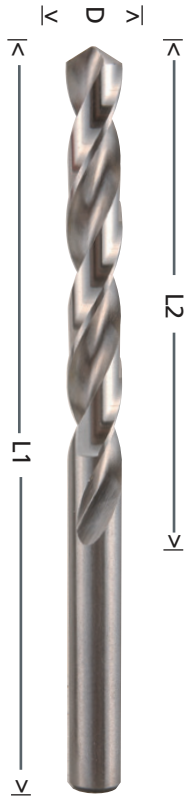

Bit Dia (mm)	Overall Length (L1) (mm)	Working Length (L2) (mm)	Per Pkg	Part No
1.50	40	18	10	D-06236
1.75	46	22	10	D-06242
2.0	49	24	10	D-06258
2.25	53	27	10	D-06264
2.50	57	30	10	D-06270
2.90	61	33	10	D-46648
3.0	61	33	10	D-06292
3.20	65	36	10	D-34942
3.25	65	36	10	D-06301
3.30	65	36	10	D-46567
3.50	70	39	10	D-06317
3.75	70	39	10	D-06323
4.0	75	43	10	D-06339
4.20	75	43	10	D-17762
4.25	75	43	10	D-06345
4.50	80	47	10	D-06351
5.0	86	52	10	D-06373
5.20	86	52	10	D-34986
5.25	86	52	10	D-06389
5.50	93	57	10	D-06395
6.0	93	57	10	D-06410
6.50	101	63	10	D-06432
6.80	109	69	10	D-46779
7.0	109	69	10	D-06454
7.50	109	69	10	D-06476
8.0	117	75	10	D-06498
8.50	117	75	5	D-06513
8.80	125	81	5	D-46785
9.0	125	81	5	D-06535
9.50	125	81	5	D-06557
10.0	133	87	5	D-06579
10.5	133	87	5	D-06591
11.0	142	94	5	D-06600
11.5	142	94	5	D-06616
12.0	151	101	5	D-06622
12.5	151	101	5	D-06638
13.0	151	101	5	D-06644
14.0	160	108	1	D-74893
15.0	169	114	1	D-74902
16.0	178	120	1	D-74918

## 6pcs HSS-G metal drill bit set



Bit Dia (mm)	Per Pkg	Part No
2, 3, 4, 5, 6, 8mm	Each size 1pc	D-75742

## 19 Pcs HSS-G metal drill bit set

- 1 pc each 1.0 to 10.0mm in steps of 0.5mmes)

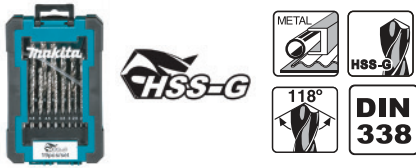

Bit Dia (mm)	Per Pkg	Part No
1, 1.5, 2, 2.5, 3, 3.5, 4, 4.5, 5, 5.5, 6, 6.5, 7, 7.5, 8, 8.5, 9, 9.5, 10	Each 1pc	D-67549

## (HSS-G) Double Ended Drill Bit

Double ended drill bits are derivative of HSS-G and both ends are drills

### Materials:

Same material as HSS-G and fully ground.

### Cutting edge:

135° split point geometry which ensures no walking and slipping. The total and working lengths are shorter than other HSS drill bits.

### Size:

Total 21 sizes from 2.0mm to 10.0mm including 3.1mm, 3.2mm, 3.3mm which are suitable sizes for drilling holes for rivets.

### Depth of hole:

30% shorter than HSS-G. Suitable for thin metal sheets because of the length.

### Package:

Each size 10 pieces a pack.

**Application:** While drilling many holes on thin metal sheets, double ended drill bits are preferred because of their short length and long life.

**Type of industry:** Sheet metal work, automotive body shop and maintenance jobs.



Double ended drill bits with angle drill makes very comfortable working at narrow spaces

Bit Dia (D) (mm)	Overall Length (L1) (mm)	Working Length (L2) (mm)	Per Pkg	Part No	New Part No (With country of origin)
2.0	38	7.5	10	B-26652	B-26864
3.0	46	10.6	10	B-26668	B-26870
3.1	49	11.0	10	B-26674	-
3.2	49	11.0	10	B-26680	-
3.3	49	11.0	10	B-26696	-
3.5	52	13.0	10	-	B-26917
3.8	55	14.0	10	B-26711	-
4.0	55	14.0	10	-	B-26939
4.1	55	14.0	10	B-26733	B-26945
4.2	55	14.0	10	-	-
4.3	55	14.0	10	B-26755	-
4.5	58	16.0	10	-	B-26973
4.8	62	17.0	10	B-26777	-
4.9	62	17.0	10	B-26783	-
5.0	62	17.0	10	B-26799	B-27006
5.1	62	17.0	10	B-26808	-
5.2	62	17.0	10	B-26814	-
5.5	66	19.0	10	B-26820	-
6.0	66	19.0	10	B-26836	B-27040
8.0	79	25.0	10	B-26842	-
10.0	89	25.0	10	B-26858	-



- DRILLING / FIXING
- CONCRETE DRILLING / DEMOLITION
- MIXING / STIRRING
- CUTTING (CONCRETE / METAL)
- GRINDING
- SANDING / POLISHING
- SAWING
- MULTI-TOOL
- ROUTERS / PLANERS
- NAILERS / STAPLERS
- HEAT GUN / LASER
- CLEANING
- OPE
- JBSITE TOOLS
- SPECIALTY TOOLS
- HAND TOOLS / COMBINATION SET
- TOOL HOLDERS AND POUCHES / MAKPAC SYSTEM

DRILLING /  
FIXING

CONCRETE  
DRILLING /  
DEMOLITION

MIXING /  
STIRRING

CUTTING  
(CONCRETE /  
METAL)

GRINDING

SANDING /  
POLISHING

SAWING

MULTI-TOOL

ROUTERS /  
PLANERS

NAILERS /  
STAPLERS

HEAT GUN /  
LASER

CLEANING

OPE

JOBSITE  
TOOLS

SPECIALTY  
TOOLS

HAND TOOLS /  
COMBINATION SET

TOOL HOLDERS  
AND POUCHES /  
MAKPAC SYSTEM

## HSS Co-Metal drill bit

- HSS drill bits with 5% cobalt content for easy drilling of high alloy or high tensile steels.
- Body ground for further accuracy and to reduce resistance.
- Use on mild, stainless and high alloy steels and difficult to machine materials, welded seams and car body work.
- Ideal for stainless steel and cast iron.

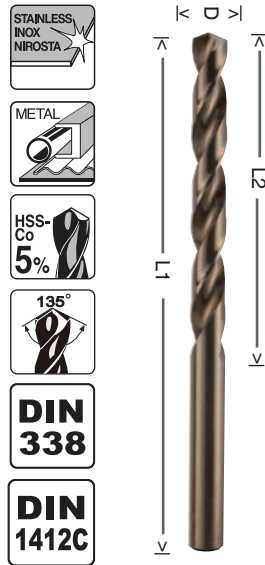

Bit Dia (D) (mm)	Overall Length (L1) (mm)	Working Length (L2) (mm)	Per Pkg	Part No
2.0	49	24	5	D-16623
2.5	57	30	5	D-16639
3.0	61	33	5	D-16645
3.5	70	39	5	D-16667
4.0	75	43	5	D-16673
4.5	80	47	5	D-16689
5.0	86	52	5	D-16695
5.5	93	57	5	D-16704
6.0	93	57	5	D-16710
6.5	101	63	5	D-16726
7.0	109	69	5	D-16732
7.5	109	69	5	D-16748
8.0	117	75	5	D-16754
8.5	117	75	5	D-16760
9.0	125	81	5	D-16776
9.5	125	81	5	D-16782
10.0	133	87	5	D-16798
10.5	133	87	5	D-16807
11.0	142	94	5	D-16813
11.5	142	94	5	D-16829
12.0	151	101	5	D-16835
12.5	151	101	5	D-16841
13.0	151	101	5	D-16857

## 6 Pcs HSS-Co metal drill set

Type: Straight (Cylindrical)



Bit Dia (mm)	Per Pkg	Part No
2 x 24mm 3 x 33mm 4 x 43mm 5 x 52mm 6 x 57mm 8 x 75mm	Each 1pc	D-57168 / D-75758

## HSS-Tin Metal Economy Drill Bits

- The bits surface is coated with Titanium Nitride which is extremely hard and highly wear-resistant, therefore enhances the quality and extends the life of the product.
- The Drill bit tip has a 135° split point geometry which ensures that there is no walking and slipping during operation.
- Available in various sizes from 2.0mm to 13mm and are sold at packs of 5 and 10 pcs.



Bit Dia (D) (mm)	Overall Length (L1) (mm)	Working Length (L2) (mm)	Per Pkg	Part No
2.0	49	24	10	D-64272
2.5	57	30	10	D-64288
3.0	61	33	10	D-64294
3.5	70	39	10	D-64303
4.0	75	43	10	D-64319
4.5	80	47	10	D-64325
5.0	86	52	10	D-64331
5.5	93	57	10	D-64347
6.0	93	57	10	D-64353
6.5	101	63	10	D-64369
7.0	109	69	10	D-64375
8.0	117	75	10	D-64397
8.5	117	75	5	D-64406
9.0	125	81	5	D-64412
9.5	125	81	5	D-64428
10.0	133	87	5	D-64434
10.5	133	87	5	D-64440
11.0	142	94	5	D-64456
12.0	151	101	5	D-64478
12.5	151	101	5	D-64484
13	151	101	5	D-64490

- DRILLING / FIXING
- CONCRETE DRILLING / DEMOLITION
- MIXING / STIRRING
- CUTTING (CONCRETE / METAL)
- GRINDING
- SANDING / POLISHING
- SAWING
- MULTI-TOOL
- ROUTERS / PLANERS
- NAILERS / STAPLERS
- HEAT GUN / LASER
- CLEANING
- OPE
- JOBSITE TOOLS
- SPECIALTY TOOLS
- HAND TOOLS / COMBINATION SET
- TOOL HOLDERS AND POUCHES / MAKPAC SYSTEM

## HSS-Tin Metal Economy Drill Bits in boxed pack



6pcs pack  
D-72833



10pcs pack  
D-72849



19pcs pack  
B-67795



19pcs pack x 10  
D-72229-10

Size (mm)	Pcs/Set	Part No
1pc each : 2, 3, 4, 5, 6 & 8mm	6pcs	D-72833
1pc each : 1, 2, 3, 4, 5, 6, 7, 8, 9 & 10mm	10pcs	D-72849
1.5 x 2, 2 x 2, 2.5 x 2, 3 x 2, 3.2, 3.5, 4, 4.5, 5, 5.5, 6, 6.5, 7, 8 & 10mm	19pcs	B-67795
1pc each: 1, 1.5, 2, 2.5, 3, 3.5, 4, 4.5, 5, 5.5, 6, 6.5, 7, 7.5, 8, 8.5, 9., 9.5, 10	19pcs x 10	D-72229-10

DRILLING /  
FIXING

## HSS-TiN Impact Drill Bit with 1/4" Hex. shank

CONCRETE  
DRILLING /  
DEMOLITION

- It is easy to mount and apply the 1/4 Hex Shank to the Impact Driver.
- It has a 135deg split point to avoid drill walking while drilling.
- Realized great durability applying TiN coating which is superior in heat and wear resistance.

MIXING /  
STIRRING

CUTTING  
(CONCRETE /  
METAL)



GRINDING

## HSS-TiN Metal Drill Bit For SDS-PLUS Hammers

SANDING /  
POLISHING

Fully ground HSS drill bit

 Adapted for  
SDS-PLUS Rotary Hammers

SAWING

Can be used on SDS PLUS Hammers to drill metal sheet without the need of having an additional chuck.

MULTI-TOOL



ROUTERS /  
PLANERS

## HSS Drill Bit - Titanium coated with Hex. shank

NAILERS /  
STAPLERS

For use with 3 Jaw & Maklok chucks and 1/4" Hex drive tools

HEAT GUN /  
LASER



CLEANING

OPE

JOBSITE  
TOOLS

SPECIALTY  
TOOLS

HAND TOOLS /  
COMBINATION SET

TOOL HOLDERS  
AND POUCHES /  
MAKPAC SYSTEM

Bit diameter (mm)	Length (mm)	Working length (mm)	Pc/ Pkg	Part No (WITH COUNTRY OF ORIGIN)
3	64	26	1	B-51085
3.5	70	29	1	B-51116
4	71	30	1	B-51122
6	80	37	1	B-51172
10	102	50	1	B-51247

Bit Dia (mm)	Overall Length (mm)	Working Length (mm)	Per Pkg	Part No
3	90	33	1	B-57401
3.5	100	39	1	B-57417
4	105	43	1	B-57423
4.5	110	47	1	B-57439
5	116	52	1	B-57445
6	123	57	1	B-57467

	Size (mm)	Pc/ Pkg	Part No
	1.5	1	P-51611
	2	1	P-51661
	3	1	P-51677
	3.2	1	P-51627
	5	1	P-51633

## Straight shank (Masonry drill bit)

- Straight shank tungsten carbide-tipped masonry drill bit



Bit Dia (D) (mm)	Overall Length (L1) (mm)	Working Length (L2)(mm)	Per Pkg	Part No	New Part No
3	60	30	1	D-05393	D-05228
4	70	35	1	D-05402	D-05234
5	85	45	1	D-05418	D-05240
6	100	60	1	D-05424	D-05256
6	150	90	1	D-05430	D-05262
7	100	55	1	D-05446	D-05278
7	150	90	1	D-05452	D-05284
8	110	60	1	D-05468	D-05290
8	150	90	1	D-05474	D-05309
9	150	90	1	D-05480	D-05315
10	150	90	1	D-05496	D-05321
11	150	90	1	D-05505	D-05337
12	150	90	1	D-05511	D-05343
13	150	85	1	D-05527	D-05359
14	150	85	1	D-05533	D-05365
15	150	85	1	-	D-05371
16	150	85	1	D-05555	D-05387

DRILLING / FIXING
CONCRETE DRILLING / DEMOLITION
MIXING / STIRRING
CUTTING (CONCRETE / METAL)
GRINDING
SANDING / POLISHING
SAWING
MULTI-TOOL

## Long straight shank (Masonry drill bit)

- Straight shank tungsten carbide-tipped masonry drill bit
- Ideal for application where deeper holes are required

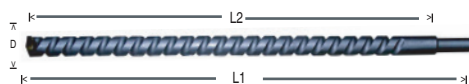

Bit Dia (D) (mm)	Overall Length (L1) (mm)	Working Length (L2)(mm)	Per Pkg	Part No
12	400	315	1	D-17697
12	600	505	1	D-17728
16	400	315	1	D-17706
16	600	505	1	D-17734
20	400	315	1	D-17712
20	600	505	1	D-17740

ROUTERS / PLANERS
NAILERS / STAPLERS
HEAT GUN / LASER

## 1pc Straight shank

For use with 3 Jaw & Maklok chucks and 1/4" Hex drive tools



Size (mm)	Overall Length (mm)	Working Length (mm)	Per Pkg	Part No
4	-	-	1	P-51758
5	-	-	1	P-51764
5.5	-	-	1	P-51770
6	-	-	1	P-51786
6.5	-	-	1	P-51792
7	-	-	1	P-51801
8	-	-	1	P-51817

CLEANING
OPE
JOB SITE TOOLS
SPECIALTY TOOLS

## 4 pcs straight shank (Masonry drill bit)



Bit Dia (mm)	Overall Length (mm)	Working Length (mm)	Per Pkg	Part No
5	85	-	1	P-10182
6	100	-	2	
8	120	-	1	

HAND TOOLS / COMBINATION SET
TOOL HOLDERS AND POUCHES / MAKPAC SYSTEM

DRILLING /  
FIXING

## 5 pcs straight shank (Masonry drill bit)



CONCRETE  
DRILLING /  
DEMOLITION

MIXING /  
STIRRING

CUTTING  
(CONCRETE /  
METAL)

GRINDING

SANDING /  
POLISHING

SAWING

MULTI-TOOL

ROUTERS /  
PLANERS

NAILERS /  
STAPLERS

HEAT GUN /  
LASER

CLEANING

OPE

JOBSITE  
TOOLS

SPECIALTY  
TOOLS

HAND TOOLS /  
COMBINATION SET

TOOL HOLDERS  
AND POUCHES /  
MAKPAC SYSTEM

Bit Dia (mm)	Overall Length (mm)	Working Length (mm)	Per Pkg	Part No
4	85	50	5	P-35520
5	85	50	5	P-35536
6	100	60	5	P-35242
8	120	-	5	P-35558
10	120	80	5	P-35564
12	150	-	5	P-35570

## 5 pcs straight shank (Masonry drill bit)



GRINDING

SANDING /  
POLISHING

## 5 pcs straight shank (Masonry drill bit)



SAWING

MULTI-TOOL

ROUTERS /  
PLANERS

Bit Dia (mm)	Overall Length (mm)	Working Length (mm)	Per Pkg	Part No
7	100	55	5	D-16508
8	110	60	5	D-16514

Type	length (mm)	Pc/ Pkg	Part No	New Part No
4	70	1	D-05175	D-72877
5	85	1		
6	100	1		
8	100	1		
10	100	1		

## 8 pcs straight shank (Masonry drill bit)



NAILERS /  
STAPLERS

HEAT GUN /  
LASER

CLEANING

Bit Dia (mm)	Overall Length (mm)	Working Length (mm)	Per Pkg	Part No
3	70	-	1	P-35514
4	85	-	1	
5	85	-	1	
6	100	-	1	
7	100	-	1	
8	120	-	1	
9	120	-	1	
10	120	-	1	

## 12 pcs straight shank (Masonry drill bit)



OPE

JOBSITE  
TOOLS

SPECIALTY  
TOOLS

HAND TOOLS /  
COMBINATION SET

TOOL HOLDERS  
AND POUCHES /  
MAKPAC SYSTEM

Size (mm)	Overall Length (mm)	Per Pkg	12pcs Part No
4	70	1	D-73483
5	85	1	
5.5	85	2	
6	100	2	
6.5	100	2	
7	100	2	
8	110	2	



## 12 pcs straight shank

(Masonry drill bit)



Size (mm)	Overall Length (mm)	Per Pkg	12pcs Part No
4	70	1	■ D-77126
5	85	2	
6	100	3	
8	110	3	
10	150	2	
12	150	1	

DRILLING / FIXING

CONCRETE DRILLING / DEMOLITION

MIXING / STIRRING

## 8 pcs straight shank

High efficient and durable

- The new head shape design and wider flute of the drill bits are designed for higher work efficiency and efficient dust removal while drilling.
- Improved carbide tip hardness and increased in abrasion resistance of the drill bits ensure the life of the bits much longer.

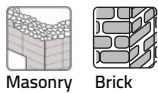

Masonry Brick

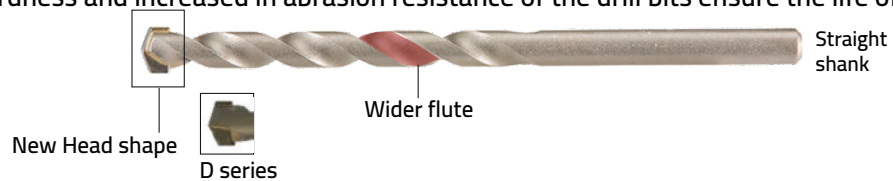

New Head shape

D series

Straight shank



Size (mm)	Overall Length (mm)	Per Pkg	Part No
3	60	1	■ E-15861
4	70	1	
5	85	1	
6	100	1	
6	150	1	
8	110	1	
8	150	1	
10	150	1	

CUTTING (CONCRETE / METAL)

GRINDING

SANDING / POLISHING

SAWING

MULTI-TOOL

ROUTERS / PLANERS

NAILERS / STAPLERS

## 8 pcs Multi material drill bits with straight shank

Drilling holes in a wide range of applications without changing drill bits

Drill holes in a wide range of applications such as brick, tile, wood, plastic, PVC, slate, limestone, aluminium and metal.



The sides and corners of the TCT carbide tip are sharply grounded. This ensure drilling holes in iron and other work materials.



Can be drilled by stacking multiple work materials at same time



Size (mm)	Overall Length (mm)	Per Pkg	Part No
3	70	1	■ E-15855
4	70	1	
5	85	1	
6	100	1	
6	150	1	
8	120	1	
8	150	1	
10	150	1	

HEAT GUN / LASER

CLEANING

OPE

JBSITE TOOLS

SPECIALTY TOOLS

HAND TOOLS / COMBINATION SET

TOOL HOLDERS AND POUCHES / MAKPAC SYSTEM



## BIM Hole saw (Standard range)

- Hole saws have 4/6 vari-pitch tooth design
- Recommended for cutting steel and cast iron pipe plates, aluminum copper and brass.



Size (mm)	Standard range
14	D-35368
16	D-16994
17	D-35374
19	D-17005
20	D-17251
21	D-35380
22	D-17011
24	D-17027
25	D-17033
27	D-35396
29	D-17267
30	D-35405
32	D-17049
33	D-35411
35	D-17055
37	D-35427
38	D-17061

Size (mm)	Standard range
40	D-17273
41	D-35433
43	D-35449
44	D-17077
46	D-35455
48	D-35461
51	D-17083
52	D-35477
56	D-35483
57	D-17099
59	D-35499
67	D-35508
68	D-17108
73	D-35514
76	D-17114
79	D-35520
83	D-17120

Size (mm)	Standard range
86	D-35536
89	D-35542
92	D-17136
95	D-35558
98	D-35564
102	D-35570
105	D-17142
108	D-35586
111	D-35592
114	D-35601
121	D-35617
127	D-17158
140	D-35623
152	D-17164

## Mandrel and pilot drill (for Hole saw)



Type	Fits Hole saws	Premium range Part no	Standard range Part no
<b>Mandrel with Pilot Drill</b>			
For 10mm Drill	14-29mm		D-17170
For 13mm Drill	32-152mm		D-17186
For SDS-PLUS	14-29mm		D-17603
For SDS-PLUS	32-76mm		D-17619

### Mandrel quick change system

For SDS-PLUS	32-210mm	P-35190	
--------------	----------	---------	--

### Pilot Drill

102mm long		P-35215	
71mm long	All		D-17192

## Hole saw (Assorted)

Six most common sizes for Plumber & Electrician. Comes in plastic carry case



Size (mm)	Part No.
19,22,29,38,44,57mm	D-47117
16,20,25,32,40,51mm	■ D-47123

■ : NEW PACKAGE

- DRILLING / FIXING
- CONCRETE DRILLING / DEMOLITION
- MIXING / STIRRING
- CUTTING (CONCRETE / METAL)
- GRINDING
- SANDING / POLISHING
- SAWING
- MULTI-TOOL
- ROUTERS / PLANERS
- NAILERS / STAPLERS
- HEAT GUN / LASER
- CLEANING
- OPE
- JOB SITE TOOLS
- SPECIALTY TOOLS
- HAND TOOLS / COMBINATION SET
- TOOL HOLDERS AND POUCHES / MAKPAC SYSTEM

DRILLING /  
FIXING

## BIM Hole saw for sheet metal (Premium range)

- Heavy duty
- Cutting capacity thickness for metal is 0.8-5mm and for stainless is 0.8-2mm
- Longer life due to Bi-Metal with 8% Cobalt

CONCRETE  
DRILLING /  
DEMOLITION

MIXING /  
STIRRING

CUTTING  
(CONCRETE /  
METAL)

The stopper absorbs the impact when hole saw goes through the materials



Its very easy to take out a piece of sheet metal due to ejector spring

High quality Bi-metal with 8% Cobalt

GRINDING

SANDING /  
POLISHING

SAWING

MULTI-TOOL

Size (mm)	Part no	Size (mm)	Part no	Size (mm)	Part no
16	B-29670	38	B-29804	76	B-36049
19	B-29692	40	B-29810	83	B-36061
20	B-29701	51	B-29854	89	B-36083
22	B-29723	60	B-29882	102	B-36099
25	B-29739	64	B-29898	127	B-36108
29	B-29751	65	B-35994	152	B-36114
32	B-29773	68	B-36011		
35	B-29795	70	B-36027		

ROUTERS /  
PLANERS

## Mandrel and pilot drill (For hole saw)

New Mandrel for  $\phi$  38-152mm Hole saw size



Adapter with O ring

NAILERS /  
STAPLERS

HEAT GUN /  
LASER

CLEANING

OPE

JOBSITE  
TOOLS

Type	Fits Hole saws	With Pilot drill	Part no
<b>Mandrel with Pilot Drill</b>			
For 10mm Drill	16-35mm	HSS6542	B-36120
For 13mm Drill	38-152mm	HSS6542	B-36136
<b>Pilot Drill</b>			
60mm long	All		B-36142

## Hole saw for sheet metal (Assorted)

Six most common sizes for Plumber & Electrician.



9.5/11mm Adapters with 1pcs of pilot drill

Size (mm)	Part No.
20,25,32,38,51,64mm	B-38679
19,22,29,38,44,57mm	B-38663

SPECIALTY  
TOOLS

HAND TOOLS /  
COMBINATION SET

TOOL HOLDERS  
AND POUCHES /  
MAKPAC SYSTEM

## How to use mandrel

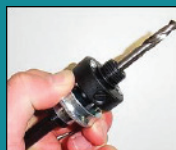

Pull down the silver part and hold it

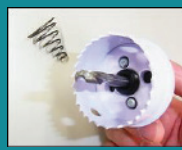

Adjust positions pins and put them into the hole saw



Fasten a hole saw to the adapter



Attach the spring

## Vacuum Brazed Diamond Hole Saw



- Can drill holes for various materials
- Thick wall and brick can be run through less efforts and less working time to drill holes

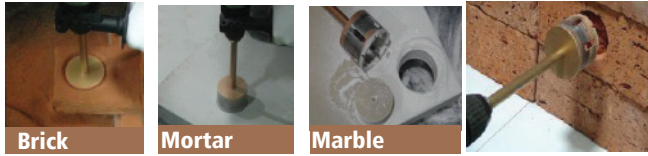

**For Machine:** 10 - 13mm Drill  
**Hole Saw:** Material of Tip: Diamond  
**Material of Body:** Carbon Steel  
**Centre Drill Bit:** Material fo Tip: Tungsten Carbide  
**Angle of Tip:** 135deg / Use by driver mode  
**Extension Rod:** 150mm Straight Shank for Hole Saw of all sizes  
**RPM:** 16mm-64mm, 3000-500rpm

Bit Dia (mm)	Working Length (mm)	Part no
16	40	B-45870
19	40	B-45886
25	40	B-45892
30	40	B-45901
32	40	B-45917
35	40	B-45923
38	40	B-45939
45	40	B-45945
50	40	B-45951
53	40	B-45967
57	40	B-45973
64	40	B-45989

DRILLING / FIXING
CONCRETE DRILLING / DEMOLITION
MIXING / STIRRING
CUTTING (CONCRETE / METAL)
GRINDING
SANDING / POLISHING
SAWING
MULTI-TOOL
ROUTERS / PLANERS
NAILERS / STAPLERS
HEAT GUN / LASER
CLEANING
OPE
JBSITE TOOLS
SPECIALTY TOOLS
HAND TOOLS / COMBINATION SET
TOOL HOLDERS AND POUCHES / MAKPAC SYSTEM

## Diamond wet Hole Saw For Hard Ceramics



- Suitable in wet drilling application
- Recommended to use with DC drills to work on hard ceramics with water
- Diamond Grit for faster cutting and longer life even on hard materials
- Easy centering on hard ceramic - These hole saws come with Spring-Loaded, Retractable Shaft pilot bit.



Retractable Starter Pilot Bit

Size (mm)	Part no
19	D-61210
20	D-61226
22	D-61232
25	D-61248
29	D-61254
32	D-61260
35	D-61276
38	D-61282
41	D-61298
44	D-61307
51	D-61313
54	D-61329
57	D-61335
60	D-61341
64	D-61357
65	D-61363
67	D-61379
68	D-61385
70	D-61391
76	D-61400
79	D-61416
83	D-61422
Adapter 9.5mm Hex (for 19-29mm Holesaw)	D-61438
Adapter 11mm Hex (for 32-83mm Holesaw)	D-61444
Retractable Starter Pilot Bit	D-61450

DRILLING /  
FIXING

CONCRETE  
DRILLING /  
DEMOLITION

MIXING /  
STIRRING

CUTTING  
(CONCRETE /  
METAL)

GRINDING

SANDING /  
POLISHING

SAWING

MULTI-TOOL

ROUTERS /  
PLANERS

NAILERS /  
STAPLERS

HEAT GUN /  
LASER

CLEANING

OPE

JOBSITE  
TOOLS

SPECIALTY  
TOOLS

HAND TOOLS /  
COMBINATION SET

TOOL HOLDERS  
AND POUCHES /  
MAKPAC SYSTEM

## Diamond Wet Core Cutters

**For Model:** DBM131/DBM230 (Diamond Core Drill)

**Material:** These can be used for soft, hard and reinforced concrete.

**Features:** Fast starting , Easy centering, Low friction and Time saving

**Connection thread:** 1 1/4" UNC

- Fast Starting
- Easy Centering
- Low Friction
- Time Saving



Core bit (Fitting)



Core bit



Outer Dia (mm)	Length (mm)	Part No.
32	420	P-65953
42	420	P-78330
52	420	P-78346
62	420	P-65969
65	420	P-78352
72	420	P-78368
78	420	P-78374
82	420	P-65975
92	420	P-78380
102	420	P-65981
107	420	P-78396
112	420	P-78405
122	420	P-65997
127	420	P-78411
132	420	P-66008
152	420	P-66014
162	420	P-66020
225	420	P-66042

## Accessories for Core Cutters

### Diamond core cutter - Steel Hex Extension Bar

Female 1 1/4" UNC to Male 1 1/4" UNC



For model	Length (mm)	Part No.
DBM131, DBM230	100mm	P-41604
	300mm	P-41626



DBM230 can be directly attached to cutter.

DBM131 can be connected to the cutter using Adapter M18 ( Part No. P-42151)



## Oil for Diamond Core Drill Machine

Oil for DBM230 (Diamond Core Drill)



		Part No.
1000ml	PE150	EE7100036

## Diamond Core Cutters

- To be used with the Drill Chuck System
- For Model: 8419B-2, 8420, HP2000, HP2010N, HP2050/F, HP2070
- Note: Use core cutters only with rotary mode.



Diameter (mm)	Effective Length (mm)	Part No.
22	300	P-25535
28	300	P-25541





## DRY Drilling Core cutters (PRB7 Slotted body)

- A: 13MM Drill Chucks - Used with P-34562 Adapter
- B: HR1830,HR2460, HR2470 - Used with P-30031 Adapter
- C: HR3000C - Used with P-30031 Adapter
- D: DBM131 - Used with P-49286 Adapter



For model	Diameter (mm)	Effective Length (mm)	Part No.
A, B, C, D	32	150	P-44731
A, B, C, D	48	150	P-25563
A, B, C, D	52	150	P-25579
D	152	150	P-25644

## Accessories for Dry Core Drills

Type / For model	Part No.
 1/2" BSP male For 13mm Chuck Adapter	P-34562
 SDS Plus chuck adaptor- R½ For models: HR1830, HR2460, HR2470, HR2432, HR3000C	P-30031
 Adaptor Pack- SDS Plus (Chuck Adapter, Guide Rod, Drift Key)	P-34730
 10mm Pilot Drill A Taper	P-34724

- DRILLING / FIXING
- CONCRETE DRILLING / DEMOLITION
- MIXING / STIRRING
- CUTTING (CONCRETE / METAL)
- GRINDING
- SANDING / POLISHING
- SAWING
- MULTI-TOOL
- ROUTERS / PLANERS
- NAILERS / STAPLERS
- HEAT GUN / LASER
- CLEANING
- OPE
- JOB SITE TOOLS
- SPECIALTY TOOLS
- HAND TOOLS / COMBINATION SET
- TOOL HOLDERS AND POUCHES / MAKPAC SYSTEM

**DRILLING / FIXING**

# Broach cutter for magnetic drilling machine

CONCRETE DRILLING / DEMOLITION

MIXING / STIRRING

CUTTING (CONCRETE / METAL)

GRINDING

SANDING / POLISHING

SAWING

MULTI-TOOL

ROUTERS / PLANERS

NAILERS / STAPLERS

HEAT GUN / LASER

CLEANING

OPE

JOBSITE TOOLS

SPECIALTY TOOLS

HAND TOOLS / COMBINATION SET

TOOL HOLDERS AND POUCHES / MAKPAC SYSTEM



Short = 25mm Depth		Long = 50mm Depth	
Diameter	Part No.	Diameter	Part No.
12mm Short	(MM)12S	12mm Long	(MM)12L
13mm Short	(MM)13S	13mm Long	(MM)13L
14mm Short	(MM)14S	14mm Long	(MM)14L
15mm Short	(MM)15S	15mm Long	(MM)15L
16mm Short	(MM)16S	16mm Long	(MM)16L
17mm Short	(MM)17S	17mm Long	(MM)17L
18mm Short	(MM)18S	18mm Long	(MM)18L
19mm Short	(MM)19S	19mm Long	(MM)19L
20mm Short	(MM)20S	20mm Long	(MM)20L
21mm Short	(MM)21S	21mm Long	(MM)21L
22mm Short	(MM)22S	22mm Long	(MM)22L
23mm Short	(MM)23S	23mm Long	(MM)23L
24mm Short	(MM)24S	24mm Long	(MM)24L
25mm Short	(MM)25S	25mm Long	(MM)25L
26mm Short	(MM)26S	26mm Long	(MM)26L
27mm Short	(MM)27S	27mm Long	(MM)27L
28mm Short	(MM)28S	28mm Long	(MM)28L
29mm Short	(MM)29S	29mm Long	(MM)29L
30mm Short	(MM)30S	30mm Long	(MM)30L
31mm Short	(MM)31S	31mm Long	(MM)31L
32mm Short	(MM)32S	32mm Long	(MM)32L
33mm Short	(MM)33S	33mm Long	(MM)33L
34mm Short	(MM)34S	34mm Long	(MM)34L
35mm Short	(MM)35S	35mm Long	(MM)35L
36mm Short	(MM)36S	36mm Long	(MM)36L
37mm Short	(MM)37S	37mm Long	(MM)37L
38mm Short	(MM)38S	38mm Long	(MM)38L
39mm Short	(MM)39S	39mm Long	(MM)39L
40mm Short	(MM)40S	40mm Long	(MM)40L
41mm Short	(MM)41S	41mm Long	(MM)41L
42mm Short	(MM)42S	42mm Long	(MM)42L
43mm Short	(MM)43S	43mm Long	(MM)43L
44mm Short	(MM)44S	44mm Long	(MM)44L
45mm Short	(MM)45S	45mm Long	(MM)45L
46mm Short	(MM)46S	46mm Long	(MM)46L
47mm Short	(MM)47S	47mm Long	(MM)47L
48mm Short	(MM)48S	48mm Long	(MM)48L
49mm Short	(MM)49S	49mm Long	(MM)49L
50mm Short	(MM)50S	50mm Long	(MM)50L

## Broach cutter pilot pin



Pilot pin small (mm)Pilot-S-25

Pilot Pin large (mm)Pilot-L-50

Pilot Pin	Part No.
25mm	(MM)PILOT S
50mm	(MM)PILOT L

## Chuck adapter for broach cutter



For use with	Part No.
For MM32 only	MMCHU03

## Cutting Oil (Electro Magnetic Drill Press)



	Part No.
500ml	MMOIL02



1 Litre Empty Container



### Diamond Drill Stand (DBM131)

This stand is used when drilling holes larger than 70mm. But it is advisable to use at all times to avoid core bit and machine damage. (For DBM131)

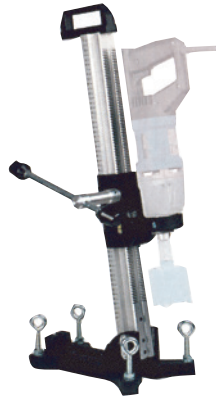

Description	Part No.
Diamond Drill Stand (For DBM131)	P-40082

### Type 43 Drill Stand

This stand is to be used for models with neck diameter 43mm



Description	Part No.
Type 43 Drill Stand	A-36712

### Diamond Drill Stand (DBM230)

This stand is to be used for All applications. (For DBM230)



Description	Part No.
Diamond Drill Stand (For DBM230)	P-54190

### Anchor Systems for Diamond Drill Stand

For DBM131 / DBM230

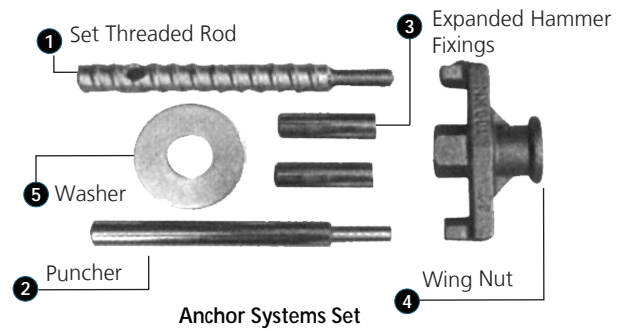

Description	Type	Part No.
Anchor System Set	Includes 1,2,3,4 and 5	P-40098

Drill a 15mm hole, fix the expanded hammer fixing, and set the threaded rod as shown below, place the stand then attach washer and nut (wing nut)

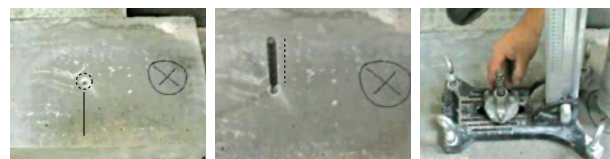

Expanded hammer fixing

Threaded rod

### Vise (For TB131)

This stand is to be used for model TB131

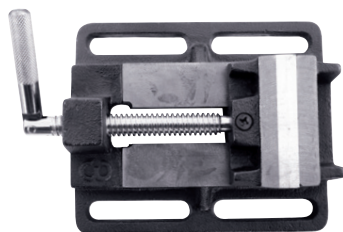

Description	Part No.
Vise (For TB131)	(TB)KK00000100

- DRILLING / FIXING
- CONCRETE DRILLING / DEMOLITION
- MIXING / STIRRING
- CUTTING (CONCRETE / METAL)
- GRINDING
- SANDING / POLISHING
- SAWING
- MULTI-TOOL
- ROUTERS / PLANERS
- NAILERS / STAPLERS
- HEAT GUN / LASER
- CLEANING
- OPE
- JOB SITE TOOLS
- SPECIALTY TOOLS
- HAND TOOLS / COMBINATION SET
- TOOL HOLDERS AND POUCHES / MAKPAC SYSTEM

## Drill chuck and chuck key



DRILLING /  
FIXING

CONCRETE  
DRILLING /  
DEMOLITION

MIXING /  
STIRRING

CUTTING  
(CONCRETE /  
METAL)

GRINDING

SANDING /  
POLISHING

SAWING

MULTI-TOOL

ROUTERS /  
PLANERS

NAILERS /  
STAPLERS

HEAT GUN /  
LASER

CLEANING

OPE

JOBSITE  
TOOLS

SPECIALTY  
TOOLS

HAND TOOLS /  
COMBINATION SET

TOOL HOLDERS  
AND POUCHES /  
MAKPAC SYSTEM

	For Model	Capacity (mm)	Thread size	Single Part #	Bulk Part #	Chuck Key
	DF0300, HP0300	1.0-10	1/2-20 UNF		766012-0	KEYLESS
	650, DP2010	6.5	3/8-24 UNF	192887-5		763418-3
	6010B, 6010BVR		3/8" - 24UNF	192970-8	763418-3	763418-3
	6408	0.8-10	3/8-24 UNF	192016-0		KEYLESS
	6413	0.8-10	3/8-24 UNF		763242-4	KEYLESS
	6300-4, 6305, DP4700, DS4011, 8419B 8419B 8416, 8420V, HP2000, HP2010N, HP20: HP2050, HP2070	2.0-13	1/2-20 UNF	192877-8		763432-9
	6300-4, 6301, 6305, DA4000LR, DP4700, DS4011, DS5000, 8416, HP2000 HP2010N, HP2070, NHP1300S, NHP1320S	4.5-16	1/2-20 UNF		763066-8	763432-9
	6016	16	(jacob staper No.3)		763011-3	763429-8
	DA3010, DDA350				763174-5	763415-9
	6408, DA392DW			192016-0		KEYLESS
	TB131				(TB)KK00000060	(TB)KK00000061
	HP1230	1.5-10	3/8" - 24UNF	192879-4		763415-9
	HP1631K			196193-0	766017-0	KEYLESS
	UT131D, HP1630K, HP1640K	1.5-13	1/2-20 UNF	196008-1	766016-2	763448-4
	DA4000LR, 6304LR			193318-7		763432-9
	DP4010, HP2050			193067-6		763448-4
	DA3000			193442-6		763414-1
	6080B			763003-2		KEYLESS
	DF001G, DDF481, DDF486, HP001G DHP481, DHP486 HP001G	1.5-13	1/2-20 UNF		763252-1	KEYLESS
	DDF481, DHP181	1.5-13	1/2-20 UNF		136405-9	KEYLESS
	DDF451, DHP451, DDF441, DHP441	1.5-13	1/2-20 UNF		763248-2	KEYLESS
	DDF453, DDF482, DDF484, DDF456, DD4F487, DF457D, DHP482, DHP484, DHP456, DHP459, HP457D, DF002G	1.5-13	1/2-20 UNF		763196-5 / 763191-5	KEYLESS
	DDF483, DHP483	1.5-13	1/2-20 UNF		766027-7	KEYLESS
	DA333D, DF330D, DF331D	1.5-13	1/2-20 UNF		763241-6	KEYLESS
	DA333D, DF330D, DF331D	0.8-10	3/8-24 UNF		763228-8	KEYLESS
	DF332D, DF333D, HP332D, HP333D	0.8-10	3/8-24 UNF		763238-5	KEYLESS
	DF347D	0.8-10	1/2-20 UNF		766002-3	KEYLESS
	HP330D, HP331D, HP347D	0.8-10	1/2-20 UNF		763229-6	KEYLESS
	DF488D, HP488D	1.5-13	1/2-20 UNF		763260-2	KEYLESS
	DA331D	0.8-10	3/8-24 UNF		766007-3	KEYLESS
	DDF487, DF002G, DHP482, DHP487 HP002G	1.5-13mm	1/2-20 UNF		763256-3	KEYLESS
	DA001G, DDA460, DG001G, DG460D	2.0-13	(Press fit)		763250-5	763251-3
	DDA450	2.0-13	1/2-20 UNF	193822-6	763183-4	763259-7
	DS5000	3.0-16	1/2-20 UNF		763254-7	763443-4
	DDF489, DHP489, DDF486, DHP486	1.5-13	1/2-20 UNF		763261-0	KEYLESS

## Locking Keyless Drill Chucks

Makita's unique chuck-lock system prevents the bit from slipping or being overtightened. Chuck snap out to unlock; in to lock.



For Models	Spindle Thread	Part No.
6301, 6013BR, 6300-4, 8416, 8419B, 8419B2, 8420V, DP4700, HP2000, HP2010N, HP2050N, HP2050/F, HP2070, NHP1300S, NHP1320S	3/8" - 24UNF	192282-9

- DRILLING / FIXING
- CONCRETE DRILLING / DEMOLITION
- MIXING / STIRRING
- CUTTING (CONCRETE / METAL)

## Angle Attachment

For drilling in close quarters, incorners, between joints and studs.

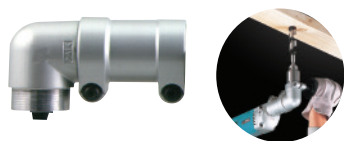

For Model	No Load Speed	Part No.
DS4011, 6013BR, 6300LR	High: 800rpm Low: 350rpm	STEX122177

- GRINDING
- SANDING / POLISHING
- SAWING

## Grip

For Model	Part No.
DBM131	EE7DE33695
UT2204	152892-4
6013BR / 6016 / 6300-4 / DA4000LR / DS4011 / DP4700	152492-0 151965-0
8419B2	273627-1
8419B	273479-0
8416 / 8420V / HP2000 / HP2010N	273627-1
8416 / 8420V / HP2000 / HP2010N	123018-5
NHP1300S / NHP1320S	152491-2
HP2050/F, HP2051/F, HP2070/F, HP2071/F, HP1640/F, HP1641/F, HP1630 HP1631, HP1230	153503-4
HP2010N, HP2000	122428-3
DF001G	127552-7
HP001G	127551-9
DDF481	126412-0
DHP481	126413-8
UT1305	152892-4
DDF486	■ 122C02-5
DHP486	■ 122D10-2
DF002G, HP002G, DDF484, DHP484	191E41-8
DDG460, DG001G (HANDLE SET)	191P11-3
DDF489	■ 1912A3-5
DHP489	■ 1912A4-3

- MULTI-TOOL
- ROUTERS / PLANERS
- NAILERS / STAPLERS
- HEAT GUN / LASER
- CLEANING
- OPE
- JOB SITE TOOLS
- SPECIALTY TOOLS
- HAND TOOLS / COMBINATION SET
- TOOL HOLDERS AND POUCHES / MAKPAC SYSTEM



## Wire brush for driver drills and impact drivers

Brass-coated wire with excellent waterproof feature and rust resistance  
The high-density crimped wire construction with brass-coated brushes allows for versatile applications on both metal and wood surfaces, even when working with water-containing wood



Brass coated steel wire for metal and wood

**1/4" Hex Shank**  
Compatible with Impact Drivers and Driver Drills  
Easy to mount with one click on impact driver

Brush	Shank	Type	Max rpm	Dia (mm)	Part #
Crimped / Brass Coated Steel Wire 0.3mm for Metal and Wood	1/4" Hex	<b>Cup Type</b> For flat surface 	4500	38	<b>D-76308</b>
			4500	50	<b>D-76314</b>
			4500	75	<b>D-76320</b>
		<b>Wheel type</b> For deep part, curved surface 	4500	38	<b>D-76336</b>
			4500	50	<b>D-76342</b>
			4500	75	<b>D-76358</b>
			4500	100	<b>D-76364</b>
			<b>End type</b> For inner surface, holes 	4500	12
		4500		19	<b>D-76386</b>
		4500		24	<b>D-76392</b>
		4500		28	<b>D-76401</b>

## Earth auger drill bits for driver drill and impact wrench

For Model	Shank type	Image	Bit dia. (mm)	Length (mm)	Working length (mm)	Part No.
<b>13mm Driver drill with side grip</b> 	Hex shank		30	600	200	<b>D-75415</b>
			45		200	<b>D-75421</b>
			70		200	<b>D-75437</b>
			100		240	<b>D-75443</b>
			130		280	<b>D-75459</b>
<b>3/4" Impact Wrench</b> 	3/4"		20	600	530	<b>B-54302</b>
			25			<b>B-54318</b>
			30			<b>B-54324</b>
			35			<b>B-54330</b>

## Impact black Screw Bit Series

Impact Black is the new range of High Durability screw bits for professional use

- Anti-rust treatment on the bit surface with high-class matte black appearance
- Makita logo on the screw bit makes it easy to distinguish



**IMPACT**  
Impact driver's accessory series  
**BLACK**



Black coating is designed to prevent rusting

Visible label

### Impact black screw bit (25pcs set)

- Bits comes in small flip top plastic case set which is convenient to carry and has good appearance.



Size	Length (mm)	Shank Type	Pcs/ pkg	Part No
PH2	25	NZ - C	25	E-12360
PZ2	25	NZ - C	25	E-12376
T20	25	NZ - C	25	E-12382
T25	25	NZ - C	25	E-12398
T30	25	NZ - C	25	E-12653
T40	25	NZ - C	25	E-12669

### Impact black screw bit (25pcs set x 12 in counter display box)

- 25pcs bits comes in small flip top plastic case set and packed in a counter display carton as 12pcs set



Size	Length (mm)	Shank Type	Pcs/ pkg	Part No
PH2	25	NZ - C	25 X 12	E-12360-12
PZ2	25	NZ - C	25 X 12	E-12376-12
T20	25	NZ - C	25 X 12	E-12382-12
T25	25	NZ - C	25 X 12	E-12398-12
T30	25	NZ - C	25 X 12	E-12653-12
T40	25	NZ - C	25 X 12	E-12669-12

### Impact black screw bit (10pcs set)

- Bits comes in small flip top plastic case set which is convenient to carry and has good appearance.



Size	Length (mm)	Shank Type	Pcs/ pkg	Part No
PH2	50	NZ - E	10	E-14211

### Impact Black Screw bits (10pcs set)

- Impact black screw bits set, consists of popular sizes in a compact pack and with key holder
- Luxurious appearance screw bits and bit holder with rust resistance



Size	Length (mm)	Shank Type	Pcs/ pkg	Part No
PH1	25	1/4" Hex	1	E-15849
PH2			3	
PH3			1	
T15			1	
T20			1	
T25			1	
T30			1	
Magnetic Bit Holder 60mm		1/4" Hex	1	

### Double Ended Impact Black Screw bits (10pcs set)

- Impact black double ended screw bits feature Phillips heads at both the ends offer twice service life than single-tip screw bits
- Luxurious appearance with rust resistance



Size	Length (mm)	Shank Type	Pcs/ pkg	Part No
PH2	65	1/4" Hex	10	E-15827
PH2	110	1/4" Hex	10	E-15833

DRILLING / FIXING

CONCRETE DRILLING / DEMOLITION

MIXING / STIRRING

CUTTING (CONCRETE / METAL)

GRINDING

SANDING / POLISHING

SAWING

MULTI-TOOL

ROUTERS / PLANERS

NAILERS / STAPLERS

HEAT GUN / LASER

CLEANING

OPE

JBSITE TOOLS

SPECIALTY TOOLS

HAND TOOLS / COMBINATION SET

TOOL HOLDERS AND POUCHES / MAKPAC SYSTEM

DRILLING /  
FIXING

CONCRETE  
DRILLING /  
DEMOLITION

MIXING /  
STIRRING

CUTTING  
(CONCRETE /  
METAL)

GRINDING

SANDING /  
POLISHING

SAWING

MULTI-TOOL

ROUTERS /  
PLANERS

NAILERS /  
STAPLERS

HEAT GUN /  
LASER

CLEANING

OPE

JOBSITE  
TOOLS

SPECIALTY  
TOOLS

HAND TOOLS /  
COMBINATION SET

TOOL HOLDERS  
AND POUCHES /  
MAKPAC SYSTEM

### Impact Black Screw bit (8pcs set)



Easy to choose the sizes with printed text



Key ring for holding



Comes in a blister pack

Rubber holder with excellent portability  
Compact and convenient for your carriage

Size	Length (mm)	Shank Type	Pcs/ pkg	Part No
PH1	25	1/4" Hex	1	■ E-14227
PH2			1	
PH3			1	
T15			1	
T20			1	
T25			1	
T30			1	
Magnetic Bit Holder 60mm	1/4" Hex	1		

### Impact Black Screw bit (10pcs set)



Compact and convenient for your carriage

New structure that can be open and closed with one touch



Comes in a blister pack

Size	Length (mm)	Shank Type	Pcs/ pkg	Part No
PH1	50	1/4" Hex	1	■ E-14233
PH2			1	
PH3			1	
T15			1	
T20			1	
T25			1	

### Impact Black Screw bit (35pcs set x 10 in cardboard box)

- 35pcs set comes in a plastic case which is sealed with clamshell and packed in a counter display carton as 10pcs set

Plastic Case



Clamshell



10pcs set in counter display box



### Impact Black Screw bit (33pcs set)



- 33pcs Impact black screw bits set, consists of popular sizes and comes with 1/4"Hex Socket adapter for tightening bolts and nuts.
- Luxurious appearance screw bits and bit holder with rust resistance
- The bit set set comes in a compact plastic case, which is convenient for your carriage and storage



1/4" Hex Socket





Bit Holder

Size	Shank Type	Part No
PH1, PH2x2, PH3 PZ1, PZ2X2, PZ3 SL0.5X3, SL0.8X4, SL0.8x5 SL1.2X6.5 T10, T15, T20X2, T25, T27, T30, T40 ST10, ST15, ST20, ST25 ST27, ST30, ST40 H3, H4, H5,H6 14"Hex Socket adapter Sleeve chunk bit holder	1/4" Hex	■ E-15687

Size	Length (mm)	Part No
1xPH1,3xPH2,1xPH3   1xPZ1,3xPZ2,1xPZ3   1xT15, 2xT20, 2xT25,1xT30	25	E-06638-10
1xPH1,2xPH2,1xPH3   1xPZ1,2xPZ2, 1xPZ3 1xT15,1xT20,2xT25,1x T30   1xSL0.8x5.5	50	
Magnetic bit holder Magnetic Nut setter: 6mm,8mm,10mm,13mm		

# Phillips bits

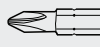
Wide variety of bit types for all screwdriving needs

Driver type   Shank type	1/4" Hex. Shank type			1/4" Hex. Shank type		NZ	1/4" Hex. Shank type		NZ
	 <b>Phillips (PH)</b>  <b>Slotted (SL)</b>	A	C-form		B	E-form (Single Ended)	 14mm	C	E-form (Double Ended)

# Phillips bits

	Driver	Size	Length (mm)	Shank Type	Per Pkg	Part No
	+	Ph 2	45	NZ - C	3	798308-1
	+	Ph 2	45	NZ - C, Hard	1	784229-3
	+	Ph 2	65	NZ - C	3	B-04787
	+	Ph 2	65	NZ - C	1	784203-1
	+	Ph 2	65	NZ - C, Hard	1	784230-8
	+	Ph 2	82	NZ - B	3	798336-6
	+	Ph 2	110	NZ - B	1	784234-0
	+	Ph 2	110	NZ - C	3	798337-4
	+	Ph 2	110	NZ - C	1	784206-5

- DRILLING / FIXING
- CONCRETE DRILLING / DEMOLITION
- MIXING / STIRRING
- CUTTING (CONCRETE / METAL)
- GRINDING
- SANDING / POLISHING
- SAWING
- MULTI-TOOL
- ROUTERS / PLANERS
- NAILERS / STAPLERS
- HEAT GUN / LASER
- CLEANING
- OPE
- JOBSITE TOOLS
- SPECIALTY TOOLS
- HAND TOOLS / COMBINATION SET
- TOOL HOLDERS AND POUCHES / MAKPAC SYSTEM

## Phillips bits

	Driver	Size	Length (mm)	Shank Type	Per Pkg	Part No	
DRILLING / FIXING		+	Ph 2	117	NZ - B for model 6834	5	A-12697
CONCRETE DRILLING / DEMOLITION		+	Ph 2	132	NZ - B for model 6835D	5	A-16536
MIXING / STIRRING		+	Ph 2	146	for model 6834	5	A-19825
CUTTING (CONCRETE / METAL)		+	Ph 2	150	NZ - C	3	798338-2
GRINDING		+	Ph 2	162	NZ - B for model 6842 DFR550	5	B-10481
SANDING / POLISHING		+	Ph 2	250	NZ - C	1	784221-9
SAWING		+	Ph 3	45	NZ - C	3	798310-4
MULTI-TOOL		+	Ph 3	50	NZ - C	10	P-06080
ROUTERS / PLANERS		+	Ph 3	65	NZ - C	3	798311-2
NAILERS / STAPLERS		-	Ph 3	110	NZ - C	3	798339-0
HEAT GUN / LASER		+ -	Ph 2 - SL 0.8	45	NZ - C	1	784614-0
CLEANING							
OPE							
JOBSITE TOOLS							
SPECIALTY TOOLS							
HAND TOOLS / COMBINATION SET							
TOOL HOLDERS AND POUCHES / MAKPAC SYSTEM							



## Phillips insert bits



	Drive	Size	Overall Length (mm)	Shank Type	Per Pkg	Part No
	+	PH 1	25	A	10	P-06030
					3	B-23450
	+	Ph 2	25	A	3	B-23466
	+	Ph 2	25	A	3	798398-4
	+	PH 3	25	A	3	798314-6

- DRILLING / FIXING
- CONCRETE DRILLING / DEMOLITION
- MIXING / STIRRING
- CUTTING (CONCRETE / METAL)
- GRINDING

## Slotted bits

• Wide variety of bit types for all screwdriving needs



	Drive	A(mm)	B(mm)	Length (mm)	Shank Type	Per Pkg	Part No
	⊖	0.6	5.0	45	NZ - B	3	798301-5
	⊖	1.2	8.0	45	NZ - B	3	798300-7
	⊖	1.2	10	52	NZ - B	3	798303-1
	⊖	1.2	10	70	NZ - B	3	798304-9

- SANDING / POLISHING
- SAWING
- MULTI-TOOL
- ROUTERS / PLANERS
- NAILERS / STAPLERS
- HEAT GUN / LASER

## Flexible shaft bit

- Flexible extension for screwing in confined, difficult to access corners.
- Application: Kitchens, Joinery, Drilling
- Suitable for carpenters, interior decoration suppliers, plumbers, electric equipment supplier and car maintenance suppliers.

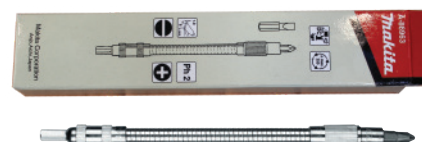

Length (mm)	Per Pkg	Part No
300mm	1	B-51867

- CLEANING
- OPE

## Hex Screw Bits

Screw bit 1/4"Hex Shank (NZ)

Wide range of lengths from the general total length of 50mm to 150mm that can be used in deep places.

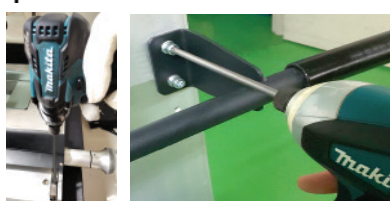
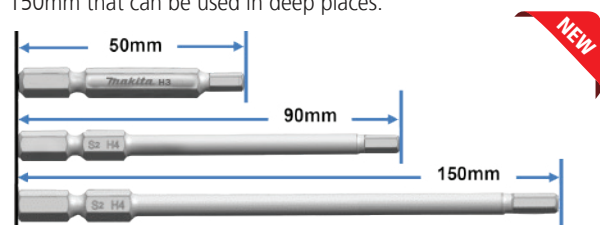

Size	Length (mm)	Shank Type	Pcs/pkg	Part No
H3	50	NZ - E	3	D-74930
H4	50	NZ - E	3	D-74946
H5	50	NZ - E	3	D-74952
H6	50	NZ - E	3	D-74968
H3	90	NZ - E	1	D-74974
H4	90	NZ - E	1	D-74980
H5	90	NZ - E	1	D-74996
H6	90	NZ - E	1	D-75007
H3	150	NZ - E	1	D-75013
H4	150	NZ - E	1	D-75029
H5	150	NZ - E	1	D-75035
H6	150	NZ - E	1	D-75041

- JOBSITE TOOLS
- SPECIALTY TOOLS
- HAND TOOLS / COMBINATION SET
- TOOL HOLDERS AND POUCHES / MAKPAC SYSTEM

DRILLING /  
FIXING

## Phillips Magnetic bit holder

(For insert bit)



CONCRETE  
DRILLING /  
DEMOLITION

MIXING /  
STIRRING

CUTTING  
(CONCRETE /  
METAL)

GRINDING

	TYPE	SIZE (MM)	LENGTH (MM)	FOR MODEL	PER PKG	PART NO
	Magnetic	6.35	60	6821	1	784811-8
	Magnetic	6.35	60	6821	1	P-05979
	Magnetic	6.35	75	6823, 6824, 6825	1	P-05985
	Magnetic	6.35	76	6823, 6824, 6825	1	784801-1
	Non-Magnetic	6.35	76	-	1	784604-3

SANDING /  
POLISHING

## Magnetic Nut Setter

B series : 50mm NZ type

SAWING

MULTI-TOOL



Type / Size	Part No
1x Magnetic Nut Setter      Size: 8mm X 50mm	B-38934
1x Magnetic Nut Setter      Size: 10mm X 50mm	B-38940
1x Magnetic Nut Setter      Size: 13mm X 50mm	B-38962
1x Magnetic Nut Setter      Size: 13mm	P-51736

ROUTERS /  
PLANERS

## Hex to Square Socket Adaptor

For use with 3 Jaw, Maklok chuck and 1/4" Hex drive tools

NAILERS /  
STAPLERS



Type / Size	Part No
1x Hex to Square Socket Adaptor      Size: 1/4" x 3/8"	P-51839

HEAT GUN /  
LASER

## 31pcs Screw Bit Set In Battery Shape Case

- Comes in Makita slide battery shaped case with a transparent cover and shield with clamshell pack.
- It is convenient for single hand opening because of one-touch button



• Note: Battery case can not be attached to makita power tools

## 10pcs Screw Bit Set in a Clamshell

- The Screwdriver Bit Set can be attached to your waist belt using the carabiner hook to avoid dropping and for safety in working in a high place.

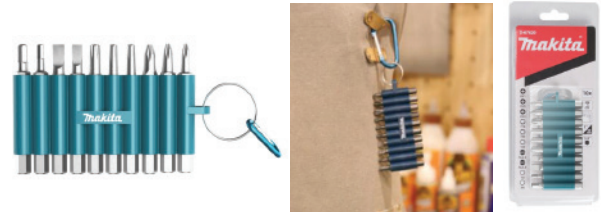

CLEANING

OPE

JOBSITE  
TOOLS

SPECIALTY  
TOOLS

HAND TOOLS /  
COMBINATION SET

TOOL HOLDERS  
AND POUCHES /  
MAKPAC SYSTEM

SHANK	SIZE	LENGTH	PART NO	SHANK	SHANK LENGTH	SIZE	PART NO
C-form	PH0, PH1, PH2x4, PH3, PZ0, PZ1, PZ2x4, PZ3, T10, T15, T20x2, T25x2, T27, T30, T40 HEX3, HEX4, HEX5, HEX6 SL 0.6X4.5, SL 0.8X5.5, SL 1.2X6.5	25mm	B-69901	1/4" Hex	50mm	PH0, PH1, PH2x4, PH3, PZ0, PZ1, PZ2x4, PZ3, T10, T15, T20x2, T25x2, T27, T30, T40 HEX3, HEX4, HEX5, HEX6 SL 0.6X4.5, SL 0.8X5.5, SL 1.2X6.5	D-67620
1/4" Hex	Bit holder	60mm					

## Torsion bits

### a) Double ended torsion bits      b) Double ended twist torsion bits

#### Advantages of Torsion bits

The high torque produced by impact drivers will damage standard screwdriver bits but the new Makita double ended torsion screwdriver bit out performs beyond all expectations, lasting up to 10 times longer than a standard bit.

- Torsion bits can last longer than a regular screw bit.
- Absorbs the shock on contact and prevents the bit from chipping and extends the life
- For continuous high torque fastening with impact drivers. and ideal for self-drilling metal screws and long wood screws

### a) Double ended torsion bits

- Can last up to 10x longer than a regular screw bit.



TYPE	SHAPE	LENGTH (MM)	FOR	PER PKG	PART NO
Magnetic	PH2	65	Impact drivers	3	B-55376

### b) Double ended twist torsion bits

- Can last up to 20x longer than a regular screw bit.
- The bottle has both magnetizing and demagnetizing function.



TYPE	SHAPE	LENGTH (MM)	FOR	PER PKG	PART NO
Magnetic	PH2	65	Impact drivers	10pcs of bit in each bottle.	B-63127

## Socket bit

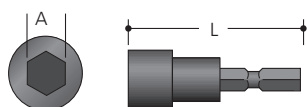

Type	Bolt Size	A(mm)	L(mm)	Shank Type	Per Pkg	Part No
Non-Magnetic	M3	5.5	55	NZ - B	1	784401-7
Non-Magnetic	M4	7.0	55	NZ - B	1	784402-5
Non-Magnetic	M5	8.0	55	NZ - B	1	784403-3
Non-Magnetic	M6	10	55	NZ - B	1	784405-9
Non-Magnetic	M5	8.0	65	MZ - B	1	784415-6
Magnetic	M6	10	65	MZ - B	1	784806-1
Non-Magnetic	M6	10	70	NZ - B	1	784406-7
Non-Magnetic	M8	12	86	NZ - B	1	784407-5
Non-Magnetic	M8	13	55	NZ - B	1	784408-3
Non-Magnetic	M8	14	55	NZ - B	1	784409-1
Non-Magnetic	M10	17	55	NZ - B	1	784416-4

Type	Bolt Size	A(inches)	L(mm)	Shank Type	Per Pkg	Part No
Magnetic	3/16"	5/16"	55	NZ - B	1	784808-7
Magnetic	3/16"	5/16"	65	MZ - B	1	784804-5
Magnetic	1/4"	3/8"	65	MZ - B	1	784802-9
For self drilling screw	1/4"	3/8"	55	NZ - B	1	784404-1
Magnetic	1/4"	3/8"	55	NZ - B	1	784809-5
Magnetic	1/2"	7/16"	65	MZ - B	1	784805-3

DRILLING / FIXING

CONCRETE DRILLING / DEMOLITION

MIXING / STIRRING

CUTTING (CONCRETE / METAL)

GRINDING

SANDING / POLISHING

SAWING

MULTI-TOOL

ROUTERS / PLANERS

NAILERS / STAPLERS

HEAT GUN / LASER

CLEANING

OPE

JOBSITE TOOLS

SPECIALTY TOOLS

HAND TOOLS / COMBINATION SET

TOOL HOLDERS AND POUCHES / MAKPAC SYSTEM

DRILLING /  
FIXING

## Locator assembly

- For Screwdrivers and Drywall Screwdrivers

CONCRETE  
DRILLING /  
DEMOLITION

MIXING /  
STIRRING

CUTTING  
(CONCRETE /  
METAL)

	For Model	Per Pkg	Part No
	6820V	1	122450-0
	6821	1	152483-1
	6823	1	151760-8
	6824, 6825	1	151726-8
	6826	1	152823-3
	FS2300, FS4300, FS6300	1	158876-0

GRINDING

## Front cap

- For socket bit
- For Screwdrivers and Drywall Screwdrivers



SANDING /  
POLISHING

For Model	Size (mm)	Per Pkg	Part No
6801B, 6850BV, 6827, FS2700	12	1	322070-2

SAWING

MULTI-TOOL

## Autofeed attachment set for Screwdrivers

- For Drywall screwdrivers
- Able to fasten even in a tight corner
- Reverse function
- One-touch attachment / removal with 8 angle settings



Optional Bits



For Model	Standard Equipment Bit	Part No	Part No
DFS250, DFS452, FS2300, FS4300, FS6300	Phillips No.2, Square No.2	199078-9	Optional Bits for Autofeed attachment set Phillips No.2 (5pcs) Part No. 199155-7

CLEANING

OPE

## Casing 55 set for Auto feed Screwdriver



For Model	Part No
DFR551	191W94-5

JOBSITE  
TOOLS

SPECIALTY  
TOOLS

## Long Bits for Auto feed Screwdriver

HAND TOOLS /  
COMBINATION SET

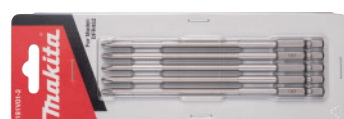

For Model	Type	Per Pkg	Part No
DFR551	+ bit 2-155 set	5pcs	191V02-0
DFR551	Square bit 2-155 set	5pcs	191V04-6
DFR551	Pozidrive bit 2-155 set	5pcs	191V06-2

TOOL HOLDERS  
AND POUCHES /  
MAKPAC SYSTEM

## Drywall screw strip

- For Auto Feed Screwdrivers
- 50pcs x 20 strips per box

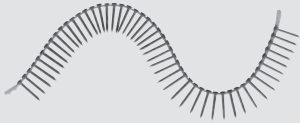
	For Model	Diameter (mm)	Per Pkg	Part No
	DFR550, 6832, 6834, 6835D, 6842	ø3.9 x 41	1000	P-04139
		ø4.0 x 32	1000	A-12413
		ø4.0 x 40	1000	A-12429

## Extension handle bar

- For Auto Feed Screwdrivers
- More comfortable and less fatigue and faster installation
- Enables user to use auto feed screwdriver on floor or ceiling



For Model	Dimension	Per Pkg	Part No
6832, 6834	890-990mm	1	192501-3
DFR550, 6842	-	1	194500-1

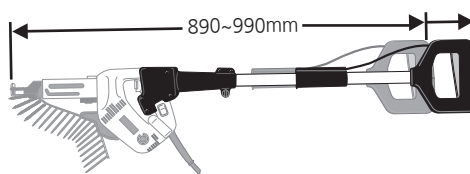

## Impact Black Impact Sockets



- \* Anti-rust treatment on the socket surface with high-class matte black appearance
- \* Large icons of socket hole shape and size with clear Makita logo on socket body
- \* Blue coloured O-ring groove increases the visibility and enables quick identification of brand



Impact Sockets for 1/2"(12.7mm) anvil 

Size	Length (mm)	Part No.
8mm	38	E-16047
10mm	38	E-16069
12mm	38	E-16081
13mm	38	E-16097
14mm	38	E-16106
17mm	38	E-16134
18mm	38	E-16140
19mm	38	E-16156
21mm	38	E-16178
22mm	38	E-16184
24mm	38	E-16209
27mm	42	E-16215
30mm	42	E-16221
32mm	44	E-16237

(all the above sockets are without O-ring & Pin)

Deep Impact Sockets for 1/2"(12.7mm) anvil 

Size	Length (mm)	Part No.
8mm	81.5	E-16405
10mm	81.5	E-16411
12mm	81.5	E-16433
13mm	81.5	E-16449
14mm	81.5	E-16455
17mm	81.5	E-16477
18mm	81.5	E-16483
19mm	81.5	E-16499
21mm	81.5	E-16508
22mm	81.5	E-16514
24mm	81.5	E-16520
27mm	81.5	E-16536
30mm	81.5	E-16542
32mm	81.5	E-16558

(all the above sockets are without O-ring & Pin)

DRILLING / FIXING

CONCRETE DRILLING / DEMOLITION

MIXING / STIRRING

CUTTING (CONCRETE / METAL)

GRINDING

SANDING / POLISHING

SAWING

MULTI-TOOL

ROUTERS / PLANERS

NEW

NAILERS / STAPLERS

HEAT GUN / LASER

CLEANING

OPE

JOB SITE TOOLS

SPECIALTY TOOLS

HAND TOOLS / COMBINATION SET

TOOL HOLDERS AND POUCHES / MAKPAC SYSTEM

DRILLING /  
FIXING

CONCRETE  
DRILLING /  
DEMOLITION

MIXING /  
STIRRING

CUTTING  
(CONCRETE /  
METAL)

GRINDING

SANDING /  
POLISHING

SAWING

MULTI-TOOL

ROUTERS /  
PLANERS

NAILERS /  
STAPLERS

HEAT GUN /  
LASER

CLEANING

OPE

JOBSITE  
TOOLS

SPECIALTY  
TOOLS

HAND TOOLS /  
COMBINATION SET

TOOL HOLDERS  
AND POUCHES /  
MAKPAC SYSTEM

## Impact socket for impact wrenches

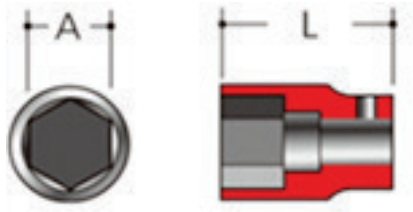

- For Impact Wrenches with 12.7mm (1/2") square drive.
- For model: 6953, 690VH, 6905B, TW005G, TW008G, TW0350, DTW285, DTW251, DTW181, DTW300, DTW701



A (MM)	L (MM)	PART NO
08mm	81.5mm	B-52146
10mm	81.5mm	B-52152
12mm	81.5mm	B-52174
13mm	81.5mm	B-52180
14mm	81.5mm	B-52196
17mm	81.5mm	B-52211
18mm	81.5mm	B-52227
19mm	81.5mm	B-52233
21mm	81.5mm	B-52249
22mm	81.5mm	B-52255
24mm	81.5mm	B-52261
27mm	81.5mm	B-52277
30mm	81.5mm	B-52283
32mm	81.5mm	B-52299

(all the above sockets are without O-ring & Pin)

## O ring set for 1/2"square impact socket



Size	Set	Part No
8mm -16mm	3pc	B-54542
17mm	3pc	B-54558
18mm and 19mm	3pc	B-54564
20mm - 32mm	3pc	B-54570

## Pin set for 1/2"square impact socket



Size	Set	Part No
8mm -16mm	3pc	B-54586
17mm	3pc	B-54592
18mm and 19mm	3pc	B-54601
20mm-32mm	3pc	B-54617

## Impact sockets for impact wrenches

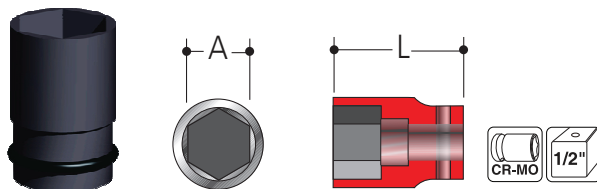

- For Impact Wrenches with 25.4mm (1") square drive.
- For model: 6910, TW1000

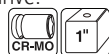

A (mm)	L (mm)	Per Pkg	Part No
35	80	1	134864-1
36	80	1	134865-9
41	80	1	134872-2

(all the above sockets are with Pin and O-Ring)

- For Impact Wrenches with 12.7mm (1/2") square drive.
- For model: 6953, 690VH, 6905B, TW005G, TW008G, TW0350, DTW285, DTW251, DTW181, DTW300, DTW701



A (mm)	L (mm)	Per Pkg	Part No
27	50	1	134844-7
27	78	1	134845-5
30	50	1	134846-3
30	78	1	134847-1
32	50	1	134848-9
32	78	1	134849-7

## Impact sockets for impact wrenches

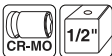
- For Impact Wrenches with 12.7mm (1/2") square drive. 
- For model: 6953, 690VH, 6905B, TW005G, TW008G TW0350, DTW285, DTW251, DTW181, DTW300, DTW701

A (mm)	L (mm)	Per Pkg	Part No
12	75	1	134867-5
13	38	1	134825-1
13	52	1	134827-7
14	38	1	134826-9
14	52	1	134828-5
17	38	1	134829-3
17	52	1	134830-8
19	38	1	134831-6
19	52	1	134832-4
19	78	1	134837-4
21	38	1	134838-2
21	52	1	134833-2
21	78	1	134839-0
22	38	1	134851-0
22	52	1	134834-0
23	38	1	134840-5
23	52	1	134835-8
24	45	1	134841-3
24	52	1	134836-6
26	50	1	134842-1
26	78	1	134843-9

- For Impact Wrenches 19mm (3/4") square drive. 
- For model: 6906, TW001G, DTW1001

A (mm)	L (mm)	Per Pkg	Part No
17	50	1	A-85494
17	95	1	A-85503
19	50	1	A-85519
19	95	1	A-85525
21	52	1	A-85531
21	95	1	A-85547
22	52	1	A-85553
22	95	1	A-85569
24	52	1	A-85575
24	95	1	A-85581
26	52	1	134853-6
26	95	1	134854-4
27	52	1	134855-2
27	95	1	134856-0
30	52	1	134857-8
30	95	1	134858-6
32	52	1	134871-4
32	95	1	134859-4
35	56	1	134860-9
36	56	1	134862-5
36	95	1	134863-3

## 9pcs 1/2" Impact Socket with Socket Adapter Set

- It allows impact driver to fasten or loosen bolt and nut
- Ball type socket adapter allows easy attaching or detaching sockets

Sizes: 8, 10, 12, 13, 14, 15, 17, 18mm  
Socket adapter 50mm



(1pc Socket Adaptor and 8pcs Impact Socket)



Rubber holder with Blister pack



TYPE	SHANK TYPE	SIZE	FOR	PER PKG	PKG WITH COUNTRY OF ORIGIN	PART NO
1/4"Hex (NZ)	NZ-B	SQ 1/2"	Impact drivers	9pcs/ (1 set)	Yes	B-55762

DRILLING / FIXING

CONCRETE DRILLING / DEMOLITION

MIXING / STIRRING

CUTTING (CONCRETE / METAL)

GRINDING

SANDING / POLISHING

SAWING

MULTI-TOOL

ROUTERS / PLANERS

NAILERS / STAPLERS

HEAT GUN / LASER

CLEANING

OPE

JOBSITE TOOLS

SPECIALTY TOOLS

HAND TOOLS / COMBINATION SET

TOOL HOLDERS AND POUCHES / MAKPAC SYSTEM

DRILLING /  
FIXING

## 14pcs 1/2" Drive Deep Impact Socket Bit Set

- Deep socket makes it possible to fasten and loosen the nut to further long bolt and able to work on such a long protruded bolt



CONCRETE  
DRILLING /  
DEMOLITION

MIXING /  
STIRRING

CUTTING  
(CONCRETE /  
METAL)

GRINDING

DESCRIPTION	SIZE (MM)	PER PKG	PKG WITH COUNTRY OF ORIGIN	PART NO
For 1/2"(12.7mm) anvil with O-ring and Pin	10, 11, 12, 13, 14, 16, 17, 19, 21, 22, 24, 27, 30, 32 x 81.5mm	14pcs/ (1 set)	Yes	B-52308

SANDING /  
POLISHING

## 3pcs 1/2" Drive Multi Color Deep Impact Socket Bit Set

- Deep Impact sockets come with plastic sleeve + plastic bolt top to protect both the rim and the wheel nut from scratches
- Each size of the impact socket plastic sleeves has different colour for easy size identification
- Set includes fabric bag with belt loop for safe storage



Plastic Sleeve



Plastic bolt top



SAWING

MULTI-TOOL

SIZE (MM)	LENGTH	PART NO
17mm (Blue)   19mm (Yellow)   21mm (Red)	86 mm	E-12354

Pin and O-ring are not included with the socket

ROUTERS /  
PLANERS

NAILERS /  
STAPLERS

## Extension for 1/2" Square Drive Impact Wrench

- To fasten bolts and nuts wherever deep socket cannot reach
- It has ball type extension which allows easy attaching or detaching sockets



HEAT GUN /  
LASER

CLEANING

SIZE	LENGTH (MM)	PER PKG	PART NO EXTENSION	PART NO PIN	PART NO O-RING
1/2"	250	1	B-55706	B-54586	B-54542
1/2"	150	1	B-55712	B-54586	B-54542
1/2"	75	1	B-55728	B-54586	B-54542

Pin and O-ring are included with the socket

OPE

JOBSITE  
TOOLS

## Extension Handle Set for Impact Wrench

- By attaching this extension, the user can do downward bolt-tightening/loosening continuously without bending over
- Telescopic pipe section is adjustable to user's height in 5 stages by pulling the knob.



SPECIALTY  
TOOLS

HAND TOOLS /  
COMBINATION SET

FOR MODEL	OVERALL LENGTH	PART NO
TW008G, DTW1001, DTW701	657mm - 807mm Range of motion: 150mm	191G67-2

TOOL HOLDERS  
AND POUCHES /  
MAKPAC SYSTEM



## Extension for 1/2" | 3/5" | 1" Square Drive Impact Wrench

- To fasten bolts and nuts wherever deep socket cannot reach



FOR MODEL	SIZE	LENGTH (MM)	PER PKG	PART NO
6918D , 6953, 6904VH, TW005G, TW008G, DTW181, DTW251, DTW281, DTW285, DTW300, DTW701	1/2"	100	1	134874-8
TW001G, DTW1001, 6906	3/4"	150	1	134997-2
6910, TW1000	1"	200	1	134870-6

(All the above sockets are with O-ring & Pin)

- DRILLING / FIXING
- CONCRETE DRILLING / DEMOLITION
- MIXING / STIRRING
- CUTTING (CONCRETE / METAL)
- GRINDING
- SANDING / POLISHING
- SAWING
- MULTI-TOOL
- ROUTERS / PLANERS
- NAILERS / STAPLERS
- HEAT GUN / LASER
- CLEANING
- OPE
- JOBSITE TOOLS
- SPECIALTY TOOLS
- HAND TOOLS / COMBINATION SET
- TOOL HOLDERS AND POUCHES / MAKPAC SYSTEM

## Bit Adapter Assembly

- For 1/2" Impact Wrenches.
- Enables tool to fasten machine screws.
- Comes with Pin and O ring
- Application: Cladding roofing steel



FOR MODEL	SIZE	PER PKG	PART NO
6918D , 6953, 6904VH, TW005G, TW008G, DTW181, DTW251, DTW281, DTW285, DTW300, DTW701	1/2"	1	134873-0

## Universal Joint

- Universal joint alters angle of drive for impact wrenches.
- For use in a limited space where the tool cannot be held in line with the axis of the bolt or nut.
- Greater flexibility.



FOR MODEL	SIZE	LENGTH (MM)	PER PKG	PART NO
6918D , 6953, 6904VH, DTW190, DTW181, DTW251, DTW281, DTW285, DTW300, DTW450, DTW701, TW005G, TW008G	1/2"	84	1	134877-2
TW001G, DTW1001, 6906	3/4"	150	1	134998-0

(All the above sockets are with O-ring & Pin)

## 1/4" Hex shank screwdriver bits adapter

- for 1/2" square driver impact wrenches
- Enables tool to fasten machine screws.



Connects with 1/2" Square drive Impact Wrenches



Comes with Pin and O ring

FOR MODEL	SIZE	PER PKG	PART NO
6918D , 6953, 6904VH, TW005G, TW008G, DTW181, DTW251, DTW281, DTW285, DTW300, DTW701	1/2"	1	B-68476

## Drill Chuck Assembly

For Impact Driver



FOR MODEL	PER PKG	PART NO.
CONNECT BIT 6.35-48 NZ FOR IMPACT DRIVER	1	191880-6

DRILLING / FIXING

### Drill Bit Remover Set

Use it with the impact wrench for removing SDS-MAX bit stuck on rebar in concrete.



FOR MODEL	PER PKG	PART NO.
Use with impact Wrench	1	195870-1

CONCRETE DRILLING / DEMOLITION

### Angle Attachments for TL064 / TL065

Impact driver Impact Wrench

Straight head



Ratchet head



Part No.

192439-2

Part No.

192440-7

MIXING / STIRRING

CUTTING (CONCRETE / METAL)



GRINDING

### Socket Adapter for TL064 / TL065

Impact driver Impact Wrench

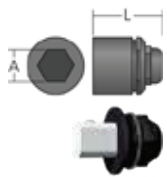

use with Ratchet head

Size	Part No.
9.5mm (3/8")	134745-9
12.7mm (1/2")	134746-7

### Socket adapter Ratchet Wrench DWR180, WR100D

use with Ratchet head

Size	Part No.
9.5mm (3/8")	191A50-3
6.3mm (1/4")	191A51-1



SANDING / POLISHING

SAWING

### Grip Assembly

• For Impact Wrenches.



FOR MODEL	PER PKG	PART NO
6906	1	122464-9
6910	1	123018-5
6910	1	122464-9
TW1000	1	122727-3

MULTI-TOOL

ROUTERS / PLANERS

### Protector Cover



FOR MODEL	TYPE	PER PKG	PART NO
TW001G	A	1	413G38-2
DTW701, TW008G	A	1	413G39-0
DTW1001, DTW800	A	1	413G40-5
TD1112	B	1	422718-7

NAILERS / STAPLERS

HEAT GUN / LASER

CLEANING

### Tool Catcher Set

- Enables to hook the machine on a snap hook of waist belt.
- This is convenient for temporarily hanging the tool from belt.
- Usage of this clip helps users to keep their hands free while working at elevated work site.

**Type A:** Tool catcher set can be used for below types of cordless machine

- DDA ANGLE DRILL
- DDF DRIVER DRILL
- DHP PERCUSSION DRIVER DRILL
- DTD IMPACT DRIVER
- DTP 4 MODE IMPACT DRIVER
- DTW IMPACT WRENCH
- DPT PIN NAILER
- DST STAPLER



### Type B: Tool catcher set with shoulder belt

Can be used with DTD152, DTD134, DTD148, DTD170, DTS141, DTW190, DTW250, DTW251, DTW280, DTW281, DTW285, DTW181, DTD152, DTD171, DTW300, DTW301



For model		Part No.
Type A	Hook	197043-2
Type B	Strap with Hook	197941-0
TD001G, TW004G, TW005G	Hook	191F58-7
TD112D	Hook	281012-4

OPE

JOBSITE TOOLS

SPECIALTY TOOLS

HAND TOOLS / COMBINATION SET

TOOL HOLDERS AND POUCHES / MAKPAC SYSTEM

# Concrete Drilling | Demolition

Rotary / Combination Hammers, Chipping Hammers, Demolition Hammers, Power Scrapers



# Anti Vibration Technology

The benchmark in vibration reduction Makita demolition tools are among the best in the world. Working with users to solve this problem, Makita's AVT products have been designed in close relation to users needs at site level.

## Under load



### Active Protection

#### Active dynamic absorber

Shift of air pressure in crank room and barrel room "actively" controls balancer to move opposite of piston.

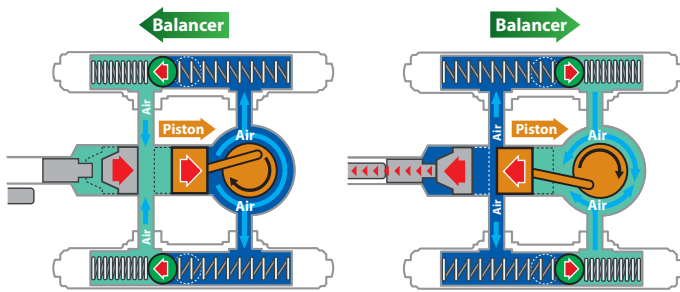

# AVT

ANTI VIBRATION TECHNOLOGY



### Passive Protection

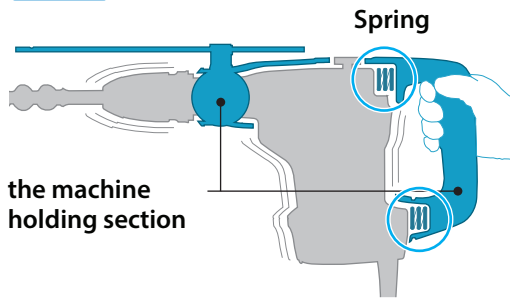

#### Vibration absorbing housing

The level of vibration is further reduced by completely separating the machine holding section from the motor/transmission section

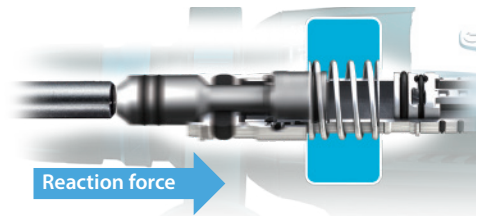

#### Damper spring

absorbs reaction force caused by drill bit at the moment of impact.

## During No-load

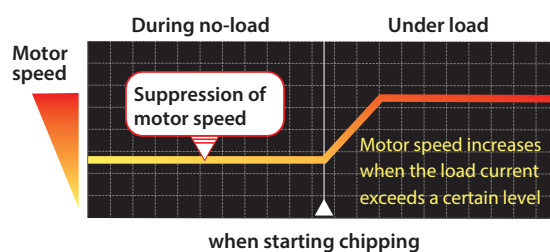

### Soft no load function

- reduces vibration of tool body when idling, accordingly decreases the amount of vibration to operator's hands during a day's operation.
- minimizes deflection of bit tip from aiming point when starting chipping.

## Compatibility list between Cordless Hammers and Drill Bits

Capacity	Bit	Model No.	Joules	Weight	Battery	0 5 10 15 20 25 30 40 50 60 70 80 90 100 110 120 130 140 150 160																			
						Scale (mm)																			
16 mm		HR166D	1.0 J	1.6kg	12V max	3.2-16		3.2-10		Diamond Core Bit/Core Bit not recommended															
17 mm		DHR171	1.2 J	2.1kg	18V	3.2-17		3.2-10		Diamond Core Bit/Core Bit not recommended															
18 mm		DHR182	1.7 J	2.5kg	18V	3.2-18		3.2-10		35	Diamond Core Bit (Dry Type): 32 mm														
18 mm		DHR183	1.7 J	2.2kg	18V	3.2-18		3.2-10		Diamond Core Bit/Core Bit not recommended															
20 mm		DHR202	1.9 J	2.8kg	18V	3.2-20		4-12		35-54		Diamond Core Bit (Dry Type): 32 mm													
20 mm		HR010G	2.0 J	2.2kg	40Vmax	3.2-20		4-12		35-54		Diamond Core Bit (Dry Type): 32 mm													
24 mm		DHR242	2.0 J	2.6kg	18V	3.2-24		4-16		35-54		Diamond Core Bit (Dry Type): 32-65 mm													
26 mm		DHR263	3.0 J	3.2kg	36V	3.2-26		4-18		35-54		Diamond Core Bit (Dry Type): 32-65 mm													
28 mm		DHR280 / DHR281 DHR283	3.2 J	3.5kg/ 3.7kg/ 3.7kg	36V	3.2-28		6-20		35-54		Diamond Core Bit (Dry Type): 32-65 mm													
28 mm		HR002G HR003G	2.9 J / 2.8 J	3.6kg	40Vmax	3.2-28		6-20		35-54		Diamond Core Bit (Dry Type): 32-65 mm													
28 mm		HR007G	3.0 J	3.0kg	40Vmax	3.2-28		6-20		35-54		Diamond Core Bit (Dry Type): 32-65 mm													
30 mm		HR008G	3.9 J	3.9kg	40Vmax	6-30		8-22		35-80		Diamond Core Bit (Dry Type): 32-80 mm													
40 mm		DHR400N	8.0 J	7.2kg	36V	10-40		16-35		20-105															
40 mm		HR005G	8.0 J	6.3kg	40Vmax	10-40		16-35		20-105															
52 mm		HR006G	21.4 J	10.8kg	80Vmax	19-52		25-45		20-160															

- Adapted for SDS-MAX bits
- Adapted for SDS-PLUS bits

- Compatible size range of TCT Drill Bit
- Recommended size range of Drill Bit
- Compatible size range of Core Bit

- DRILLING / FIXING
- CONCRETE DRILLING / DEMOLITION
- MIXING / STIRRING
- CUTTING (CONCRETE / METAL)
- GRINDING
- SANDING / POLISHING
- SAWING
- MULTI-TOOL
- ROUTERS / PLANERS
- NAILERS / STAPLERS
- HEAT GUN / LASER
- CLEANING
- OPE
- JBSITE TOOLS
- SPECIALTY TOOLS
- HAND TOOLS / COMBINATION SET
- TOOL HOLDERS AND POUCHES / MAKPAC SYSTEM

- DRILLING / FIXING
- CONCRETE DRILLING / DEMOLITION
- MIXING / STIRRING
- CUTTING (CONCRETE / METAL)
- GRINDING
- SANDING / POLISHING
- SAWING
- MULTI-TOOL
- ROUTERS / PLANERS
- NAILERS / STAPLERS
- HEAT GUN / LASER
- CLEANING
- OPE
- JOBSITE TOOLS
- SPECIALTY TOOLS
- HAND TOOLS / COMBINATION SET
- TOOL HOLDERS AND POUCHES / MAKPAK SYSTEM



40V MAX XGT - Rotary / Combi Hammers Range

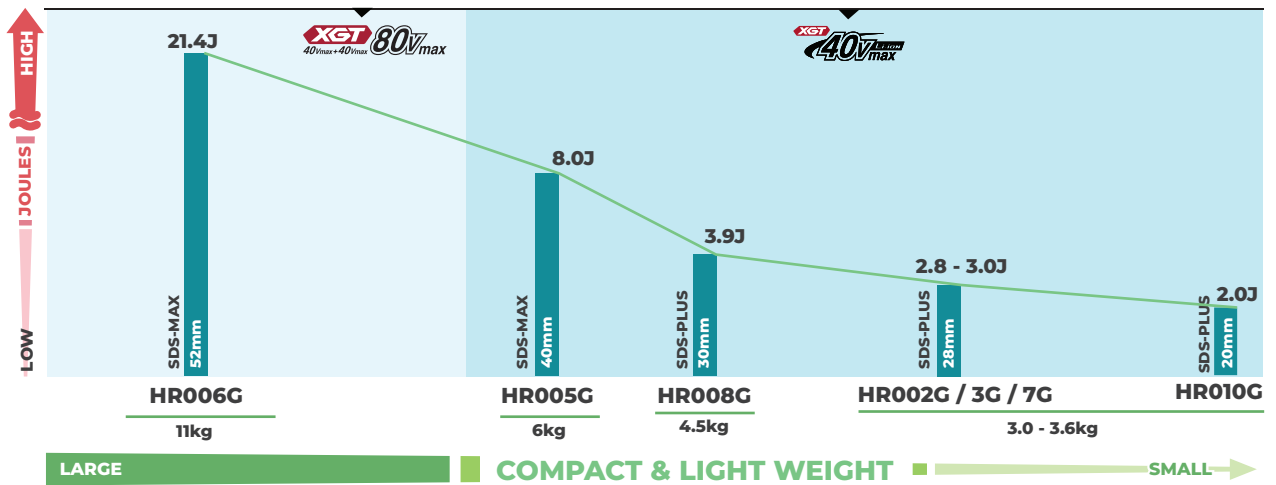

**HR006G 52mm**
80V MAX | XGT

**Cordless Rotary Hammer (SDS-MAX)**

21.4J

2 mode

**Heavy Duty Performance - with the twin battery system, the tool achieves the 80v max power (40v max + 40v max).**

- Combination of XGT system with powerful brushless motor provides high impact energy of 21.4J and delivers higher drilling efficiency.
- Low Vibration with Anti-Vibration Technology

Impact Energy	21.4 J (EPTA Value)
Capacity	(with TCT Bit): 52 mm / (with Core Bit): 160 mm
Blows Per Minute (BPM)	1,100 - 2,250
No Load Speed (RPM)	150 - 310
Sound Pressure Level	99 dB(A)
Sound Power Level	110 dB(A)
Vibration Level	Chiselling Function : 7.0 m/s <sup>2</sup> / Hammer Drilling: 8.5 m/s <sup>2</sup>
Dimensions (L x W x H)	610 x 140 x 337 mm (with 4.0Ah battery)
Net weight	10.8 kg (without battery)

**Standard Equipment:** Side Grip, Depth Gauge

AVAILABLE VARIANTS

"Z" VARIANT

**HR006G Z**  
TOOL ONLY (WITH CARRY CASE)  
(DOES NOT INCLUDE BATTERY / CHARGER)

**HR005G 40mm**
40V MAX | XGT

**Cordless Rotary Hammer (SDS-MAX)**

8.0J

2 mode

**Heavy Duty Performance with Superior Power with 40v max XGT battery**

- Low Vibration with Anti-Vibration Technology

Impact Energy	8.0 J (EPTA) 11.4J (Non EPTA Value)
Capacity	Concrete (w/ TCT Bit): 40 mm
Blows Per Minute (BPM)	1,450 - 2,900
No Load Speed (RPM)	250 - 500
Sound Pressure Level	91 dB(A)
Sound Power Level	102 dB(A)
Vibration Level	Hammer Drilling into Concrete: 5.0 m/s <sup>2</sup> Chiselling Function : 4.0 m/s <sup>2</sup>
Dimensions (L x W x H)	477 x 115 x 286 mm (without battery)
Net weight	6.3 kg (without battery & grip)

**Standard Equipment:** Side Grip, Depth Gauge

AVAILABLE VARIANTS

"Z" VARIANT

**HR005G Z**  
TOOL ONLY (WITH CARRY CASE)  
(DOES NOT INCLUDE BATTERY / CHARGER)

**HR008G** 30mm **40V MAX | XGT**

**Cordless Combination Hammer (SDS-PLUS)**

**NEW**



**3.9J** **3 mode**

**Powerful yet with low vibration compared to similar range of corded models**

- Drilling efficiency drastically increased with new hammering mechanism
- Compatible with DX10 dust collection system (optional)

**Impact Energy** 3.9 J (EPTA)  
**Capacity** Concrete / Steel / Wood / Core Bit / Diamond Core Bit (Dry Type): 30 / 13 / 32 / 80 / 80 mm  
**Blows Per Minute (BPM)** 0 - 4,500  
**No Load Speed (RPM)** 0 - 840  
**Vibration Level** Hammer Drilling into Concrete: 9.1 m/s<sup>2</sup>  
**Sound Pressure Level** 94 dB(A)  
**Dimensions (L x W x H)** 396 x 97 x 242 mm  
**Net weight** 4.5kg (without battery)

**Standard Equipment:** Side Grip, Depth Gauge

**AVAILABLE VARIANTS**

4.0Ah	"Z" VARIANT
<b>HR008G M2</b> INCLUDES 2 BATTERIES / 1 CHARGER / CARRYCASE	<b>HR008G Z</b> TOOL ONLY (DOES NOT INCLUDE BATTERY / CHARGER / CARRYCASE)

**HR007G** 28mm **40V MAX | XGT**

**Cordless Combination Hammer (SDS-PLUS)**

**NEW**



**3.0J** **3 mode**

**Excellent drilling performance, compact & lightweight**

- Higher work efficiency than other 28mm XGT hammers
- Compatible with DX15 dust collection system (optional)

**Impact Energy** 3.0 J (EPTA)  
**Capacity** Concrete / Steel / Wood / Core Bit / Diamond Core Bit (Dry Type): 28 / 13 / 32 / 54 / 65 mm  
**Blows Per Minute (BPM)** 0 - 5,000  
**No Load Speed (RPM)** 0 - 980  
**Vibration Level** Hammer Drilling into Concrete: 7.5 m/s<sup>2</sup>  
 Chiselling Function w/ Side Grip: 8.6 m/s<sup>2</sup>  
**Sound Pressure Level** 94 dB(A)  
**Sound Power Level** 105 dB(A)  
**Dimensions (L x W x H)** 456 x 101 x 185 mm  
**Net weight** 3.0 kg (without battery)

**Standard Equipment:** Side Grip, Depth Gauge

**AVAILABLE VARIANTS**

4.0Ah	"Z" VARIANT
<b>HR007G M2</b> INCLUDES 2 BATTERIES / 1 CHARGER / CARRYCASE	<b>HR007G Z</b> TOOL ONLY (DOES NOT INCLUDE BATTERY / CHARGER)

**HR002G** 28mm **40V MAX | XGT**

**Cordless Combination Hammer (SDS-PLUS)**

**Quick change drill chuck 199139-5 (standard)**



**2.9J** **3 mode**

**Excellent drilling performance, Extremely compact & lightweight combination hammer**

- Compatible with DX14 dust collection system (optional)

**Impact Energy** 2.9 J (EPTA)  
**Capacity** Concrete 28 / Steel 13 / Wood 32 / Core Bit 54 / Diamond Core Bit (Dry Type) 65 mm  
**Blows Per Minute (BPM)** 0 - 5,000  
**No Load Speed (RPM)** 0 - 980  
**Chuck Capacity** 1.5 - 13 mm  
**Sound Pressure Level** 93 dB(A)  
**Sound Power Level** 104 dB(A)  
**Dimensions (L x W x H)** 387x102x232 mm  
**Net weight** 3.6 kg (without battery)

**Standard Equipment:** Side Grip, Depth Gauge, QCD chuck

**AVAILABLE VARIANTS**

4.0Ah	"Z" VARIANT
<b>HR002G M2</b> INCLUDES 2 BATTERIES / 1 CHARGER / MAKPAC CONNECTOR CASE	<b>HR002G Z</b> TOOL ONLY (DOES NOT INCLUDE BATTERY / CHARGER / BLUETOOTH CHIP / CARRYING CASE)

**HR003G** 28mm **40V MAX | XGT**

**Cordless Combination Hammer (SDS-PLUS)**



**2.8J** **3 mode**

**Excellent drilling performance, Extremely compact & lightweight combination hammer**

- Good Tool Balance for Increased Operability

**Impact Energy** 2.8 J (EPTA)  
**Capacity** Concrete 28 / Steel 13 / Wood 32 / Core Bit 54 / Diamond Core Bit (Dry Type) 65 mm  
**Blows Per Minute (BPM)** 0 - 5,000  
**No Load Speed (RPM)** 0 - 980  
**Chuck Capacity** 1.5 - 13 mm  
**Sound Pressure Level** 95 dB(A)  
**Sound Power Level** 106 dB(A)  
**Dimensions (L x W x H)** 356x102x232 mm  
**Net weight** 3.6 kg (without battery)

**Standard Equipment:** Side Grip, Depth Gauge

**AVAILABLE VARIANTS**

4.0Ah	"Z" VARIANT
<b>HR003G M2</b> INCLUDES 2 BATTERIES / 1 CHARGER / MAKPAC CONNECTOR CASE	<b>HR003G Z</b> TOOL ONLY (DOES NOT INCLUDE BATTERY / CHARGER / CARRYING CASE)

- DRILLING / FIXING
- CONCRETE DRILLING / DEMOLITION
- MIXING / STIRRING
- CUTTING (CONCRETE / METAL)
- GRINDING
- SANDING / POLISHING
- SAWING
- MULTI-TOOL
- ROUTERS / PLANERS
- NAILERS / STAPLERS
- HEAT GUN / LASER
- CLEANING
- OPE
- JOB SITE TOOLS
- SPECIALTY TOOLS
- HAND TOOLS / COMBINATION SET
- TOOL HOLDERS AND POUCHES / MAKPAC SYSTEM

- DRILLING / FIXING
- CONCRETE DRILLING / DEMOLITION
- MIXING / STIRRING
- CUTTING (CONCRETE / METAL)
- GRINDING
- SANDING / POLISHING
- SAWING
- ROUTERS / PLANERS
- NAILERS / STAPLERS
- HEAT GUN / LASER
- CLEANING
- OPE
- JOBSITE TOOLS
- SPECIALTY TOOLS
- HAND TOOLS / COMBINATION SET
- TOOL HOLDERS AND POUCHES / MAKPAC SYSTEM

**HR010G 20mm** 40V MAX | **XGT**

**Cordless Combination Hammer (SDS-PLUS)**



**Excellent drilling performance, compact & lightweight**

- Higher work efficiency than other 28mm XGT hammers
- Compatible with DX15 dust collection system (optional)



Impact Energy	2.0 J (EPTA)
Capacity	Concrete / Steel / Wood : 20 / 13 / 26mm
Blows Per Minute (BPM)	0 - 5,000
No Load Speed (RPM)	0 - 1,510
Dimensions (L x W x H)	289 x 93 x 217 mm
Net weight	2.2 kg (without battery)

**Standard Equipment:** Side Grip, Depth Gauge

**AVAILABLE VARIANTS**

2.5Ah	"Z" VARIANT
<b>HR010G D2</b> INCLUDES 2 BATTERIES / 1 CHARGER / CARRYCASE	<b>HR010G Z</b> TOOL ONLY (DOES NOT INCLUDE BATTERY / CHARGER)

**Dust Extraction System for effective cleaning**

**The Dust Extractor Attachment with HEPA Filter to capture concrete dust during drilling** **HEPA filter**  
Overall length: 260mm

- **Depth gauge** can be adjusted simply by pushing a button
- **Transparent dust case** for easy checking of collected dust amount
- **Filter cleaning mechanism** - the dust falls off from the filter by turning the dial
- **Twin LED job light**
- **Large dust case cover** can be opened simply by pushing a single push button for easy dust cleaning



	DX14 (191E58-1)	DX12 (191E52-3)	DX15 (191X39-9)	DX10 (191F95-1)	DX16 (191P2-6)
Compatible tool	HR002G	HR003G	HR007G, HR2663	HR008G, HR3011FC	HR010G, DHR183
Dust capacity	400 mL	400 mL	400 mL	400 mL	400 mL
Bit dia	28 mm	28 mm	28 mm	30 mm	20 mm
Bit length	160 mm	160 mm	260 mm	265 mm	165 mm
Usable length	190 mm	190 mm	190	190 mm	105 mm
Net weight	1.6kg	1.6kg	1.2kg	1.2kg	0.77kg



**18V LXT - Rotary / Combi Hammers Range**

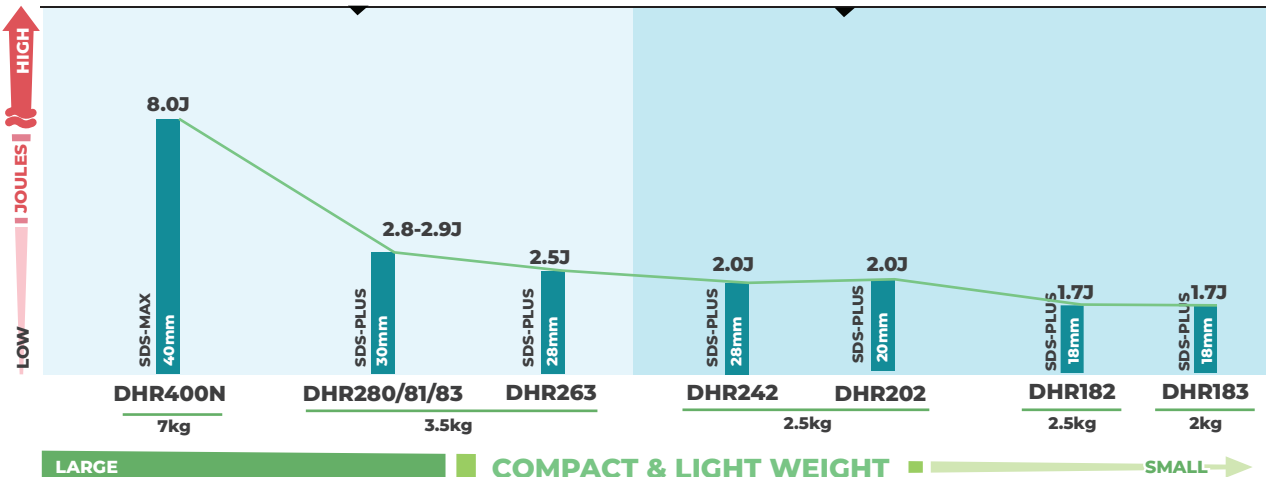



**DHR400N** 40mm **18Vx2 LXT**

**Cordless Rotary Hammer (SDS-MAX)**



**8.0 JOULES**  
 2 mode  
 Hammering with rotation  
 Rotation only

**SDS-MAX Rotary hammer - Powered by two 18V Li-ion batteries**

- Excellent performance equivalent to AC Model
- BL Motor & AVT + SOFT NO LOAD Functions Deliver High Power and Low Vibration
- 2 Mode operation - Hammering with rotation and Rotation only
- With auto wireless system

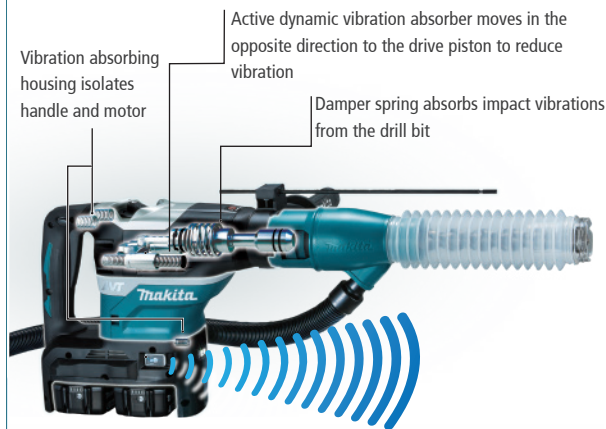

**AFT - Smart function to minimize the danger of kick-back**  
 AFT function shuts down the tool, if the rotation speed suddenly slows down



**Bluetooth**  
**AWS** Auto-start Wireless System  
 Wireless unit 198900-7



**AWS AVT & SOFT NO LOAD AFT**

Impact Energy	8.0 J (EPTA) 11.4 J (Non EPTA)
Capacity	Concrete (w/ T.C.T. bit) : 40 mm Concrete (w/ Core bit) : 105 mm
Blows Per Minute (BPM)	1,450 - 2,900
No Load Speed (RPM)	250 - 500
Sound Pressure Level	91 dB(A)
Sound Power Level	102 dB(A)
Vibration Level	Hammer Drilling Into Concrete: 5.0 m/s <sup>2</sup>
Dimensions(L x W x H)	473x120x285 mm
Net weight	7.2kg (without battery)

**Standard Equipment:** Side Handle, Depth Gauge

**AVAILABLE VARIANTS**

**"Z" VARIANT**

**DHR400N ZKU**  
 TOOL ONLY - WITH CARRY CASE AND BLUETOOTH CHIP (DOES NOT INCLUDE BATTERY / CHARGER)

**DHR283** 28mm **18Vx2 LXT**

**Cordless Combination Hammer (SDS-PLUS)**

- BL Motor & AVT + SOFT NO LOAD Functions Deliver High Power and Low Vibration
- AFT function shuts down the tool, if the rotation speed suddenly slows down



**AWS AVT AFT**

Impact Energy	2.9 J (EPTA) 3.2 J (Non EPTA)
Capacity	Concrete / Steel / Wood / Core Bit / Diamond Core Bit: 28 / 13 / 32 / 54 / 65 mm
Blows Per Minute (BPM)	0 - 5,000
No Load Speed (RPM)	0 - 980
Vibration Level	Hammer Drilling into Concrete: 9.5 m/s <sup>2</sup>
Sound Pressure / Power Level	92 dB(A) / 03 dB(A)
Dimensions (L x W x H)	404x134x232 mm
Net weight	3.7 kg (without battery)

**Standard Equipment:** Depth Gauge, Side Grip, Quick change drill chuck

**AVAILABLE VARIANTS**

**"Z" VARIANT**

**DHR283 ZJ**  
 TOOL ONLY - WITH MAKPACK CASE (DOES NOT INCLUDE BATTERY / CHARGER / BLUETOOTH CHIP)

**DHR281** 28mm **18Vx2 LXT**

**Cordless Combination Hammer (SDS-PLUS)**



- BL Motor & AVT + SOFT NO LOAD Functions Deliver High Power and Low Vibration



**AVT & SOFT NO LOAD**

Impact Energy	2.9 J (EPTA) 3.2 J (Non EPTA)
Capacity	Concrete / Steel / Wood / Core Bit / Diamond Core Bit (Dry Type): 28 / 13 / 32 / 54 / 65 mm
Blows Per Minute (BPM)	0 - 5,000
No Load Speed (RPM)	0 - 980
Vibration Level	Hammer Drilling into Concrete: 9.5 m/s <sup>2</sup> Drilling Into Metal: 2.5 m/s <sup>2</sup>
Sound Pressure Level	92 dB(A)
Sound Power Level	103 dB(A)
Dimensions (L x W x H)	404x134x232 mm
Net weight	3.7 kg (without battery)

**Standard Equipment:** Depth Gauge, Side Grip, Quick change drill chuck

**AVAILABLE VARIANTS**

<b>5.0Ah</b>	<b>"Z" VARIANT</b>
<b>DHR281 PT2</b> INCLUDES 2 BATTERIES / 1 TWO PORT CHARGER AND MAKPACK CASE	<b>DHR281 ZJ</b> TOOL ONLY - WITH MAKPACK CASE (DOES NOT INCLUDE BATTERY / CHARGER)

DRILLING / FIXING
CONCRETE DRILLING / DEMOLITION
MIXING / STIRRING
CUTTING (CONCRETE / METAL)
GRINDING
SANDING / POLISHING
SAWING
MULTI-TOOL
ROUTERS / PLANERS
NAILERS / STAPLERS
HEAT GUN / LASER
CLEANING
OPE
JOBSITE TOOLS
SPECIALTY TOOLS
HAND TOOLS / COMBINATION SET
TOOL HOLDERS AND POUCHES / MAKPACK SYSTEM

- DRILLING / FIXING
- CONCRETE DRILLING / DEMOLITION
- MIXING / STIRRING
- CUTTING (CONCRETE / METAL)
- GRINDING
- SANDING / POLISHING
- SAWING
- MULTI-TOOL
- ROUTERS / PLANERS
- NAILERS / STAPLERS
- HEAT GUN / LASER
- CLEANING
- OPE
- JOB SITE TOOLS
- SPECIALTY TOOLS
- HAND TOOLS / COMBINATION SET
- TOOL HOLDERS AND POUCHES / MAKPAC SYSTEM

DHR280 28mm 18Vx2 LXT

**Cordless Combination Hammer (SDS-PLUS)**



2.8  
JOULES



3 mode

**SDS-PLUS Combination hammer - Powered by two 18V Li-ion batteries**

- BL Motor & AVT + SOFT NO LOAD Functions Deliver High Power and Low Vibration
- 3 Mode operation - Rotation only, Hammering with rotation and Hammering only



**AVT+SOFT NOLOAD**

<b>Impact Energy</b>	2.8 J (EPTA) 3.2 J (Non EPTA)
<b>Capacity</b>	Concrete / Steel / Wood / Core Bit / Diamond Core Bit (Dry Type): 28 / 13 / 32 / 54 / 65 mm
<b>Blows Per Minute (BPM)</b>	0 - 5,000
<b>No Load Speed (RPM)</b>	0 - 980
<b>Vibration Level</b>	Hammer Drilling into Concrete: 9.5 m/s <sup>2</sup> Drilling Into Metal: 2.5 m/s <sup>2</sup>
<b>Sound Pressure Level</b>	92 dB(A)
<b>Sound Power Level</b>	103 dB(A)
<b>Dimensions (L x W x H)</b>	404x134x232 mm
<b>Net weight</b>	3.5 kg (without battery)

**Standard Equipment:** Depth Gauge, Side Grip

AVAILABLE VARIANTS

5.0Ah	"Z" VARIANT
<b>DHR280 PT2</b> INCLUDES 2 BATTERIES / 1 TWO PORT CHARGER AND MAKPAC CASE	<b>DHR280 ZJ</b> TOOL ONLY - WITH MAKPAC CASE (DOES NOT INCLUDE BATTERY / CHARGER)

DHR263 26mm 18Vx2 LXT

**Cordless Combination Hammer (SDS-PLUS)**



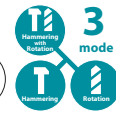

3.0  
JOULES



3 mode

**Combination hammer - Powered by two 18V Li-ion batteries**

- Vibration absorbing handle provides comfortable operation
- 3 Mode operation - Rotation only, Hammering with rotation and Hammering only
- Ergonomic soft grip handle and large 2-finger trigger provide increased comfort on the job

<b>Impact Energy</b>	2.5 J (EPTA) 3.0 J (Non EPTA)
<b>Capacity</b>	Concrete / Steel / Wood: 26 / 13 / 32 mm
<b>Blows Per Minute (BPM)</b>	0 - 5,000
<b>No Load Speed (RPM)</b>	0 - 1,250
<b>Vibration Level</b>	Hammer Drilling Into Concrete: 15.5 m/s <sup>2</sup> Drilling Into Metal: 5.0 m/s <sup>2</sup>
<b>Sound Pressure / Power Level</b>	94 dB(A) / 105 dB(A)
<b>Dimensions (L x W x H)</b>	374x116x232 mm
<b>Net weight</b>	3.2 kg (without battery)

**Standard Equipment:** Depth Gauge, Side Grip.

AVAILABLE VARIANTS

3.0Ah	"Z" VARIANT
<b>DHR263 RF2</b> INCLUDES 2 BATTERIES / 1 CHARGER AND CARRY CASE	<b>DHR263 Z</b> TOOL ONLY (DOES NOT INCLUDE BATTERY / CHARGER)

DHR242 24mm 18V LXT

**Cordless Combination Hammer (SDS-PLUS)**



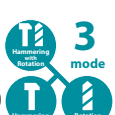

2.0  
JOULES



3 mode

**Efficient brushless DC motor provides higher productivity**

- Excellent maneuverability achieved by in-line grip and ideal gravity point close to handle for easy machine thrust.
- Versatile 3-Mode operation - Hammering, Hammering with rotation and Rotation.
- Unique rubber joint construction to suppress the transmission of vibration.
- Can be attached with the dust extraction system DX01Part no: 195897-1(optional).

<b>Impact Energy</b>	2.0 J (EPTA)
<b>Capacity</b>	Concrete: 24 mm / Steel: 13 mm / Wood: 27 mm
<b>Impacts Per Minute (IPM)</b>	0-4,700
<b>No Load Speed (RPM)</b>	0-950
<b>Sound Pressure Level</b>	90 dB(A)
<b>Sound Power Level</b>	101 dB(A)
<b>Vibration Level</b>	Hammer Drilling Into Concrete: 13.5 m/s <sup>2</sup> Chiseling: 10.5 m/s <sup>2</sup> / Drilling: 3.5 m/s <sup>2</sup>
<b>Dimensions (L x W x H)</b>	328x85x213mm
<b>Net weight</b>	2.6 kg (without battery)

**Standard Equipment:** Depth Gauge, Side Grip. (Tool does not come with bit.)

AVAILABLE VARIANTS

6.0Ah	5.0Ah	3.0Ah	"Z" VARIANT
<b>DHR242 RGJ</b> INCLUDES 2 BATTERIES / 1 CHARGER / MAKPAC CONNECTOR CASE	<b>DHR242 RTJ</b> INCLUDES 2 BATTERIES / 1 CHARGER / MAKPAC CONNECTOR CASE	<b>DHR242 RFJ</b> INCLUDES 2 BATTERIES / 1 CHARGER / MAKPAC CONNECTOR CASE	<b>DHR242 Z</b> TOOL ONLY (DOES NOT INCLUDE BATTERY / CHARGER / CARRYING CASE)

DHR202 20mm 18V LXT

**Cordless Combination Hammer (SDS-PLUS)**



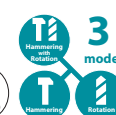

2.0  
JOULES



3 mode

**High operation efficiency with high torque**

- Versatile 3-Mode operation - Hammering, Hammering with rotation and Rotation.
- Unique rubber joint construction to suppress the transmission of vibration.
- Torque limiter operates to stop when drill bits hit against reinforcements.
- LED job light with afterglow function.
- Rubberized soft grip provides more and control and comfort.

<b>Impact Energy</b>	2.0 J (EPTA)
<b>Capacity</b>	Concrete : 20mm Steel : 13mm Wood : 26mm
<b>Blows per minute</b>	0-4,000 bpm
<b>No load speed</b>	0-1,100 rpm
<b>Dimensions (L x W x H)</b>	358 x 84 x 259mm
<b>Net weight</b>	2.8 kg (without battery)

**Standard Equipment:** Depth Gauge, Side Grip. (Tool does not come with bit.)

AVAILABLE VARIANTS

5.0Ah	3.0Ah
<b>DHR202 RTJ</b> INCLUDES 2 BATTERIES / 1 CHARGER / MAKPAC CONNECTOR CASE	<b>DHR202 RFJ</b> INCLUDES 2 BATTERIES / 1 CHARGER / MAKPAC CASE

**DHR182** 18mm 18V | **LXT**

**Cordless Combination Hammer with dust extractor (SDS-PLUS)**



1.7  
JOULES

  
3  
mode

**The Lightest Combination Hammer with Dust Collection system**

- Compact and lightweight for reduced operator fatigue  
With Dust Extract System DX05 Part # 199658-1



Impact Energy	1.7 J (EPTA)
Capacity	Concrete: 18 mm / Steel: 13 mm / Wood: 24 mm
Blows Per Minute (BPM)	0 - 5,000
No Load Speed (RPM)	0 - 1,350
Vibration Level	Hammer Drilling into Concrete: 11.0 m/s <sup>2</sup> Drilling Into Metal: 2.5 m/s <sup>2</sup> or less
Sound pressure Level	89 dB(A)
Sound power Level	100 dB(A)
Dimensions (L x W x H)	301x82x285 mm
Net weight	2.5 kg (with Dust Extractor) (without battery)

**Standard Equipment:** Dust Cup, Side Grip, Depth Gauge, (Tool does not come with bit.)

**AVAILABLE VARIANTS**

**"Z" VARIANT**

**DHR182 ZWJU**  
DUST EXTRACTION SYSTEM DX15, BLUETOOTH CHIP, MAKPAC CASE  
(DOES NOT INCLUDE BATTERY / CHARGER)

**DHR183** 18mm 18V | **LXT**

**Cordless Rotary Hammer with dust extractor (SDS-PLUS)**



1.7  
JOULES

  
2  
mode

**Extremely Compact and Lightweight with Dust Collection system**

- With Anti vibration feature and vibration absorbing housing and ergonomic soft rubber grip design for vibration absorption and comfortable operation
- BL motor with high power to weight and size ratio
- With Dust Extract System DX16 Part # 1911P2-6



Impact Energy	1.7 J (EPTA)
Capacity	Concrete: 18 mm / Steel: 13 mm / Wood: 24 mm
Blows Per Minute (BPM)	0 - 5,000
No Load Speed (RPM)	0 - 1,100
Dimensions (L x W x H)	288 x 89 x 216 mm
Net weight	2.2 kg (with Dust Extractor) (without battery)

**Standard Equipment:** Side Grip, Depth Gauge, (Tool does not come with bit.)

**AVAILABLE VARIANTS**

5.0Ah	"Z" VARIANT
<b>DHR183 RTWJ</b> DUST COLLECTION SYSTEM DX16 2 BATTERIES / 1 CHARGER / MAKPAC CONNECTOR CASE	<b>DHR183 Z</b> TOOL ONLY (DOES NOT INCLUDE BATTERY / CHARGER / MAKPAC CASE / DUST COLLECTION SYSTEM)

**DHR171** 17mm 18V | **LXT**

**Cordless Rotary Hammer (SDS-PLUS)**



1.2  
JOULES

  
2  
mode

**Extremely Compact and Lightweight for increased maneuverability**

- Vibration absorbing housing and ergonomic soft rubber grip design for vibration absorption and comfortable operation
- BL motor with high power to weight and size ratio



Impact Energy	1.2 J (EPTA)
Capacity	Concrete: 17 mm / Steel: 10 mm / Wood: 13 mm
Blows Per Minute (BPM)	0 - 4,800
No Load Speed (RPM)	0 - 680
Vibration Level	Hammer Drilling Into Concrete: 9.0 m/s <sup>2</sup> Drilling Into Metal: 2.5 m/s <sup>2</sup> or less
Sound Pressure Level	86 dB(A)
Sound Power Level	97 dB(A)
Dimensions (L x W x H)	273x86x211 mm
Net weight	2.1 kg (without battery)

**Standard Equipment:** Side Grip, Depth Gauge (Tool does not come with bit.)

**AVAILABLE VARIANTS**

3.0Ah	"Z" VARIANT
<b>DHR171 RFJ</b> INCLUDES 2 BATTERIES / 1 CHARGER / MAKPAC CONNECTOR CASE	<b>DHR171 Z</b> TOOL ONLY (DOES NOT INCLUDE BATTERY / CHARGER / CARRYING CASE)

**HR166D** 16mm 12V MAX | **CXT**

**Cordless Rotary Hammer (SDS-PLUS)**





1.1  
JOULES

  
2  
mode

**Compact, lightweight "palm-size" design Rotary Hammer for ultimate usability: Suitable for upward and horizontal applications**

- Vibration absorbing housing and ergonomic soft rubber grip design for vibration absorption and comfortable operation
- Close-to-hand gravity center for optimum balance and control
- High-efficiency drilling: Provides up to 50% more runtime, up to 40% more speed
- 1.1 Joules impact energy delivers high performance

Impact Energy	1.0 J (EPTA)
Capacity	Concrete: 14 mm / Steel: 10 mm / Wood: 13 mm
Impacts Per Minute (IPM)	0 - 4,900
No Load Speed (RPM)	0 - 850
Vibration Level	Hammer Drilling Into Concrete: 6.5 m/s <sup>2</sup> Drilling Into Metal: 3.0 m/s <sup>2</sup> or less
Dimensions (L x W x H)	246x74x179 mm (with BL1021B)
Net weight	1.6 kg (without battery)

**Standard Equipment:** Side Grip, Depth Gauge

**AVAILABLE VARIANTS**

2.0Ah	"Z" Version
<b>HR166D WAJ</b> INCLUDES 2 BATTERIES / 1 CHARGER / CARRYING CASE	<b>HR166D Z</b> TOOL ONLY (DOES NOT INCLUDE BATTERY / CHARGER OR CARRY CASE)

- DRILLING / FIXING
- CONCRETE DRILLING / DEMOLITION
- MIXING / STIRRING
- CUTTING (CONCRETE / METAL)
- GRINDING
- SANDING / POLISHING
- SAWING
- MULTI-TOOL
- ROUTERS / PLANERS
- NAILERS / STAPLERS
- HEAT GUN / LASER
- CLEANING
- OPE
- JBSITE TOOLS
- SPECIALTY TOOLS
- HAND TOOLS / COMBINATION SET
- TOOL HOLDERS AND POUCHES / MAKPAC SYSTEM

## Compatibility list between AC Hammers and Drill Bits

Capacity	Bit	Model No.	Power	Joules	Kg	0 5 10 15 20 25 30 40 50 60 70 80 90 100 110 120 130 140 150 160																			
						Scale for bit size compatibility (mm)																			
18 mm		HR1841F	470W	1.4J	2.5kg	3.2-18		3.2-10		35		Diamond Core Bit (Dry Type): 32~65 mm													
20 mm		HR2020	710W	2.2J	2.3kg	3.4-20		4-12		35-54		Diamond Core Bit (Dry Type): 32~65 mm													
24 mm		HR2475	780W	2.7J	3.0kg	3.2-24		4-16		35-54		Diamond Core Bit (Dry Type): 32~65 mm													
26 mm		HR2630 / HR2631F / HR2630T / HR2631FT	800W	2.9J	2.8- 3.0kg	3.2-26		4-18		35-68		Diamond Core Bit (Dry Type): 32~80 mm													
26 mm		HR2600 /	800W	2.9J	2.8- 3.0kg	3.2-26		4-18		35-68		Diamond Core Bit (Dry Type): 32~80 mm													
26 mm		HR2661 HR2663	800W	2.9J	3.3- 4.4kg	3.2-26		4-18		35-68		Diamond Core Bit (Dry Type): 32~80 mm													
28 mm		HR2810	800W	2.9J	3.2kg	3.2-28		6-20		35-80		Diamond Core Bit (Dry Type): 32~80 mm													
30 mm		HR3011FC / HR3012FC	1050W	3.9J	4.7kg	6-30		8-22		35-80		Diamond Core Bit (Dry Type): 32~80 mm													
32 mm		HR3210C / /HR3200C	850W	5.5J	4.8kg/ 5.2kg	4-32		10-20		35-90		Diamond Core Bit (Dry Type): 32~90 mm													
35 mm		HR3530	1010W	6.2J	5.8kg	10-35		12-25		25-105															
35 mm		HR3541FC	850W	6.3J	5.6kg	10-35		10-22		25-90															
40 mm		HR4030C	1100W	9.2J	5.6kg	10-40		22-35		25-118															
40 mm		HR4013C / HR4003C	1100W	11.4J	6.8kg/ 6.2kg	10-40		16-35		20-105															
45 mm		HR4511C / HR4501C	1350W	12.5J	8.5kg/ 8.2kg	10-45		22-40		20-125															
52 mm		HR5212C / HR5202C	1510W	21J	11.9kg/ 10.9kg	19-52		25-45		20-160															

Adapted for SDS-MAX bits  
 Adapted for SDS-PLUS bits

Compatible size range of TCT Drill Bit  
 Recommended size range of Drill Bit  
 Compatible size range of Core Bit

**HR1841F 18mm** 

**Rotary Hammer (SDS-PLUS)**



**1.4 JOULES**

**First in the Class 18mm Rotary Hammer Equipped with AVT**

- Anti-Vibration Technology (AVT) for best-in-class low vibration
- Compact AVT is our unique mechanism developed especially for small rotary hammers
- Compact with less weight



Continuous rating input	470W
Impact Energy	1.4 J
Capacity	Concrete: 18 mm Core Bit: 35 mm / Diamond Core Bit (Dry Type): 65 mm Steel: 13 mm / Wood: 24 mm
Blows Per Minute (BPM)	0 - 4,800
No Load Speed (RPM)	0 - 2,100
Sound Pressure Level	87 dB(A)
Sound Power Level	98 dB(A)
Vibration Level	Hammer Drilling Into Concrete: 7.5 m/s <sup>2</sup>
Dimensions (L x W x H)	285x75x208 mm
Net weight	2.5 kg
Power supply cord	2.5 m

**Standard Equipment:** Side Grip, Depth Gauge (Tool does not come with bit.)

**HR2010 20mm** 

**Rotary Hammer (SDS-PLUS)**



**1.7 JOULES**

**Compact, yet tough and durable.**

- Easy bit change with one-touch slide chuck.
- Torque limiting clutch disengages if bit jams.



Continuous rating Input	600W
Capacity	Concrete : 20mm (13/16") Steel : 13mm (1/2") Wood : 24mm (15/16")
Impacts per minute	0-4,000ipm
No load speed	0-900rpm
Sound pressure level	86dB(A)
Sound power level	97dB(A)
Overall length	302mm
Net weight	3.4kg
Power supply cord	5.0m

**Standard Equipment:** Depth Gauge, Grip (Tool does not come with bit.)

**HR2020 20mm** 

**Rotary Hammer (SDS-PLUS)**



**2.2 JOULES**

**Simple and solid construction, yet powerful performance.**

- 2 operation modes -hammering with rotation and rotation only.
- Variable speed + reversible rotation.



Continuous rating Input	710W
Capacity	Concrete : 20mm (3/4") Steel : 13mm (1/2") Wood : 32mm (1-1/4")
Impacts per minute	0-4,050 ipm
No load speed	0-1,050rpm
Sound pressure level	86dB(A)
Sound power level	97dB(A)
Overall length	352mm (13-7/8")
Net weight	2.3kg (5.1lbs)
Power supply cord	4.0m (13.1ft)

**Standard Equipment:** Depth Gauge, Grip. (Tool does not come with bit)

**HR2475 24mm** 

**Combination Hammer (SDS-PLUS)**



**2.7 JOULES**

**High durability in mechanical parts, motor and carbon brush.**

- 3 operation modes - hammering, hammering with rotation, and rotation only.
- Ergonomic D-shaped handle with rubberized soft grip provides more comfort and better control while minimizing hand fatigue and pain.
- One-touch sliding chuck for easy bit changes.



Continuous rating input	780W
Capacity	Concrete : 24mm (15/16") Steel : 13mm (1/2") Wood : 32mm (1-1/4")
Impacts per minute (ipm)	0-4,500
No load speed (rpm)	0-1,100
Sound pressure level	89dB(A)
Sound power level	100dB(A)
Vibration level	Chiseling: 10.5m/s <sup>2</sup> / hammer drilling: 15.5m/s <sup>2</sup> Drilling: 3m/s <sup>2</sup>
Dimensions (L x W x H)	429x84x158mm (16-7/8"x3-5/16"x6-1/4")
Net weight	3.0kg (6.6lbs)
Power supply cord	4.0m (13.1ft)

**Standard Equipment:** Side Handle, Depth Gauge. (Tool does not come with bit)

- DRILLING / FIXING
- CONCRETE DRILLING / DEMOLITION
- MIXING / STIRRING
- CUTTING (CONCRETE / METAL)
- GRINDING
- SANDING / POLISHING
- SAWING
- MULTI-TOOL
- ROUTERS / PLANERS
- NAILERS / STAPLERS
- HEAT GUN / LASER
- CLEANING
- OPE
- JOB SITE TOOLS
- SPECIALTY TOOLS
- HAND TOOLS / COMBINATION SET
- TOOL HOLDERS AND POUCHES / MAKPAC SYSTEM

DRILLING / FIXING

CONCRETE DRILLING / DEMOLITION

MIXING / STIRRING

CUTTING (CONCRETE / METAL)

GRINDING

SANDING / POLISHING

SAWING

MULTI-TOOL

**HR2600 26mm** 

**Rotary Hammer (SDS-PLUS)**



**2.9 JOULES**

**2 Operation Modes: Hammering with rotation & Rotation only.**

- Reverse function on brush holder.
- Large trigger switch.

 **325mm**

Continuous rating input	800W
Capacity	Concrete : 26mm (1") Steel : 13mm (1/2") Wood : 32mm (1-1/4")
Impacts per minute (ipm)	0 - 4,600
No load speed (rpm)	0 - 1,200
Sound pressure level	91dB(A)
Sound power level	102dB(A)
Vibration level	Hammer drilling: 15.5m/s <sup>2</sup> / Drilling: 2.5m/s <sup>2</sup>
Dimensions (L x W x H)	361x77x209mm (14-1/4"x3"x8-1/4")
Net weight	2.8kg (6.2lbs)
Power supply cord	2.5m (8.2ft)

**Standard Equipment:** Side Grip, Depth Gauge. (Tool does not come with bit)

**HR2630 26mm** 

**Combination Hammer (SDS-PLUS)**



**2.9 JOULES**

**Easy-to-grip handle ergonomically designed to give maximum power thrust.**

- 3 operation modes - hammering, hammering with rotation, rotation.
- Less bit wobbling.
- One-touch sliding chuck for easy bit change.
- Operation mode change lever positioned on the bottom of gear housing for reduced possibility of breakage.

 **325mm**

Continuous rating input	800W
Capacity	Concrete : 26mm (1") Steel : 13mm (1/2") Wood : 32mm (1-1/4")
Impacts per minute (ipm)	0-4,600
No load speed (rpm)	0-1,200
Sound pressure level	91dB(A)
Sound power level	102dB(A)
Vibration level	Hammer drilling: 15.5m/s <sup>2</sup> / Chiseling: 9.5m/s <sup>2</sup> Drilling: 2.5m/s <sup>2</sup>
Dimensions (L x W x H)	361x77x209mm (14-1/4"x3"x8-1/4")
Net weight	2.8kg (6.2lbs)
Power supply cord	2.5m (8.2ft)

**Standard Equipment:** Side Grip, Depth Gauge. (Tool does not come with bit)

ROUTERS / PLANERS

NAILERS / STAPLERS

HEAT GUN / LASER

CLEANING

OPE

JOBSITE TOOLS

SPECIALTY TOOLS

HAND TOOLS / COMBINATION SET

TOOL HOLDERS AND POUCHES / MAKPAC SYSTEM

**HR2630X7 26mm** 

**Combination Hammer (SDS-PLUS)**



**2.9 JOULES**

**Includes:**  
3 Jaw Keyless drill chuck assembly

**Easy-to-grip handle ergonomically designed to give maximum power thrust.**

- 3 operation modes - hammering, hammering with rotation, rotation.
- Less bit wobbling.
- One-touch sliding chuck for easy bit change.
- Operation mode change lever positioned on the bottom of gear housing for reduced possibility of breakage.

 **325mm**

Continuous rating input	800W
Capacity	Concrete : 26mm (1") Steel : 13mm (1/2") Wood : 32mm (1-1/4")
Impacts per minute (ipm)	0-4,600
No load speed (rpm)	0-1,200
Sound pressure level	91dB(A)
Sound power level	102dB(A)
Vibration level	Hammer drilling: 15.5m/s <sup>2</sup> / Chiseling: 9.5m/s <sup>2</sup> Drilling: 2.5m/s <sup>2</sup>
Dimensions (L x W x H)	361x77x209mm (14-1/4"x3"x8-1/4")
Net weight	2.8kg (6.2lbs)
Power supply cord	2.5m (8.2ft)

**Standard Equipment:** Side Grip, Depth Gauge. (Tool does not come with bit)

**HR2630T 26mm** 

**Combination Hammer (SDS-PLUS)**



**2.9 JOULES**

**Easy-to-grip handle ergonomically designed to give maximum power thrust**

- 3 operation modes - hammering, hammering with rotation, rotation.
- Less bit wobbling.
- One-touch sliding chuck for easy bit change. (Quick change drill chuck from SDS-plus to 3 jaw chuck literally in a second)
- Operation mode change lever positioned on the bottom of gear housing for reduced possibility of breakage.

 **325mm**

Continuous rating input	800W
Capacity	Concrete : 26mm (1") Steel : 13mm (1/2") Wood : 32mm (1-1/4")
Impacts per minute (ipm)	0-4,600
No load speed (rpm)	0-1,200
Sound pressure level	91dB(A)
Sound power level	102dB(A)
Vibration level	Hammer drilling: 15m/s <sup>2</sup> / Chiseling: 9.5m/s <sup>2</sup> Drilling: 2.5m/s <sup>2</sup>
Dimensions (L x W x H)	385x77x209mm (15-1/8"x3"x8-1/4")
Net weight	3.0kg (6.6lbs)
Power supply cord	2.5m (8.2ft)

**Standard Equipment:** Quick change drill chuck, Side grip, Depth gauge (Tool does not come with bit)

**HR2631F 26mm**



**Combination Hammer (SDS-PLUS)**

**2.9 JOULES**



**Easy-to-grip handle ergonomically designed to give maximum power thrust.**

- 3 operation modes - hammering, hammering with rotation, rotation.
- Less bit wobbling.
- One-touch sliding chuck for easy bit change.
- Operation mode change lever positioned on the bottom of gear housing for reduced possibility of breakage.
- Features a built-in LED Job Light.



Continuous rating input	800W
Capacity	Concrete : 26mm (1") Steel : 13mm (1/2") Wood : 32mm (1-1/4")
Impacts per minute (ipm)	0 - 4,600
No load speed (rpm)	0 - 1,200
Sound pressure level	90dB(A)
Sound power level	101dB(A)
Vibration level	Hammer drilling: 12m/s <sup>2</sup> Chiseling: 9m/s <sup>2</sup> / Drilling: 2.5m/s <sup>2</sup>
Dimensions (L x W x H)	361x77x209mm (14-1/4"x3"x8-1/4")
Net weight	2.9kg (6.4lbs)
Power supply cord	2.5m (8.2ft)

**Standard Equipment:** Side Grip, Depth Gauge. (Tool does not come with bit)

**HR2631FT 26mm**



**Combination Hammer (SDS-PLUS)**

**2.9 JOULES**



**3 Operation Modes: Hammering, Hammering with Rotation, and Rotation only.**

- Less bit wobbling.
- One-touch sliding chuck for easy bit change.
- Operation mode change lever positioned on the bottom of gear housing for reduced possibility of breakage.
- Features a built-in LED Job Light.



Continuous rating input	800W
Capacity	Concrete : 26mm (1") Steel : 13mm (1/2") Wood : 32mm (1-1/4")
Impacts per minute (ipm)	0 - 4,600
No load speed (rpm)	0 - 1,200
Sound pressure level	90dB(A)
Sound power level	101dB(A)
Vibration level	Hammer drilling: 12m/s <sup>2</sup> Chiseling: 9m/s <sup>2</sup> / Drilling: 2.5m/s <sup>2</sup>
Dimensions (L x W x H)	361x77x209mm (14-1/4"x3"x8-1/4")
Net weight	2.9kg (6.4lbs)
Power supply cord	2.5m (8.2ft)

**Standard Equipment:** Quick change drill chuck, Side grip, Depth gauge (Tool does not come with bit)

**HR2661 26mm**



**Combination Hammer with Dust Extraction Unit (SDS-PLUS)**

**2.9 JOULES**



**26mm AVT D-Handle Combination Hammer with HEPA Self Dust Collection, SDS-PLUS Bits**

- HEPA Filter Removes Particles with an Efficiency Rating of 99.75%
- Dust collecting port on telescopic guide with a sliding range of 190 mm
- Secure connection between dust case and dust collecting section for less dust leakage
- See-through dust case for easy checking of collected dust amount
- Easy dust case removal for convenient dust disposal and cleaning



Continuous rating input	800W
Capacity	2.9 J Concrete: 26 mm / Core Bit: 68 mm Diamond Core Bit (Dry Type): 80 mm Steel: 13 mm / Wood: 32 mm
Impacts per minute (ipm)	0 - 4,500
No load speed (rpm)	0 - 1,100
Sound pressure level	90 dB(A)
Sound power level	101 dB(A)
Vibration level	Hammer Drilling Into Concrete: 9.5 m/s <sup>2</sup>
Dimensions (L x W x H)	666x89x228 mm
Net weight	4.4 kg
Power supply cord	2.5 m

**Standard Equipment:** Side Grip, Depth Gauge, Sealing Cap (Tool does not come with bit)

**HR2663 26mm**



**Combination Hammer with Dust Extraction Unit (SDS-PLUS)**

**2.9 JOULES**



**26mm AVT D-Handle Combination Hammer with HEPA Self Dust Collection, Filter cleaning Mechanism, SDS-PLUS Bits**

- Filter cleaning mechanism by turning the dial, the dust falls off from the filter
- HEPA Filter Removes Particles with an Efficiency Rating of 99.75%
- Dust collecting port on telescopic guide with a sliding range of 190 mm
- Secure connection between dust case and dust collecting section for less dust leakage. See-through dust case for easy checking of collected dust amount.
- Easy dust case removal for convenient dust disposal and cleaning



Continuous rating Input	800W
Impact Energy	2.9J (EPTA-Procedure: 2.2 J) Concrete: 26 mm (1") Steel: 13 mm (1/2") Wood: 32 mm (1-1/4") Wood (Self-Feed Bit): 32 mm (1-1/4") Masonry: 26 mm (1")
Capacity	1.5 - 13 mm (1/16 - 1/2")
Chuck Capacity	1.5 - 13 mm (1/16 - 1/2")
Blows Per Minute (BPM)	0 - 4,500
No Load Speed (RPM)	0 - 1,100
Dimensions (L x W x H)	666 x 89 x 260 mm (26-1/4 x 3-1/2 x 10-1/4")
Net weight	3.3 - 4.6 kg
Power supply cord	2.5 m (8.2 ft)

**Standard Equipment:** Side Grip, Depth Gauge, Sealing Cap (Tool does not come with bit)

DRILLING / FIXING

CONCRETE DRILLING / DEMOLITION

MIXING / STIRRING

CUTTING (CONCRETE / METAL)

GRINDING

SANDING / POLISHING

SAWING

MULTI-TOOL

ROUTERS / PLANERS

NAILERS / STAPLERS

HEAT GUN / LASER

CLEANING

OPE

JOBSITE TOOLS

SPECIALTY TOOLS

HAND TOOLS / COMBINATION SET

TOOL HOLDERS AND POUCHES / MAKPAC SYSTEM

DRILLING / FIXING

**HR2810** 28mm



**Combination Hammer**



**2.9**  
JOULES

**3 Operation Modes: Hammering, Hammering with Rotation and Rotation only.**

- Highest-in-class efficiency in both drilling and chipping.
- Compact L-shaped motor housing.
- One-touch sliding chuck enables easy bit changes.
- Ergonomically designed handle with rubberized grip provides more control and comfort.



<b>Continuous rating input</b>	800W
<b>Capacity</b>	Concrete (with T.C.T. bit) : 28mm (1-1/8") Steel : 13mm (1/2") Wood : 32mm (1-1/4")
<b>Impacts per minute (ipm)</b>	0-4,500
<b>No load speed (rpm)</b>	0-1,100
<b>Sound pressure level</b>	89dB(A)
<b>Sound power level</b>	100dB(A)
<b>Vibration level</b>	Chiseling: 15.5m/s <sup>2</sup> , Hammer drilling: 20m/s <sup>2</sup> Drilling: 2.5m/s <sup>2</sup>
<b>Dimensions (L x W x H)</b>	314x89x225mm (12-3/8"x3-1/2"x8-7/8")
<b>Net weight</b>	3.2kg (7.1lbs)
<b>Power supply cord</b>	2.5m (8.2ft)

**Standard Equipment:** Side Grip, Depth Gauge. (Tool does not come with bit)

CONCRETE DRILLING / DEMOLITION

MIXING / STIRRING

CUTTING (CONCRETE / METAL)

GRINDING

SANDING / POLISHING

SAWING

MULTI-TOOL

ROUTERS / PLANERS

NAILERS / STAPLERS

HEAT GUN / LASER

CLEANING

OPE

JOBSITE TOOLS

SPECIALTY TOOLS

HAND TOOLS / COMBINATION SET

TOOL HOLDERS AND POUCHES / MAKPAC SYSTEM

**HR3011FCWJ** 30mm



**Combination Hammer with Dust Extraction Unit (SDS-PLUS)**



**3.9**  
JOULES

**Superior drilling efficiency**

- The impact energy is drastically increased from that of Predecessor model by redesigned hammering mechanism
- Less bit wobbling achieved by 8mm longer bit guide portion
- Equipped with Anti Vibration Technology for low vibration with Anti-vibration side grip and Anti-vibration rear handle
- Dust Extraction System (DX10) with HEPA filter and Filter cleaning mechanism
- Dust collection is available for bits with an overall length of up to 265mm



<b>Continuous rating Input</b>	1,050W
<b>Impact Energy</b>	EPTA-Procedure : 3.9 J
<b>Capacity</b>	Concrete (w/ TCT Bit) : 30 mm (1-3/16") Concrete (w/ Diamond Core Bit) : 80 mm (3-1/8") Steel : 13 mm (1/2") Wood : 32 mm (1-1/4") Wood (Self-Feed Bit) : 32 mm (1-1/4") Masonry : 30 mm (1-3/16")
<b>Chuck Capacity</b>	1.5 - 13 mm (1/16 - 1/2")
<b>Blows Per Minute (BPM)</b>	0 - 4,500
<b>No Load Speed (RPM)</b>	0 - 840
<b>Dimensions (L x W x H)</b>	369 x 98 x 242 mm
<b>Net weight</b>	4.7 kg
<b>Power supply cord</b>	4.0 m

**Standard Equipment:** Side handle, Depth gauge (Tool does not comes with bit.)

**HR3012FCWJ** 30mm



**Combination Hammer with Dust Extraction Unit (SDS-PLUS)**



With Quick change drill chuck

**3.9**  
JOULES

**Superior drilling efficiency**

- The impact energy is drastically increased from that of Predecessor model by redesigned hammering mechanism
- Less bit wobbling achieved by 8mm longer bit guide portion
- Equipped with Anti Vibration Technology for low vibration with Anti-vibration side grip and Anti-vibration rear handle
- Dust Extraction System (DX11) with HEPA filter and Filter cleaning mechanism
- Dust collection is available for bits with an overall length of up to 265mm



<b>Continuous rating Input</b>	1,050W
<b>Impact Energy</b>	EPTA-Procedure: 3.9 J
<b>Capacity</b>	Concrete (w/ TCT Bit) : 30 mm (1-3/16") Concrete (w/ Diamond Core Bit) : 80 mm (3-1/8") Steel : 13 mm (1/2") Wood : 32 mm (1-1/4") Wood (Self-Feed Bit) : 32 mm (1-1/4") Masonry : 30 mm (1-3/16")
<b>Chuck Capacity</b>	1.5 - 13 mm
<b>Blows Per Minute (BPM)</b>	0 - 4,500
<b>No Load Speed (RPM)</b>	0 - 840
<b>Dimensions (L x W x H)</b>	386 x 98 x 242 mm
<b>Net weight</b>	4.7 kg
<b>Power supply cord</b>	4.0 m

**Standard Equipment:** Side handle, Depth gauge (Tool does not comes with bit.)

**HR3200C** 32mm



**Combination Hammer (SDS-PLUS)**



**5.5**  
JOULES

**Developed as the successor model of HR3000C**

- Simple Single-Lever Control to change the tool's operation mode.
- One-Touch sliding chuck for easy bit changes.
- Increased Repairability - with simplified wiring and bit holding mechanism.



<b>Continuous rating input</b>	850W
<b>Capacity</b>	Concrete (with T.C.T. bit) : 32mm (1-1/4") Steel : 13mm (1/2") Wood : 32mm (1-1/4")
<b>Impacts per minute (ipm)</b>	1,650-3,300
<b>No load speed (rpm)</b>	315-630
<b>Sound pressure level</b>	89dB(A)
<b>Sound power level</b>	100dB(A)
<b>Vibration level</b>	Hammer drilling: 18m/s <sup>2</sup> , Chiseling: 12.5m/s <sup>2</sup> Drilling: 2.5m/s <sup>2</sup>
<b>Dimensions (L x W x H)</b>	398x108x239mm (15-5/8"x4-1/4"x9-3/8")
<b>Net weight</b>	4.8kg (10.5lbs)
<b>Power supply cord</b>	5.0m (16.4ft)

**Standard Equipment:** Side handle, Depth gauge, Bit grease, Plastic carrying case, Cleaning cloth (Tool does not comes with bit.)



**HR3210C 32mm** 

**Combination Hammer (SDS-PLUS)**



**5.5**  
JOULES

**Featuring low vibration level and lightweight design for optimal efficiency.**

- Simple Single-Lever Control to change the tool's operation mode.
- One-Touch sliding chuck for easy bit changes.
- Increased Repairability - with simplified wiring and bit holding mechanism.



<b>Continuous rating input</b>	850W
<b>Capacity</b>	Concrete (with T.C.T. bit) : 32mm (1-1/4") Steel : 13mm (1/2"), Wood : 32mm (1-1/4") Concrete (with Core bit) : 90mm (3-1/2")
<b>Impacts per minute (ipm)</b>	1,650-3,300
<b>No load speed (rpm)</b>	315-630
<b>Sound pressure level</b>	89dB(A)
<b>Sound power level</b>	100dB(A)
<b>Vibration level</b>	Hammer drilling: 10m/s <sup>2</sup> , Chiseling: 7.5m/s <sup>2</sup> Drilling: 2.5m/s <sup>2</sup>
<b>Dimensions (L x W x H)</b>	398x114x239mm (15-5/8"x4-1/2"x9-3/8")
<b>Net weight</b>	5.2kg (11.4lbs)
<b>Power supply cord</b>	5.0m (16.4ft)

**Standard Equipment:** Side handle, Depth gauge, Bit grease, Cleaning cloth  
(Tool does not come with bit.)

**HR3530 35mm** 

**Rotary Hammer (HEX-SHANK)**



**6.2**  
JOULES

**High work efficiency.**

- Compact and lightweight design.
- No hammering while idling.
- Ergonomically designed handle with rubberized grip provides more control and comfort.
- Auto cut-out Carbon Brush.



<b>Continuous rating input</b>	1,010W
<b>Capacity</b>	Concrete (with Core bit) : 105mm (4-1/8")
<b>Impacts per minute (ipm)</b>	3,100
<b>No load speed (rpm)</b>	760
<b>Sound pressure level</b>	91dB(A)
<b>Sound power level</b>	102dB(A)
<b>Vibration level</b>	Chiseling: 12.5m/s <sup>2</sup> / Hammer drilling: 19.5m/s <sup>2</sup>
<b>Dimensions (L x W x H)</b>	374x100x243mm (14-3/4"x3-15/16"x9-9/16")
<b>Net weight</b>	5.8kg (12.8lbs)
<b>Power supply cord</b>	5.0m (16.4ft)

**Standard Equipment:** Side Grip, Depth gauge (Tool does not come with bit.)

**HR3540C 35mm** 

**Combination Hammer (SDS-MAX)**



**6.3**  
JOULES

**High performance features high work efficiency especially in drilling with large diameter bits.**

- Change lever positioned on the top of the machine for reduced possibility of breakage even if the machine is carelessly kept down to rest.
- One-touch sliding chuck for easy bit changes.
- Constant speed and soft start features by electrical control.
- LED lamp indicates when to replace carbon brush.
- LED lamp is provided as a pilot lamp.



<b>Continuous rating input</b>	850W
<b>Capacity</b>	Concrete (with T.C.T. bit) : 35mm (1-3/8") Steel : 13mm (1/2"), Wood : 32mm (1-1/4") Concrete (with Core bit) : 90mm (3-1/2")
<b>Impacts per minute (ipm)</b>	1,650 - 3,300
<b>No load speed (rpm)</b>	315 - 630
<b>Sound pressure level</b>	93dB(A)
<b>Sound power level</b>	104dB(A)
<b>Vibration level</b>	Chiseling: 12.5m/s <sup>2</sup> / Hammer drilling: 18m/s <sup>2</sup> Drilling: 2.5m/s <sup>2</sup>
<b>Dimensions (L x W x H)</b>	439x108x239mm (17-1/4"x4-1/4"x9-3/8")
<b>Net weight</b>	5.2kg (11.4lbs)
<b>Power supply cord</b>	5.0m (16.4ft)

**Standard Equipment:** Depth Gauge, Side Handle (Bar-shaped), Bit Grease  
(Tool does not come with bit.)

**HR3541FC 35mm** 

**Combination Hammer (SDS-MAX)**



**6.3**  
JOULES

**AVT(Anti-Vibration Technology) ensures extra-low vibration performance.**

- Vibration absorbing handle provides comfortable operation.
- LED Job light with afterglow function.
- Change lever positioned on the top of the machine for reduced possibility of breakage even if the machine is carelessly kept down to rest.
- Constant speed and soft start features by electrical control.
- LED lamp indicates when to replace carbon brush.



<b>Continuous rating input</b>	850W
<b>Capacity</b>	Concrete (with T.C.T. bit) : 35mm (1-3/8") Steel : 13mm (1/2"), Wood : 32mm (1-1/4") Concrete (with Core bit) : 90mm (3-1/4")
<b>Impacts per minute (ipm)</b>	1,650 - 3,300
<b>No load speed (rpm)</b>	315 - 630
<b>Sound pressure level</b>	91dB(A)
<b>Sound power level</b>	102dB(A)
<b>Vibration level</b>	Chiseling: 9m/s <sup>2</sup> / Hammer drilling: 11m/s <sup>2</sup> Drilling: 2.5m/s <sup>2</sup>
<b>Dimensions (L x W x H)</b>	439x114x239mm (17-1/4"x4-1/2"x9-3/8")
<b>Net weight</b>	5.6kg (12.3lbs)
<b>Power supply cord</b>	5.0m (16.4ft)

**Standard Equipment:** Depth Gauge, Side Handle (Bar-shaped), Bit Grease  
(Tool does not come with bit.)

DRILLING / FIXING

CONCRETE DRILLING / DEMOLITION

MIXING / STIRRING

CUTTING (CONCRETE / METAL)

GRINDING

SANDING / POLISHING

SAWING

MULTI-TOOL

ROUTERS / PLANERS

NAILERS / STAPLERS

HEAT GUN / LASER

CLEANING

OPE

JOBSITE TOOLS

SPECIALTY TOOLS

HAND TOOLS / COMBINATION SET

TOOL HOLDERS AND POUCHES / MAKPAC SYSTEM

- DRILLING / FIXING
- CONCRETE DRILLING / DEMOLITION
- MIXING / STIRRING
- CUTTING (CONCRETE / METAL)
- GRINDING
- SANDING / POLISHING
- SAWING
- MULTI-TOOL
- ROUTERS / PLANERS
- NAILERS / STAPLERS
- HEAT GUN / LASER
- CLEANING
- OPE
- JOBSITE TOOLS
- SPECIALTY TOOLS
- HAND TOOLS / COMBINATION SET
- TOOL HOLDERS AND POUCHES / MAKPAC SYSTEM

**HR4003C 40mm** 

**Rotary Hammer (SDS-MAX)**



**11.4 JOULES**

**Most powerful and efficient in the class**

- New "Two on/off switches switchable in hammering mode".
- Easy-to-operate operation mode change lever.

 **350mm**

Continuous rating input	1,100W
Capacity	Concrete (with T.C.T. bit) : 40mm (1-9/16") Concrete (with Core bit) : 105mm (4-1/8")
Impacts per minute (ipm)	1,450 - 2,900
No load speed (rpm)	250-500
Sound pressure level	92dB(A)
Sound power level	103dB(A)
Vibration level	Chiseling: 9m/s <sup>2</sup> / Hammer drilling: 10m/s <sup>2</sup>
Dimensions (L x W x H)	479x106x263mm (18-11/16" x 4-3/16" x 10-3/8")
Net weight	6.2kg (13.8lbs)
Power supply cord	5.0m (16.4ft)

**Standard Equipment:** Depth gauge, Side handle, Bit grease (Tool does not come with bit)

**HR4001C 40mm** 

**Rotary Hammer (SDS-MAX)**



**9.5 JOULES**

**Most powerful and efficient in the class future style hammer from Makita.**

- Achieves most efficient hammer with satisfying powerful performance.
- Selectable-switch feature gives the choice of trigger switch for drilling and lock-on slide switch for demolition for long hours.

 **350mm**

Continuous rating Input	1,100W
Capacity	Concrete (with T.C.T. bit) : 40mm (1-9/16") Concrete (with Core bit) : 105mm (4-1/8")
Impacts per minute (ipm)	1,350-2,750
No load speed (rpm)	235-480
Sound pressure level	90dB(A)
Sound power level	101dB(A)
Vibration level	Chiseling: 10.5m/s <sup>2</sup> / Hammer drilling: 12.5m/s <sup>2</sup>
Dimensions (L x W x H)	468x106x261mm (18-1/2" x 4-3/16" x 10-1/4")
Net weight	5.9kg (13.0lbs)
Power supply cord	5.0m (16.4ft)

**Standard Equipment:** Depth Gauge, Grip Assembly, Grease Vessel (Tool does not come with bit)

**HR4013C 40mm** 

**Rotary Hammer (SDS-MAX)**



**11.4 JOULES**

**AVT ANTI VIBRATION TECHNOLOGY**

**& SOFT NO LOAD**

**ADVANCED Vibration Control**

Extra Comfort with unrivalled low level of vibration

**High efficiency and unrivalled low level of vibration**

- Soft no load function automatically reduces the motor speed during idling to suppress the vibration of the machine body.
- New "Two on/off switches switchable in hammering mode".
- Easy-to-operate operation mode change lever.

**Vibration absorbing housing**

This is the new AVT mechanism advanced from the current "Vibration absorbing handle".

The level of vibration is further reduced by completely separating the machine holding section from the motor/transmission section



**Active dynamic vibration absorber** ensures operation with extremely low vibration. allows tool design with at body sides for better handling.

**Damper spring** absorbs reaction force caused by drill bit at the moment of impact.

 **350mm** **AVT SOFT NO LOAD**

Continuous rating input	1,100W
Capacity	Concrete (with T.C.T. bit) : 40mm (1-9/16") Concrete (with Core bit) : 105mm (4-1/8")
Impacts per minute (ipm)	1,450 - 2,900
No load speed (rpm)	250-500
Sound pressure level	92dB(A)
Sound power level	103dB(A)
Vibration level	Chiseling: 4.5m/s <sup>2</sup> / Hammer drilling: 5m/s <sup>2</sup>
Dimensions (L x W x H)	479x112x263mm (18-11/16" x 4-3/8" x 10-3/8")
Net weight	6.8kg (15.1lbs)
Power supply cord	5.0m (16.4ft)

**Standard Equipment:** Depth gauge, Side handle, Bit grease (Tool does not come with bit)

**HR4030C 40mm**



**Rotary Hammer (HEX SHANK)**



**9.2**  
JOULES

**Make tough jobs easier with electronic control features and compact design. (Hex Shank type)**

- No hammering while idling.
- When drill bit hits against reinforcements, torque limiter operates to stop.
- Aluminum housing provides high quality and toughness.
- Auto cut-out carbon brush.
- Electronic variable speed control dial enables to select speed to job.



Continuous rating input	1,100W
Capacity	Concrete (with T.C.T. bit) : 40mm (1-9/16") Concrete (with Core bit) : 118mm (4-5/8")
Impacts per minute (ipm)	1,300 - 2,600
No load speed (rpm)	230 - 460
Sound pressure level	92dB(A)
Sound power level	103dB(A)
Vibration level	9m/s <sup>2</sup>
Dimensions (L x W x H)	413x107x247mm (16-1/4"x4-1/4"x9-3/4")
Net weight	6.9kg (15.2lbs)
Power supply cord	5.0m (16.4ft)

**Standard Equipment:** Depth Gauge, Side Grip (Tool does not come with bit.)

**HR4501C 45mm**



**Rotary Hammer (SDS-MAX)**



**12.5**  
JOULES

**High performance and durability.**

- 2 operation modes - hammering and hammering with rotation.
- Selectable two on/off switches on demolition mode.
- One-Touch Sliding Chuck enables easy bit change.
- Ergonomically designed handle with rubberized grip provides more control and comfort.



Continuous rating input	1,350W
Capacity	Concrete (with T.C.T. bit) : 45mm (1-3/4") Concrete (with Core bit) : 125mm (5")
Impacts per minute (ipm)	1,250 - 2,750
No load speed (rpm)	130 - 280
Sound pressure level	94dB(A)
Sound power level	105dB(A)
Vibration level	Hammer drilling: 16m/s <sup>2</sup> / Chiseling: 12.5m/s <sup>2</sup>
Dimensions (L x W x H)	458x121x288mm (18"x4-3/4"x11-3/8")
Net weight	8.2kg (18.1lbs)
Power supply cord	5.0m (16.4ft)

**Standard Equipment:** Side Handle(D), Side Grip, Depth Gauge, Grease Vessel (Tool does not come with bit.)

**HR4511C 45mm**



**Rotary Hammer (SDS-MAX)**



**12.5**  
JOULES

**High performance and low vibration. (with Vibration absorbing grip)**

- 2 operation modes - hammering and hammering with rotation.
- AVT (Anti-Vibration Technology) Active Dynamic Vibration Absorber ensures extra-low vibration performance.
- One-Touch Sliding Chuck enables easy bit change.
- Ergonomically designed handle with rubberized grip provides more control and comfort.



Continuous rating input	1,350W
Capacity	Concrete (with T.C.T. bit) : 45mm (1-3/4") Concrete (with Core bit) : 125mm (5")
Impacts per minute (ipm)	1,250 - 2,750
No load speed (rpm)	130 - 280
Sound pressure level	94dB(A)
Sound power level	105dB(A)
Vibration level	Hammer drilling: 7.5m/s <sup>2</sup> / Chiseling: 7.5m/s <sup>2</sup>
Dimensions (L x W x H)	458x136x288mm (18"x5-3/8"x11-3/8")
Net weight	8.5kg (18.7lbs)
Power supply cord	5.0m (16.4ft)

**Standard Equipment:** Side Handle(D), Side Grip, Depth Gauge, Grease Vessel (Tool does not come with bit.)

**HR5202C 52mm**



**Rotary Hammer (SDS-MAX)**



**21**  
JOULES

**High efficiency and unrivalled low level of vibration.**

- 2 operation modes - hammering and hammering with rotation.
- Ergonomically designed handle with rubberized soft grip provides more control and comfort.
- Selectable two on/off switches on demolition mode.
- One-Touch Sliding Chuck enables easy bit change



Continuous rating input	1,510W
Capacity	Concrete (with T.C.T. bit) : 52mm (2") Concrete (with Core bit) : 160mm (6-5/16")
Impacts per minute (ipm)	1,100 - 2,250
No load speed (rpm)	150 - 310
Sound pressure level	99dB(A)
Sound power level	110dB(A)
Vibration level	Chiseling: 10.5m/s <sup>2</sup> / Hammer drilling: 17m/s <sup>2</sup>
Dimensions (L x W x H)	599x134x287mm (23-1/2"x5-1/4"x11-1/4")
Net weight	10.9kg (24.1lbs)
Power supply cord	5.0m (16.4ft)

**Standard Equipment:** Side handle (D), Side grip, Depth gauge, Grease vessel

DRILLING / FIXING

CONCRETE DRILLING / DEMOLITION

MIXING / STIRRING

CUTTING (CONCRETE / METAL)

GRINDING

SANDING / POLISHING

SAWING

MULTI-TOOL

ROUTERS / PLANERS

NAILERS / STAPLERS

HEAT GUN / LASER

CLEANING

OPE

JBSITE TOOLS

SPECIALTY TOOLS

HAND TOOLS / COMBINATION SET

TOOL HOLDERS AND POUCHES / MAKPAC SYSTEM

- DRILLING / FIXING
- CONCRETE DRILLING / DEMOLITION
- MIXING / STIRRING
- CUTTING (CONCRETE / METAL)
- GRINDING
- SANDING / POLISHING
- SAWING
- MULTI-TOOL
- ROUTERS / PLANERS
- NAILERS / STAPLERS
- HEAT GUN / LASER
- CLEANING
- OPE
- JOBSITE TOOLS
- SPECIALTY TOOLS
- HAND TOOLS / COMBINATION SET
- TOOL HOLDERS AND POUCHES / MAKPAC SYSTEM

**HR5212C** 52mm

**Rotary Hammer (SDS-MAX)**



## ADVANCED Vibration Control

Extra Comfort with unrivalled low level of vibration

**High efficiency and unrivalled low level of vibration**

- Soft no load function automatically reduces the motor speed during idling to suppress the vibration of the machine body.
- New "Two on/off switches switchable in hammering mode".
- Easy-to-operate operation mode change lever.

**AVT** *SOFT* *NO LOAD*

21 JOULES

Continuous rating input	1,510W
Capacity	Concrete (with T.C.T. bit) : 52mm (2") Concrete (with Core bit) : 160mm (6-5/16")
Impacts per minute (ipm)	1,100 - 2,250
No load speed (rpm)	150 - 310
Sound pressure level	98dB(A)
Sound power level	109dB(A)
Vibration level	Chiseling: 8m/s <sup>2</sup> / Hammer drilling: 9m/s <sup>2</sup>
Dimensions (L x W x H)	599x140x287mm (23-1/2" x 5-1/2" x 11-1/4")
Net weight	11.9kg (26.2lbs)
Power supply cord	5.0m (16.4ft)

**Standard Equipment:** Side handle (D), Side grip, Depth gauge, Grease vessel

The level of vibration is further reduced by completely separating the machine holding section from the motor/transmission section

**Vibration absorbing housing**

This is the new AVT mechanism advanced from the current "Vibration absorbing handle".

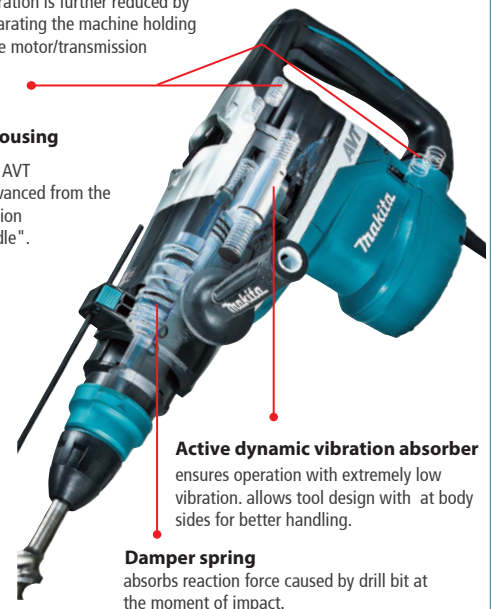

**Active dynamic vibration absorber** ensures operation with extremely low vibration. allows tool design with at body sides for better handling.

**Damper spring** absorbs reaction force caused by drill bit at the moment of impact.

# Demolition Hammers



Models	Weight	Wattage(W) / Voltage(V)	AVT Technology	
			Joules	
HM1101C	7.3kg	1,300W	17J	SDS-MAX
HM1111C	8.0kg	1,300W	17J	<b>AVT</b> SDS-MAX
HM1201	9.1kg	1,130W	14.2J	SDS-MAX
HM1203C	9.7kg	1,510W	25.5J	SDS-MAX
HM1213C	10.8kg	1,510W	25.5J	<b>AVT</b> SDS-MAX
HM1214C	12.3kg	1,500W	26J	<b>AVT</b> SDS-MAX
HM1304	15.5kg	1,500W	25.7J	30mm Hex
HM1306	15.1kg	1,510W	28.8J	30mm Hex
HM1307C	15.3kg	1,510W	33.8J	30mm Hex
HM1317C	17.0kg	1,510W	33.8J	<b>AVT</b> 30mm Hex
HM1511	31.3kg	1,850W	48.9J	<b>AVT</b> 30mm Hex
HM1802	29.4kg	2,000W	71.4J	28.6mm Hex
HM1812	31.3kg	2,000W	72.8J	<b>AVT</b> 28.6mm Hex

HM002G
80V MAX | XGT

**Cordless Demolition Hammer (SDS-MAX)**

20.9J

**Heavy Duty Performance - with the twin battery system, the tool achieves the 80v max power (40V max + 40V max).**

- Combination of XGT system and powerful brushless motor provides high impact energy of 20.9J for faster breaking.
- Low Vibration with Anti-Vibration Technology



Impact Energy	20.9 J (EPTA-Value)
Blows Per Minute (BPM)	950 - 1,900
Shank Diameter	18 mm
Sound Pressure Level	92 dB(A)
Sound Power Level	103 dB(A)
Vibration Level	Chiselling Function w/ Side Handle: 8.0 m/s <sup>2</sup>
Dimensions (L x W x H)	574 x 156 x 344 mm (with 5.0Ah battery)
Net weight	10.7kg (without battery)

**Standard Equipment:** Bit Grease, Side Handle

"Z" VARIANT
AVAILABLE VARIANTS

**HM002G Z**  
TOOL ONLY (WITH CARRY CASE)  
 (DOES NOT INCLUDE BATTERY / CHARGER)

HM001G
40V MAX | XGT

**Cordless Chipping Hammer (SDS-MAX)**

9.4J

**Heavy Duty Performance with Superior Power with 40V max XGT battery**

- Low Vibration with Anti-Vibration Technology
- 5-stage max speed selection



Impact Energy	9.4 J (EPTA-Value)
Blows Per Minute (BPM)	0 - 2,650
No Load Speed (RPM)	18 mm
Sound Pressure Level	89 dB(A)
Sound Power Level	100 dB(A)
Vibration Level	Chiseling Function w/ Side Handle: 6.0 m/s <sup>2</sup> Chiseling Function w/ Side Grip: 5.5 m/s <sup>2</sup>
Dimensions (L x W x H)	496 x 113 x 258 mm (with 4.0Ah battery) 516 x 113 x 280 mm (with 5.0Ah battery)
Net weight	5.6 kg (without battery)

**Standard Equipment:** Bit Grease, Side Handle

"Z" VARIANT
AVAILABLE VARIANTS

**HM001G Z**  
TOOL ONLY (WITH CARRY CASE)  
 (DOES NOT INCLUDE BATTERY / CHARGER)

- DRILLING / FIXING
- CONCRETE DRILLING / DEMOLITION
- MIXING / STIRRING
- CUTTING (CONCRETE / METAL)
- GRINDING
- SANDING / POLISHING
- SAWING
- MULTI-TOOL
- ROUTERS / PLANERS
- NAILERS / STAPLERS
- HEAT GUN / LASER
- CLEANING
- OPE
- JOBSITE TOOLS
- SPECIALTY TOOLS
- HAND TOOLS / COMBINATION SET
- TOOL HOLDERS AND POUCHES / MAKPAC SYSTEM

HM0810T
AG

**Chipping Hammer (17mm HEX-SHANK)**

7.6 JOULES

**Perfect combination of power, durability and compact design.**

- Compact and lightweight for maximum control.
- Soft rubber grip side handle and anti-vibration spring on rear handle for reduced operator fatigue.
- Easy to grip round shape barrel protected by rubber cover.
- One touch sliding chuck for easy bit installation and removal.



Continuous rating input	900W
Impacts per minute (ipm)	2,900
Sound pressure level	92dB(A)
Sound power level	103dB(A)
Vibration level	Chiseling: 14m/s <sup>2</sup>
Overall length	428mm (16-7/8")
Net weight	5.5kg (12.1lbs)
Power supply cord	5.0m (16.4ft)

**Standard Equipment:** Bull Point, Hex Wrench, Grip

HM0871C
AG

**Chipping Hammer (SDS-MAX)**

11.6 JOULES

**AVT (Anti-Vibration Technology) ensures extra-low vibration performance.**

- Soft no load function ensures low vibration performance.
- High durability and excellent demolition performance.
- One touch sliding chuck for easy bit installation and removal.
- LED lamp indicates when to replace carbon brush.
- LED lamp is provided as a pilot lamp.



Continuous rating Input	1,100W
Impacts per minute (ipm)	1,100-2,650 ipm
Sound pressure level	86dB(A)
Sound power level	97dB(A)
Vibration level	Chiseling: 8m/s <sup>2</sup>
Dimensions (L x W x H)	466 x 116 x 230mm (18-3/8" x 4-9/16" x 9")
Vibration	8.4 m/s <sup>2</sup>
Net weight	5.6kg (12.4lbs)
Power supply cord	5.0m (16.4ft)

**Standard Equipment:** Grease for Bit, Side Handle. ( Tool does not come with bull point)

- DRILLING / FIXING
- CONCRETE DRILLING / DEMOLITION
- MIXING / STIRRING
- CUTTING (CONCRETE / METAL)
- GRINDING
- SANDING / POLISHING
- SAWING
- MULTI-TOOL
- ROUTERS / PLANERS
- NAILERS / STAPLERS
- HEAT GUN / LASER
- CLEANING
- OPE
- JOBSITE TOOLS
- SPECIALTY TOOLS
- HAND TOOLS / COMBINATION SET
- TOOL HOLDERS AND POUCHES / MAKPAC SYSTEM

HM0870C
AC

**Chipping Hammer (SDS-MAX)**

11.4  
JOULES



**High durability and excellent demolition performance.**

- One touch sliding chuck for easy bit installation and removal.
- LED lamp indicates when to replace carbon brush.
- LED lamp is provided as a pilot lamp.

350 mm

Continuous rating input	1,100W
Impacts per minute (ipm)	1,100-2,650
Sound pressure level	87dB(A)
Sound power level	98dB(A)
Vibration level	Chiseling: 11.5m/s <sup>2</sup>
Dimensions (L x W x H)	449x109x230mm (17-3/4"x4-1/4"x9")
Net weight	5.1kg (11.1lbs)
Power supply cord	5.0m (16.4ft)

**Standard Equipment:** Grease for Bit, Side Handle. ( Tool does not come with bull point)

HM1101C
AC

**Demolition Hammer (SDS-MAX)**

17  
JOULES



**High durability and excellent demolition performance.**

- One touch sliding chuck for easy bit installation and removal.
- LED lamp indicates when to replace carbon brush.
- LED lamp is provided as a pilot lamp.

175 mm

Continuous rating Input	1,300W
Impacts per minute (ipm)	1,100-2,650
Sound pressure level	90dB(A)
Sound power level	101dB(A)
Vibration level	Chiseling: 13.5m/s <sup>2</sup>
Dimensions (L x W x H)	528 x 115 x 247mm (20-3/4" x 4-1/2" x 9-3/4")
Net weight	7.3kg (16.2lbs)
Power supply cord	5.0m (16.4ft)

**Standard Equipment:** Grease for Bit, Side Handle. ( Tool does not come with bull point)

HM1111C
AC

**Demolition Hammer (SDS-MAX)**

17  
JOULES



**AVT (Anti-Vibration Technology) ensures extra-low vibration performance.**

- Soft no load function ensures low vibration performance.
- High durability and excellent demolition performance.
- One touch sliding chuck for easy bit installation and removal.
- LED lamp indicates when to replace carbon brush.
- LED lamp is provided as a pilot lamp.

175 mm

Continuous rating Input	1,300W
Impacts per minute	1,100-2,650 ipm
Sound pressure level	88dB(A)
Sound power level	99dB(A)
Vibration	Chiseling: 8m/s <sup>2</sup>
Dimensions (L x W x H)	528 x 115 x 247mm (20-3/4" x 4-1/2" x 9-3/4")
Net weight	8.0kg (17.7lbs)
Power supply cord	5.0m (16.4ft)

**Standard Equipment:** Grease for Bit, Side Handle. ( Tool does not come with bull point)

HM1203C
AC

**Demolition Hammer (SDS-MAX)**

25.5  
JOULES



**High durability and excellent demolition performance.**

- One touch sliding chuck for easy bit installation and removal.
- Electronic speed control for maximum performance.
- Bit can be set at 12 positions for convenience.
- LED lamp indicates when to replace carbon brush.

175 mm

Continuous rating Input	1,510W
Impacts per minute	950 - 1,900 ipm
Sound pressure level	81dB(A)
Sound power level	95dB(A)
Vibration level	Chiseling: 16.5m/s <sup>2</sup>
Dimensions (L x W x H)	576 x 128 x 265mm (22-3/4" x 5" x 10-3/8")
Net weight	9.7kg (21.4lbs)
Power supply cord	5.0m (16.4ft)

**Standard Equipment:** Bull Point, Bit Grease, Side Handle.

**HM1213C** 

**Demolition Hammer (SDS-MAX)**



**25.5 JOULES**

**AVT (Anti-Vibration Technology) ensures extra-low vibration performance.**

- Suppression of motor speed during no-load reduces vibration of tool body.
- One touch sliding chuck for easy bit installation and removal.
- Electronic speed control for maximum performance.
- Bit can be set at 12 positions for convenience.
- LED lamp indicates when to replace carbon brush.

 **AVT SOFT NOLOAD 175mm**

Continuous rating Input	1,510W
Impacts per minute	950-1,900 ipm
Sound pressure level	75dB(A)
Sound power level	95dB(A)
Vibration level	Chiseling: 8.0m/s <sup>2</sup>
Dimensions (L x W x H)	576 x 149 x 265mm (22-3/4" x 5-7/8" x 10-3/8")
Net weight	10.8kg (23.6lbs)
Power supply cord	5.0m (16.4ft)

**Standard Equipment:** Bull Point, Bit Grease, Side Handle.

**HM1214C** 

**Demolition Hammer (SDS-MAX)**



**26 JOULES**

**Comfortable operation at hammering downward.**

- AVT (Anti-Vibration Technology) ensures extra-low vibration performance.
- Suppression of motor speed during no-load reduces vibration of tool body.
- Long size carbon brush for service life is extended.
- One touch sliding chuck for easy bit installation and removal.
- LED lamp indicates when to replace carbon brush.

 **AVT SOFT NOLOAD 175mm**

Continuous rating Input	1,510W
Impacts per minute (ipm)	950-1,900
Sound pressure level	78dB(A)
Sound power level	98dB(A)
Vibration level	Chiseling: 8m/s <sup>2</sup>
Dimensions (L x W x H)	700 x 129 x 265mm (27-1/2" x 5-1/8" x 10-3/8")
Net weight	12.3kg (27.1lbs)
Power supply cord	5.0m (16.4ft)

**Standard Equipment:** Bull Point, Bit Grease, Side Handle.

**HM1307C** 

**Demolition Hammer (30mm HEX -SHANK)**



**33.8 JOULES**

**High durability and excellent demolition performance.**

- Electrical speed control for maximum performance.
- LED lamp indicates when to replace carbon brush.
- LED lamp is provided as a pilot lamp.

 **AVT SOFT NOLOAD 175mm**

Continuous rating Input	1,510W
Impacts per minute (ipm)	730-1,450
Sound pressure level	81dB(A)
Sound power level	101dB(A)
Vibration level	Chiseling: 12.5m/s <sup>2</sup>
Dimensions (L x W x H)	715 x 129 x 266mm (28-1/8" x 5-1/8" x 10-1/2")
Net weight	15.3kg (33.8lbs)
Power supply cord	5.0m (16.4ft)

**Standard Equipment:** Side Handle. (Tool does not come with bit)

**HM1317C** 

**Demolition Hammer (30mm HEX -SHANK)**



**33.8 JOULES**

**AVT (Anti-Vibration Technology) ensures extra-low vibration performance.**

- Suppression of motor speed during no-load reduces vibration of tool body.
- High durability and excellent demolition performance.
- Electrical speed control for maximum performance.
- LED lamp indicates when to replace carbon brush.
- LED lamp is provided as a pilot lamp.

 **AVT SOFT NOLOAD 175mm**

Continuous rating Input	1,510W
Impacts per minute	730-1,450 ipm
Sound pressure level	81dB(A)
Sound power level	101dB(A)
Vibration	Chiseling: 8.5m/s <sup>2</sup>
Dimensions (L x W x H)	715 x 129 x 266mm (28-1/8" x 5-1/8" x 10-1/2")
Net weight	17.0kg (37.5lbs)
Power supply cord	5.0m (16.4ft)

**Standard Equipment:** Side Handle. (Tool does not come with bit)

- DRILLING / FIXING
- CONCRETE DRILLING / DEMOLITION
- MIXING / STIRRING
- CUTTING (CONCRETE / METAL)
- GRINDING
- SANDING / POLISHING
- SAWING
- MULTI-TOOL
- ROUTERS / PLANERS
- NAILERS / STAPLERS
- HEAT GUN / LASER
- CLEANING
- OPE
- JOBSITE TOOLS
- SPECIALTY TOOLS
- HAND TOOLS / COMBINATION SET
- TOOL HOLDERS AND POUCHES / MAKPAC SYSTEM

- DRILLING / FIXING
- CONCRETE DRILLING / DEMOLITION
- MIXING / STIRRING
- CUTTING (CONCRETE / METAL)
- GRINDING
- SANDING / POLISHING
- SAWING
- MULTI-TOOL
- ROUTERS / PLANERS
- NAILERS / STAPLERS
- HEAT GUN / LASER
- CLEANING
- OPE
- JOBSITE TOOLS
- SPECIALTY TOOLS
- HAND TOOLS / COMBINATION SET
- TOOL HOLDERS AND POUCHES / MAKPAC SYSTEM

## HM1511

**Electric Breaker (30mm HEX-SHANK)**

**48.9**  
Joules



**Powerful 1,850 W motor delivers 48.9 J (EPTA) of impact energy to handle the most demanding applications**

- Both drastically increased power and low vibration are achieved with minimum increase in tool size and weight
- Thanks to completely redesigned hammering mechanism and increased motor power as compared with HM1317C serie
- L.E.D. service light notifies the user 8 hours (approx) before the brushes need to be replaced and L.E.D. power light indicates switch failure or cord damage
- Rubberized ergonomic soft grip provides more comfort
- Easy-to-operate slide switch increases productivity & allows for continuous use
- Side handle swivels 360° for greater control

Continuous rating Input	1,850W
Impact Energy	EPTA (48.9 J)
Blows Per Minute (BPM)	1,300
Dimensions (L x W x H)	781 x 130 x 266 mm
Net weight	19.2 kg
Power supply cord	4.0 m

**Standard Equipment:** Side Handle. (Tool does not come with bit)

## HM1802

**Electric Breaker (28.6mm HEX-SHANK)**

**71.4**  
Joules



**Highest-in-class demolition power.**

- Vibration absorbing housing helps to reduce vibration.
- Soft start for suppressing start-up reaction.
- Soft grip provides more control and less hand fatigue.
- Higher durability obtained by strengthening switch.
- Newly developed dust extraction attachment is available.

Continuous rating Input	2,000W
Impact energy	71.4J
Impacts per minute (ipm)	870
Sound pressure level	95dB(A)
Sound power level	106dB(A)
Vibration level	14.0m/s <sup>2</sup>
Dimensions (L x W x H)	843x210x608mm (33-1/4"x8-1/4"x24")
Net weight	30.1kg (66.4lbs)
Power supply cord	5.0m (16.4ft)

**Standard Equipment:** Bull point, Hex wrench.

## HM1812

**Electric Breaker (28.6mm HEX-SHANK)**

**72.8**  
Joules



**Highest-in-class demolition power with AVT (Anti-Vibration Technology)**

- Counter weight mechanism and vibration absorbing housing helps to reduce vibration.
- Suppression of motor speed during no-load reduces vibration of tool body when idling.
- Soft start for suppressing start-up reaction.
- Soft grip provides more control and less hand fatigue.

**The first electric breakers from Makita that are equipped with vibration absorbing housing providing a practical combination of high power and low vibration.**

**Soft grip**

**Highly durable switch**

**Improved repairability**

**Electronic control**

- Soft start
- LED light to indicate energization of electric circuit
- LED light to indicate the time to replace carbon brush

**Auto cut-off carbon brush**

**SOFT NO LOAD AVT**  
ANTI VIBRATION TECHNOLOGY

**Advance Vibration Control**

**Recessed hand hold**  
Helps you raise a machine upright for easy transport. Located on the both sides of the machine for convenience

**Vibration absorbing housing**  
Vibration absorbing spring (4 places)

The machine holding section is separated from the motor/transmission section

Continuous rating Input	2,000W
Impact energy	72.8J
Impacts per minute (ipm)	870
Sound pressure level	96dB(A)
Sound power level	108dB(A)
Vibration level	6.5m/s <sup>2</sup>
Dimensions (L x W x H)	843x210x608mm (33-1/4"x8-1/4"x24")
Net weight	32.2kg (70.9lbs)
Power supply cord	5.0m (16.4ft)

**Standard Equipment:** Bull point, Hex wrench.





## POWER SCRAPER

### DHK180

18V | **LXT**

#### Cordless Power Scraper (SDS-PLUS)

**3.1**  
Joules



#### High Power, Low Vibration, Compact and Lightweight Power Scraper

- Anti-vibration housing and AVT for reduced operator fatigue
- BL motor delivers high power
- Compact and lightweight
- Excellent maneuverability
- Twin LED job light



Impact Energy	3.1 J (EPTA)
Blows Per Minute (BPM)	0 - 3,200
Vibration Level	Chiselling: 4.5 m/s <sup>2</sup>
Sound Pressure Level	83 dB(A)
Sound Power Level	94 dB(A)
Dimensions (L x W x H)	368x99x211 mm
Net weight	3.6 kg

#### AVAILABLE VARIANTS

##### "Z" VARIANT

**DHK180 Z**  
TOOL ONLY  
(DOES NOT INCLUDE BATTERY / CHARGER / CARRYING CASE)

DRILLING / FIXING

CONCRETE DRILLING / DEMOLITION

MIXING / STIRRING

CUTTING (CONCRETE / METAL)

GRINDING

SANDING / POLISHING

SAWING

MULTI-TOOL

ROUTERS / PLANERS

NAILERS / STAPLERS

HEAT GUN / LASER

CLEANING

OPE

JOBSITE TOOLS

SPECIALTY TOOLS

HAND TOOLS / COMBINATION SET

TOOL HOLDERS AND POUCHES / MAKPAC SYSTEM

### HK0500



#### Power Scraper (SDS-PLUS)

**2.8**  
Joules



#### For scraping, chiseling and chipping.

- Bit inserts easily; just slide sleeve down to remove.
- 12 different bit angle settings.
- One touch sliding chuck with dust protection.



Continuous rating Input	550W
Impacts per minute	2,000 – 3,500 ipm
Sound pressure level	83dB(A)
Sound power level	94dB(A)
Overall length	468 mm (18-7/16")
Net weight	3.2 kg (7.1 lbs)
Power supply cord	5.0 m (16.4 ft)

Standard Equipment: Scaling Chisel.

### HK1820



#### Power Scraper (SDS-PLUS)

**3.9**  
Joules



#### Quick in removing tiles / concrete scales / weld spatter / old mortar.

- Employs SDS-Plus bit system.
- 12 bit angle settings.
- Lighter than the competing SDS-Plus power scrapers.
- Lowest-in-class vibration (10m/s<sup>2</sup>) ensures more comfort and control.
- Increased reparability of electrical parts.



Continuous rating Input	550W
Impacts per minute	0 - 3,200 ipm
Sound pressure level	83dB(A)
Sound power level	94dB(A)
Vibration	10m/s <sup>2</sup>
Dimensions (L x W x H)	351mm x 102mm x 203 mm (13-3/4" x 4" x 8")
Net weight	3.4 kg (7.5 lbs)
Power supply cord	5.0 m (16.4 ft)

Standard Equipment: Bull Point, Scaling chisel, Scaling chisel, Hook complete.



DRILLING / FIXING

CONCRETE DRILLING / DEMOLITION

MIXING / STIRRING

CUTTING (CONCRETE / METAL)

GRINDING

SANDING / POLISHING

SAWING

MULTI-TOOL

ROUTERS / PLANERS

NAILERS / STAPLERS

HEAT GUN / LASER

CLEANING

OPE

JOBSITE TOOLS

SPECIALTY TOOLS

HAND TOOLS / COMBINATION SET

TOOL HOLDERS AND POUCHES / MAKPAC SYSTEM

# SDS-PLUS DRILL BITS

Adapted for SDS-PLUS Rotary Hammers

## PREMIUM RANGE

### Best in its class

For more productivity and accuracy

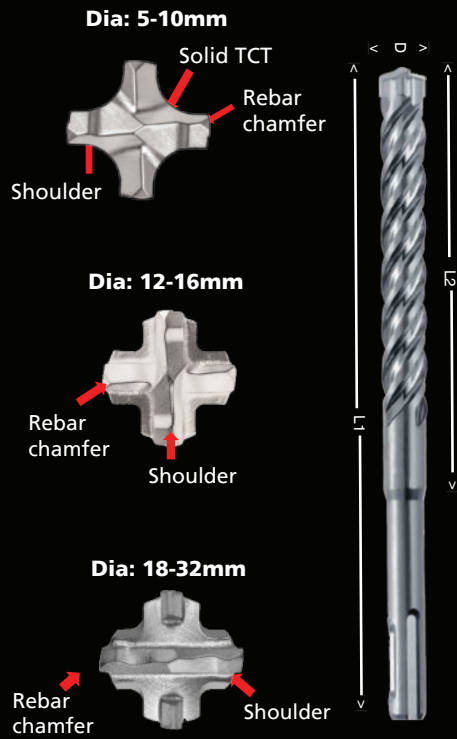

**Solid Type TCT -**  
For maximum impact and torsion forces as well as prolonged service life

**Shorter Entrance -**  
The drilling dust travels quickly from the drill head into the spiral flute

**Rebar Chamfer -**  
Leads to an increased life time and optimum drilling behavior in reinforcement strikes

**Shoulder -**  
Two elevation on the cutting edge, provide improved breaking performance in concrete and optimal reinforcement strength

**Innovated Flute Geometry -**  
the drilling dust is removed faster, while at the same time ensuring low-vibration drilling and a high degree of fracture safety

**Wearing Mark -**  
Wearing mark serves as an indication on the life of the drill bit and a high degree of fracture safety

BIT DIA (D) (MM)	OVERALL LENGTH (L1) (MM)	WORKING LENGTH (L2) (MM)	PER PKG	PART NO (NEW)	PART NO
5	115	50	1	B-57897	-
5	165	100	1	B-57906	-
6	115	50	1	B-57962	-
6	165	100	1	B-57978	-
6	215	150	1	B-57984	-
6	265	200	1	B-57990	-
7	115	50	1	B-58067	B-11754
7	165	100	1	B-58073	-
8	115	50	1	B-58095	-
8	165	100	1	B-58104	-
8	215	150	1	B-58110	-
8	265	200	1	B-58126	-
10	115	50	1	B-58198	-
10	165	100	1	B-58207	-
10	215	150	1	B-58213	-
10	265	200	1	B-58229	-
10	315	250	1	B-58235	-
10	455	390	1	B-58257	-
12	160	110	1	B-58322	-
12	210	160	1	B-58338	-
12	260	210	1	B-58344	-
12	310	260	1	B-58350	-
12	450	400	1	B-58366	-
14	160	110	1	B-58431	-
14	210	160	1	B-58447	-
14	260	210	1	B-58453	-
14	310	260	1	B-58469	-
14	450	400	1	B-58475	-
15	160	110	1	B-58506	B-14205
15	210	160	1	B-58512	B-14211
16	160	110	1	B-58540	-
16	210	160	1	B-58556	-
16	260	210	1	B-58562	-
16	310	260	1	B-58578	-
16	450	400	1	B-58584	-
18	250	200	1	B-58615	-
18	450	400	1	B-58621	-
20	250	200	1	B-58637	-
20	450	400	1	B-58659	-
22	250	200	1	B-58665	-
22	450	400	1	B-58687	-
24	250	200	1	B-58693	B-12108
24	450	400	1	B-58702	-
25	250	200	1	B-58718	-
25	450	400	1	B-58724	-
28	250	200	1	B-58746	-
28	450	400	1	B-58752	B-12158
30	250	200	1	B-58768	B-12164
30	450	400	1	B-58774	B-12170
32	450	400	1	B-58780	-

# SDS-PLUS DRILL BITS



Adapted for  
SDS-PLUS Rotary Hammers

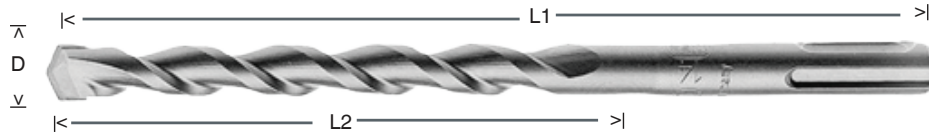

## STANDARD RANGE

- 2 cutter SDS plus drill bits suitable for masonry and concrete.
- The solid carbide tip with centering point and optimized flutes offers fast drilling speeds.

BIT DIA (D) (MM)	OVERALL LENGTH (L1) (MM)	WORKING LENGTH (L2)(MM)	PER PKG	NEW PART NO	PART NO
4.0	110	50	1	D-00016(A)	D-00402
5.0	110	50	1	D-00022(A)	D-00418
5.0	160	100	1	D-00038(A)	-
5.0	210	150	1	-	D-66628
5.5	110	50	1	D-00044(A)	D-00430
6.0	110	50	1	D-00050(A)	-
6.0	160	100	1	D-00066(A)	-
6.0	210	150	1	D-00072(A)	-
6.5	260	200	1	-	-
7.0	110	50	1	D-00103(A)	-
7.0	160	100	1	D-00119(A)	-
8.0	110	50	1	D-00125(A)	-
8.0	160	100	1	D-00131(A)	-
8.0	210	150	1	D-00147(A)	-
8.0	260	200	1	D-00153(A)	-
9.0	160	100	1	D-08056(A)	-
9.0	210	150	1	D-00169(A)	D-00555
10	160	100	1	D-00175(A)	D-00561
10	210	150	1	D-00181(A)	D-00577
10	260	200	1	D-00197(A)	D-00583
10	310	250	1	D-00206(A)	D-00599
10	350	290	1	-	D-66656
11	160	100	1	D-00212(A)	-
11	260	200	1	-	D-66678
12	160	100	1	D-00228(A)	D-00614
12	210	150	1	D-00234(A)	D-00620
12	260	200	1	D-00240(A)	D-00636
12	310	250	1	-	D-66684
12	460	400	1	D-16271	-
13	160	100	1	D-00256(A)	D-00642

BIT DIA (D) (MM)	OVERALL LENGTH (L1) (MM)	WORKING LENGTH (L2)(MM)	PER PKG	NEW PART NO	PART NO
14	160	100	1	D-00262(A)	-
14	260	200	1	D-00278(A)	D-00664
14	310	250	1	-	D-66709
14	460	400	1	D-17544	-
15	160	100	1	D-00284(A)	D-00670
16	210	150	1	D-00290(A)	D-00686
16	310	250	1	D-00309(A)	-
16	460	400	1	-	D-29103
17	210	150	1	D-00315(A)	D-00701
18	210	150	1	D-00321(A)	-
18	300	250	1	D-00337	-
18	460	400	1	D-17566	-
19	210	150	1	D-00739	-
19	460	400	1	D-16293	-
20	210	150	1	D-00359(A)	D-00745
20	310	250	1	D-00365(A)	-
20	460	400	1	D-15235	D-16900
22	260	200	1	D-00371(A)	-
22	310	250	1	D-08062(A)	-
22	460	400	1	D-15241	-
24	460	400	1	D-16302	-
25	260	200	1	D-00387(A)	D-00773
25	310	250	1	D-08517(A)	-
25	460	400	1	D-15257	-
26	260	200	1	D-00393(A)	-
26	460	400	1	D-15263	-
28	460	400	1	D-16318	-
30	460	400	1	D-17572	-

- DRILLING / FIXING
- CONCRETE DRILLING / DEMOLITION
- MIXING / STIRRING
- CUTTING (CONCRETE / METAL)
- GRINDING
- SANDING / POLISHING
- SAWING
- MULTI-TOOL
- ROUTERS / PLANERS
- NAILERS / STAPLERS
- HEAT GUN / LASER
- CLEANING
- OPE
- JOBSITE TOOLS
- SPECIALTY TOOLS
- HAND TOOLS / COMBINATION SET
- TOOL HOLDERS AND POUCHES / MAKPAC SYSTEM

DRILLING /  
FIXING

## 14 pcs SDS-PLUS drill bit

(Assorted) with aluminum case.



Adapted for  
SDS-PLUS Rotary Hammers

CONCRETE  
DRILLING /  
DEMOLITION

MIXING /  
STIRRING

CUTTING  
(CONCRETE /  
METAL)

GRINDING

SANDING /  
POLISHING

SAWING

MULTI-TOOL

ROUTERS /  
PLANERS

NAILERS /  
STAPLERS

HEAT GUN /  
LASER

CLEANING

OPE

JOBSITE  
TOOLS

SPECIALTY  
TOOLS

HAND TOOLS /  
COMBINATION SET

TOOL HOLDERS  
AND POUCHES /  
MAKPAC SYSTEM

## 14 pcs SDS-PLUS drill bit / chisel set

(Assorted) with aluminum case



Adapted for  
SDS-PLUS Rotary Hammers



## 10 pcs SDS-PLUS drill bit

(Assorted) with aluminum case.



Adapted for  
SDS-PLUS Rotary Hammers



Bit Dia (mm)	Overall Length (mm)	Working Length (mm)	Per Pkg	Part No
5	110	42	1	D-21325
6	110	42	1	
6	160	92	1	
7	110	42	1	
7	160	92	1	
8	110	42	1	
8	160	92	1	
10	160	92	1	
10	210	140	1	
12	160	92	1	
12	210	140	1	
14	160	92	1	
14	210	140	1	
16	210	140	1	

Bit Dia (mm)	Overall Length (mm)	Working Length (mm)	Per Pkg	Part No
5	110	42	1	D-71174
6	110	42	1	
6	160	92	1	
7	110	42	1	
7	160	92	1	
8	110	42	1	
8	160	92	1	
10	160	92	1	
12	160	92	1	
14	160	92	1	
16	160	92	1	
SDS-Plus Bull Point (250)			1	
SDS-Plus Cold Chisel (20x250)			1	
Drill Chuck & Chuck Key (13mm Chuck)			1	

Bit Dia (mm)	Overall Length (mm)	Working Length (mm)	Per Pkg	Part No
5	160	92	1	D-71990
6	160	92	1	
8	160	92	1	
10	160	92	1	
10	210	140	1	
12	160	92	1	
12	210	140	1	
16	210	140	1	
SDS-Plus Bull Point (250)			1	
SDS-Plus Cold Chisel (20x250)			1	

## 6 pcs SDS-PLUS drill bit / chisel set

(Assorted)



Adapted for SDS-PLUS Rotary Hammers



Bit Dia (mm)	Overall Length (mm)	Working Length (mm)	Per Pkg	Part No
5	160	100	1	D-58920
6	160	100	1	
8	160	100	1	
Bull Point 250mm			1	
Cold Chisel 20x250mm			1	
Scaling Chisel 40x250mm			1	

DRILLING / FIXING

CONCRETE DRILLING / DEMOLITION

MIXING / STIRRING

CUTTING (CONCRETE / METAL)

GRINDING

SANDING / POLISHING

SAWING

MULTI-TOOL

ROUTERS / PLANERS

NAILERS / STAPLERS

HEAT GUN / LASER

CLEANING

OPE

JOB SITE TOOLS

SPECIALTY TOOLS

HAND TOOLS / COMBINATION SET

TOOL HOLDERS AND POUCHES / MAKPAC SYSTEM

## 4 pcs SDS-PLUS drill bit set

(Assorted) with plastic butterfly case bits can be easily located and removed



Adapted for SDS-PLUS Rotary Hammers



### Set 1

Bit Dia (mm)	Overall Length (mm)	Per Pkg	Part No
5	110	1	D-74136
6	160	1	
8	160	1	
10	160	1	

### Set 2

Bit Dia (mm)	Overall Length (mm)	Per Pkg	Part No
6	160	1	D-74756
8	160	1	
10	160	1	
12	160	1	



DRILLING /  
FIXING

CONCRETE  
DRILLING /  
DEMOLITION

MIXING /  
STIRRING

CUTTING  
(CONCRETE /  
METAL)

GRINDING

SANDING /  
POLISHING

SAWING

MULTI-TOOL

ROUTERS /  
PLANERS

NAILERS /  
STAPLERS

HEAT GUN /  
LASER

CLEANING

OPE

JOBSITE  
TOOLS

SPECIALTY  
TOOLS

HAND TOOLS /  
COMBINATION SET

TOOL HOLDERS  
AND POUCHES /  
MAKPAC SYSTEM

## SDS-MAX ZENTRO DRILL BITS

### PREMIUM RANGE

Ø 12 to 15 mm : 2 cutter

Ø 16 - 50mm: 4 Cutter new carbides for better performance in reinforce concrete

Ø 32mm to 50mm: 4 Cutter and additionally reinforced carbide tip



Adapted for  
SDS-MAX Hammers

### Power

Specially developed robust head geometry ensures that even toughest applications can be mastered.

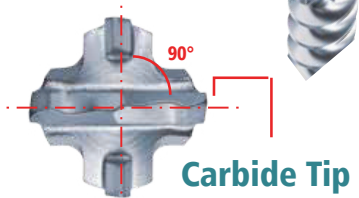

### Carbide Tip

The optimal 4x90° carbide cutting edge symmetry prevents seizing up on hitting reinforcing steel.

### Fast Drilling

Large, robust secondary cutters with dynamically curved cutting tips actively support the main carbide tip during fast drilling.



### Flute

The drilling debris is transported fast in the large-volume flute geometry.

### Accuracy

Centering point with 130° point angle ensures highly accurate, precise drilling and guarantees optimal drill guidance.

The individual wear marking is an indicator for evaluating the dimensional stability of the anchor holes.



### Impact Energy

The reinforced-core flute achieves the optimum between volume and break resistance. Vibrations are dampened and resulting in more impact energy on the carbide tip.



BIT DIA (MM)	OVERALL LENGTH (MM)	WORKING LENGTH (MM)	PER PKG	PART NO	NEW PART NO
12	340	200	1	P-17033	—
12	540	400	1	P-17049	—
12	690	550	1	P-17055	—
14	340	200	1	P-17077	—
14	540	400	1	P-17083	—
15	340	200	1	P-17108	—
15	540	400	1	P-17114	—
16	340	200	1	—	P-77730
16	540	400	1	—	P-77746
18	340	200	1	—	P-77774
18	540	400	1	—	P-77780
20	320	200	1	—	P-77811
20	520	400	1	—	P-77827
20	920	800	1	—	P-77833
22	320	200	1	—	P-77855
22	520	400	1	—	P-77861
22	920	800	1	—	P-77877
24	320	200	1	—	P-77899
24	520	400	1	—	P-77908
25	320	200	1	—	P-77914
25	520	400	1	—	P-77920
25	920	800	1	—	P-77936
28	370	250	1	—	P-77964
28	570	450	1	—	P-77970
28	670	550	1	P-17310	P-77986
30	370	250	1	P-17326	P-78019
30	570	450	1	—	P-78025
32	370	250	1	P-17348	P-78031
32	570	450	1	—	P-78047
32	920	800	1	—	P-78053
35	370	250	1	—	P-78075
35	570	450	1	—	P-78081
35	670	550	1	P-17398	P-78097
38	370	250	1	P-17407	P-78134
38	570	450	1	P-17413	P-78140
40	370	250	1	P-17429	P-78156
40	570	450	1	—	P-78162
40	920	800	1	—	P-78178
40	1320	1200	1	—	P-78184
45	570	450	1	—	P-78190
50	570	450	1	—	P-78215

# SDS-MAX rotary hammer drill bits

## STANDARD RANGE



Adapted for  
SDS-MAX Hammers

- 2 cutter T.C.T Drill bits
- Solid carbide centering tip
- Optimized flutes for fast drilling
- Long Life

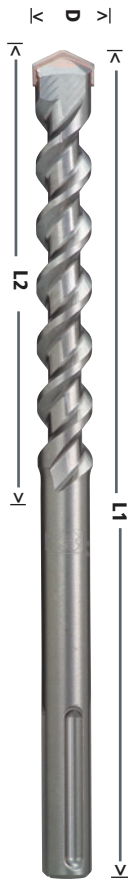

BIT DIA (D) (MM)	OVERALL LENGTH (L1) (MM)	WORKING LENGTH (L2)(MM)	PER PKG	PART NO	NEW PART NO
12	340	200	1	D-34506	D-33875
12	540	400	1	D-34512	D-33881
14	340	200	1	D-34528	D-33897
14	540	400	1	D-34534	D-33906
15	340	200	1	D-34540	D-33912
15	540	400	1	D-34556	D-33928
16	340	200	1	-	D-33934
16	540	400	1	D-34578	D-33940
18	340	200	1	D-34584	D-33956
18	540	400	1	-	D-33962
20	340	200	1	-	D-33978
20	540	400	1	-	D-33984
22	340	200	1	-	D-33990
22	540	400	1	D-34637	D-34001
24	340	200	1	-	D-34017
24	540	400	1	D-34659	D-34023
25	340	200	1	D-34665	D-34039
25	540	400	1	D-34671	D-34045
28	370	250	1	-	D-34051
28	570	450	1	-	D-34067
30	370	250	1	D-34702	D-34073
30	570	450	1	D-34718	D-34089
32	370	250	1	D-34724	D-34095
32	570	450	1	D-34730	D-34104
35	370	250	1	D-34746	D-34110
35	570	450	1	D-34752	D-34126
38	370	250	1	D-34768	D-34132
38	570	450	1	D-34774	D-34148
40	370	250	1	D-34780	D-34154
40	570	450	1	D-34796	D-34160

- DRILLING / FIXING
- CONCRETE DRILLING / DEMOLITION
- MIXING / STIRRING
- CUTTING (CONCRETE / METAL)
- GRINDING
- SANDING / POLISHING
- SAWING
- MULTI-TOOL
- ROUTERS / PLANERS
- NAILERS / STAPLERS
- HEAT GUN / LASER
- CLEANING
- OPE
- JOBSITE TOOLS
- SPECIALTY TOOLS
- HAND TOOLS / COMBINATION SET
- TOOL HOLDERS AND POUCHES / MAKPAC SYSTEM

DRILLING / FIXING

CONCRETE DRILLING / DEMOLITION

MIXING / STIRRING

CUTTING (CONCRETE / METAL)

GRINDING

SANDING / POLISHING

SAWING

MULTI-TOOL

ROUTERS / PLANERS

NAILERS / STAPLERS

HEAT GUN / LASER

CLEANING

OPE

JOBSITE TOOLS

SPECIALTY TOOLS

HAND TOOLS / COMBINATION SET

TOOL HOLDERS AND POUCHES / MAKPAC SYSTEM

## Hexagonal shank

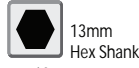

### Premium range

Tungsten carbide-tipped bit



For Model	Bit Dia (D) (mm)	Overall Length (L1) (mm)	Working Length (L2) (mm)	Per Pkg	Part No
HR3850, HR4030C, HR3520, HR3530, HR3540C, HR4030C	16	550	-	1	P-02799
	18	280	-	1	P-02808
	18	550	-	1	P-02814
	18	550	-	1	P-02814
	19	280	-	1	P-02820
	20	550	-	1	P-02858
	22	550	-	1	P-02870
	28	550	-	1	P-02939
	30	550	-	1	P-02967
	32	550	-	1	P-02989

### Standard range

Tungsten carbide-tipped bit

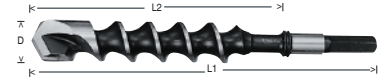

For Model	Bit Dia (D) (mm)	Overall Length (L1) (mm)	Working Length (L2) (mm)	Per Pkg	Part No
HR3520, HR3530, HR3540C, HR3850, HR4030C	16	280	155	1	D-20127
	19	280	155	1	D-20161
	19	505	365	1	D-20177
	20	280	155	1	D-20183
	22	280	155	1	D-20208
	22	505	365	1	D-20214
	25.5	280	155	1	D-20220
	28	280	155	1	D-20242
	32	280	140	1	D-20264
	32	505	360	1	D-20270
	35	280	140	1	D-20286

## SDS-MAX Mining bits

Adapted for SDS-MAX Hammers

- Can drill into rocks and natural stones which are extremely hard.
- Suitable for drilling holes for dynamite bar and tunnels in mining fields.
- Longer life & high speed compare



+37% carbide



High volume flute entries: Drilling debris leads to less friction in hole

Optimized for regrinding

BIT DIA (D) (MM)	OVERALL LENGTH (L1) (MM)	WORKING LENGTH (L2)(MM)	PER PKG	PART NO
28	670	550	1	B-39431
30	720	600	1	B-39447
32	570	450	1	B-39453
32	920	800	1	B-39469

## Recommended procedure to prevent breakage - Mining bits

To prevent from bit breakage, we recommended to perform the drilling in 3 stages as below

**Stage 1:** Drilling with a drill bit of 370mm long at initial stage



**Stage 2:** Drilling with a drill bit of 570mm long in between initial and final stage



**Stage 3:** Drilling with a drill bit of 920mm long at final stage



These stages will help to avoid bending of the drill bit when the longer one is used and will be convenient to use as well. Use of either a blower or vacuum cleaners is recommended to remove the debris while drilling.

Our normal P-series SDS Max drill bits can be used for smaller lengths.









# Chisels

## The right chisel for every chiseling job

**Advantages:**

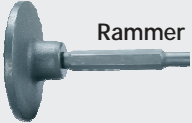
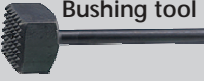
- Use of high-grade tempered steel
- Special processing and hardening process for optimal tool-life
- Minimized wear and tear
- Increased surface hardness and endurance range

Application	FOR SDS-PLUS HAMMERS	FOR SDS-MAX HAMMERS	17MM HEX	19MM HEX	21MM HEX	28.6MM HEX	30MM HEX	MAKITA SMALL
 <p><b>Bull point</b> Demolition and adjustment work in masonry and concrete. Chipping and breaking in masonry and concrete. Starts holes in concrete.</p>	●	●	●	●	●	●	●	●
 <p><b>Cold chisel</b> Adjustment work in masonry and concrete. Chipping, breaking, edging and channeling in masonry and concrete.</p>	●	●	●	●	●	●	●	
 <p><b>Grooving chisel</b> Cutting channels in concrete.</p>	●		●		●			
 <p><b>Scaling chisel</b> Removing concrete residues.</p>	●	●	●	●	●	●	●	●
 <p><b>Clay spade</b> Digging in clay, hard gravel, hard packed gravel, soil and dirt.</p>	●	●	●	●	●	●	●	
 <p><b>Rammer</b> Tamping asphalt and compacting gravel, soil and dirt.</p>		●	●	●	●	●		
 <p><b>Bushing tool</b> Roughing concrete and asphalt up.</p>	●	●	●		●			
 <p><b>Scraper</b> Scraping floor tiles, linoleum floor and clean-up.</p>	●							●

DRILLING / FIXING
CONCRETE DRILLING / DEMOLITION
MIXING / STIRRING
CUTTING (CONCRETE / METAL)
GRINDING
SANDING / POLISHING
SAWING
MULTI-TOOL
ROUTERS / PLANERS
NAILERS / STAPLERS
HEAT GUN / LASER
CLEANING
OPE
JOB SITE TOOLS
SPECIALTY TOOLS
HAND TOOLS / COMBINATION SET
TOOL HOLDERS AND POUCHES / MAKPAC SYSTEM

DRILLING /  
FIXING

CONCRETE  
DRILLING /  
DEMOLITION

MIXING /  
STIRRING

CUTTING  
(CONCRETE /  
METAL)

GRINDING

SANDING /  
POLISHING

SAWING

MULTI-TOOL

ROUTERS /  
PLANERS

NAILERS /  
STAPLERS

HEAT GUN /  
LASER

CLEANING

OPE

JOBSITE  
TOOLS

SPECIALTY  
TOOLS

HAND TOOLS /  
COMBINATION SET

TOOL HOLDERS  
AND POUCHES /  
MAKPAC SYSTEM

# Premium chisels

- No need to re-sharpen It is possible to demolish concrete for a longer time
- Suitable for indoor decorators, constructors and masonry worker who use SDS-PLUS and SDS-MAX hammers







Special shape of the tip gives superior performance

## Long Life







New technology ensures our steels remain sharp and efficient through out their life time. With a higher material removal rate and no repeated re-sharpening these new sheets reduces downtime and are significantly more cost effective



Shank type	Chisels	length (mm)	Width (mm)	Part no
 <b>FOR SDS-PLUS HAMMERS</b>	Premium Bull point 	250	-	B-64238
	Premium Cold chisel 	250	20	B-64244
	Premium Scaling chisel 	250	40	B-64250
 <b>FOR SDS-MAX HAMMERS</b>	Premium Bull point 	400	-	B-64266
	Premium Cold chisel 	400	25	B-64272
	Premium Scaling chisel 	380	50	B-64288
<b>28.6MM HEX</b>	Premium Bull point 	400	-	B-10372
<b>30MM HEX</b>	Premium Bull point 	400	-	B-10388







## Bull Point

- For demolishing concrete

Suitable For	Length (mm)	D series New Part No.	D series	Part No.
 Adapted for all SDS-MAX hammers	280			A-80787
	300	D-34176		
	400	D-34182		A-80793
	600	D-34198		P-16259
	600			A-87476
 Adapted for all SDS-PLUS hammers	250	D-08713		
	400	D-19015		
 HR3520B, HR3850B, HR5000	300	D-20074	D-29234	
	450	D-19196	D-29240	
 17 mm HR3520, HR3850, HR4030C, HM0810, HM0810T, HM1130	210	D-16374		
	280	D-08682		
	450	D-16863		A-80547
 21 mm HM1201	320	D-16499		A-82747
	450	D-23824		A-80553
	600	D-30994		
 30 mm HM1302, HM1303, HM1304, HM1305, HM1306, HM1307C, HM1317C	410	D-15285		
 28.6 mm HM1800, HM1801, HM1810, HM1812, HM1802	410	D-17631		
Makita small shank HK1800, HK1810	220			B-06921

## Cold Chisel

- For chipping, edging, channeling and breaking concrete chunks

Suitable For	Length (mm)	D series New Part No.	D series New Part No	Part No.
 Adapted for all SDS-MAX hammers	24 x 600			P-16287
	25 x 280			A-80802
	25 x 300	■ D-34207	D-34453	
	25 x 400	■ D-34213		
	25 x 600	■ D-34229	D-34475	
 Adapted for all SDS-PLUS hammers	20 x 250	■ D-08729		
	20 x 400	D-19021		
 HR3520B, HR3850B, HR5000	26 x 300		D-29250	
	26 x 450	■ D-19205	D-29262	
 17 mm HR3520, HR3850, HR4030C, HM0810, HM0810T, HM1130	19 x 280	■ D-08707		
	19 x 450	■ D-16879		A-80575
 21 mm HM1201	26 x 450	■ D-17594		A-80581
 30 mm HM1302, HM1303, HM1304, HM1305, HM1306, HM1307C, HM1317C	30 x 400	■ D-15300		
 28.6 mm HM1800, HM1801, HM1810, HM1812, HM1802	28 x 410	D-17647		798383-7

DRILLING / FIXING

CONCRETE DRILLING / DEMOLITION

MIXING / STIRRING

CUTTING (CONCRETE / METAL)

GRINDING

SANDING / POLISHING

SAWING

MULTI-TOOL

ROUTERS / PLANERS

NAILERS / STAPLERS

HEAT GUN / LASER

CLEANING

OPE

JOB SITE TOOLS

SPECIALTY TOOLS

HAND TOOLS / COMBINATION SET

TOOL HOLDERS AND POUCHES / MAKPAC SYSTEM







DRILLING /  
FIXING

## Scaling Chisel

- Wide chisels for chipping away scale of concrete spatter



CONCRETE  
DRILLING /  
DEMOLITION

Suitable For	Length (mm)	D series New Part No.	D series Part No	Part No.
 Adapted for all SDS-MAX hammers	50 x 300			A-80830
	50 x 400	D-34235	D-34481	
	80 x 300	D-34241		
 Adapted for all SDS-PLUS hammers	40 x 250	D-08735		
	40 x 250			A-87052
	50 x 215	D-25616		
	80 x 250		D-61020	
	80 x 150		D-61042	
 HR3520B, HR3850B, HR5000	50 x 300	D-20096		
	 17 mm HR3520, HR3850, HR4030C, HM0810, HM0810T, HM1130	50 x 280	D-20694	
 21 mm HM1201	70 x 320	D-20672		
	 30 mm HM1302, HM1303, HM1304, HM1305, HM1306, HM1307C, HM1317C	75 x 310	D-23868	
 28.6 mm HM1800, HM1801, HM1810, HM1812, HM1802	75 x 520	D-20725		
	MAKITA SMALL SHANK HK1800, HK1810	50 x 150		B-07347
	50 x 220			B-07010

MIXING /  
STIRRING

CUTTING  
(CONCRETE /  
METAL)

GRINDING

SANDING /  
POLISHING

SAWING

MULTI-TOOL

ROUTERS /  
PLANERS

NAILERS /  
STAPLERS



HEAT GUN /  
LASER

## Grooving chisels

- For grooving, channeling or removal of heavy scale



CLEANING

Suitable For	Length (mm)	Part No.
 Adapted for all SDS-PLUS hammers	8 x 170	A-30075
	12 x 170	A-86371
 17 mm HR3520, HR3850, HR4030C, HM0810, HM0810T, HM1130	26 x 280	A-48561

OPE

JOBSITE  
TOOLS

## Clay Spade

- For digging in clay, scale etc.



SPECIALTY  
TOOLS

Suitable For	Length (mm)	Part No.
 Adapted for all SDS-PLUS hammers	105 x 400	A-17653
 30 mm HM1302, HM1303, HM1304, HM1305, HM1306, HM1307C, HM1317C	120 x 500	B-10300
 28.6 mm HM1800, HM1801, HM1810, HM1812, HM1802	140 x 546	798384-5

HAND TOOLS /  
COMBINATION SET

TOOL HOLDERS  
AND POUCHES /  
MAKPAC SYSTEM

## Rammer

- For tamping operations





Suitable For	Length (mm)	Part No.
 Adapted for all SDS-MAX hammers	140	A-19875
 30 mm HM1302, HM1303, HM1304, HM1305, HM1306, HM1307C, HM1317C	200	A-31485
 28.6 mm HM1800, HM1801, HM1810, HM1812, HM1802	200	798385-3

## Bushing Tool

- For concrete surface removal
- Type A: Use with shank (A-19897)



Suitable For	Length (mm)	Type	Part No.
 Adapted for all SDS-MAX hammers	67 x 67	A	A-19881
 17 mm HR3520, HR3850, HR4030C, HM0810, HM0810T, HM1130	60 x 60	-	A-21484
 21 mm HM1201	60 x 60	-	A-21490

## Scraper Assembly

- For removing linoleum tile and other flooring

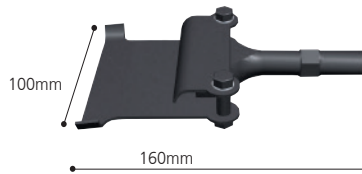

Suitable For	Length (mm)	Part No.
 Adapted for all SDS-PLUS hammers	100	A-30106

## SDS-PLUS Chisel Assortment (3pcs/set)

With aluminum case.

-  Adapted for all SDS-PLUS hammers



Suitable For	Length (mm)	Part No.
Bull point	250	D-05181
Cold chisel	20 x 250	
Scaling chisel	40 x 250	

- DRILLING / FIXING
- CONCRETE DRILLING / DEMOLITION
- MIXING / STIRRING
- CUTTING (CONCRETE / METAL)
- GRINDING
- SANDING / POLISHING
- SAWING
- MULTI-TOOL
- ROUTERS / PLANERS
- NAILERS / STAPLERS
- HEAT GUN / LASER
- CLEANING
- OPE
- JOBSITE TOOLS
- SPECIALTY TOOLS
- HAND TOOLS / COMBINATION SET
- TOOL HOLDERS AND POUCHES / MAKPAC SYSTEM

# Core Bit

For use in Concrete, Masonry and Natural stone  
Makita offers a comprehensive range of tools and accessories for heavy rotary hammer drills.

DRILLING /  
FIXING

CONCRETE  
DRILLING /  
DEMOLITION

MIXING /  
STIRRING

CUTTING  
(CONCRETE /  
METAL)

GRINDING

SANDING /  
POLISHING

SAWING

MULTI-TOOL

ROUTERS /  
PLANERS

NAILERS /  
STAPLERS

HEAT GUN /  
LASER

CLEANING

OPE

JOBSITE  
TOOLS

SPECIALTY  
TOOLS

HAND TOOLS /  
COMBINATION SET

TOOL HOLDERS  
AND POUCHES /  
MAKPAC SYSTEM

## Ratio Quick Core Bit

Ratio Quick core bit, together with pilot bits, flute bodies, shank extensions and adapters make up the Ratio System a tool system which allows the individual components to be used in various combinations.

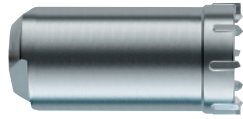

Core Bit Ø (mm)	Core bit Length	Max drilling Depth (mm)	Part No.
65	105	150	P-16835(H)

### Ratio SDS-MAX Adapter (Versio System)



SDS-MAX	Length (mm)	Part No.
	195	P-03888(H)

Please Note: Ratio Core Bits and accessories are not interchangeable with any other core bit system

## TCT Hollow Core Bit System

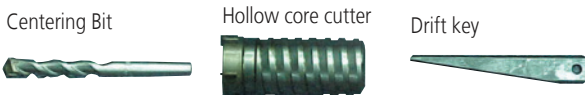

For Core Bit Dia. (mm)	Max. drilling depth (mm)	Hollow core Cutter Part No.	Centering Bit 1:20 Part No.	Drift Key Part No.
65	100	P-03791	P-03838 11 x 120	P-03763 140mm

For Model: HR4000C, HR4001C, HR4002, HR4011C, HR4500C, HR4501C, HR4511C, HR5001C, HR5201C

For Core Bit Dia. (mm)	Max. drilling depth (mm)	Hollow core Cutter Part No.	Centering Bit 1:20 Part No.	Drift Key Part No.
65	100	P-03791	P-03838 11 x 120	P-03763 140mm

### Hollow Core Bit Adapter

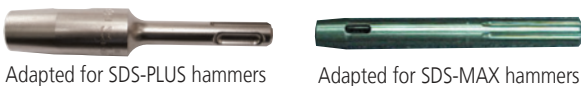

Adapted for SDS-PLUS hammers

Adapted for SDS-MAX hammers

Overall Length (mm)	Part No.
180	P-16994
450	P-17005

Adapted for SDS-MAX hammers

For Core bit dia (mm)	Part No.
65	P-03729

For Model: HR3520, HR3530, HR3850, HR4030

For Core bit dia (mm)	Part No.
65	P-03729

Please Note: TCT Hollow Core Bits and accessories are not interchangeable with any other core bit system

## TCT Core Bit

Please Note: TCT Core Bits and accessories are not interchangeable with any other core bit system



Outer dia (mm)	Depth (mm)	Max. drilling depth (mm)	Part No.
*66	108	180	A-86620
*79	108	180	A-86636

For Model: HR2440, HR2450, HR2460, HR2470/T, HR2810, HR3000C, HR3200C, HR3210C

\* These sizes are not advisable for HR2440 / HR2450

Outer dia (mm)	Depth (mm)	Max. drilling depth (mm)	Part No.
*66	108	180	A-86620
*79	108	180	A-86636

For Model: HR3520, HR3850, HR4000C, HR4002, HR4030C, HR4500C, HR4501C, HR4511C, HR5000C, HR5001C, HR5201C

### Core Bit Adapter

(with center bit, O ring & rod)



Shank	For Core bit dia (mm)	Max. drilling depth (mm)	Part No.
Hex	25-40	200	798006-7
Star	25-40	200	A-19358

For Model: HR3520, HR3850, HR4030C

Shank	For Core bit dia (mm)	Max. drilling depth (mm)	Part No.
Hex	25-40	200	798006-7

For Model: HR4000C, HR4002, HR4500C, HR4501C, HR4511C, HR5000, HR5001C

Shank	For Core bit dia (mm)	Max. drilling depth (mm)	Part No.
Star	25-40	200	A-19358

### Rod

[used to remove core bits]



For Model: HR2440 / F, HR2450 / F, HR2460, HR2470, HR2800, HR2810, HR3000C, HR3520, HR3520B, HR3200C, HR3210C, HR3850/B, HR4000C, HR4002, HR4501C, HR5000, HR5201C

For Core bit dia (mm)	Part No.
25-40	256806-6

### Center Bit

[for centering core bit.]



For Core bit dia (mm)	Part No.
35-79	752031-2

For Model: HR2440/F, HR2450/F, HR2460, HR2470, HR2800, HR2810, HR3000C, HR3210C

For Core bit dia (mm)	Part No.
35-79	752031-2

For Model: HR3520, HR3520B, HR3850, HR3850B, HR4000C, HR4002, HR4501C, HR5000, HR5001C, HR5201C



For Core bit dia (mm)	Part No.
25-40	752045-1

For Core bit dia (mm)	Part No.
40-118	752027-3

## Drill Chuck Adapter Assembly (For the slide chuck)

	For Models	Part No.	Part No (With country of origin)
With screw M6 x 22 	HR2440/F, HR2450/F, HR2010, HR2400/10, HR2430, HR2800/10, HR3000C, HR3200C/10C	-	D-14087 / D-14093
For the swivel chuck (with screw M6 x 22) 	HR2010, HR2400, HR2410	122331-8	-
With screw M6 x 22 	HR2510	321637-360	-

## Dual Slot Adapter

	Shank	Part No.
SDS-PLUS  SDS-MAX Shank	For use of SDS-PLUS drill bits with SDS-MAX hammers Adapter SDS-MAX to SDS-PLUS	P-17027
SDS-PLUS  13mm Hex Shank	For use of SDS-PLUS drill bits with 13mm Hex shank hammers Adapter 13mm Hex shank to SDS-PLUS	P-04195

## Ground Rod Adapter (For driving electrical grounding tools)

	Shank	Part No.
	 Spline Shank HR3520B, HR3850B	798132-2

## Quick Change Drill Chuck

	For Models	Part No.
Quick change drill chuck set 	HR2450T/FT, HR2470T / HR2610T / HR2611FT / HR2630T / HR2630FT / DHR242, HR2810T / HR2811FT	194079-2
	DHR281, DHR283, HR002G	199139-5
	HR3012FCT	191F46-4
Tool Holder Set 	HR2450T/FT, HR2470T / HR2610T / HR2611FT / HR2630T / HR2630FT / DHR242, HR2810T / HR2811FT	194080-7
	DHR281, DHR283, HR002G	199138-7
	HR3012FCT	191F47-2

## Drill Chuck Assembly

For SDS-Plus Hammers

For Models	Part No.
DHR171, DHR182, <b>DHR183</b> , DHR202, DHR242, DHR243, DHR263, DHR264, DHR280, DHR281, DHR282, DHR283, HR002G, HR003G, HR007G, HR166D, HR2230, HR2300, HR2320T, HR2460, HR2460F, HR2470, HR2470F, HR2470FT, HR2470T, HR2475, HR2600, HR2601, HR2630, HR2630T, HR2631F, HR2631FT, HR2641, HR2652, HR2653, HR2653T, HR2663, HR2800, HR2810, HR2810T, HR2811F, HR2811FT, HR3001C, HR3011FC, HR3012FC	122574-2
HR001G, HR002G, HR003G, HR007G, <b>HR010G</b> , HR2230, HR2460, HR2470, HR2470F, HR2475, HR2630, HR2631F, HR2652, HR2810, HR3001C, HR3011FC, HR3012FC	194041-7

## Dust bag Assembly

For Model	Type	Part No.
HR2430 	Standard	122614-6
HR2432	Standard	122708-7

## Blow Out Bulb

To be used after drilling to clean out the hole



Part No.
765009-6

## Dust Cap / Sealing Cap

Bit diameter (mm)	Part No.
6 - 14.5	421342-3
12 - 16	421664-1
DX06, DX07, DX08, DX09, DX10, DX11, DX12, DX14	424474-5
DX16	 422992-7

- DRILLING / FIXING
- CONCRETE DRILLING / DEMOLITION
- MIXING / STIRRING
- CUTTING (CONCRETE / METAL)
- GRINDING
- SANDING / POLISHING
- SAWING
- MULTI-TOOL
- ROUTERS / PLANERS
- NAILERS / STAPLERS
- HEAT GUN / LASER
- CLEANING
- OPE
- JOB SITE TOOLS
- SPECIALTY TOOLS
- HAND TOOLS / COMBINATION SET
- TOOL HOLDERS AND POUCHES / MAKPAC SYSTEM

## Dust Extraction System set



For SDS-Plus Hammers

For Models	Type	Part No.
DHR242	DX01	195897-1
DHR280	DX08	199579-7
DHR281, DHR283	DX09	199583-6
HR008G, HR3011FC	DX10	191F95-1
HR3012FC	DX11	191G00-4
HR003G	DX12	191E52-3
HR002G	DX14	191E58-1
HR007G, HR2663	DX15	122B81-7
HR010G, DHR183	DX16	1911P2-6

## Dust case set & Filter



Dust case set

Filter

**HEPA**  
filter

For Model	Type	Part No.
HR2661	Dust case + Filter	198982-9
HR2661	Filter	196164-7
DX05 (DHR182)	Dust case + Filter	199595-9
DX05, DX16 (DHR182)	Filter	199596-7
DX08, DX09, DX12, DX14	Dust case + Filter	199555-1
DX10, DX11	Dust case + Filter	191F49-8
DX15	Dust case + Filter	199586-0
DX01, DX08, DX09, DX10, DX11, DX12, DX14, DX15	Filter	199557-7
DX16	Dust case + Filter	1911P5-0

## Dust Cup Attachment

Suited for interior or overhead drilling where dust exposure must be controlled.



For some models grip base set/spacer is required to attach the dust cup set

For Model	Grip base set Part no	Dust cup Set Part no
HR1841F, DHR182, DHR171, HR166D	194581-5	198362-9
DHR202, DHR263	194582-3	
HR2800, HR2810	-	-
HR002G, DHR281, DHR283, HR2610T, HR2611FT, HR2630T, HR2631FT, HR3012FC	-	195179-1
HR003G, HR007G, DHR242, DHR280, HR2600, HR2630, HR2631F, HR2661, HR2663	-	195173-3
HR008G, HR3011FC, HR3001C	191L91-5 (spacer)	-
HR010G, DHR183	-	1911P8-4

## Grip



For Model	Side Handle Assembly	Grip assembly	Grip 36 Complete
DHR280, 282, HR002G, HR003G, HR3011FC	-	126882-3	-
HR2010	-	-	153503-4
HR2020 / HR2432	-	135302-6	153503-4
HR2600, 10/10T, 11F/FT, HR2630/T, HR2631F/1FT	-	122878-2	154935-8
BHR200SJ	-	-	152624-9
DHR202 / HR1830 / HR2475 / HR2800 / HR2810 / DHR182	-	-	158057-6
HR3000C	-	134889-5	152554-4
HR4000C	-	134803-1	158131-0
HR3530 / HR4002 / HR4030C / HM0870C / HM0871C / HM0860C	-	-	-
HR3200C, HR3210C	-	135197-7	-
HR3530	-	321248-4	-
HR3540C / HR3541FC / HR4001C / HR4011C / HR4501C / HR4511C	134890-0	135209-6	158131-0
HR4500C	134915-0	134916-8	-
HR5201C / HR5211C	135269-8	-	-
HR5202C, HR5212C	-	135629-4	-
HR5001C	134945-1	-	-
HR3520 / HR3850	-	-	273472-4
HR5000	134887-9	-	273472-4
HM0810T	-	-	273457-0
HM1101C / HM1111C	134890-0	-	-
HM1201	-	-	273467-7
HM1203C / HM1213C	135269-8	-	-
HM1214C / HR5202C / HR5212C	135283-4	-	-

## Hook

For model	Part No.
HR007G	191W90-3
DHR183	1911K0-5

## Hammer Trolley

- Supports the weight in transit
- Features: Trolley for 30kg Hammer



For model	Part No.
For HM1802, HM1812, HM1801 / HM1810T	D-54972



## Hammer Service Kits

Essential for effective maintenance of the hammers  
 Consists of Carbon brush, O-rings and grease  
 Required whenever carbon brushes are replaced



### For Breakers & Demolition Hammers

For Model	Part No.
HM001G	191N57-7
HM002G	191N77-1
DHK180	191C39-3
HK0500	193397-5
HK1810	193394-1
HK1820	195194-5
HM0810T	193242-4
HM0860C	195204-8
HM0871C, HM0870C	195113-1
HM1101C, HM1111C	195260-8
HM1130	193405-2
HM1201	193244-0
HM1202C, HM1202	193391-7
HM1203C, HM1213C, HM1214C	195114-9
HM1303	193393-3
HM1304	195201-4
HM1305	183952-1
	195203-0
HM1306	195212-9
HM1307C, HM1317C	195103-4
HM1511	191M24-6
HM1801 / HM1810	195205-6
HM1812, HM1802	197127-6

### Oil Supply and Grease Vessel

For all oil lubricating machines 

Contents	Type	Part No.
Oil 100 ml	—	181118-7

For all grease lubricating machines 

Grease 30 g	R No. 00	181490-7
-------------	----------	----------

For use on the shank of the bit 

Contents	Type	Part No.
Grease 100 ml	—	194683-7

For 18 - 24mm Hammers 

Grease 100 g	FA No. 2	188088-1
--------------	----------	----------

## For Rotary Hammers

A: Use with Slide-Chuck System

B: Use with Swivel-Chuck System

For Model	Type	Part No.
HR002G, DHR242, DHR281, DHR283		195833-7
HR003G, HR007G, DHR280		199233-3
HR005G		196966-1
HR006G		191N79-7
HR008G		1910R8-2
DHR171		198564-7
DHR182, HR010G		199544-6
DHR202		195193-7
DHR263		195189-8
DHR400		197298-9
HR1830 (LOW VOLTAGE)		188388-9
HR1830		195198-7
HR2010	A	193395-9
HR2010	B	193396-7
HR2020, HR2432, HR2440, HR2450/F/T		195196-1
HR2400 (Red Chuck)	A	193386-0
HR2400 (Black Chuck)	B	193387-8
HR2410, HR2420	B	193389-4
HR2410, HR2420, HR2430, HR2431	A	193388-6
HR2460, HR2470, HR2470T		195263-2
HR2475		195109-2
HR2510		193404-4
HR2600, HR2610		195105-0
HR2611F		195107-6
HR2630		196968-7
HR2631FT, HR2611FT		195108-4
HR2631F		196967-9
HR2630T, HR2610T		195106-8
HR2663		196965-3
HR2800, HR2810		195206-4
HR3000C		193390-9
HR3011FC		191F03-2
HR3012FC		191F05-8
HR3200C, HR3210C		195199-5
HR3520		193280-6
HR3530		195211-1
HR3540, HR3541FC		195192-9
HR3850, HR3850B		193281-4
HR4000C		193283-0
HR4001C, HR4011C, HR4002		195195-3
HR4030C		195207-2
HR4003C, HR4013C		196532-4
HR4500C		193407-8
HR4501C, HR4511C		195210-3
HR5000		193284-8
HR5001C		193392-5
HR5201C, HR5211C		195191-1
HR5212C, HR5202C		196865-7

DRILLING / FIXING

CONCRETE DRILLING / DEMOLITION

MIXING / STIRRING

CUTTING (CONCRETE / METAL)

GRINDING

SANDING / POLISHING

SAWING

MULTI-TOOL

ROUTERS / PLANERS

NAILERS / STAPLERS

HEAT GUN / LASER

CLEANING

OPE

JOBSITE TOOLS

SPECIALTY TOOLS

HAND TOOLS / COMBINATION SET

TOOL HOLDERS AND POUCHES / MAKPAC SYSTEM

# MIXING / STIRRING

Mixer, Vibrator



**UT001G 240mm** 40V MAX | **XGT**

**Concrete Mixer**



**Combination of XGT system and BL motor provides output power similar or superior to corded models in the same class**

- 2-speed mechanical gearbox capable of
  - 0-500rpm in low speed for mixing high viscous material such as concrete
  - 0-920rpm in high speed for fast mixing materials such as mortar or paint
- Variable speed dial and trigger for to adjust the blade speed in fine increments to better suit the materials
- D shaped handle with soft rubber grip allowing the user to operate the tool ergonomically with less fatigue
- Soft start slows the blade speed at the start of mixing providing less reaction force to the user and minimizing the spatter of material

**40Vmax MOTOR BL XPT**

<b>Blade diameter</b>	240 mm (9-1/2")
<b>No Load Speed (RPM)</b>	High / Low: 0 - 920 / 0 - 500
<b>Shaft holder</b>	M12 / M14
<b>Sound Pressure Level</b>	81 dB(A)
<b>Sound power level</b>	92 dB(A)
<b>Vibration level (m/s<sup>2</sup>)</b>	Operation w/o load: 2.5 m/s or less
<b>Dimensions (L x W x H)</b>	414 x 458 x 235 mm
<b>Net weight</b>	4.97 kg (without battery, mixing blade and shaft)

**Standard Equipment:** M12 shaft holder with Shaft, Mixing blade 220, M14 shaft holder, Wrench 13, 19, 22.

**AVAILABLE VARIANTS**

4.0Ah	"Z" VARIANT
<b>UT001G M1</b> INCLUDES 1 BATTERY / 1 CHARGER	<b>UT001G Z</b> TOOL ONLY (DOES NOT INCLUDE BATTERY/ CHARGER)

**DUT130** 18V | **LXT**

**Cordless Mixer**



**Cordless Li-ion Mixer with Brushless Motor**

- 2-speed mechanical gearbox capable of mixing wide range of applications
- Variable speed dial and trigger for to adjust the blade speed in fine increments to better suit the materials
- Soft start slows the blade speed at the start of mixing providing less reaction force to the user and minimizing the spatter of material

**18V LXT MOTOR BL XPT**

<b>Blade Diameter</b>	165 mm (6-1/2")
<b>No Load Speed (RPM)</b>	High / Low: 0 - 1,300 / 0 - 350
<b>Shaft Holder</b>	M12 / M14
<b>Dimensions (L x W x H)</b>	w/ Mixing Blade: 920x89x231 mm w/o Mixing Blade: 323x89x231 mm
<b>Net weight</b>	2.8 kg (without battery, mixing blade and shaft)

**Standard Equipment:** M12 shaft holder with Shaft and Mixing Blade, Grip, Wrenches

**AVAILABLE VARIANTS**

5.0Ah	"Z" VARIANT
<b>DUT130 RTE</b> INCLUDES 2 BATTERIES / 1 CHARGER AND TOOL BAG	<b>DUT130 Z</b> TOOL ONLY (DOES NOT INCLUDE BATTERY / CHARGER OR CARRY CASE)

**UT2204** 

**Mixer**



**850W heavy duty and high torque mixer.**

- Rear handle with soft rubber grip, ergonomically designed for comfortable operation.
- Dust cover effectively protects the motor and the transmission parts.

**303mm**

<b>Continuous rating Input</b>	850W
<b>Mixing blade diameter</b>	220mm
<b>Shaft Holder</b>	M12
<b>No load speed</b>	550rpm
<b>Dimensions (L x W x H)</b>	929mm x 89mm x 152mm
<b>Net weight</b>	3.4kg
<b>Power supply cord</b>	2.5m

**Standard Equipment:** Wrenches, Side Grip.

**UT1305** 

**Mixer**



**The best mixer for mixing paint, tile cement, structure plaster and filler at high speed.**

- Heavy duty and high speed mixer
- Rear handle with soft rubber grip, ergonomically designed for comfortable operation
- Side handle provides maximum operator control during operation
- Dust cover effectively protects the motor and the transmission parts
- Indicator lamp (pilot lamp)

**303mm**

<b>Continuous rating input</b>	850W
<b>Blade Diameter</b>	165 mm
<b>No Load Speed (RPM)</b>	1,300
<b>Shank size of tool holder portion</b>	M12
<b>Dimensions (L x W x H)</b>	942x87x152 mm
<b>Net weight</b>	2.6 kg
<b>Power supply cord</b>	2.5 m

**Standard Equipment:** Mixing Blade, Soft shaft

- MIXING / FIXING
- CONCRETE DRILLING / DEMOLITION
- MIXING / STIRRING
- CUTTING (CONCRETE / METAL)
- GRINDING
- SANDING / POLISHING
- SAWING
- MULTI-TOOL
- ROUTERS / PLANERS
- NAILERS / STAPLERS
- HEAT GUN / LASER
- CLEANING
- OPE
- JBSITE TOOLS
- SPECIALTY TOOLS
- HAND TOOLS / COMBINATION SET
- TOOL HOLDERS AND POUCHES / MAKPAC SYSTEM

**UT1400** 140mm



**Hand-held Mixer**



**This powerful 1300W, 1-speed mixing tool highly suitable for professional use up to 40-50 kg / litres.**

- Due to its technical features this tool suits the needs of certain professionals for mixing paint, glue, plaster, etc.



<b>Continuous rating Input</b>	1,050W (127V) / 1,300 (220V)
<b>Mixing blade diameter</b>	140mm (5-1/2")
<b>No load speed</b>	0-850rpm (127V) / 0-900rpm (220V)
<b>Shank size</b>	M14
<b>Capacity</b>	50L
<b>Dimensions (L x W x H)</b>	430 x 180 x 305mm
<b>Net weight</b>	5.2kg

**VR001G**

40V MAX |

**Concrete Vibrator**



**Combination of XGT battery and brushless motor allows the machine compatible with large diameter shafts**

- Two power mode selection (normal/power) allows to use the machine for a wide range of jobsites
- Switch cover protects switch trigger and lock-on button from being blocked by adhered and hardened material such as concrete.



<b>Flexible shaft diameter</b>	ø28mm, ø32mm, ø38mm
<b>Flexible shaft length: m</b>	2.4m
<b>Vibration per minute: VPM</b>	15,500 (in power mode) / 12,000 (in normal mode)
<b>Work amount (min) (with 4.0Ah)</b>	45 (in power mode) / 60 (in normal mode)
<b>Flexible shaft thread size</b>	M6 x 1.0 (Flexible core shaft) / M36 x 1.5 (Coupling of outer casing)
<b>Vibration level</b>	4.3 m/s
<b>Dimensions (L x W x H)</b>	282 x 112 x 258
<b>Net weight</b>	1.4kg (without battery and flexible shaft)

**AVAILABLE VARIANTS**

**"Z" VARIANT**

**VR001G Z**  
TOOL ONLY  
(DOES NOT INCLUDE BATTERY / CHARGER / FLEXIBLE SHAFT / CARRYING CASE)

**VR004C** 52mm | **VR002C** 43mm

36V |

**Concrete Vibrator**



**Large diameter vibrator vibrating enables compaction over a wide area**

- High frequency motor is placed in the vibration section to rotate the vibration weight directly without rotation transmitting rod
- Inside the shaft pipe, there run only lead wires and no rotation transmitting rod, making the flexible shaft lightweight
- Powered by PDC1200/ PDC01 portable power pack (optional)
- Less user fatigue due to the battery weight transferred from the tool body to the portable power pack on user's back
- Lower vibration transmitted to user
- Run time VR004C: 200min with PDC1200 / 60min with PDC01
- Run time VR002C: 300min / with PDC1200 / 100min with PDC01

	<b>VR004C</b>	<b>VR002C</b>
<b>Diameter of vibrator</b>	52 mm	43 mm
<b>Flexible shaft assembly length</b>	3m	3mm
<b>Vibrations per minute (VPM)</b>	12,000	12,000
<b>Vibration level (m/s<sup>2</sup>)</b>	2.5	2.5
<b>Net weight</b>	13.7 kg	12.9 kg

**AVAILABLE VARIANTS**

**"Z" VARIANT**

**VR004C Z**  
TOOL ONLY  
(DOES NOT INCLUDE POWER PACK UNIT)

**"Z" VARIANT**

**VR002C Z**  
TOOL ONLY  
(DOES NOT INCLUDE POWER PACK UNIT)

**Flexible shaft for vibrators**



For model	Dia.	Length	Part No.
VR001G	32mm	2.4m	■ 1910C2-9
VR001G	38mm	2.4m	■ 1910C4-5

**Battery Case**

Battery cover minimizes the chance that spattered material might adhere to the battery



		Part No.
VR001G	BL4020, BL4040	■ 136704-9 (standard)
	BL4050F/ BL4080F	■ 1910J1-0
	PDC01/ PDC1200	■ 1910J4-4*
UT001G	BL4020, BL4040	■ 122D95-8 (standard)
	BL4050F, BL4080F	■ 1911R6-2

(\*Use with Adapter 191N62-4)

**Shoulder Strap**





For model	Part No.
VR001G	■ 161347-8

## Mixing blade for Mixer

### Mixing blade for model UT1400 / UT001G\* / DUT130\*

\*M14 shaft holder (327B35-1) is required for models UT001G and DUT130

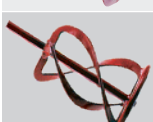
	Materials	Mixing Effect	Diameter	Mixing Quantity	Shaft	Total Length	Part No.
	Thin, light and fluid materials, such as colours, base, sludges	Top to bottom	120 mm	16 - 30 kg	M14	590 mm	P-22012
The steep set wings produce a high level of cutting power for paints and liquid materials. Prevents the formation of lumps. Especially designed for continuous masses.							
	Sticky and viscous materials, such as mortar, plasters	Bottom to top	120 mm	10 - 15 kg	M14	590 mm	P-22028
Very good movement of material from bottom to top, flat helix places less demand on user and machine.							
	Sticky and viscous materials, such as mortar, plasters	Bottom to top	135 mm	15 - 30 kg	M14	590 mm	P-22040
Very good movement of material from bottom to top, flat helix places less demand on user and machine.							
	Thin, light and fluid materials, such as colours, base, sludges	Top to bottom	120 mm	10 - 25 kg	M14	590 mm	P-22056
Uses three mixing blades to compress the material from top to bottom, no splashes, but increased machine demands, therefore it is especially suited to fluid and fibrous materials, or fine, creamy, plasters. Prevents the formation of lumps.							

DRILLING  
/ FIXINGCONCRETE  
DRILLING /  
DEMOLITIONMIXING /  
STIRRINGCUTTING  
(CONCRETE /  
METAL)

GRINDING

SANDING /  
POLISHING

SAWING

MULTI-TOOL

ROUTERS /  
PLANERSNAILERS /  
STAPLERSHEAT GUN /  
LASER

CLEANING

OPE

JOBSITE  
TOOLSSPECIALTY  
TOOLSHAND TOOLS /  
COMBINATION SETTOOL HOLDERS  
AND POUCHES /  
MAKPAC SYSTEM

### Mixing blade for model UT001G / DUT130 / UT1305 / UT2204

Shape	Dia	Material	Part #	Specs	Type	With Bolt	Twin Blade	Bolt		Shaft		For Model	
								Size	Part #	Thread	Size		Part #
	130 mm	INOX	A-43670	Low load to motor due to small diameter	A			M8 x 18	265220-5	M12	L=584mm D=12mm	321086-4	UT001G DUT130 UT1305
	135 mm	Aluminium	A-43723	The blade angle is narrow. For heavy mixing material such as concrete	B	✓		W5/16 x 16	265475-2	M12	L=584mm D=12mm	A-43773	UT001G DUT130 UT1305 UT2204
	150 mm	INOX	A-43686	The blade is upward and has the ring around it. This can decrease kickback when hitting to side or bottom of vessel	A			---	---	M12	L=584mm D=12mm	321086-4	UT001G DUT130 UT1305 UT2204
	165 mm	INOX	A-43692	Four big holes can be can make easy for moving up and down	A	✓		M8 x 18	265220-5	M12	L=584mm D=12mm	321086-4	UT001G DUT130 UT1305
	175 mm	Aluminium	A-43701	Less wearing and long life	B	✓	✓	W5/16 x 16	265475-2	M12	L=584mm D=12mm	A-43773	UT001G UT1305 UT2204
	183mm	Aluminium	A-43739	The blade angle is narrow. For heavy mixing material such as concrete	B	✓	✓	W5/16 x 16	265475-2	M12	L=584mm D=12mm	A-43773	UT001G UT1305 UT2204
	190mm	Steel	A-33065	For two blades. Less wearing and long life	B	✓	✓	W5/16 x 16	265475-2	M12	L=584mm D=12mm	A-43773	UT001G UT2204
	200mm	-	A-43745	Less wearing and long life	B	✓		Thread Type	-	M12	L=584mm D=12mm	A-43773	UT001G UT2204
	201mm	Steel	A-33071	For two blades (as twice as mixing ability). Light due to aluminium	B	✓	✓	W5/16 x 16	265475-2	M12	L=584mm D=12mm	A-43773	UT001G UT2204
	220mm	Aluminium	A-43717	Big diameter and mixing widely. light due to aluminium	B	✓		M8 x 16	265440-1	M12	L=584mm D=12mm	A-43773	UT001G UT2204

A: Mixing low viscosity materials such as paints.

B: Mixing for high viscosity materials such as mortar or Plaster/

M12 shaft holder (327B34-3)

# Cutting [Concrete, Masonry, Metal]

Cutter, Power Cutter, Metal Cutter, Portable Cut-Off, Portable Band Saw, Shears and Nibblers



**CE002G** 355mm **80V MAX | XGT**

**Cordless Power Cutter (with dust collection port)**

**NEW** **DRY**



**Dust collection port** to connect with vacuum cleaner

**Achieves a cutting depth of 127mm and a high cutting speed that overwhelm the engine models**

- Equipped with anti-vibration housing with built-in spring to absorb the vibration from cutting to integrated front and rear handles
- AWS featured machine, operate the vacuum cleaner wirelessly
- Compatible with Diamond wheel only

**Standard Equipment:** Wrench, Ring

**AVAILABLE VARIANTS**

**"Z" VARIANT**

**CE002G Z**  
TOOL ONLY  
(DOES NOT INCLUDE BATTERY / CHARGER / BLUETOOTH CHIP / CARRYING CASE)

**CE001G** 355mm **80V MAX | XGT**

**Cordless Power Cutter**

**WET / DRY**



**Water supply kit** can be connected. The hose is designed to run inside the tool housing to prevent from being caught in objects.

**Achieves a cutting depth of 127mm and a high cutting speed that overwhelm the engine models**

- Equipped with anti-vibration housing with built-in spring to absorb the vibration from cutting to integrated front and rear handles
- IPX4-compatible - High water-resistance allows to operate the machine even if it is wet with water.

**Standard Equipment:** Wrench, Ring, Coupling Sleeve

**AVAILABLE VARIANTS**

**"Z" VARIANT**

**CE001G Z**  
TOOL ONLY  
(DOES NOT INCLUDE BATTERY / CHARGER / CARRYING CASE)

**DCE090** - 230mm **18Vx2 LXT**

**Cordless Power Cutter**



**Battery cover** Protects battery from water in wet cutting

**Water supply kit** can be connected. The hose is designed to run inside the tool housing to prevent from being caught in objects.

**Compact / Light Weight / Low Nose / High Power Power Cutter**

- Max. cutting capacity 88mm depth
- AFT (Active Feedback sensing Technology) prevents kickback
- Overload indicator lamp
- Low vibration for increased operator convenience
- Ideal for cutting concrete slabs, walls, pavers, or block.

**Standard Equipment:** Hex Wrench

**AVAILABLE VARIANTS**

<b>5.0Ah</b>	<b>"Z" VARIANT</b>
<b>DCE090 PT2</b> INCLUDES 2 BATTERIES / 1 TWO PORT CHARGER	<b>DCE090 Z</b> TOOL ONLY (DOES NOT INCLUDE BATTERY / CHARGER)

**EK8100WS** 405mm (16")

**Engine Power Cutter**



**Powerful and Lightweight power cutter in this class.**

- Easy and time-saving cutting even though hardest materials.
- Multi-functional switch lever : Choke, half throttle, and stopping can be controlled by a single switch lever.
- More efficient engine cooling : Obtained by using starter cover with bigger air intake area and new flywheel.

Carburetor : Diaphragm type, Starter system : Recoil

**Standard Equipment:** Water attachment kit and Abrasive wheel

- DRILLING / FIXING
- CONCRETE DRILLING / DEMOLITION
- MIXING / STIRRING
- CUTTING (CONCRETE / METAL)
- GRINDING
- SANDING / POLISHING
- SAWING
- MULTI-TOOL
- ROUTERS / PLANERS
- NAILERS / STAPLERS
- HEAT GUN / LASER
- CLEANING
- OPE
- JBSITE TOOLS
- SPECIALTY TOOLS
- HAND TOOLS / COMBINATION SET
- TOOL HOLDERS AND POUCHES / MAKPAC SYSTEM

- DRILLING / FIXING
- CONCRETE DRILLING / DEMOLITION
- MIXING / STIRRING
- CUTTING (CONCRETE / METAL)
- GRINDING
- SANDING / POLISHING
- SAWING
- MULTI-TOOL
- ROUTERS / PLANERS
- NAILERS / STAPLERS
- HEAT GUN / LASER
- CLEANING
- OPE
- JOBSITE TOOLS
- SPECIALTY TOOLS
- HAND TOOLS / COMBINATION SET
- TOOL HOLDERS AND POUCHES / MAKPAC SYSTEM

### EK7301WS - 350mm

#### Engine Power Cutter



**Powerful and compact design power cutter**



- Easy and time-saving cutting even though hardest materials.
- Multi-functional switch lever : Choke, half throttle, and stopping can be controlled by a single switch lever.
- More efficient engine cooling : Obtained by using starter cover with bigger air intake area and new flywheel.
- Carburetor : Diaphragm type, Starter system : Recoil

<b>Wheel diameter</b>	355mm (14")		
<b>Engine</b>	73mL		
<b>Max cutting depth</b>	122mm (4-13/16")		
<b>Circumferential speed</b>	80m/s		
<b>Engine power</b>	4.2kW / 5.7PS		
<b>Fuel tank</b>	1.1L		
<b>Bore size</b>	25.4mm		
<b>Sound pressure level</b>	100dB(A)		
<b>Vibration level Front handle</b>	6.2m/s <sup>2</sup>		
<b>Vibration level Rear handle</b>	4.4m/s <sup>2</sup>		
<b>Overall length</b>	770mm (30-1/4")		
<b>Net weight</b>	10.1kg (22.2lbs)		

**Standard Equipment:** Water attachment kit and Abrasive wheel

### EK7651HX1 355mm (14")

#### Engine Power Cutter

**Environment-Friendly and Cost-Saving 4-Stroke Engine**

- Automatic decompression Reduces start up required to pull the starter handle force by about 40% compared to 2-stroke power cutter
- Oil pre-filter cover can easily be removed without using tools
- Low-vibration system
- Castors for moving convenience
- Cutting dust suppression

#### Specifications:-



<b>Wheel diameter</b>	355mm (14")		
<b>Engine</b>	75.6 ml		
<b>Max. cutting depth</b>	122mm (4-13/16")		
<b>Max. output power</b>	3.0kW / 4.1PS (at 7,500 min.-1)		
<b>Max. torque</b>	4.6 (at 5,500 min.-1)		
<b>Fuel tank</b>	25.4mm		
<b>Bore size</b>	1.1L		
<b>Dimension (L x W x H)</b>	780 x 310 x 455mm (30-3/4" x 12-1/4" x 17-7/8")		
<b>Dry weight</b>	12.9kg (28.4lbs)		

**Standard Equipment:** Engine tool set, Oil, Water supply set

- DRILLING / FIXING
- CONCRETE DRILLING / DEMOLITION
- MIXING / STIRRING
- CUTTING (CONCRETE / METAL)
- GRINDING
- SANDING / POLISHING
- SAWING
- MULTI-TOOL
- ROUTERS / PLANERS
- NAILERS / STAPLERS
- HEAT GUN / LASER
- CLEANING
- OPE
- JOBSITE TOOLS
- SPECIALTY TOOLS
- HAND TOOLS / COMBINATION SET
- TOOL HOLDERS AND POUCHES / MAKPAC SYSTEM

### EK7650HX1 305mm (12")

#### Engine Power Cutter

**Environment-Friendly and Cost-Saving 4-Stroke Engine**

- Automatic decompression Reduces start up required to pull the starter handle force by about 40% compared to 2-stroke power cutter
- Oil pre-filter cover can easily be removed without using tools
- Low-vibration system
- Castors for moving convenience
- Cutting dust suppression

#### Specifications:-

<b>Wheel diameter</b>	305mm (12")		
<b>Engine</b>	75.6 ml		
<b>Max. cutting depth</b>	97 (3-13/16")		
<b>Max. output power</b>	3.0kW / 4.1PS (at 7,500 min.-1)		
<b>Max. torque</b>	4.6 N.m (at 5,500 min.-1)		
<b>Fuel tank</b>	1.1L		
<b>Bore size</b>	20mm		
<b>Dimension (L x W x H)</b>	761 x 310 x 435mm (30" x 12-1/4" x 17-1/8")		
<b>Dry weight</b>	12.7kg (28lbs)		

**Standard Equipment:** Engine tool set, Oil, Water supply set

### 4112HS 305mm (12")

#### Angle Cutter





**305mm (12") diamond wheel provides max. cutting depth of 100mm (4").**

- Features soft start for smooth start-ups.
- Smooth and comfortable cutting.
- Super Joint System protects operator and gearing from accidental locking of the wheel.

#### Specifications:-

<b>Continuous rating Input</b>	2,400W	
<b>Capacity</b>	Max. cutting : 100mm (4")	
<b>Blade diameter</b>	305mm (12")	
<b>No load speed</b>	5,000rpm	
<b>Overall length</b>	648mm (25-1/2")	
<b>Net weight</b>	11.4kg (25.2lbs)	
<b>Power supply cord</b>	2.5m (8.2ft)	

**Standard Equipment:** Socket Wrench. (Tool does not come with diamond wheels)



**DCC501** 125 mm 18V | **LXT**

**Cordless Tile Cutter (Wet / \*Dry)**



**Cuts up to 40 mm with 125 mm wheel**

- BL motor provides high power and excellent cutting performance
- Water supply attachment with a tank capacity of 500mL
- Bevel cut up to 45 degrees enables bevel cutting of bricks
- Water supply cover set (standard) - Part No. 191M48-2
- Dry cutting possible with optional dust cover attachment (\*) Part No. 191N83-6

**18V LITHIUM-ION MOTOR XPT ADT AWS BRAKE**

Blade Diameter	125 mm (5")
Hole Diameter	20 mm
Max Cutting Capacity	0°: 40 mm 45°: 27 mm
No Load Speed (RPM)	8,800
Dimensions (L x W x H)	with water supply tank 283 x 163 x 291 mm
Net weight	2.3 kg (without battery)

**Standard Equipment:** Water Supply Tank Assembly, Hex Wrench

**AVAILABLE VARIANTS**

5.0Ah	"Z" VARIANT
<b>DCC501 RTJ</b> INCLUDES 2 BATTERIES / 1 CHARGER / MARKPCX CASE	<b>DCC501 ZJ</b> TOOL ONLY (WITH MAKPCX CASE) (DOES NOT INCLUDE BATTERY / CHARGER)

**CC301D** 85mm 12V MAX | **CXT**

**Cordless Tile Cutter (Dry)**



**Smooth and powerful cutting**

- High rotational speed of 1,500RPM
- Compact design with an overall length of 313mm
- Ergonomically designed handles
- Water supply tank with large cap
- Bevel cuts up to 45 degrees
- Nickel-plated base for rust prevention

**12V MAX LITHIUM-ION CXT 45°**

Max cutting capacity	at 0 degrees : 25.5mm (1") at 45 degrees : 16.5mm (5/8")
Blade diameter	85mm (3-3/8")
No load speed (rpm)	1,600
Tank capacity	Water : 0.5L
Dimensions (L x W x H)	313x170x125mm
Net Weight	1.8kg

**Standard Equipment:** Diamond wheel, Hex Wrench, Water supply tank assembly

**AVAILABLE VARIANTS**

2.0Ah	"Z" Version
<b>CC301D WAE</b> INCLUDES 2 BATTERIES / 1 CHARGER / CARRYING CASE	<b>CC301D Z</b> TOOL ONLY (DOES NOT INCLUDE BATTERY / CHARGER OR CARRY CASE)

**4100NH** 110mm (4-3/8") 

**Tile Cutter**



**More powerful cutting tile, also cut stone, masonry, concrete**

- Water flow can easily be adjusted.
- Can be used with wet or dry type wheels.
- Apart from stone, masonry, tile and concrete cutting, Makita also has specialized wood cutting saw blade for cutter 4100NH

 wood cutting saw blade (Optional)  
(Part no: B-39475)

**303mm**

Continuous rating Input	1,200W
Capacity	Max. cutting: 34mm (1-5/16")
Blade diameter	110mm (4-3/8")
No load speed	13,000rpm
Overall length	234mm (9-1/4")
Net weight	2.9kg (6.5lbs)
Power supply cord	2.5m (8.2ft)

**Standard Equipment:** Wrench, Socket Wrench, Water Plug & Tube  
(Tool does not come with diamond wheel)

**4107R** 180mm (7-1/8") 

**Tile Cutter**



**Quick and clean cutting.**

- Waterproof construction.

**153mm**

Continuous rating Input	1,400W
Capacity	Max. cutting: 60mm (2-3/8")
Blade diameter	180mm (7-1/8")
No load speed	5,000rpm
Overall length	370mm (14-9/16")
Net weight	6.6kg (14.5lbs)
Power supply cord	5.0m (16.4ft)

**Standard Equipment:** Diamond Wheel, Socket Wrench, Offset Wrench, Water Plug & Tube

- DRILLING / FIXING
- CONCRETE DRILLING / DEMOLITION
- MIXING / STIRRING
- CUTTING (CONCRETE / METAL)
- GRINDING
- SANDING / POLISHING
- SAWING
- MULTI-TOOL
- ROUTERS / PLANERS
- NAILERS / STAPLERS
- HEAT GUN / LASER
- CLEANING
- OPE
- JBSITE TOOLS
- SPECIALTY TOOLS
- HAND TOOLS / COMBINATION SET
- TOOL HOLDERS AND POUCHES / MAKPCX SYSTEM

DRILLING /  
FIXING

CONCRETE  
DRILLING /  
DEMOLITION

MIXING /  
STIRRING

CUTTING  
(CONCRETE /  
METAL)

GRINDING

SANDING /  
POLISHING

SAWING

MULTI-TOOL

ROUTERS /  
PLANERS

NAILERS /  
STAPLERS

HEAT GUN /  
LASER

CLEANING

OPE

JOBSITE  
TOOLS

SPECIALTY  
TOOLS

HAND TOOLS /  
COMBINATION SET

TOOL HOLDERS  
AND POUCHES /  
MAKPAC SYSTEM

### SG1251J 125mm (5")



#### Wall Chaser



#### Clean, compact and comfortable.

- Ergonomically designed handle for comfort.
- Improved trigger switch - operable with the fingers of the hand holding the top handle.
- Conveniently located front cover efficiently prevents the dust from spreading, in every cutting depth.



MAKPAC - Stackable & Interlocking Tool Case 318mm

Continuous rating Input	1,400W
Capacity	Depth : 0-30mm (0 - 1-3/16") Width : 6-30mm (1/4 - 1-3/16")
Blade diameter	125mm (5")
No load speed (rpm)	10,000
Dimensions (L x W x H)	350x151x178mm (13-3/4"x5-15/16"x7")
Net weight	4.5kg (9.8lbs)
Power supply cord	5.0m (16.4ft)

### SG150 150mm (6")



#### Wall Chaser



#### Cuts a slot up to 35mm wide and 45mm deep in concrete with powerful 1,800W motor and double diamond wheel.

- The 1800W power and its cutting ability (from 7 to 35mm of width and from 7 to 45mm of depth) are ideal for electric main wires and spouts as well as for heating systems.



Continuous rating Input	1,800W
Blade diameter	150mm (6")
Capacity	Depth: 7-45mm (9/32-1-3/4") Width: 7-35mm (9/32-1-3/8")
No load speed	7,800rpm
Overall length	410mm (16-1/8")
Net weight	5.7kg (12.6lbs)

## METAL CUTTER



**CS002G 185mm** 40V MAX | XGT

**Cordless Metal Cutter**

**NEW**



**Designed mainly for single-pass cutting of 65mm metal studs, 2-1/2" equal angle steel bars and lip channel steel bars.**

- 40Vmax XGT Li-Ion battery and BL motor, deliver high power cutting performance
- Equipped with a Lever for opening/closing Safety cover
- Easy to attach/detach Dust box simply by one-hand operation

Wheel Diameter	185 mm
Max Cutting Capacity	0°: 67 mm
No Load Speed (RPM)	3,500
Sound Pressure Level	102dB(A)
Sound Power Level	113db(A)
Vibration Level	2.5 m/s or less
Dimensions (L x W x H)	350 x 232 x 270 mm
Net weight	3.5 kg (without battery)

**Standard Equipment:** Hex Wrench, Guide Rule, Safety Goggles

AVAILABLE VARIANTS

"Z" VARIANT

**CS002G Z**  
TOOL ONLY  
(DOES NOT INCLUDE BATTERY / CHARGER / CARRYING CASE)

**4131 185mm** +AC

**Metal Cutter**



**185mm metal cutter for cutting steel up to 6mm in thickness**

- Dust-free, high-speed cutting.
- Cuts steel with minimal burrs and burns.
- One-touch dust-box removable.

Continuous rating Input	1,100W
Blade diameter	185mm (7-1/4")
Capacity	Max. cutting: 63mm (2-1/2")
No load speed	3,500rpm
Overall length	358mm (14-1/8")
Net weight	5.1kg (11.3lbs)
Power supply cord	2.5m (8.2ft)

**Standard Equipment:** Carbide-Tipped Saw Blade, Hex Wrench, Safety Goggles.

**DCS553 150mm** 18V | LXT

**Cordless Metal Cutter**



**The 150mm diameter blade enables single-pass cutting of a 2-inch inner diameter metal pipe (outer diameter: 55.8mm)**

- Built-in dust collection box for cleaner work environment
- Metal chip/dust can be thrown away by just opening the dust box cap
- Increased speed (4,200 RPM) provides more comfortable operation for light load application
- Cuts 51 mm (2") conduit in a single pass

Blade Diameter	150 mm
Max Cutting Capacity	90°: 57.5 mm
No Load Speed (RPM)	4,200
Vibration Level	Cutting Metal: 2.5 m/s <sup>2</sup> or less
Sound Pressure Level	103 dB(A)
Sound Power Level	114 dB(A)
Dimensions (L x W x H)	267x186x250 mm
Net weight	3.1 kg

**Standard Equipment:** TCT Saw Blade, Hex Wrench, Safety Goggles, Guide Rule

AVAILABLE VARIANTS

"Z" VARIANT

**DCS553 Z**  
TOOL ONLY  
(DOES NOT INCLUDE BATTERY / CHARGER OR CARRY CASE)

**DMC300 76mm** 18V | LXT

**Cordless Compact Cut Off**

**NEW**



(For accessories: Refer Page # 157)

**Compact and well balanced for increased maneuverability**

- Designed to have enough power and compactness for enabling small jobs such as cutting thin sheet metals, PVC pipes, plaster boards, Tile and etc
- Ideal for automotive repair shops, plumbing traders and air conditioning equipment suppliers

Wheel diameter	76 mm
Hole diameter	9.5, 10.0 mm
Wheel plate thickness	1.0 mm
No load speed (RPM)	20,000
Max cutting capacity	with dust cover attachment: 13.5 mm without dust cover attachment: 16.0 mm
Circumference of grip portion	156 mm
Dimensions (L x W x H)	253 x 104 x 182 mm
Net weight	1.1 kg (without battery)

**Standard Equipment:** Hex Wrench

AVAILABLE VARIANTS

<b>5.0Ah</b>	<b>"Z" VARIANT</b>
<b>DMC300 RTJ</b> INCLUDES 2 BATTERIES / 1 CHARGER / MAKPAC CASE	<b>DMC300 Z</b> TOOL ONLY (DOES NOT INCLUDE BATTERY / CHARGER / CARRYING CASE)

- MIXING / FIXING
- CONCRETE DRILLING / DEMOLITION
- MIXING / STIRRING
- CUTTING (CONCRETE / METAL)
- GRINDING
- SANDING / POLISHING
- SAWING
- MULTI-TOOL
- ROUTERS / PLANERS
- NAILERS / STAPLERS
- HEAT GUN / LASER
- CLEANING
- OPE
- JOB SITE TOOLS
- SPECIALTY TOOLS
- HAND TOOLS / COMBINATION SET
- TOOL HOLDERS AND POUCHES / MAKPAC SYSTEM

- DRILLING / FIXING
- CONCRETE DRILLING / DEMOLITION
- MIXING / STIRRING
- CUTTING (CONCRETE / METAL)
- GRINDING
- SANDING / POLISHING
- SAWING
- MULTI-TOOL
- ROUTERS / PLANERS
- NAILERS / STAPLERS
- HEAT GUN / LASER
- CLEANING
- OPE
- JOBSITE TOOLS
- SPECIALTY TOOLS
- HAND TOOLS / COMBINATION SET
- TOOL HOLDERS AND POUCHES / MAKPAC SYSTEM

PB002G
40V MAX |

Cordless Portable Band Saw

**Superior Cutting efficiency achieved by BL motor. Cuts 4" to 2/1-4" steel pipes efficiently.**

- High cutting efficiency achieved by: increasing the cutting speed and minimizing the reduction in blade speed
- Easy installation/removal of blade
- Easy blade track adjustment simply by turning a screw
- Adjustable stopper plate
- Variable speed control by dial

<b>Capacity</b>	Square: 127 x 127 mm (5 x 5")
<b>Blade Speed</b>	0 - 3.2 m/min
<b>Blade Size</b>	Length: 1,140 mm (45") / Width: 13 mm (1/2") Thickness: 0.5 mm (0.02")
<b>Dimensions (L x W x H)</b>	510 x 218 x 314 mm
<b>Net weight</b>	5.9 kg (without battery)

**Standard Equipment:** Hex Wrench

AVAILABLE VARIANTS

<b>4.0Ah</b>	<b>"Z" VARIANT</b>
<b>PB002G M2</b> INCLUDES 2 BATTERIES / 1 CHARGER / PLASTIC CASE	<b>PB002G Z</b> TOOL ONLY (DOES NOT INCLUDE BATTERY / CHARGER / CARRYING CASE)

DPB180
18V |

Cordless Portable Band Saw

**Light weight and well balanced tool design.**

- Electronic current limiter for overload protection (with Warning Lamp).
- Single-Light LED Job Light with afterglow function.
- Speed Preset Dial allows to adjust the blade speed to suit workpiece material or desired finish.
- Ergonomically designed handle with elastomer surface for anti-slip, firm grip.
- Bumper protects tool body when putting down on the floor.

<b>Capacity</b>	Round workpiece (dia) : 120mm (4-3/4") Rectangular workpiece Without stand: 120x120mm (4-3/4"x4-3/4")
<b>Blade speed</b>	84m (275 ft) - 162m (530 ft) / min
<b>Dimensions (L x W x H)</b>	523x231x313mm (20-5/8"x9-1/8"x12-3/8")
<b>Net weight</b>	6.4kg

**Standard Equipment:** Hex wrench.

AVAILABLE VARIANTS

"Z" VARIANT

<b>DPB180 Z</b> TOOL ONLY (DOES NOT INCLUDE BATTERY / CHARGER OR CARRY CASE)
--

DPB183
18V |

Cordless Portable Band Saw

**High power & Compact design due to brushless motor. Stable cutting with highly rigid aluminium structure**

- Constant speed control minimizes the reduction in blade speed to provide stable cutting
- Easy blade track adjustment simply by turning the screw
- Lightweight design with excellent balance
- Easy installation / removal of blade
- Variable speed control by dial
- Catch bracket protects the tool body from damage by hitting against workpiece.

<b>Capacity</b>	Round: 66 mm Square: 66 x 66 mm
<b>Blade Speed</b>	0 - 3.2 m/s
<b>Blade Size</b>	Length: 835 mm / Width: 13 mm / Thickness: 0.5 mm
<b>Dimensions (L x W x H)</b>	392x174x242 mm
<b>Net weight</b>	3.9 kg

**Standard Equipment:** Hex wrench

AVAILABLE VARIANTS

"Z" VARIANT

<b>DPB183 Z</b> TOOL ONLY (DOES NOT INCLUDE BATTERY / CHARGER OR CARRY CASE)
--

2107FK

Portable Band Saw

**Large 4/3-4" x 4/3-4" capacity with excellent tool balance**

- Bridge construction of aluminum frame and motor housing makes the machine more durable
- Built-in fluorescent job light for clear view of ink line even in dark places
- Switch for fluorescent job light is independent of main switch
- Preset dial for speed adjustment enables you to obtain suitable cutting speed for each material



<b>Continuous rating Input</b>	710W
<b>Capacity</b>	<b>Round work piece (dia.):</b> 120mm (4-3/4") <b>Rectangular work piece (Without stand):</b> 120 x 120mm (4-3/4" x 4-3/4")
<b>Blade speed</b>	60m (200 ft) - 105m (350 ft) /min
<b>Dimensions (L x W x H)</b>	508 x 188 x 256mm (20" x 7-3/8" x 10-1/8")
<b>Net weight</b>	6.0kg (13.1lbs)
<b>Power supply cord</b>	2.5m (8.2ft)

**Standard Equipment:** Carbon Steel Band Saw Blade (18 teeth per inch) 1 pc, Hex. Wrench

**CA5000XJ** 118mm (4-5/8") 

**Aluminum Groove Cutter**

Tool be used with guide Rail

**Developed for cutting grooves in aluminum composite materials**

- Cutter blade for 90 degrees V shaped groove enables you to cut grooves in aluminum composite materials (e.g. exterior wall panels).
- Ideal for processing aluminum composite material
- User-friendly blade cover design for easy blade change
- Two in one; Also can be used as a plunge cut circular saw.





<b>Continuous rating input</b>	1,300W
<b>Blade</b>	Type : Cutter blade / TCT saw blade
<b>Blade Diameter</b>	118mm
<b>Hole Diameter</b>	20mm
<b>Max cutting capacity with Cutter blade</b>	with Guide rail: 11mm (7/16")
<b>Max cutting capacity with TCT Saw blade</b>	with Guide rail: 36mm (1-7/16") without Guide rail: 41mm (1-5/8")
<b>No Load Speed (RPM)</b>	2,200-6,400
<b>Dimensions (L x W x H)</b>	346x250x250mm
<b>Net weight</b>	5.1kg (11.3lbs)
<b>Power supply cord</b>	2.5m (8.2ft)

**Standard Equipment:** Cutter blade, Plate, Hex wrench

**LC1230** 305mm (12") 

**Metal Cutting Saw**

**Fast cuts in light pipe, angle iron, tubing, conduit and channels.**

- Just release lever to adjust cutting angle; no tools required.
- Carbide tipped blade lasts longer than abrasive wheel; cuts clean, accurate and virtually burr free.



<b>Continuous rating Input</b>	1,750W
<b>Blade diameter</b>	305mm
<b>Capacity</b>	at 0 degrees: 115mm (4-1/2") at 0 degrees: 75mm x 150mm (2-15/16" x 5-7/8") at 45 degrees: 90mm (3-1/2") at 45 degrees: 85 x 85mm (3-5/16" x 3-5/16")
<b>No load speed</b>	1,300rpm
<b>Dimensions (L x W x H)</b>	516mm x 306mm x 603mm (20-1/4" x 12" x 23-3/4")
<b>Net weight</b>	19.3kg (42.5lbs)
<b>Power supply cord</b>	2.5m (8.2ft)

**Standard Equipment:** Carbide-tipped Saw Blade (for mild steel), Socket Wrench, Safety Goggles.

**DLW140** - 355mm 

**Cordless Portable Cut-off**



**Cutting work Amount**

**130 cuts**  
75 x 45mm, T: 0.8mm metal stud BL1850B x2

**World's First Cordless Portable Cut-off**

- Fastens 380 M22 (7/8") torque shear bolts with two 18V 6.0 Ah batteries
- Load status indicator
- Tool-less replacement of abrasive cut-off wheel
- Toolless adjustment of guide plate
- Large spark guard





<b>Wheel Diameter</b>	355 mm (14")
<b>Hole Diameter</b>	25.4 mm (1")
<b>No Load Speed (RPM)</b>	3,800
<b>Capacity at 90°</b>	Round: 127 mm (5") Rectangular: 115x130 mm / Rectangular: 102x194 mm Rectangular: 70x233 mm
<b>Capacity at 45°</b>	Round: 127 mm (5") / Rectangular: 115x103 mm
<b>Vibration Level</b>	2.5 m/s²
<b>Sound Pressure Level</b>	103 dB(A)
<b>Sound Power Level</b>	115 dB(A)
<b>Dimensions (L x W x H)</b>	537x290x640 mm
<b>Net weight</b>	17.8 kg

**AVAILABLE VARIANTS**

6.0Ah	3.0Ah	"Z" VARIANT
<b>DLW140 PG2</b> INCLUDES 2 BATTERIES / 1 TWO PORT CHARGER ONLY	-	<b>DLW140 Z</b> TOOL ONLY (DOES NOT INCLUDE BATTERY / CHARGER)

**LW1400** 355mm (14") 

**Portable Cut-off**

**Powerful 2,200W motor 355mm (14") Portable Cut-off, with tool-less functions**

- Replacement of Abrasive cut-off wheel and adjustment of Guide plate can be done without any tools.
- Large spark guard prevents backward scattering of spark.
- Quick release vise



<b>Continuous rating input</b>	2,200W
<b>Wheel size</b>	Diameter : 355mm (14") Hole diameter: 25.4mm (1") Thickness: 3mm (1/8")
<b>No load speed (rpm)</b>	3,800
<b>Capacity</b>	Round stock: 127mm (5") Rectangular stock (H x W) : 102x194mm
<b>Dimensions (L x W x H)</b>	530x295x640mm (20-7/8" x 11-5/8" x 25-1/4")
<b>Net weight</b>	17.0kg (37.5lbs)
<b>Power supply cord</b>	2.5m (8.2ft)

**CUTTING CAPACITIES (mm)**

90°	45°	90°	45°	90°	45°	90°	45°
115	115	115	115	119 x 106	137	100	100

**Standard Equipment:** Abrasive cut-off wheel, Socket wrench

- DRILLING / FIXING
- CONCRETE DRILLING / DEMOLITION
- MIXING / STIRRING
- CUTTING (CONCRETE / METAL)
- GRINDING
- SANDING / POLISHING
- SAWING
- MULTI-TOOL
- ROUTERS / PLANERS
- NAILERS / STAPLERS
- HEAT GUN / LASER
- CLEANING
- OPE
- JOBSITE TOOLS
- SPECIALTY TOOLS
- HAND TOOLS / COMBINATION SET
- TOOL HOLDERS AND POUCHES / MAKPAC SYSTEM

- DRILLING / FIXING
- CONCRETE DRILLING / DEMOLITION
- MIXING / STIRRING
- CUTTING (CONCRETE / METAL)

**LW1401** 355mm (14")

**Portable Cut-off**

**Powerful 2,200W motor 355mm (14") Portable Cut-off, successor to 2414NB**

- Quick release vise.
- Carry handle for easy transport to job site.

**203mm**

<b>Continuous rating input</b>	2,200W
<b>Wheel size</b>	Diameter : 355mm (14") Hole diameter: 25.4mm (1") Thickness: 3mm (1/8")
<b>No load speed (rpm)</b>	3,800
<b>Capacity</b>	Round stock: 127mm (5") Rectangular stock (H x W) : 70x233mm
<b>Dimensions (L x W x H)</b>	500x290x620mm (19-3/4"x11-3/8"x24-3/8")
<b>Net weight</b>	16.6kg (36.6lbs)
<b>Power supply cord</b>	2.5m (8.2ft)

**CUTTING CAPACITIES (mm)**

○		□		▭		└┘	
90°	45°	90°	45°	90°	45°	90°	45°
115	115	115	115	119 x 106	137	100	

**Standard Equipment:** Abrasive Cut-off Wheel, Socket Wrench.

- GRINDING
- SANDING / POLISHING
- SAWING
- MULTI-TOOL

**2414** 355mm (14")

**Portable Cut-off**

**Guide plate adjusts 45 degrees; 3 way adjustment for material holding.**

- The wheel support's unique ability prevents it from loading and enhances cut-off performance.
- Quick vise for fast clamping of various size materials.

**153mm**

<b>Continuous rating Input</b>	1,450W
<b>Wheel dia.</b>	355mm (14")
<b>Hole dia.</b>	25.4mm (1")
<b>No load speed</b>	3,800rpm
<b>Dimensions</b>	500mm x 280mm x 600mm
<b>(L x W x H)</b>	(19-11/16" x 11" x 23-5/8")
<b>Net weight</b>	16.3kg (36lbs)
<b>Power supply cord</b>	2.5m (8.2ft)

**CUTTING CAPACITIES (mm)**

○		□		▭		└┘	
90°	45°	90°	45°	90°	45°	90°	45°
115	115	115	115	119 x 106	137	100	

**Standard Equipment:** Abrasive Cut-off Wheel, Socket Wrench.

- ROUTERS / PLANERS

- NAILERS / STAPLERS
- HEAT GUN / LASER
- CLEANING
- OPE
- JOBSITE TOOLS
- SPECIALTY TOOLS
- HAND TOOLS / COMBINATION SET
- TOOL HOLDERS AND POUCHES / MAKAPAC SYSTEM

**2414B** 355mm (14")

**Portable Cut-off**

**Unique twin pivoting cutting head for increased cutting capacity.**

- Quick release vise for secure stock retention and fast repeated cut-offs.
- Lock off button helps prevent accidental starting.
- Adjustable depth stop for precise, repeatable cutting depth.
- Guide plate adjusts 45 degrees, 3 way adjustment for material holding.

**203mm**

<b>Continuous rating Input</b>	220V: 2,000W / 127V: 1,650W
<b>Wheel dia.</b>	355mm (14")
<b>Hole dia.</b>	25.4mm (1")
<b>No load speed</b>	3,800rpm
<b>Dimensions</b>	500mm x 280mm x 600mm
<b>(L x W x H)</b>	(19-11/16" x 11" x 23-5/8")
<b>Net weight</b>	15.9kg (35lbs)
<b>Power supply cord</b>	2.5m (8.2ft)

**CUTTING CAPACITIES (mm)**

○		□		▭		└┘	
90°	45°	90°	45°	90°	45°	90°	45°
115	115	122	106	70 x 240	139	100	

**Standard Equipment:** Abrasive Cut-Off Wheel, Socket Wrench.

**2416S** 405mm (16")

**Portable Cut-off**

**405mm (16") blade for more cutting capacity.**

- Good reputation for pipe and angle iron cut-off work.
- Quick release vise for secure stock retention and fast repeated cut-offs.

**153mm**

<b>Continuous rating Input</b>	1,430W
<b>Wheel dia.</b>	405mm (16")
<b>Hole dia.</b>	25.4mm (1")
<b>No load speed</b>	2,300rpm
<b>Dimensions</b>	610mm x 265mm x 535mm
<b>(L x W x H)</b>	(24" x 10-3/8" x 21")
<b>Net weight</b>	19.2kg (42.3lbs)
<b>Power supply cord</b>	2.5m (8.2ft)

**CUTTING CAPACITIES (mm)**

○		□		▭		└┘	
90°	45°	90°	45°	90°	45°	90°	45°
115	115	120	110	80 x 230	150	110	

**Standard Equipment:** Abrasive Cut-Off Wheel, Socket Wrench.

**DSC251**

18V | **LXT**

**Cordless Steel Rod Cutter**



**Ideal for edge cutting of threaded rods and rebars**

- Fine edge cutting: Rebars can be cut at 3.5 mm from the corner of lattice for both vertically and horizontally;
- Threaded rods can be cut also at 3.5 mm from the ground/surface
- Less damage to the threaded rods and therefore nuts can be installed without removing burrs
- ADT (Automatic Torque Drive Technology) adjusts speed and torque during operation for optimum performance
- High power with Brushless Motor
- Flangeless blade can be equipped

**Excellent edge cutting**  
3.5mm from the ground/surface

Smooth Nut mounting without deburring



**Accessories**



For Model	Type	Size	Part no:
DSC251	TCT Saw Blade	110mm	<b>SC09003260</b>
DSC251	Efficut Saw Blade	110mm	<b>E-11097</b>

Spacer part # SC09030550 used with DSC250 to fit the above accessory



<b>Blade Diameter</b>	110 mm
<b>Cutting Capacity</b>	Dia.: 10 - 25 mm
<b>No Load Speed (RPM)</b>	2,200
<b>Vibration Level</b>	Cutting Rebar: 2.5 m/s <sup>2</sup> or less
<b>Dimensions (L x W x H)</b>	471x137x139 mm
<b>Net weight</b>	4.0 kg

**Standard Equipment:** Side Grip, Hex Wrench

AVAILABLE VARIANTS

**"Z" VARIANT**

**DSC251 ZK**  
TOOL + CARRY CASE  
(DOES NOT INCLUDE BATTERY / CHARGER)

**DSC163**

18V | **LXT**

**Cordless Steel Rod Cutter**



**Brushless Motor for faster rebar cutting**

- Quick and effortless rebar cutting for maximum jobsite productivity and safety
- Spark free cutting, Ideal for cutting steel bars laid in concrete slab
- Up to 150 cuts of 20 mm rebar with a 6.0Ah LXT battery
- Cutting capacity range of 3 - 20 mm standard rebar
- 4-Way rotatable cutting blade provides up to 4,000 cuts before needing to be replaced
- Cutting head rotates 360° to accommodate different cutting positions.



**Accessories**



Type	Part no:
Cutter blade set	<b>SC09002470</b>



<b>Capacity</b>	Dia: 3 - 16 mm
<b>Cutting Speed (sec)</b>	2.8 sec
<b>Dimensions (L x W x H)</b>	360x108x276 mm
<b>Net weight</b>	6.9 kg

**Standard Equipment:** Wrench, Hex Wrench

AVAILABLE VARIANTS

**"Z" VARIANT**

**DSC163 ZK**  
TOOL + CARRY CASE  
(DOES NOT INCLUDE BATTERY / CHARGER)

DRILLING / FIXING

CONCRETE DRILLING / DEMOLITION

MIXING / STIRRING

CUTTING (CONCRETE / METAL)

GRINDING

SANDING / POLISHING

SAWING

MULTI-TOOL

ROUTERS / PLANERS

NAILERS / STAPLERS

HEAT GUN / LASER

CLEANING

OPE

JOBSITE TOOLS

SPECIALTY TOOLS

HAND TOOLS / COMBINATION SET

TOOL HOLDERS AND POUCHES / MAKPAC SYSTEM

- DRILLING / FIXING
- CONCRETE DRILLING / DEMOLITION
- MIXING / STIRRING
- CUTTING (CONCRETE / METAL)
- GRINDING
- SANDING / POLISHING
- SAWING
- MULTI-TOOL
- ROUTERS / PLANERS
- NAILERS / STAPLERS
- HEAT GUN / LASER
- CLEANING
- OPE
- JOBSITE TOOLS
- SPECIALTY TOOLS
- HAND TOOLS / COMBINATION SET
- TOOL HOLDERS AND POUCHES / MAKPAC SYSTEM

DSC121
18V | **LXT**

Cordless Threaded Rod Cutter



High cutting power and speed achieved by BL motor

**Powerful BL motor**  
Cuts M12 steel threaded rod in 3 seconds



**Balance stand**  
helps you cut thread horizontally





**Accessories**

**Cutter blade set**



Type	Size	Part no:
Mild Steel - Stainless Steel	M12	<b>SC09002720</b>
Mild Steel - Stainless Steel	M10	<b>SC09002710</b>
Mild Steel - Stainless Steel	M8	<b>SC09002700</b>

**Clean cut surface**  
Burr-free cuts allow for easy nut tightening.



**Capacity** Steel: 8 - 12 mm (5/16" - 1/2")

**Cutting Speed (sec)** 3.0

**Vibration Level** 2.5 m/s<sup>2</sup> or less

**Sound Pressure Level** 85 dB(A)

**Sound Power Level** 96 dB(A)

**Dimensions (L x W x H)** 212x323x260 mm

**Net weight** 6.0 kg

**Standard Equipment:** Hex Wrench



AVAILABLE VARIANTS

"Z" VARIANT

**DSC121 ZK**  
TOOL + CARRYCASE ONLY  
(DOES NOT INCLUDE BATTERY / CHARGER)

DSC102
18V | **LXT**

Cordless Threaded Rod Cutter





Compact & lightweight provides increased comfort for overhead cutting

- No spark, no deburring required and low noise
- Nut can be immediately mounted.

Performs stable cutting even on the floor





◀ [ 1 ]  
Size of threaded rod  
W3/8, M10



◀ [ 2 ]  
Size of threaded rod  
M8, M6



<b>Capacity</b>	Steel: M6 - M10 mm (W3/8")
<b>Vibration Level</b>	cutting threaded stainless steel rod (rod size W3/8): 2.5 m/s <sup>2</sup> or less
<b>Dimensions (L x W x H)</b>	199x103x308 mm
<b>Net weight</b>	3.3 kg

**Standard Equipment:** Depth Gauge, Hex Wrench,



AVAILABLE VARIANTS

"Z" VARIANT

**DSC102 ZJ**  
TOOL + MAKPACK CASE ONLY  
(DOES NOT INCLUDE BATTERY / CHARGER)

SC103D
12V MAX | **CXT**

Cordless Threaded Rod Cutter

Compact & lightweight provides increased comfort for overhead cutting

- No spark, no deburring required and low noise
- Nut can be immediately mounted.

Performs stable cutting even on the floor (same as LXT tool DSC102)



<b>Max Cutting Capacity</b>	Mild Steel: M10 Stainless Steel: W3/8
<b>Min. Cutting Length</b>	20 mm
<b>Work Amount (pcs)</b>	M10 (Mild Steel) w/BL1041B: 550
<b>Dimensions (L x W x H)</b>	180x107x289 mm
<b>Net weight</b>	2.8 kg

**Standard Equipment:** Depth Gauge, Hex Wrench,

AVAILABLE VARIANTS

"Z" VARIANT

**SC103D ZJ**  
TOOL + MAKPACK CASE ONLY  
(DOES NOT INCLUDE BATTERY / CHARGER)

**Accessories**

**Long life cutter blade**  
High rigidity  
Double-edged blade



**Clean cut surface**  
Burr-free cuts allow for easy nut tightening.



Type	Size	Part no:
Mild Steel - Stainless Steel	M6	<b>199087-8</b>
Mild Steel - Stainless Steel	M8	<b>199085-2</b>
Mild Steel	M10	<b>199083-6</b>



**DPP200**

18V | **LXT**

**Cordless Hole Puncher**



**More reliable sturdy aluminium casing attachment**

- Punches up to 20 mm holes through steel plate up to 8 mm thick
- Versatile punch is applicable to a variety of materials: mild steel, stainless steel, channel, aluminium and copper.
- Provides high-speed punching of round/oblong holes through structural steels such as flat bar, angle or channel.



<b>Capacity</b>	Steel: 20 mm (13/16") Stainless Steel: 20 mm (13/16")
<b>Max Throat Depth</b>	40 mm (1-9/16")
<b>Dimensions (L x W x H)</b>	417x127x315 mm
<b>Net weight</b>	10.5 kg

**Standard Equipment:** Hex Wrench, Spanner, Bar for fastening nuts, Grip

**AVAILABLE VARIANTS**

**"Z" VARIANT**

**DPP200 ZK**  
TOOL ONLY + CARRY CASE (DOES NOT INCLUDE BATTERY / CHARGER)

**Automatic punch return**

Automatic punch return: After a punching cycle is completed, hydraulic pressure automatically pulls off the punch from workpiece and returns it to the initial position to enable efficient continuous hole punching

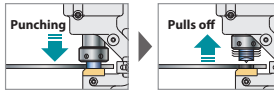

**Flat bar**



Max: 80mm x t8  
(Center punching)

**Angle**



Min: 40mm x 40mm x t3  
Max: 80mm x 80mm x t8

**Motor section swivels full 360 degrees**

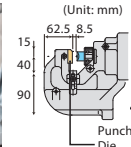

**Channel**



Min: 75mm x 40mm  
Max: 100mm x 50mm  
Flat Punching

**Accessories**

**Work stand**  
SC03801080



**Slide stopper**  
SC03300790



**Hydraulic Oil**  
SC00000106  
35mL



**Hydraulic Oil**  
SC00000270  
1,000mL



**DJS101 1.0 mm (19 Ga)**

**Cordless Straight Shear**



**High cutting capacity cordless 1.0mm metal shear**

- Easy curve cutting
- Straight design provides more control and high maneuverability for easy cutting operation
- Minimum outside cutting radius of 30 mm for close right or left curve cuts with a smooth edge
- Anti-restart function with warning lamp



<b>Capacity</b>	Steel up to 400 N/mm <sup>2</sup> : 1.0 mm Steel up to 600 N/mm <sup>2</sup> : 0.7 mm Aluminum up to 200 N/mm <sup>2</sup> : 2.5 mm
<b>Strokes Per Minute (SPM)</b>	4,300
<b>Dimensions (L x W x H)</b>	364x78x118 mm
<b>Net weight</b>	2.2 kg

**Standard Equipment:** Hex Wrench

**AVAILABLE VARIANTS**

**5.0Ah**

**DJS101 RTJ**  
INCLUDES 2 BATTERIES / 1 CHARGER /  
MAKPAC CONNECTOR CASE

**"Z" VARIANT**

**DJS101 Z**  
TOOL ONLY  
(DOES NOT INCLUDE BATTERY / CHARGER  
OR CARRY CASE)

**DJS200 2.0 mm (14 Ga)**

**Cordless Metal Shear**



**Tool-free shear head rotates 360° for increased comfort in various cutting positions**

- Cutting head is machined from precisely milled steel to ensure blades cut clean and straight
- Maximum cutting capacity in steel 2.0mm
- Compact and Lightweight Design (345mm long) (1.9kg without battery)

**Specifications:-**



<b>Capacity</b>	Steel: 2.0 mm (14 gauge) Stainless Steel: 1.6 mm (16 gauge)
<b>Strokes Per Minute (SPM)</b>	0 - 3,000
<b>Dimensions (L x W x H)</b>	345 x 79 x 207 mm
<b>Net weight</b>	2.5 kg

**Standard Equipment:** Hex Wrench, Belt Clip

**AVAILABLE VARIANTS**

**"Z" VARIANT**

**DJS200 Z**  
TOOL ONLY  
(DOES NOT INCLUDE BATTERY / CHARGER OR CARRY CASE)

DRILLING / FIXING

CONCRETE DRILLING / DEMOLITION

MIXING / STIRRING

CUTTING (CONCRETE / METAL)

GRINDING

SANDING / POLISHING

SAWING

MULTI-TOOL

ROUTERS / PLANERS

NAILERS / STAPLERS

HEAT GUN / LASER

CLEANING

OPE

JOB SITE TOOLS

SPECIALTY TOOLS



HAND TOOLS / COMBINATION SET

TOOL HOLDERS AND POUCHES / MAKPAC SYSTEM

- DRILLING / FIXING
- CONCRETE DRILLING / DEMOLITION
- MIXING / STIRRING
- CUTTING (CONCRETE / METAL)
- GRINDING
- SANDING / POLISHING
- SAWING
- MULTI-TOOL
- ROUTERS / PLANERS
- NAILERS / STAPLERS
- HEAT GUN / LASER
- CLEANING
- OPE
- JOBSITE TOOLS
- SPECIALTY TOOLS
- HAND TOOLS / COMBINATION SET
- TOOL HOLDERS AND POUCHES / MAKPAC SYSTEM

DJS131 1.3 mm (18 Ga) 18V |

**Cordless Metal Shear**

**Tool-free shear head rotates 360° for increased comfort in various cutting positions**

- The cutting edge of the blade is offset against the central axis
- Designed for curved cuts and corrugated roofing in steel up to 1.3mm (able perform curved cuts)
- Compact and Lightweight Design (332mm long)



<b>Capacity</b>	Steel: 1.3 mm (18 gauge) Stainless Steel: 1.0 mm (20 gauge)
<b>Strokes Per Minute (SPM)</b>	0 - 3,000
<b>Dimensions (L x W x H)</b>	332 x 79 x 252 mm
<b>Net weight</b>	1.6 kg (without battery)

**Standard Equipment:** Hex Wrench, Belt Clip

AVAILABLE VARIANTS

"Z" VARIANT

**DJS131 Z**  
TOOL ONLY  
(DOES NOT INCLUDE BATTERY / CHARGER OR CARRY CASE)

DJS800 13 mm 18V |

**Cordless Cement Shear**



**Tool-free shear head rotates 360° for increased comfort in various cutting positions**

- Cutting head is machined from precisely milled steel to ensure blades cut clean and straight
- Maximum cutting capacity in cement fiber siding 13mm
- Compact and Lightweight Design (345mm long) (1.9kg without battery)



<b>Max Cutting Capacity</b>	13 mm (1/2")
<b>Strokes Per Minute (SPM)</b>	0 - 3,000
<b>Dimensions (L x W x H)</b>	379 x 79 x 216 mm
<b>Net weight</b>	1.9 kg (without battery)

**Standard Equipment:** Hex Wrench, Belt Clip

AVAILABLE VARIANTS

"Z" VARIANT

**DJS800 Z**  
TOOL ONLY  
(DOES NOT INCLUDE BATTERY / CHARGER OR CARRY CASE)

- NAILERS / STAPLERS
- HEAT GUN / LASER
- CLEANING
- OPE
- JOBSITE TOOLS
- SPECIALTY TOOLS
- HAND TOOLS / COMBINATION SET
- TOOL HOLDERS AND POUCHES / MAKPAC SYSTEM

JS1601 1.6mm (16Ga)

**Straight Metal Shear**



**Ingenious aesthetic design provides more control and high maneuverability**

- Mainly for Straight Cutting.
- Ergonomically best possible barrel grip for straight shear.
- Rear cover ergonomically tapered for easy grip.



<b>Continuous rating Input</b>	380W
<b>Capacity</b>	Steel up to 400 N/mm <sup>2</sup> :1.6mm Steel up to 600 N/mm <sup>2</sup> :1.2mm Steel up to 800 N/mm <sup>2</sup> :0.8mm Aluminum up to 200 N/mm <sup>2</sup> : 2.5mm
<b>Min cutting radius</b>	250mm (9-7/8")
<b>Strokes per min.</b>	4,500
<b>Dimensions (L x W x H)</b>	320x70x78mm (12-5/8"x2-3/4"x3-1/16")
<b>Net weight</b>	1.4kg (3.1lbs)
<b>Power supply cord</b>	2.5m (8.2ft)

**Standard Equipment:** Hex Wrench, Thickness Gauge

JS1602 1.6mm (16Ga)

**Metal Shear**



**Slim motor housing and rear cover provides more control and better maneuverability.**

- Conveniently located slide switch for one hand operation.



<b>Continuous rating Input</b>	380W
<b>Capacity</b>	Steel up to 400 N/mm <sup>2</sup> : 1.6mm Steel up to 600 N/mm <sup>2</sup> : 1.2mm Steel up to 800 N/mm <sup>2</sup> : 0.8mm Aluminum up to 200 N/mm <sup>2</sup> : 2.5mm
<b>Min. cutting radius</b>	30mm (1-3/16")
<b>Strokes per minute (spm)</b>	4,000
<b>Dimensions (L x W x H)</b>	255x74x146mm (10"x2-15/16"x5-3/4")
<b>Net weight</b>	1.6kg (3.4lbs)
<b>Power supply cord</b>	2.5m (8.2ft)

**Standard Equipment:** Hex wrench

**JS3201** 3.2mm



**Metal Shear**



**Robust design with elastomer coated handle provides easy operation**

- Protector equipped under the body prevents from scratching by metal cutting piece, and enables smooth cutting.
- On-tool storage for Hex wrench



<b>Continuous rating Input</b>	710W
<b>Capacity</b>	Steel up to 400 N/mm <sup>2</sup> : 3.2mm Steel up to 600 N/mm <sup>2</sup> : 2.5mm Steel up to 800 N/mm <sup>2</sup> : 1.5mm Aluminum up to 200 N/mm <sup>2</sup> : 4.0mm
<b>Min. cutting radius</b>	50mm (2")
<b>Strokes per minute (spm)</b>	1,600
<b>Dimensions (L x W x H)</b>	213x90x239mm (8-3/8"x3-1/2"x9-3/8")
<b>Net weight</b>	3.4kg (7.4lbs)
<b>Power supply cord</b>	2.5m (8.2ft)

**Standard Equipment:** Shear blades set, Hex wrench, Thickness gauge

**DJN161**

18V | **LXT**

**Cordless Nibbler**



**18v Li-ion Cordless 1.6 mm (16 Ga) Nibbler ideal for cutting roofing sheet metal at thicknesses up to 16 gauge**

- Makita-built motor delivers 1,900 SPM for faster and smooth cutting
- Die holder rotates 360° to meet demands of cutting direction
- Convenient chip disposal is below cutting material to minimize damage to cutting surface
- Cutting radius: inner edge 45 mm (1-3/4"); outer 50 mm (2")



<b>Capacity</b>	Mild Steel up to 400 N/mm <sup>2</sup> : 1.6 mm Stainless Steel up to 600 N/mm <sup>2</sup> : 1.2 mm Aluminum up to 200 N/mm <sup>2</sup> : 2.5 mm
<b>Min. cutting radius</b>	Inside edge : 45 mm (1-3/4") Outside edge : 50 mm (2")
<b>Strokes Per Minute (SPM)</b>	1,900
<b>Dimensions (L x W x H)</b>	313x78x189 mm
<b>Net weight</b>	2.3 kg

**Standard Equipment:** Hex Wrench, Wrench, Punch, Die

**AVAILABLE VARIANTS**

3.0Ah

**DJN161 RFE**  
INCLUDES 2 BATTERIES / 1 CHARGER / PLASTIC CASE

**JN1601** 1.6mm



**Nibbler**



**Precise, burr-free curved and straight cuts from slim, yet powerful performer**

- Cuts flat and corrugated sheet metal with the same die.
- Die rotates 360 degrees, large 1/4" stroke.
- Extremely light (weighs only 1.6kg).
- Built-in thickness gauge for convenience



<b>Continuous rating Input</b>	550W
<b>Capacity</b>	Steel up to 400 N/mm <sup>2</sup> : 1.6mm Steel up to 600 N/mm <sup>2</sup> : 1.2mm Steel up to 800 N/mm <sup>2</sup> : 0.8mm Aluminum up to 200 N/mm <sup>2</sup> : 2.5mm
<b>Min. cutting radius</b>	Outside edge : 50mm (2") Inside edge : 45mm (1-3/4")
<b>Strokes per min.</b>	2,200
<b>Overall length</b>	261mm (10-1/4")
<b>Net weight</b>	1.6kg (3.6lbs)
<b>Power supply cord</b>	2.0m (6.6ft)

**Standard Equipment:** Hex Wrench, Wrench, Punch, Die

**JN3201** 3.2mm



**Nibbler**



**Robust design with elastomer coated handle provides easy operation.**

- Common blade with JN3200
- On-tool storage for Hex wrench



<b>Continuous rating Input</b>	710W
<b>Capacity</b>	Steel up to 400 N/mm <sup>2</sup> : 3.2mm Steel up to 600 N/mm <sup>2</sup> : 2.5mm Steel up to 800 N/mm <sup>2</sup> : 1.0mm Aluminum up to 200 N/mm <sup>2</sup> : 3.5mm
<b>Min. cutting radius</b>	Outside edge: 128mm (5-1/16") Inside edge: 120mm (4-3/4")
<b>Strokes per minute (spm)</b>	1,300
<b>Dimensions (L x W x H)</b>	225x90x254mm (8-7/8"x3-1/2"x10")
<b>Net weight</b>	3.4kg (7.4lbs)
<b>Power supply cord</b>	2.5m (8.2ft)

DRILLING / FIXING

CONCRETE DRILLING / DEMOLITION

MIXING / STIRRING

CUTTING (CONCRETE / METAL)

GRINDING

SANDING / POLISHING

SAWING

MULTI-TOOL

ROUTERS / PLANERS

NAILERS / STAPLERS

HEAT GUN / LASER

CLEANING

OPE

JOBSITE TOOLS

SPECIALTY TOOLS

HAND TOOLS / COMBINATION SET

TOOL HOLDERS AND POUCHES / MAKPAC SYSTEM

# Power Cutter Accessories

## Abrasive cut-off wheel (For power cutter)

- Always ensure the max RPM of the wheel matches the power cutter



Size (mm)	Grit	Max. RPM	Pcs / Pkg	Part No.
230 x 3.0 x 22.23	Metal	6650 min <sup>-1</sup>	1	B-62913
300 x 3.5 x 20 mm	Metal	5100 min <sup>-1</sup>	1	B-70792
350 x 4.0 x 25.4 mm	Metal	5500 min <sup>-1</sup>	1	B-70839
350 x 4.0 x 25.4 mm	Stone	5500 min <sup>-1</sup>	1	B-70823
355 x 4.3 x 25.4 mm	Metal	5500 min <sup>-1</sup>	5pcs set	■ E-12790-5

## Diamond Wheel (For power cutter)

- A - Ideal for cordless power cutter
- B - DiaDuran - Long Last runners blades
- C - Quasar premium universal application 3D Grid diamond blade

D	T	X	H	D	COLOR	MATERIALS									FOR MODEL	TYPE	PART NO.
						1	2	3	4	5	6	7	8	9			
230	3.2	13	22.23	-	Green	●	●		●	○					DCE090	A	E-02967
300	2.8	5	25.4	20	Silver	○	●		●	●					EK6100, EK7650H	-	A-86773
305	2.8	6.5	25.4	20	Silver	○	●		●	●					EK6100, EK7650H	-	A-89349
305	3.0	7.5	30	*	Blue		●		●	●	○				EK6100 / 4112HS, EK7650H	-	A-02490
350	3.2	5	25.4	20	Silver	○	●		●	●					EK7301, EK7651H	-	A-87317
350	2.88	6	25.4	-	White	Asphalt									EK7301, EK7651H	-	966244011
350	3.0	-	25.4	-	Green	Long life in abrasive materials									EK7301, EK7651H	-	966244030
350	3.3	7	25.4	-	Silver	Concrete, Stone, Brick									EK7301, EK7651H	B	966344020
350	3.0	6.5	25.4	-	Silver	Asphalt									EK7301, EK7651H	B	966344010
355	2.8	10	25.4	-	Green	●	●		●	○					CE001G, CE002G, EK7301, EK7651H	A	E-12996
400	3.0	12	25.4	20	Red	●	●	●	●	●	●				EK8100	C	B-13471

\* 20, 22.23, 25.4 (Ring size)

## Diamond Wheel for Rescue (For power cutter)

- A - Vacuum Brazed Rescue Blade | B - Rescue Force

D	T	X	H	d	Color	For Material									For Model	Type	Part No.		
						1	2	3	4	5	6	7	8	9					
230	3.1	4	22.23	-	RED	○	○	○	○	○	○	○	○	○	○	○	230mm Grinder & Power Cutter	A	B-55326
350	3.4	4	25.4	20	RED	○	○	○	○	○	○	○	○	○	○	○	355mm Power Cutter	A	B-55348
350	3.0	-	25.4	-	GOLD	Light metal, Concrete									355mm Power Cutter	B	966544060		

## Trolley kit (For power cutter)

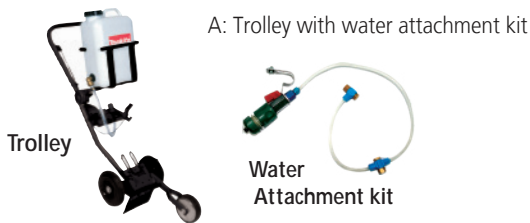

A: Trolley with water attachment kit

Trolley	For Models	Type	Part no
DT2010	EK7301	A	394369600
DT4000	EK7650H / EK7651H	A	394369610
Water attachment kit	EK7301	-	394365602

## Pressurised Metal Water Tank (For power cutter)

The Pressurized Water Tank makes applications like wet cutting possible in areas where water is limited or unavailable. Portable and Easy to Operate



Max Operation Pressure:	Max water capacity	Part no
6 Bar	10 Litres	957802600

## Compact Cut-off Accessories



	Size (mm)	Grit	Material	Pcs / Pkg	Part No.
A	Thin cut-off wheel	76 x 1.0 x 10mm	Metal	5	■ D-74815-5
B	Tungsten carbide grit blade	76 x 10mm	Plaster Board, PVC, Epoxy	1	■ D-74837
C	Diamond wheel	76 x 1.4 x 10mm	Tile	1	■ D-77263

## Metal Cutter - Saw Blades

### Efficut Saw blades for Metal Cutter



Designed with the Efficut specific tip shape that allows for increased cutting speed, smoother cuts and more cuts per charge when paired with your Makita cordless metal cutting saws.

- The Efficut saw blades are faster compared to standard saw blades.
- The new tip design reduces contact with the material, increases efficiency of release waste and has a sharper bevel angle.
- Cuts are more efficient and makes your battery last longer than compared to a standard blade.

<p><b>Strong and least chipping</b></p> <p>Special blade tip design greatly improves efficiency and durability.</p>	<p><b>Release swarf smoothly</b></p>	<p><b>Superior in straight cutting</b></p> <p>The load on blade tips can be distributed efficiently to suppress wobbling of saw blade, providing steady straight cutting and increased durability against tip breakage.</p>
<p><b>MORE CUTS PER CHARGE</b></p>	<p><b>FAST CUTTING</b></p>	<p><b>LONGER LIFE</b></p>

Blade Dia (mm)	Suitable for Models	(Bore) Hole dia. (mm)	(Kerf) Tip Thickness (mm)	Plate (mm)	Hook Angle (deg)	No. of teeth	Tooth shape	Material	Part No.
150	DCS553	20	1.1	0.95	0	33	SMTCG	Metal	B-69440
150	DCS553	20	1.1	0.95	0	48	SMTCG	Metal & SUS	B-69456
185	CS002G	20	1.4	1.2	0	45	SMTCG	Metal	E-12918
185	CS002G	20	1.4	1.2	0	60	SMTCG	Metal & SUS	E-12924

### Specialized Saw Blade for Metal Cutter

Blade Dia (mm)	Suitable for Models	(Bore) Hole dia. (mm)	(Kerf) Tip Thickness (mm)	Hook Angle (deg)	No. of teeth	Tooth Shape	Material / Application	Type	Part No.
136	DCS550	20	1.5	0	30	MTCG	Mild steel	-	B-07319
150	DCS553	20	1.5	0	32	MTCG	Mild steel (1-3mm)	-	B-46296
150	DCS553	20	1.1	0	60	SMTCG	Stainless/Mild steel (1-3mm)	Laser Slit	B-47014
150	DCS553	20	1.1	0	32	TCG	Thick metal (3mm to 12mm)	Laser Slit	■ E-02923
185	CS002G, 4131	20	1.9	0	36	ATB	Mild steel (2 - 6mm)	A	B-04628
185	CS002G, 4131	20	2.0	0	48	MTCG	Thin mild steel (2 - 4mm)	-	A-83967
185	CS002G, 4131	20	1.7	-10	70	FTG	Corrugated thin plate (Less than 2mm)	-	A-86446

A: Cermet tip type (Ceramic / Metal), Long Life

- DRILLING / FIXING
- CONCRETE DRILLING / DEMOLITION
- MIXING / STIRRING
- CUTTING (CONCRETE / METAL)
- GRINDING
- SANDING / POLISHING
- SAWING
- MULTI-TOOL
- ROUTERS / PLANERS
- NAILERS / STAPLERS
- HEAT GUN / LASER
- CLEANING
- OPE
- JOBSITE TOOLS
- SPECIALTY TOOLS
- HAND TOOLS / COMBINATION SET
- TOOL HOLDERS AND POUCHES / MAKPAC SYSTEM

### Metal Cutting Saw Blades Cutting Tips

**\* Secure the workpiece to a stable platform**

When cutting a long workpiece, always use support to minimize the risk of blade pinching and kickback. It is important to support the workpiece properly to minimize the risk of injury and damage to the teeth of the saw blade.

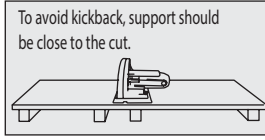
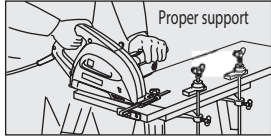

**\* Always use metal cutting saw blades appropriate for your job**

The use of inappropriate saw blades may cause a poor cutting performance and present a risk of personal injury.

**\* Adjust the cutting depth to the thickness of the workpiece**

Less than a full tooth of the blade should be exposed below workpiece.

**\* The base should be placed on the workpiece flat and firmly**  
No plunge cutting.

**\* Keep your cutting line straight and your speed constant**

Too slow cutting result in premature blade worn-out. Never twist nor force the tool while cutting.



**Caution!** Always wear safety glasses, gloves, protective equipment and follow instructions provided with power tool. Do not touch blade or workpiece immediately after cut.

### Metal Cutting Saw (LC1230) Accessories

#### Efficut saw blade for Metal Cutting Saw



Blade Dia (mm)	Suitable for Models	(Bore) Hole dia. (mm)	(Kerf) Tip Thickness (mm)	Plate (mm)	Hook Angle (deg)	No. of teeth	Tooth shape	Material	Part No.
305	LC1230	25.4	2.0	1.75	-2	63	SMTCG	Metal	E-12083
305	LC1230	25.4	2.0	1.75	-3	96	SMTCG	Metal, SUS	E-19788

#### Specialized blade for Metal Cutting Saw

Blade Dia (mm)	Suitable for Models	(Bore) Hole dia. (mm)	(Kerf) Tip Thickness (mm)	Hook Angle (deg)	No. of teeth	Tooth Shape	Material / Application	Type	Part No.
305	LC1230	25.4	2.4	0	60	TCG	For cutting mild steel	Laser slit	A-86723
305	LC1230	25.4	2.4	0	78	MTCG	For thinner mild steel	-	A-87127
305	LC1230	25.4	2.3	0	76	-	For stainless steel	-	A-87579
305	LC1230	25.4	2.1	0	60	TCG	For mild steel	-	A-87242

### Grooving Saw Blade (Aluminium Composite) for CA5000XJ

#### Specialized Blade for Aluminium composite

CA5000XJ (AC)



Blade Dia (mm)	Suitable for Models	(Bore) Hole dia. (mm)	Plate (mm)	(Kerf) Tip Thickness (mm)	Hook Angle (deg)	No. of teeth	Tooth Shape	Part No.
118	CA5000XJ	20	6	14	5	6	90°	B-48832
118	CA5000XJ	20	6	18	5	6	135°	B-48860

## Portable Band Saw Accessories

### Portable Band Saw Blades

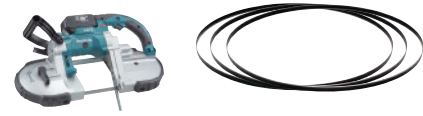

For Model : PB002G / DPB180 / 2106/ 2106W / 2107FK

Blade type	WX L (mm)	Thickness (mm)	Thickness of work piece	Teeth Per Inch (TPI)	Application	Pcs per package	Part No.
Carbon steel	1140 x 13mm	0.5	-	6	Wood	3	792567-9
Carbon steel	1140 x 13mm	0.5	More than 5mm	14	Plastics and non ferrous metals. Mild steel, cast steel and cast iron	3	792560-3
Carbon steel	1140 x 13mm	0.5	4 - 5mm	18		3	792559-8
Carbon steel	1140 x 13mm	0.5	Less than 4mm	24		3	792558-0
Bi-Metal	1140 x 13mm	0.5	More than 5.5mm	10		1	B-30128
Bi-Metal	1140 x 13mm	0.5	More than 5mm	14	Plastics and non ferrous metals. Mild steel, cast steel and cast iron. Hard steel and stainless steel	1	792557-2
Bi-Metal	1140 x 13mm	0.5	4 - 5mm	18		1	792556-4
Bi-Metal	1140 x 13mm	0.5	Less than 4mm	24		1	194692-6
				WAVE TEETH			

For Model: DPB181 / DPB182 / DPB183

Blade type	WX L (mm)	Thickness (mm)	Thickness of work piece	Teeth Per Inch (TPI)	Application	Pcs per package	Part No.
Bi-Metal	835 x 13mm	0.5	3mm-6 mm	14 WAVE TEETH	Plastics and non-ferrous metal. Mild steel, cast steel and cast iron. Hard steel and stainless steel.	5	B-40543
Bi-Metal	835 x 13mm	0.5	2 mm- 3 mm	18 WAVE TEETH		5	B-40559
Bi-Metal	835 x 13mm	0.5	less than 2mm	24 WAVE TEETH		5	B-40565

### Portable Band Saw Stand / Cover and Wax

For accurate square cutting operations

Blade type	Width x Length (mm)	Part No.
2106	Portable band saw stand	STEX122370
2107FK	Portable band saw stand	194026-3
2107FK	Cover	194070-0
2107FK	Portable band saw stand & Cover set	194069-5
DPB181	Cover	197975-3
Cutting Wax For Portable Band Saw		191897-9



## Portable Cut-Off Accessories

### Abrasive cut-off wheel (for Portable Cut-off)

- 3mm thickness
- For all ferrous materials - Steel, Cast iron and other hard metals



Size (mm)	Grit	Pc Per Pkg	Max. RPM	Part No.
355 x 3.0 x 25.4	A36T	25	3,900	E-10540-25 (Economy Range)
305 x 3.0 x 25.4	A36P	25	4,500	A-87650-25
355 x 3.0 x 25.4	A36P	25	3,900	A-87672-25
405 x 3.0 x 25.4	A36P	25	3,380	A-87694-25

DRILLING  
/ FIXING

CONCRETE  
DRILLING /  
DEMOLITION

MIXING /  
STIRRING

CUTTING  
(CONCRETE /  
METAL)

GRINDING

SANDING /  
POLISHING

SAWING

MULTI-TOOL

ROUTERS /  
PLANERS

NAILERS /  
STAPLERS

HEAT GUN /  
LASER

CLEANING

OPE

JBSITE  
TOOLS

SPECIALTY  
TOOLS

HAND TOOLS /  
COMBINATION SET

TOOL HOLDERS  
AND POUCHES /  
MAKPAC SYSTEM

# Threaded Rod Cutters / Steel Rod Cutter Blades and Accessories

## Cutter blade and saw blade



Cutter blade

For Model	Type	Size	Part no:
DSC121	Mild Steel - Stainless Steel	M12	<b>SC09002720</b>
DSC121	Mild Steel - Stainless Steel	M10	<b>SC09002710</b>
DSC121	Mild Steel - Stainless Steel	M8	<b>SC09002700</b>



Cutter blade

For Model	Type	Size	Part no:
DSC102	Mild Steel - Stainless Steel	M6	<b>199082-8</b>
DSC102	Mild Steel - Stainless Steel	M8	<b>199085-2</b>
DSC102	Mild Steel	M10	<b>199083-6</b>



Cutter blade

For Model	Type	Part no:
DCS163	Cutter blade set	<b>SC09002470</b>



Saw blade

For Model	Type	Size	Part no:
DSC251	EFFICUT TCT Saw Blade	110mm	<b>E-11097</b>

## Hole Puncher accessories

### Combination of punch and die

Punching holes through a thin structural metal plate may cause deformation of the plate and burr on the holes. If you need precision punching, see the tables below to select an optimum combination of punch and die.

Round punching

Oblong punching



● Round punching							
Punch		Die		Cutting material			
				Tensile		Channel	Tensile
				Mild Steel (65,000 psi)			Stainless Steel (89,000 psi)
Hole diameter (mm)	Part No.	Hole diameter (mm)	Part No.	Thickness			
6	SC05340040	SB6	SC00000203	t2-t4		t3-t4	
6.5	SC05340050	SB6.5	SC00000205	t2-t6		t3-t4	
8	SC05340060	SB8	SC00000207	t2-t6		t3-t4	
8.5	SC05340070	SB8.5	SC00000209	t2-t6		t3-t4	
10	SC05340080	SB10	SC00000211	t2-t6	t7.5	t3-t4	
11	SC05340090	SB11	SC00000213	t2-t8	t7.5	t3-t6	
12	SC05340100	SB12	SC00000215	t2-t8	t7.5	t3-t6	
13	SC05340110	SB13	SC00000217	t2-t8	t7.5	t3-t6	
14	SC05340120	SB14	SC00000219	t2-t8	t7.5	t3-t6	
15	SC05340130	SB15	SC00000221	t2-t8	t7.5	t3-t6	
16	SC05340140	SB16	SC05332710	t2-t8	t7.5	t3-t6	
18	SC05340150	SB18	SC00000223	t2-t8	t7.5	t3-t6	
20	SC05340160	SB20	SC05352510	t2-t8	t7.5	t3-t6	

● Oblong punching							
Punch		Die		Cutting material			
				Tensile		Channel	Tensile
				Mild Steel (65,000 psi)			Stainless Steel (89,000 psi)
Hole diameter (mm)	Part No.	Hole diameter (mm)	Part No.	Thickness			
6.5 x 10	SC05340200	6.5 x 10B	SC00000244	t2-t6		t3-t4	
6.5 x 13	SC05340210	6.5 x 13B	SC00000246	t2-t6		t3-t4	
8.5 x 13	SC05340220	8.5 x 13B	SC00000248	t2-t6		t3-t4	
8.5 x 17	SC05340230	8.5 x 17B	SC00000250	t2-t6		t3-t4	
9 x 13.5	SC05340240	9 x 13.5B	SC00000252	t2-t6		t3-t4	
9 x 18	SC05340250	9 x 18B	SC00000254	t2-t6		t3-t4	
10 x 15	SC05340260	10 x 15B	SC00000256	t2-t8	t7.5	t3-t6	
10 x 20	SC05340270	10 x 20B	SC00000258	t2-t8	t7.5	t3-t6	
11 x 16.5	SC05340280	11 x 16.5B	SC00000260	t2-t8	t7.5	t3-t6	
12 x 18	SC05340290	12 x 18B	SC00000262	t2-t8	t7.5	t3-t6	
13 x 19.5	SC05340300	13 x 19.5B	SC00000264	t2-t8	t7.5	t3-t6	
14 x 21	SC05340310	14 x 21B	SC00000266	t2-t8	t7.5	t3-t6	

DRILLING / FIXING

CONCRETE DRILLING / DEMOLITION

MIXING / STIRRING

CUTTING (CONCRETE / METAL)

GRINDING

SANDING / POLISHING

SAWING

MULTI-TOOL

ROUTERS / PLANERS

NAILERS / STAPLERS

HEAT GUN / LASER

CLEANING

OPE

JOBSITE TOOLS

SPECIALTY TOOLS

HAND TOOLS / COMBINATION SET

TOOL HOLDERS AND POUCHES / MAKAPAC SYSTEM



## Stand

- Used with Hole Puncher



**Work stand**  
Allows the tool to be stationed over a flat surface



**Slide stopper**  
Allows the workpiece to be positioned up to 40mm from the edge

For model	Type	Part No.
DPP200	A	SC03801080
DPP200	B	SC03300790

## Oil

- Used with Threaded Rod Cutters / Hole Puncher



For model	Size	Type	Part No.
DSC 163, DPP200	35mL	A	SC00000106
DSC 163, DPP200	1,000mL	B	SC00000270

## Shear and Nibbler accessories

### Shear accessories

#### Shear Head Assembly

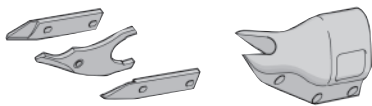

For Model	Part No
JS1300	125112-9

#### Shear Blade Set

Two per set in blister pack

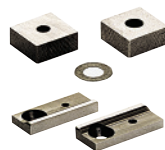

For Model	Part No
JS1600, JS1602	191383-0
JS1660, JS1601, DJS101	792533-6
JS3200, JS3201	792287-5

#### Side Blade

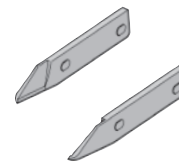

JS1300 (R)	792742-7
JS1300 (L)	792743-5
DJS131 (R)	725256-1
DJS131 (L)	725258-7
DJS200 (R)	725092-5
DJS200 (L)	725093-3
DJS800	725130-3

#### Center Blade



For Model	Part No
JS1300	792744-3
JS1660, JS1601, DJS101	792534-4
DJS131	725257-9
DJS200	725255-3
DJS800	725129-8

#### Thickness Gage



To set blades at the proper gap

For Model	Part No
JS3200, JS3201	762007-1
JS1660, JS1601	762013-6

DRILLING / FIXING

CONCRETE DRILLING / DEMOLITION

MIXING / STIRRING

CUTTING (CONCRETE / METAL)

GRINDING

SANDING / POLISHING

SAWING

MULTI-TOOL

ROUTERS / PLANERS

NAILERS / STAPLERS

HEAT GUN / LASER

CLEANING

OPE

JOB SITE TOOLS

SPECIALTY TOOLS

HAND TOOLS / COMBINATION SET

TOOL HOLDERS AND POUCHES / MAKPAC SYSTEM

- DRILLING / FIXING
- CONCRETE DRILLING / DEMOLITION
- MIXING / STIRRING
- CUTTING (CONCRETE / METAL)**
- GRINDING
- SANDING / POLISHING
- SAWING
- MULTI-TOOL
- ROUTERS / PLANERS
- NAILERS / STAPLERS
- HEAT GUN / LASER
- CLEANING
- OPE
- JOBSITE TOOLS
- SPECIALTY TOOLS
- HAND TOOLS / COMBINATION SET
- TOOL HOLDERS AND POUCHES / MAKPAC SYSTEM

### Nibbler Accessories

#### Punch

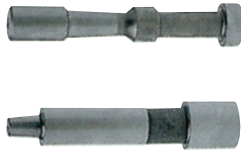

#### Die

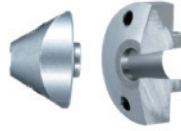

#### Washer

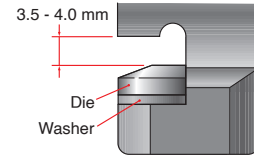

To keep clearance of 3.5 to 4.0mm, use a washer or two under the die when installing a resharpened die.

For Model	Part No	For Model	Part No
JN1601, DJN161	A-83951	JN101, DJN161	A-15051
JN3200, JN3201	792728-1	JN3200, JN3201	792292-2

For Model	Part No
JN3200, JN3201	341796-7

#### Wrench



#### Hex Wrench



For Model	Part No	For Model	Size	Part No
JN3200, JN3201	781019-5	JN3200, JN3201, JS1660, JS1601, JS1602	3.0mm	783201-2
		JN1601	2.5mm	783208-8

### Tile Cutter and Metal Cutter Accessories

#### Wear supply pipe for Cutter



For Model	Part No.
DCC501	191M48-2
4100NH	164405-9
4140	153555-5

#### Vinyl tube (Water supply hose) for Cutter



For Model	Size(mm)	Part No.
DCC501	-	140Y23-7
4100NH, 4101RH, 4140	5 x 7 x 5,000	412010-9

### Dust Cover and Dust bag assembly

For Dustless cutter



Suitable for		Part No.
DCC501	Dust Cover Set (including dust bag)	191N83-6
DCC501	Dust bag	126738-0
4105KB	Dust bag	123185-6
DMC300	Dust Cover Set	■ 122C54-6

DRILLING  
/ FIXING

CONCRETE  
DRILLING /  
DEMOLITION

MIXING /  
STIRRING

CUTTING  
(CONCRETE /  
METAL)

GRINDING

SANDING /  
POLISHING

SAWING

MULTI-TOOL

ROUTERS /  
PLANERS

NAILERS /  
STAPLERS

HEAT GUN /  
LASER

CLEANING

OPE

JOBSITE  
TOOLS

SPECIALTY  
TOOLS

HAND TOOLS /  
COMBINATION SET

TOOL HOLDERS  
AND POUCHES /  
MAKPAC SYSTEM

### Base cover set

Protects drywall surfaces from damage / scratches



For Model	Part No.
DCC501	196943-3

### Parallel guide, rip fence

4101RH (Use with 924206-5 Wing bolt M5 X 10)  
4131 (Use with 265701-9 Wing bolt M6 X 14)



For Model	Part No.
4191D, 4100NH, 4101RH, 4131, CS002G	164095-8

### Guide Rail adapter



For Model	Part No.
DCC501	198673-2

guide rail adapter required when using with 1.4m Guide Rail 194368-5 and 3m 194367-7 Guide rail

## Wrenches

### Wrench / Socket / Hex Wrench

- Used with Cutters / Portable cutt-off, Wall chaser, Hole puncher, Rod cutter

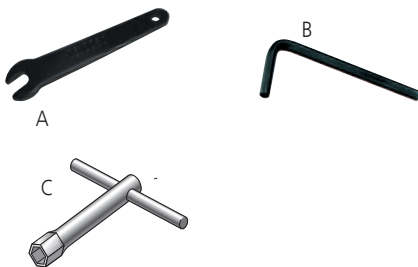

For model	Size	Type	Part No.
4105KB, 4140 / 4100NH	22	A	■ 781041-2
4100NH, 4100NB, 4140, 9308	9	B	782209-3
2414 / 2414B / 2414NB / 2416S / 4131 / LC1230	17	B	782210-8
SG1250 / SG1251	6	C	783204-6
4131, CS002G	-	B	783203-8

# Grinding

Angle grinders, Die Grinders,  
Bench Grinders, Straight Grinders  
Concrete Planers



## FEATURES

### High durability with BL motor (cordless)

- Large ball bearing supports the motor.
- New switch design to reduce contact weariness

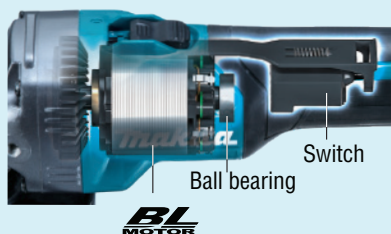

### Tool-less wheel cover

- Allows for fast and easy angle adjustment and installation / removal of wheel cover

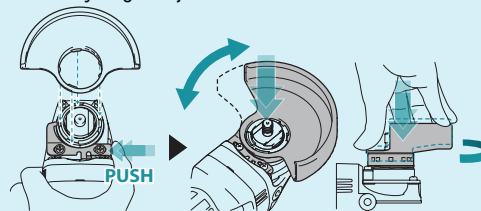

### Electric brake

Enables you to start next operation quickly

### Soft Start

Minimizes start-up shock, and makes the tool start smoothly

### Anti-restart function

Prevents accidental start-up

### Variable Speed

Variable speed control dial (8,500 - 3,000 RPM)  
Matches the speed to your application

	No load speed (RPM)	Cutting / Rough grinding	Grinding / Finish grinding	Rust removal / Paint removal	Stainless steel polishing
1	3,000				✓
2	4,500			✓	✓
3	6,000		✓	✓	✓
4	7,500		✓		
5	8,500	✓			

### Auto-start Wireless System (cordless)

**AWS** Connects to compatible Dust Extractor with Bluetooth. Dust extractor starts automatically when the tool starts. Also dust extractor stops on its own when the tool is in rest



Bluetooth



Bluetooth Chip (Optional)  
Part #: 198900-7

### ADT

**Automatic torque Drive Technology** automatically changes the cutting speed according to load conditions for an optimum operation

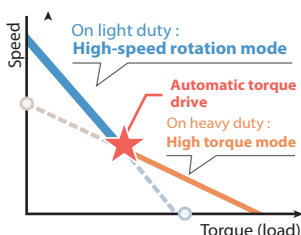

### AFT

**Active Feedback sensing Technology** Shuts down the tool, if the rotation speed suddenly slows down.

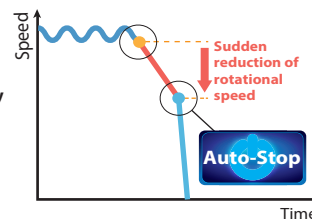

SLIDE Switch Type



PADDLE Switch Type

DRILLING / FIXING

CONCRETE DRILLING / DEMOLITION

MIXING / STIRRING

CUTTING (CONCRETE / METAL)

GRINDING

SANDING / POLISHING

SAWING

MULTI-TOOL

ROUTERS / PLANERS

NAILERS / STAPLERS

HEAT GUN / LASER

CLEANING

OPE

JOB SITE TOOLS

SPECIALTY TOOLS

HAND TOOLS / COMBINATION SET

TOOL HOLDERS AND POUCHES / MAKPAC SYSTEM

# X-LOCK Angle Grinders

X-LOCK Angle Grinders offer an innovative accessory quick-change system. X-LOCK is a locking mechanism that makes tool-less accessory changes up to 5-times faster than traditional threaded locknut mounting, so you can get back to cutting, grinding, or prepping faster



Simply press to place



Pull the lever to release



GA040G 115mm

40V MAX | XGT

Cordless Angle Grinder (AWS)



VARIABLE SPEED



SLIDE SWITCH

### Excellent in continuous heavy-duty work Slide Switch X-lock Angle Grinders with AWS function

- High durability with BL motor
- New tool-less wheel cover
- AFT - Shuts down the tool, if the rotation speed suddenly slows down
- Equipped with Anti-restart function, Electric brake and Soft start
- Variable speed control dial matches the speed to your application.



Wheel Diameter	115 mm
Hole Diameter	22.23 mm
No Load Speed (RPM)	3,000 - 8,500
Sound Pressure Level	81 dB(A)
Sound Power Level	92 dB(A)
Dimensions (L x W x H)	433 x 130 x 168 mm
Net weight	3.6 kg

Standard Equipment: Toolless Wheel Cover, Side Handle, Lock Nut Wrench

AVAILABLE VARIANTS

4.0Ah	"Z" VARIANT
<b>GA040G M2</b> INCLUDES 2 BATTERIES / 1 CHARGER / MAKPAC CONNECTOR CASE (DOES NOT INCLUDE BLUETOOTH CHIP)	<b>GA040G Z</b> TOOL ONLY (DOES NOT INCLUDE BATTERY / CHARGER / BLUETOOTH CHIP / CARRYING CASE)

GA041G 125mm

40V MAX | XGT

Cordless Angle Grinder (AWS)



VARIABLE SPEED

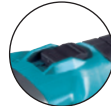

SLIDE SWITCH

### Excellent in continuous heavy-duty work Slide Switch X-lock Angle Grinders with AWS function

- High durability with BL motor
- New tool-less wheel cover
- AFT - Shuts down the tool, if the rotation speed suddenly slows down
- Equipped with Anti-restart function, Electric brake and Soft start
- Variable speed control dial matches the speed to your application.



Wheel Diameter	125 mm
Hole Diameter	22.23 mm
No Load Speed (RPM)	3,000 - 8,500
Sound Pressure Level	81 dB(A)
Sound Power Level	92 dB(A)
Dimensions (L x W x H)	433 x 140 x 168 mm
Net weight	3.6 kg

Standard Equipment: Toolless Wheel Cover, Side Handle, Lock Nut Wrench

AVAILABLE VARIANTS

4.0Ah	"Z" VARIANT
<b>GA041G M2</b> INCLUDES 2 BATTERIES / 1 CHARGER / MAKPAC CONNECTOR CASE (DOES NOT INCLUDE BLUETOOTH CHIP)	<b>GA041G Z</b> TOOL ONLY (DOES NOT INCLUDE BATTERY / CHARGER / BLUETOOTH CHIP / CARRYING CASE)

GA046G 115mm

40V MAX | XGT

Cordless Angle Grinder



PADDLE SWITCH

### Excellent in continuous heavy-duty work Paddle Switch X-lock Angle Grinders

- High durability with BL motor
- New tool-less wheel cover
- AFT - Shuts down the tool, if the rotation speed suddenly slows down
- Equipped with Anti-restart function, Electric brake and Soft start



Wheel Diameter	115 mm
Hole Diameter	22.23 mm
No Load Speed (RPM)	8,500
Sound Pressure Level	81 dB(A)
Sound Power Level	92 dB(A)
Dimensions (L x W x H)	418 x 130 x 168 mm
Net weight	3.6kg



Standard Equipment: Toolless Wheel Cover, Side Handle, Lock Nut Wrench

AVAILABLE VARIANTS

4.0Ah	"Z" VARIANT
<b>GA046G M2</b> INCLUDES 2 BATTERIES / 1 CHARGER / MAKPAC CONNECTOR CASE (DOES NOT INCLUDE BLUETOOTH CHIP)	<b>GA046G Z</b> TOOL ONLY (DOES NOT INCLUDE BATTERY / CHARGER / BLUETOOTH CHIP / CARRYING CASE)

**GA047G** 125mm **40V MAX | XGT**

**Cordless Angle Grinder**

**PADDLE SWITCH**

**Excellent in continuous heavy-duty work Paddle Switch X-lock Angle Grinders**

- High durability with BL motor
- New tool-less wheel cover
- AFT - Shuts down the tool, if the rotation speed suddenly slows down
- Equipped with Anti-restart function, Electric brake and Soft start

**40V MAX BL AFT XPT XLOCK**

Wheel Diameter	125 mm
Hole Diameter	22.23 mm
No Load Speed (RPM)	8,500
Sound Pressure Level	82 dB(A)
Sound Power Level	93 dB(A)
Dimensions (L x W x H)	418 x 140 x 168 mm
Net weight	3.6 kg



**Standard Equipment:** Toolless Wheel Cover, Side Handle, Lock Nut Wrench

**AVAILABLE VARIANTS**

4.0Ah	"Z" VARIANT
<b>GA047G M2</b> INCLUDES 2 BATTERIES / 1 CHARGER / MAKPAC CONNECTOR CASE (DOES NOT INCLUDE BLUETOOTH CHIP)	<b>GA047G Z</b> TOOL ONLY (DOES NOT INCLUDE BATTERY / CHARGER / BLUETOOTH CHIP / CARRYING CASE)

**DGA519** 125mm **18V | LXT**

**Cordless Angle Grinder**

**PADDLE SWITCH**

**Safe and Quick fix in One Click with X-Lock system**

- High Power with Brushless motor and Variable speed for the most demanding applications
- Paddle type on/off switch, Anti-restart function and Electric Brake.
- New tool-less wheel cover (Slide lever style for fast and easy angle adjustment and installation / removal of wheel cover)

**18V LXT BL AFT XPT XLOCK**

Wheel Diameter	125 mm (5")
Hole Diameter	22.23 mm
No Load Speed (RPM)	3,000 - 8,500
Circumference of Grip Portion	160 mm
Vibration Level	Surface Grinding w/ Anti-Vibration Side Grip: 7.0 m/s <sup>2</sup>
Sound Pressure Level	80 dB(A)
Dimensions (L x W x H)	396x140x147 mm
Net weight	3.1 kg



**Standard Equipment:** Lock nut wrench, Side grip.

**AVAILABLE VARIANTS**

5.0Ah	3.0Ah	"Z" VARIANT
		<b>DGA519 Z</b> TOOL ONLY (DOES NOT INCLUDE BATTERY / CHARGER OR CARRY CASE)

**DGA469** 115mm **18V | LXT**

**Cordless Angle Grinder**

**VARIABLE SPEED**



**PADDLE SWITCH**

**Safe and Quick fix in One Click with X-Lock system**

- High Power with Brushless motor and Variable speed for the most demanding applications
- Paddle type on/off switch, Anti-restart function and Electric Brake.
- New tool-less wheel cover (Slide lever style for fast and easy angle adjustment and installation / removal of wheel cover)

**18V LXT BL AFT XPT XLOCK**

Wheel Diameter	115 mm (4-1/2")
Hole Diameter	22.23 mm
No Load Speed (RPM)	3,000 - 8,500
Circumference of Grip Portion	160 mm
Vibration Level	Surface Grinding w/ Anti-Vibration Side Grip: 5.5 m/s <sup>2</sup>
Sound Pressure Level	80 dB(A)
Dimensions (L x W x H)	396x130x147 mm
Net weight	3.1 kg

**Standard Equipment:** Lock nut wrench, Side grip.

**AVAILABLE VARIANTS**

5.0Ah	3.0Ah	"Z" VARIANT
		<b>DGA469 Z</b> TOOL ONLY (DOES NOT INCLUDE BATTERY / CHARGER OR CARRY CASE)

**GA5080R** 125mm **AC**

**Angle Grinder**



**SLIDE SWITCH**

**Safe and Quick fix in One Click with X-Lock system**

- SJS technology is a mechanical clutch system that helps prevent motor and gear damage
- Anti-restart function.
- Tool-less wheel cover: for fast and easy adjustment / installation and removal
- Ergonomically best possible barrel grip.
- Electronic current limiter helps protect the motor from overload

**SJS SUPER JOINT SYSTEM XLOCK**

Continuous rating Input	1,400W
Wheel Diameter	125 mm (5")
Hole Diameter	22.3 mm
Max Cutting Depth	31 mm
No Load Speed (RPM)	12,000
Circumference of Grip Portion	205 mm
Dimensions (L x W x H)	309 x 141 x 113 mm
Net weight	2.5 - 3.6 kg
Power supply cord	2.5 m

**Standard Equipment:** Side grip.

- DRILLING / FIXING
- CONCRETE DRILLING / DEMOLITION
- MIXING / STIRRING
- CUTTING (CONCRETE / METAL)
- GRINDING
- SANDING / POLISHING
- SAWING
- MULTI-TOOL
- ROUTERS / PLANERS
- NAILERS / STAPLERS
- HEAT GUN / LASER
- CLEANING
- OPE
- JBSITE TOOLS
- SPECIALTY TOOLS
- HAND TOOLS / COMBINATION SET
- TOOL HOLDERS AND POUCHES / MAKPAC SYSTEM

## XGT Grinders - Product Comparison List

	Model / Size					(rpm)	Switch	BL motor	AFT	Brake	XPT	Anti-restart function	Variable Speed
	115mm	125mm	150mm	180mm	230mm								
DRILLING / FIXING	GA004G	GA005G	GA035G			8,500	Slide	●	●	●	●	●	
CONCRETE DRILLING / DEMOLITION	GA012G	GA013G	GA036G			8,500	Paddle	●	●	●	●	●	
MIXING / STIRRING	GA049G	GA050G				11,000	Paddle	●	●	●	●	●	
CUTTING (CONCRETE / METAL)	GA022G	GA023G				3,000 - 8,500	Slide	●	●	●	●	●	●
	GA028G	GA029G				3,000 - 8,500	Paddle	●	●	●	●	●	●
				GA037G		7,800	Trigger	●	●	●	●	●	
					GA038G	6,600	Trigger	●	●	●	●	●	
GRINDING	GA040G	GA041G				3,000 - 8,500	Slide	●	●	●	●	●	●
	GA046G	GA047G				8,500	Paddle	●	●	●	●	●	



**GA004G** 115mm
40V MAX |

**Cordless Angle Grinder**

SLIDE SWITCH

**Excellent in continuous heavy-duty work Slide Switch Angle Grinders**

- High durability with BL motor
- New tool-less wheel cover
- AFT - Shuts down the tool, if the rotation speed suddenly slows down
- Equipped with Anti-restart function, Electric brake and Soft start

Wheel Diameter	115 mm
Hole Diameter	22.23 mm
No Load Speed (RPM)	8,500
Sound Pressure Level	81 dB(A)
Sound Power Level	92 dB(A)
Dimensions (L x W x H)	410x130x168 mm
Net weight	3.5 kg

**Standard Equipment:** Toolless Wheel Cover, Side Handle, Lock Nut Wrench

AVAILABLE VARIANTS

4.0Ah	"Z" VARIANT
<b>GA004G M2</b> INCLUDES 2 BATTERIES / 1 CHARGER / MAKPAC CONNECTOR CASE	<b>GA004G Z</b> TOOL ONLY (DOES NOT INCLUDE BATTERY / CHARGER / CARRYING CASE)

**GA005G** 125mm
40V MAX |

**Cordless Angle Grinder**

SLIDE SWITCH

**Excellent in continuous heavy-duty work Slide Switch Angle Grinders**

- High durability with BL motor
- New tool-less wheel cover
- AFT - Shuts down the tool, if the rotation speed suddenly slows down
- Equipped with Anti-restart function, Electric brake and Soft start

Wheel Diameter	125 mm
Hole Diameter	22.23 mm
No Load Speed (RPM)	8,500
Sound Pressure Level	81 dB(A)
Sound Power Level	92 dB(A)
Dimensions (L x W x H)	410x140x168 mm
Net weight	3.6 kg

**Standard Equipment:** Toolless Wheel Cover, Side Handle, Lock Nut Wrench

AVAILABLE VARIANTS

4.0Ah	"Z" VARIANT
<b>GA005G M2</b> INCLUDES 2 BATTERIES / 1 CHARGER / MAKPAC CONNECTOR CASE	<b>GA005G Z</b> TOOL ONLY (DOES NOT INCLUDE BATTERY / CHARGER / CARRYING CASE)



**GA012G** 115mm **40V MAX | XGT**

**Cordless Angle Grinder**



**PADDLE SWITCH**

**Excellent in continuous heavy-duty work Paddle Switch Angle Grinders**

- High durability with BL motor
- New tool-less wheel cover
- AFT - Shuts down the tool, if the rotation speed suddenly slows down
- Equipped with Anti-restart function, Electric brake and Soft start



Wheel Diameter	115 mm
Hole Diameter	22.23 mm
No Load Speed (RPM)	8,500
Sound Pressure Level	81 dB(A)
Sound Power Level	92 dB(A)
Dimensions (L x W x H)	410x130x168 mm
Net weight	3.5 kg

**Standard Equipment:** Toolless Wheel Cover, Side Handle, Lock Nut Wrench

AVAILABLE VARIANTS	
4.0Ah	"Z" VARIANT
<b>GA012G M2</b> INCLUDES 2 BATTERIES / 1 CHARGER / MAKPAC CONNECTOR CASE	<b>GA012G Z</b> TOOL ONLY (DOES NOT INCLUDE BATTERY / CHARGER / CARRYING CASE)

**GA013G** 125mm **40V MAX | XGT**

**Cordless Angle Grinder**



**PADDLE SWITCH**

**Excellent in continuous heavy-duty work Paddle Switch Angle Grinders**

- High durability with BL motor
- New tool-less wheel cover
- AFT - Shuts down the tool, if the rotation speed suddenly slows down
- Equipped with Anti-restart function, Electric brake and Soft start





Wheel Diameter	125 mm
Hole Diameter	22.23 mm
No Load Speed (RPM)	8,500
Sound Pressure Level	81 dB(A)
Sound Power Level	92 dB(A)
Dimensions (L x W x H)	410x140x168 mm
Net weight	3.6 kg

**Standard Equipment:** Toolless Wheel Cover, Side Handle, Lock Nut Wrench

AVAILABLE VARIANTS	
4.0Ah	"Z" VARIANT
<b>GA013G M2</b> INCLUDES 2 BATTERIES / 1 CHARGER / MAKPAC CONNECTOR CASE	<b>GA013G Z</b> TOOL ONLY (DOES NOT INCLUDE BATTERY / CHARGER / CARRYING CASE)

**GA022G** 115mm **40V MAX | XGT**

**Cordless Angle Grinder (AWS)**

**VARIABLE SPEED**  
**SLIDE SWITCH**

**Excellent in continuous heavy-duty work Slide Switch Angle Grinders with AWS function**

- High durability with BL motor
- New tool-less wheel cover
- AFT - Shuts down the tool, if the rotation speed suddenly slows down
- Equipped with Anti-restart function, Electric brake and Soft start
- Variable speed control dial matches the speed to your application.



Wheel Diameter	115 mm
Hole Diameter	22.23 mm
No Load Speed (RPM)	3,000 - 8,500
Sound Pressure Level	81 dB(A)
Sound Power Level	92 dB(A)
Dimensions (L x W x H)	425x130x168 mm
Net weight	3.6 kg

**Standard Equipment:** Toolless Wheel Cover, Side Handle, Lock Nut Wrench

AVAILABLE VARIANTS	
4.0Ah	"Z" VARIANT
<b>GA022G M2</b> INCLUDES 2 BATTERIES / 1 CHARGER / MAKPAC CONNECTOR CASE (DOES NOT INCLUDE BLUETOOTH CHIP)	<b>GA022G Z</b> TOOL ONLY (DOES NOT INCLUDE BATTERY / CHARGER / BLUETOOTH CHIP / CARRYING CASE)

**GA023G** 125mm **40V MAX | XGT**

**Cordless Angle Grinder (AWS)**



**VARIABLE SPEED**  
**SLIDE SWITCH**

**Excellent in continuous heavy-duty work Slide Switch Angle Grinders with AWS function**

- High durability with BL motor
- New tool-less wheel cover
- AFT - Shuts down the tool, if the rotation speed suddenly slows down
- Equipped with Anti-restart function, Electric brake and Soft start
- Variable speed control dial matches the speed to your application.



Wheel Diameter	125 mm
Hole Diameter	22.23 mm
No Load Speed (RPM)	3,000 - 8,500
Sound Pressure Level	81 dB(A)
Sound Power Level	92 dB(A)
Dimensions (L x W x H)	425x140x168 mm
Net weight	3.6 kg

**Standard Equipment:** Toolless Wheel Cover, Side Handle, Lock Nut Wrench



AVAILABLE VARIANTS	
4.0Ah	"Z" VARIANT
<b>GA023G M2</b> INCLUDES 2 BATTERIES / 1 CHARGER / MAKPAC CONNECTOR CASE (DOES NOT INCLUDE BLUETOOTH CHIP)	<b>GA023G Z</b> TOOL ONLY (DOES NOT INCLUDE BATTERY / CHARGER / BLUETOOTH CHIP / CARRYING CASE)

- DRILLING / FIXING
- CONCRETE DRILLING / DEMOLITION
- MIXING / STIRRING
- CUTTING (CONCRETE / METAL)
- GRINDING
- SANDING / POLISHING
- SAWING
- MULTI-TOOL
- ROUTERS / PLANERS
- NAILERS / STAPLERS
- HEAT GUN / LASER
- CLEANING
- OPE
- JOB SITE TOOLS
- SPECIALTY TOOLS
- HAND TOOLS / COMBINATION SET
- TOOL HOLDERS AND POUCHES / MAKPAC SYSTEM

DRILLING / FIXING
CONCRETE DRILLING / DEMOLITION
MIXING / STIRRING
CUTTING (CONCRETE / METAL)
<b>GRINDING</b>
SANDING / POLISHING
SAWING
MULTI-TOOL

**GA028G** 115mm **40V MAX | XGT**

**Cordless Angle Grinder (AWS)**

VARIABLE SPEED



PADDLE SWITCH

**Excellent in continuous heavy-duty work Paddle Switch Angle Grinders with AWS function**

- High durability with BL motor
- New tool-less wheel cover
- AFT - Shuts down the tool, if the rotation speed suddenly slows down
- Equipped with Anti-restart function, Electric brake and Soft start
- Variable speed control dial matches the speed to your application.

Wheel Diameter	115 mm
Hole Diameter	22.23 mm
No Load Speed (RPM)	3,000 - 8,500
Sound Pressure Level	81 dB(A)
Sound Power Level	92 dB(A)
Dimensions (L x W x H)	425x130x168 mm
Net weight	3.6kg

**Standard Equipment:** Toolless Wheel Cover, Side Handle, Lock Nut Wrench

AVAILABLE VARIANTS	
4.0Ah	"Z" VARIANT
<b>GA028G M2</b> INCLUDES 2 BATTERIES / 1 CHARGER / MAKPAC CONNECTOR CASE (DOES NOT INCLUDE BLUETOOTH CHIP)	<b>GA028G Z</b> TOOL ONLY (DOES NOT INCLUDE BATTERY / CHARGER / BLUETOOTH CHIP / CARRYING CASE)

ROUTERS / PLANERS
NAILERS / STAPLERS
HEAT GUN / LASER
CLEANING
OPE
JOBSITE TOOLS
SPECIALTY TOOLS
HAND TOOLS / COMBINATION SET
TOOL HOLDERS AND POUCHES / MAKPAC SYSTEM

**GA049G** 115mm **40V MAX | XGT**

**Cordless Angle Grinder**



PADDLE SWITCH

**High power for heavy duty operation. Fast Cutting / Grinding**

- High durability with BL motor and new housing structure provides high rotation speed (11,000rpm) similar to that of corded models
- Anti-vibration construction
- New tool-less wheel cover
- AFT - Shuts down the tool, if the rotation speed suddenly slows down
- Equipped with Anti-restart function, Electric brake and Soft start



Wheel Diameter	115 mm (4-1/2")
No Load Speed (RPM)	11,000
Dimensions (L x W x H)	343 x 130 x 150 mm
Net weight	2.3 kg (without battery)

**Standard Equipment:** Toolless wheel cover, Side grip,

AVAILABLE VARIANTS	
5.0Ah	"Z" VARIANT
<b>GA049G T1</b> INCLUDES 1 BATTERY / 1 CHARGER / MAKPAC CONNECTOR CASE	<b>GA049G Z</b> TOOL ONLY (DOES NOT INCLUDE BATTERY / CHARGER / CARRYING CASE)

**GA029G** 125mm **40V MAX | XGT**

**Cordless Angle Grinder (AWS)**

VARIABLE SPEED



PADDLE SWITCH

**Excellent in continuous heavy-duty work Paddle Switch Angle Grinders with AWS function**

- High durability with BL motor
- New tool-less wheel cover
- AFT - Shuts down the tool, if the rotation speed suddenly slows down
- Equipped with Anti-restart function, Electric brake and Soft start
- Variable speed control dial matches the speed to your application.

Wheel Diameter	125 mm
Hole Diameter	22.23 mm
No Load Speed (RPM)	3,000 - 8,500
Sound Pressure Level	82 dB(A)
Sound Power Level	93 dB(A)
Dimensions (L x W x H)	425x140x168 mm
Net weight	3.6 kg

**Standard Equipment:** Toolless Wheel Cover, Side Handle, Lock Nut Wrench

AVAILABLE VARIANTS	
4.0Ah	"Z" VARIANT
<b>GA029G M2</b> INCLUDES 2 BATTERIES / 1 CHARGER / MAKPAC CONNECTOR CASE (DOES NOT INCLUDE BLUETOOTH CHIP)	<b>GA029G Z</b> TOOL ONLY (DOES NOT INCLUDE BATTERY / CHARGER / BLUETOOTH CHIP / CARRYING CASE)

**GA050G** 125mm **40V MAX | XGT**

**Cordless Angle Grinder**



PADDLE SWITCH

**High power for heavy duty operation. Fast Cutting / Grinding**

- High durability with BL motor and new housing structure provides high rotation speed (11,000rpm) similar to that of corded models
- Anti-vibration construction
- New tool-less wheel cover
- AFT - Shuts down the tool, if the rotation speed suddenly slows down
- Equipped with Anti-restart function, Electric brake and Soft start

Wheel Diameter	125 mm (5")
No Load Speed (RPM)	11,000
Dimensions (L x W x H)	343 x 140 x 150 mm
Net weight	2.3 kg (without battery)

**Standard Equipment:** Toolless wheel cover, Side grip,

AVAILABLE VARIANTS	
5.0Ah	"Z" VARIANT
<b>GA050G T1</b> INCLUDES 1 BATTERY / 1 CHARGER / MAKPAC CONNECTOR CASE	<b>GA050G Z</b> TOOL ONLY (DOES NOT INCLUDE BATTERY / CHARGER / CARRYING CASE)

**GA035G 150mm** 40V MAX | XGT

**Cordless Angle Grinder**



**SLIDE SWITCH**

**Excellent in continuous heavy-duty work Slide Switch Angle Grinders**

- High durability with BL motor
- New tool-less wheel cover
- AFT - Shuts down the tool, if the rotation speed suddenly slows down
- Equipped with Anti-restart function, Electric brake and Soft start

**40V MAX BL AFT XPT AWS**

Wheel Diameter	150 mm
No Load Speed (RPM)	8,500
Circumference of Grip Portion	146 mm
Vibration Level : Surface grinding / Disc Sanding	7.0 m/s <sup>2</sup> / 4.5 m/s <sup>2</sup>
Sound Pressure Level / Sound Power Level	82 dB(A) / 93 dB(A)
Dimensions (L x W x H) w/ BL4040	410 x 171 x 168 mm
Net weight	2.3 kg (without battery)

**Standard Equipment:** Toolless Wheel Cover, Side Handle, Lock Nut Wrench



**AVAILABLE VARIANTS**

**"Z" VARIANT**

**GA035G Z**  
TOOL ONLY  
(DOES NOT INCLUDE BATTERY / CHARGER / CARRYING CASE)

**GA036G 150mm** 40V MAX | XGT

**Cordless Angle Grinder**

**PADDLE SWITCH**

**Excellent in continuous heavy-duty work Paddle Switch Angle Grinders**

- High durability with BL motor
- New tool-less wheel cover
- AFT - Shuts down the tool, if the rotation speed suddenly slows down
- Equipped with Anti-restart function, Electric brake and Soft start

**40V MAX BL AFT XPT AWS**

Wheel Diameter	150 mm
No Load Speed (RPM)	8,500
Circumference of Grip Portion	151 mm
Vibration Level : Surface grinding / Disc Sanding	9.0 m/s <sup>2</sup> / 4.0 m/s <sup>2</sup>
Sound Pressure Level / Sound Power Level	82 dB(A) / 93 dB(A)
Dimensions (L x W x H) w/ BL4040	410 x 171 x 168 mm
Net weight	2.3 kg (without battery)

**Standard Equipment:** Toolless Wheel Cover, Side Handle, Lock Nut Wrench

**AVAILABLE VARIANTS**

**"Z" VARIANT**

**GA036G Z**  
TOOL ONLY  
(DOES NOT INCLUDE BATTERY / CHARGER / CARRYING CASE)

**GA037G 180mm** 40V MAX | XGT

**Cordless Angle Grinder**



**High power for heavy duty operation. Fast Cutting / Grinding.**

- High durability with BL motor
- New tool-less wheel cover
- AFT - Shuts down the tool, if the rotation speed suddenly slows down
- Equipped with Anti-restart function, Electric brake and Soft start
- Lightweight design achieved using one XGT battery

**40V MAX BL AFT XPT AWS**

Wheel Diameter	180 mm
No Load Speed (RPM)	7,800
Circumference of Grip Portion	154 mm
Vibration Level : Surface grinding	7.5 m/s <sup>2</sup>
Sound Pressure Level / Sound Power Level	88 dB(A) / 99 dB(A)
Dimensions (L x W x H) (without battery)	442 x 200 x 156
Net weight (without battery)	3.7 kg

**Standard Equipment:** Toolless Wheel Cover, Side Handle, Lock Nut Wrench

**AVAILABLE VARIANTS**

**"Z" VARIANT**

**GA037G Z**  
TOOL ONLY  
(DOES NOT INCLUDE BATTERY / CHARGER / BLUETOOTH CHIP, CARRYING CASE)

**GA038G 230mm** 40V MAX | XGT

**Cordless Angle Grinder**



**High power for heavy duty operation. Fast Cutting / Grinding.**

- High durability with BL motor
- New tool-less wheel cover
- AFT - Shuts down the tool, if the rotation speed suddenly slows down
- Equipped with Anti-restart function, Electric brake and Soft start
- Lightweight design achieved using one XGT battery

**40V MAX BL AFT XPT AWS**

Wheel Diameter	230 mm
No Load Speed (RPM)	6,600
Circumference of Grip Portion	154 mm
Vibration Level : Surface grinding	7.5 m/s <sup>2</sup>
Sound Pressure Level / Sound Power Level	87 dB(A) / 98 dB(A)
Dimensions (L x W x H) (without battery)	442 x 250 x 156
Net weight (without battery)	3.9 kg

**Standard Equipment:** Toolless Wheel Cover, Side Handle, Lock Nut Wrench

**AVAILABLE VARIANTS**

**"Z" VARIANT**

**GA038G Z**  
TOOL ONLY  
(DOES NOT INCLUDE BATTERY / CHARGER / BLUETOOTH CHIP, CARRYING CASE)

- DRILLING / FIXING
- CONCRETE DRILLING / DEMOLITION
- MIXING / STIRRING
- CUTTING (CONCRETE / METAL)
- GRINDING**
- SANDING / POLISHING
- SAWING
- MULTI-TOOL
- ROUTERS / PLANERS
- NAILERS / STAPLERS
- HEAT GUN / LASER
- CLEANING
- OPE
- JOBSITE TOOLS
- SPECIALTY TOOLS
- HAND TOOLS / COMBINATION SET
- TOOL HOLDERS AND POUCHES / MAKPAC SYSTEM

## LXT Grinders - Product Comparison List

	Model / Size					(rpm)	Switch	AWS	BL motor	AFT	Brake	XPT	Anti-start function	Variable Speed	XLOCK
	115mm	125mm	150mm	180mm	230mm										
CONCRETE DRILLING / DEMOLITION	18V LXT	DGA458				8,500	Paddle		●	●	●	●	●		
		DGA456				8,500	Slide		●	●	●	●	●		
		DGA455				8,500	Paddle		●	●		●	●		
		DGA454				8,500	Slide		●	●		●	●		
		DGA452				11,000	Slide		●				●		
		DGA469	DGA519			3,000 - 8,500	Paddle		●	●	●	●	●	●	●
CUTTING (CONCRETE / METAL)	18V + 18V LXT				DGA700	7,800	Trigger		●	●	●	●	●		
						DGA900	6,000	Trigger		●	●	●	●	●	
					DGA701	7,800	Trigger	●	●	●	●	●	●		
GRINDING					DGA901	6,000	Trigger	●	●	●	●	●			



**18Vx2 LXT**

### DGA700 180mm

**Cordless Angle Grinder**

**High power for heavy duty operation. Fast Cutting / Grinding**

- Anti-vibration rubber provides less vibration, allowing comfortable operation
- Ergonomically designed battery indicator handle with soft grip
- Over-Discharge and Overheat protection
- High maneuverability in any angle since it is possible to grab the center of gravity
- Large switch lever with lock-off function (without lock-on function).
- Lock-off function prevents the switch lever from being accidentally pulled.

<b>Wheel Diameter</b>	180 mm (7")
<b>No Load Speed (RPM)</b>	7,800
<b>Vibration Level : Surface grinding</b>	7.5 m/s <sup>2</sup>
<b>Sound Pressure Level / Sound Power Level</b>	88 dB(A) / 99 dB(A)
<b>Dimensions (L x W x H) (without battery)</b>	499x200x158 mm
<b>Net weight (without battery)</b>	6.0 kg

**Standard Equipment:** Toolless Wheel Cover, Side Handle, Lock Nut Wrench

**AVAILABLE VARIANTS**

**"Z" VARIANT**

**DGA700 ZK**  
TOOL ONLY WITH PLASTIC CARRYING CASE  
(DOES NOT INCLUDE BATTERY / CHARGER)

**18Vx2 LXT**

### DGA900 230mm

**Cordless Angle Grinder**

**High power for heavy duty operation. Fast Cutting / Grinding**

- Anti-vibration rubber provides less vibration, allowing comfortable operation
- Ergonomically designed battery indicator handle with soft grip
- Over-Discharge and Overheat protection
- High maneuverability in any angle since it is possible to grab the center of gravity
- Large switch lever with lock-off function (without lock-on function).
- Lock-off function prevents the switch lever from being accidentally pulled.

<b>Wheel Diameter</b>	230 mm (9")
<b>No Load Speed (RPM)</b>	6,000
<b>Vibration Level : Surface grinding</b>	7.5 m/s <sup>2</sup>
<b>Sound Pressure Level / Sound Power Level</b>	88 dB(A) / 99 dB(A)
<b>Dimensions (L x W x H) (without battery)</b>	499x250x158 mm
<b>Net weight (without battery)</b>	8.0 kg

**Standard Equipment:** Toolless Wheel Cover, Side Handle, Lock Nut Wrench

**AVAILABLE VARIANTS**

**"Z" VARIANT**

**DGA900 ZK**  
TOOL ONLY WITH PLASTIC CARRYING CASE  
(DOES NOT INCLUDE BATTERY / CHARGER)

**DGA701** 180mm 18Vx2 | **LXT**

**Cordless Angle Grinder**



**High power for heavy duty operation. Fast Cutting / Grinding**

- Anti-vibration rubber provides less vibration, allowing comfortable operation
- Ergonomically designed battery indicator handle with soft grip
- Over-Discharge and Overheat protection
- High maneuverability in any angle since it is possible to grab the center of gravity
- Large switch lever with lock-off function (without lock-on function).
- Lock-off function prevents the switch lever from being accidentally pulled.

**BL AFT XPT AWS**

Wheel Diameter	180 mm (7")
No Load Speed (RPM)	7,800
Vibration Level : Surface grinding	7.5 m/s <sup>2</sup>
Sound Pressure Level / Sound Power Level	88 dB(A) / 99 dB(A)
Dimensions (L x W x H) (without battery)	499x200x158 mm
Net weight (without battery)	6.0 kg

**Standard Equipment:** Toolless Wheel Cover, Side Handle, Lock Nut Wrench

**AVAILABLE VARIANTS**

5.0Ah	"Z" VARIANT
<b>DGA701 T2U1</b> INCLUDES 2 BATTERIES + 2PORT CHARGER + BLUETOOTH CHIP +PLASTIC CARRY CASE	<b>DGA701 ZKU</b> TOOL ONLY WITH BLUETOOTH CHIP AND PLASTIC CARRYING CASE (DOES NOT INCLUDE BATTERY / CHARGER / )

**DGA901** 230mm 18Vx2 | **LXT**

**Cordless Angle Grinder**



**High power for heavy duty operation. Fast Cutting / Grinding**

- Anti-vibration rubber provides less vibration, allowing comfortable operation
- Ergonomically designed battery indicator handle with soft grip
- Over-Discharge and Overheat protection
- High maneuverability in any angle since it is possible to grab the center of gravity
- Large switch lever with lock-off function (without lock-on function).
- Lock-off function prevents the switch lever from being accidentally pulled.

**BL AFT XPT AWS**

Wheel Diameter	230 mm (9")
No Load Speed (RPM)	6,000
Vibration Level : Surface grinding	7.5 m/s <sup>2</sup>
Sound Pressure Level / Sound Power Level	88 dB(A) / 99 dB(A)
Dimensions (L x W x H) (without battery)	499x250x158 mm
Net weight (without battery)	8.0 kg



**Standard Equipment:** Toolless Wheel Cover, Side Handle, Lock Nut Wrench

**AVAILABLE VARIANTS**

5.0Ah	"Z" VARIANT
<b>DGA901 T2U1</b> INCLUDES 2 BATTERIES + 2PORT CHARGER + BLUETOOTH CHIP +PLASTIC CARRY CASE	<b>DGA901ZKU1</b> TOOL ONLY WITH BLUETOOTH CHIP AND PLASTIC CARRYING CASE (DOES NOT INCLUDE BATTERY / CHARGER / )

**DGA458** 115mm 18V | **LXT**

**Cordless Angle Grinder**

**PADDLE SWITCH**

**Excellent Performance as powerful as AC model with highly enhanced Brushless DC motor**

- Paddle type on/off switch, Anti-restart function and Electric Brake.
- AFT function shuts down the tool, if the rotation speed suddenly slows down.
- Automatic speed control :Automatically changes the cutting speed according to load condition for an optimum operation. Handles heavy load with Excellent Cooling Function.
- High efficiency and More work amount by Brushless DC motor

**BL XPT ADTAFT**

Wheel diameter	115mm (4-1/2")
No load speed (rpm)	8,500
Dimensions (L x W x H)	362x130x151mm (14-1/4"x5-1/8"x5-15/16")
Net weight	2.6kg (5.8lbs)



**Standard Equipment:** Lock nut wrench, Side grip.

**AVAILABLE VARIANTS**

5.0Ah	3.0Ah	"Z" VARIANT
		<b>DGA458 Z</b> TOOL ONLY (DOES NOT INCLUDE BATTERY / CHARGER OR CARRY CASE)

**DGA456** 115mm 18V | **LXT**

**Cordless Angle Grinder**

**SLIDE SWITCH**

**Excellent Performance as powerful as AC model with highly enhanced Brushless DC motor**

- Slide type on/off switch, Anti-restart function and Electric Brake.
- AFT function shuts down the tool, if the rotation speed suddenly slows down.
- Automatic speed control :Automatically changes the cutting speed according to load condition for an optimum operation. Handles heavy load with Excellent Cooling Function.
- High efficiency and More work amount by Brushless DC motor

**BL XPT ADTAFT**

Wheel diameter	115mm (4-1/2")
No load speed (rpm)	8,500
Dimensions (L x W x H)	362x130x151mm (14-1/4"x5-1/8"x5-15/16")
Net weight	2.6kg (5.7lbs)

**Standard Equipment:** Lock nut wrench, Side grip.

**AVAILABLE VARIANTS**



5.0Ah	3.0Ah	"Z" VARIANT
		<b>DGA456 Z</b> TOOL ONLY (DOES NOT INCLUDE BATTERY / CHARGER OR CARRY CASE)

- DRILLING / FIXING
- CONCRETE DRILLING / DEMOLITION
- MIXING / STIRRING
- CUTTING (CONCRETE / METAL)
- GRINDING
- SANDING / POLISHING
- SAWING
- MULTI-TOOL
- ROUTERS / PLANERS
- NAILERS / STAPLERS
- HEAT GUN / LASER
- CLEANING
- OPE
- JBSITE TOOLS
- SPECIALTY TOOLS
- HAND TOOLS / COMBINATION SET
- TOOL HOLDERS AND POUCHES / MAKPAC SYSTEM

DRILLING / FIXING
CONCRETE DRILLING / DEMOLITION
MIXING / STIRRING
CUTTING (CONCRETE / METAL)
GRINDING
SANDING / POLISHING
SAWING
MULTI-TOOL
ROUTERS / PLANERS
NAILERS / STAPLERS
HEAT GUN / LASER
CLEANING
OPE
JOB SITE TOOLS
SPECIALTY TOOLS
HAND TOOLS / COMBINATION SET
TOOL HOLDERS AND POUCHES / MAKPAC SYSTEM

**DGA455** 115mm 18V | *LXT*

**Cordless Angle Grinder**

**PADDLE SWITCH**

**Excellent Performance as powerful as AC model with highly enhanced Brushless DC motor**

- Paddle type on/off switch and Anti-restart function.
- AFT function shuts down the tool, if the rotation speed suddenly slows down.
- Automatic speed control : Automatically changes the cutting speed according to load condition for an optimum operation. Handles heavy load with Excellent Cooling Function.
- High efficiency and More work amount by Brushless DC motor.



Wheel diameter	115mm (4-1/2")
No load speed (rpm)	8,500
Dimensions (L x W x H)	362x130x145mm (14-1/4"x5-1/8"x5-3/4")
Net weight	2.5kg (5.6lbs)

**Standard Equipment:** Lock nut wrench, Side grip.

5.0Ah	3.0Ah	"Z" VARIANT
<b>DGA455 RTJ</b> INCLUDES 2 BATTERIES / 1 CHARGER / MAKPAC CONNECTOR CASE	<b>DGA455 RFJ</b> INCLUDES 2 BATTERIES / 1 CHARGER / MAKPAC CONNECTOR CASE	<b>DGA455 Z</b> TOOL ONLY (DOES NOT INCLUDE BATTERY / CHARGER OR CARRY CASE)

**DGA454** 115mm 18V | *LXT*

**Cordless Angle Grinder**



**SLIDE SWITCH**

**Excellent Performance as powerful as AC model with highly enhanced Brushless DC motor**

- Slide type on/off switch and Anti-restart function.
- AFT function shuts down the tool, if the rotation speed suddenly slows down.
- Automatic speed control : Automatically changes the cutting speed according to load condition for an optimum operation. Handles heavy load with Excellent Cooling Function.
- High efficiency and More work amount by Brushless DC motor.



Wheel diameter	115mm (4-1/2")
No load speed (rpm)	8,500
Dimensions (L x W x H)	362x130x145mm (14-1/4"x5-1/8"x5-3/4")
Net weight	2.5kg (5.6lbs)

**Standard Equipment:** Lock nut wrench, Side grip.

5.0Ah	3.0Ah	"Z" VARIANT
<b>DGA454 RTJ</b> INCLUDES 2 BATTERIES / 1 CHARGER / MAKPAC CONNECTOR CASE	<b>DGA454 RFJ</b> INCLUDES 2 BATTERIES / 1 CHARGER / MAKPAC CONNECTOR CASE	<b>DGA454 Z</b> TOOL ONLY (DOES NOT INCLUDE BATTERY / CHARGER OR CARRY CASE)

**DGA452** 115mm

**Cordless Angle Grinder**



**SLIDE SWITCH**

**Powerful angle grinder now free from cord.**

- Capable of using wheels / discs for AC Grinders.
- Easy-to-grip, small circumference motor housing.
- Anti-restart function for safety (with warning lamp).
- Electronic current limiter (with warning lamp).



Wheel diameter	115mm (4-1/2")
No load speed (rpm)	11,000
Dimensions (L x W x H)	317x129x126mm (12-1/2"x5-1/8"x5")
Net weight	2.0kg (4.4lbs)

**Standard Equipment:** Lock nut wrench, Side grip.

**AVAILABLE VARIANTS**

5.0Ah	3.0Ah	"Z" VARIANT
<b>DGA452 RTJ</b> 2 BATTERIES / 1 CHARGER IN MAKPAC CASE		<b>DGA452 Z</b> TOOL ONLY (DOES NOT INCLUDE BATTERY / CHARGER OR CARRY CASE)



## AC Angle Grinders - Comparison Chart

	GRINDER	POWER	NO LOAD SPEED	WEIGHT	SYSTEM	SWITCH	HANDLE	ANTI RESTART	SOFT START	CONSTANT SPEED	VARIABLE SPEED	TORQUE LIMITER	MECHANICAL BRAKE	
100mm	N9500N	570W	12000 rpm	1.6kg		TOGGLE								DRILLING / FIXING
	9553HN	710W	11000 rpm	1.5kg		SLIDE								CONCRETE DRILLING / DEMOLITION
	9556HN	840W	11000 rpm	1.6kg		SLIDE								
	9556HP	840W	11000 rpm	1.7kg		PADDLE								
	GA4040Z	1,100W	11000 rpm	2.2kg	SJSII	SLIDE								
	GA4050	1,300W	11000 rpm	2,3kg		PADDLE								
	GA4040CZ	1,400W	2,800-11,000 rpm	2.3kg	SJSII	SLIDE		•	•	•	•			MIXING / STIRRING
115mm	9521NB	670	12000 rpm	01.3kg		SLIDE								CUTTING (CONCRETE / METAL)
	9554HN	710W	10000 rpm	1.6kg		SLIDE								
	9557HN	840W	11000 rpm	1.7kg		SLIDE								
	9557HP	840W	11000 rpm	1.7kg		PADDLE								
	GA4540Z	1,100W	11000 rpm	2.3kg	SSII	SLIDE								
	9564PZ	1,100W	12000 rpm	2.4kg	SJS	PADDLE								GRINDING
	GA4550	1,300W	11000 rpm	2.4kg		PADDLE								
	GA4550R	1,300W	11000 rpm	2.4kg		PADDLE		•	•					
	GA4540CZ	1,400W	2,800-11,000 rpm	2.4kg	SJSII	SLIDE		•	•	•	•			
	9564PC	1,400W	12000 rpm	2.4kg	SJS	PADDLE		•	•	•				SANDING / POLISHING
	GA4591	1900W	11000 rpm	2.6kg	SJSII	SLIDE		•	•	•	•		•	
	GA4592	1900W	11000 rpm	2.6kg	SJSII	SLIDE		•	•	•				
	GA4594	1900W	11000 rpm	2.6kg	SJSII	PADDLE		•	•	•			•	
	GA4595	1900W	11000 rpm	2.6kg	SJSII	PADDLE		•	•	•				SAWING
125mm	9522NB	670W	9500 rpm	1.3kg		SLIDE								MULTI-TOOL
	9555HN	710W	11000 rpm	1.6kg		SLIDE								
	9558HN	840W	11000 rpm	1.8kg		SLIDE								
	9558HP	840W	11000 rpm	1.8kg		PADDLE								
	9015B	1,050	10000 rpm	2.4kg		LARGE TRIGGER								ROUTERS / PLANERS
	GA5010	1,050	12000 rpm	1.6kg		FINGER TRIGGER								
	GA5040Z	1,100W	11000 rpm	2.4kg	SJSII	SLIDE								
	9565PZ	1,100W	12000 rpm	2.4kg	SJS	PADDLE								
	GA5050	1,300W	11000 rpm	2.5kg		PADDLE								
	GA5050R	1,300W	11000 rpm	2.5kg		PADDLE		•	•					NAILERS / STAPLERS
	GA5040CZ	1,400W	2,800-11,000 rpm	2.5kg	SJSII	SLIDE		•	•	•	•			
	9565PC	1,400W	12000 rpm	2.4kg	SJS	PADDLE				•				
	GA5080R	1,400W	12000 rpm	2.5kg	SJS/ X-LOCK	SLIDE		•	•	•				HEAT GUN / LASER
	GA5091	1900W	11000 rpm	2.6kg	SJSII	SLIDE		•	•	•	•		•	
	GA5092	1900W	11000 rpm	2.6kg	SJSII	SLIDE		•	•	•				
	GA5094	1900W	11000 rpm	2.6kg	SJSII	PADDLE		•	•	•			•	
	GA5095	1900W	11000 rpm	2.6kg	SJSII	PADDLE		•	•	•				CLEANING
	150mm	GA6010	1,050W	10000 rpm	2.7kg		FINGER TRIGGER							
180mm	GA7050	2,000W	8500 rpm	4.0kg		LARGE TRIGGER								OPE
	GA7020	2,200W	8500 rpm	5.6kg		LARGE TRIGGER								
	GA7062	2,200W	8500 rpm	5.5kg		LARGE TRIGGER	D SHAPE							
	GA7063	2,200W	8500 rpm	5.6kg	SJSII	LARGE TRIGGER	D SHAPE							
	GA7030	2,400W	8500 rpm	6.0kg		LARGE TRIGGER						•		JOBSITE TOOLS
	GA7040S	2,600W	8500 rpm	6.4kg		LARGE TRIGGER			•			•		
	GA7080	2700W	8500 rpm	6.4kg	SJSII	LARGE TRIGGER		•	•					
	GA7070	2,800W	8500 rpm	6.0kg	SJSII	LARGE TRIGGER		•	•	•			•	•
230mm	GA9050	2,000W	6600 rpm	4.7kg		LARGE TRIGGER								SPECIALTY TOOLS
	GA9050R	2,000W	6600 rpm	4.9kg		LARGE TRIGGER		•	•					
	GA9020	2,200W	6000 rpm	5.8kg		LARGE TRIGGER								
	GA9062	2,200W	6600 rpm	5.7kg		LARGE TRIGGER	D SHAPE							HAND TOOLS / COMBINATION SET
	GA9063	2,200W	6600 rpm	5.8kg	SJSII	LARGE TRIGGER	D SHAPE							
	GA9030	2,400W	6600 rpm	6.3kg		LARGE TRIGGER						•		
	GA9040S	2,600W	6600 rpm	6.7kg		LARGE TRIGGER			•			•		
	GA9080	2700W	6600 rpm	6.5kg	SJSII	LARGE TRIGGER		•	•					
	GA9070	2,800W	6600 rpm	6.3kg	SJSII	LARGE TRIGGER		•	•	•			•	•
														TOOL HOLDERS AND POUCHES / MAKPAC SYSTEM

- DRILLING / FIXING
- CONCRETE DRILLING / DEMOLITION
- MIXING / STIRRING
- CUTTING (CONCRETE / METAL)
- GRINDING**

### Angle Grinder - 570W (Toggle Switch) AC

#### N9500N 100mm (4")





<b>Continuous rating Input</b>	570W
<b>Capacity</b>	Depressed center wheel: 100mm (4") Wire cup brush: 75mm (3") Cut-off wheel: 110mm (4-3/8")
<b>No load speed</b>	Abrasive disc: 100mm (4")
<b>Dimensions (L x W x H)</b>	12,000rpm 245mm (9-5/8")
<b>Spindle thread</b>	M10 x 1.25
<b>Net weight</b>	1.6kg (3.5lbs)
<b>Power supply cord</b>	2.5m (8.2ft)

**Durable Aluminium Body**

- 12,000rpm for fast and efficient work.
- Switch is located on tail.
- Can be used with grinding wheel or optional diamond wheel.
- Externally accessible carbon brushes for fast and easy replacement.

**Standard Equipment:** Lock Nut Wrench, Grip.

- SANDING / POLISHING
- SAWING
- MULTI-TOOL
- ROUTERS / PLANERS
- NAILERS / STAPLERS
- HEAT GUN / LASER

### Angle Grinder - 670W (Toggle Switch) AC

#### 9520B 100mm (4")



<b>Continuous rating Input</b>	670 W
<b>Capacity</b>	Depressed center wheel: 100 mm (4") Wire cup brush: 75 mm (3") Abrasive Disc: 100 mm (4")
<b>No load speed</b>	Diamond wheel: 110 mm (4-3/8")
<b>Dimensions (L x W x H)</b>	12,000 rpm 259 mm (10-3/16")
<b>Spindle thread</b>	M10 x 1.5
<b>Net weight</b>	1.3 kg (2.9 lbs)
<b>Power supply cord</b>	2.5 m (8.2 ft)

**Incredibly light, yet powerful one-hand grinder with slender barrel grip and reduced noise.**

- Powerful grinding from an amazingly slim and trim angle grinder.

**Standard Equipment:** Lock Nut Wrench, Grip.





- CLEANING
- OPE
- JOBSITE TOOLS
- SPECIALTY TOOLS
- HAND TOOLS / COMBINATION SET
- TOOL HOLDERS AND POUCHES / MAKPAC SYSTEM

### Angle Grinder - 670W (Slide Switch) AC

#### 9521NB 115mm (4-1/2")

#### 9522NB 125mm (5")





<b>Continuous rating Input</b>	670 W	670 W
<b>Capacity</b>	Depressed center wheel: 115 mm (4 – 1/2") Abrasive disc: 115 mm (4 – 1/2") Diamond wheel: 115 mm (4 – 1/2")	Depressed center wheel: 125 mm (5") Abrasive disc: 125 mm (5") Diamond wheel: 125 mm (5")
<b>No load speed</b>	12,000rpm	9,500 rpm
<b>Dimensions</b>	262mm (10 – 3/8")	262 mm (10-3/8")
<b>Spindle thread</b>	DIN type	DIN type
<b>Net weight</b>	1.3 kg (2.8 lbs)	1.3 kg (2.9 lbs)
<b>Power supply cord</b>	2.5 m (8.2 ft)	2.5 m (8.2 ft)

**Compact and easy to grip**

- Incredibly light but powerful one-hand grinder with slimmer grip and less noise.

**Standard Equipment:** Lock Nut Wrench, Grip.







### Angle Grinder - 710W (Slide Switch)

	9553HN 100mm (4")	9554HN 115mm (4-1/2")	9555HN 125mm (5")
<b>Continuous rating input</b>	710W	710W	710W
<b>Wheel Diameter</b>	100 mm (4")	115 mm (4-1/2")	125 mm (5")
<b>No Load Speed (RPM)</b>	11,000	10,000	10,000
<b>Vibration Level</b>	-	Surface Grinding: 7.0 m/s <sup>2</sup> Disc Sanding: 2.5 m/s <sup>2</sup> or less	Surface Grinding: 8.5 m/s <sup>2</sup> Disc Sanding: 2.5 m/s <sup>2</sup> or less
<b>Sound Pressure Level</b>	-	85 dB(A)	85 dB(A)
<b>Sound Power Level</b>	-	96 dB(A)	96 dB(A)
<b>Dimensions (L x W x H)</b>	258x118x97 mm (10-1/8"x4-5/8"x3-13/16")	258x129x106 mm (10-1/8"x5-1/8"x4-3/16")	258x139x106 mm (10-1/8"x5-1/2"x4-3/16")
<b>Net weight</b>	1.5 kg (3.2 lbs)	1.6 kg (3.5 lbs)	1.6 kg (3.5 lbs)
<b>Power supply cord</b>	2.5 m (8.2 ft.)	2.5 m (8.2 ft.)	2.5 m (8.2 ft.)

**Compact yet powerful one-hand grinder.**

- Small circumference barrel grip for easy handling.
- Labyrinth construction prevents all ball bearings from dust and debris.
- Armature coated with protective zig zag varnish and field coated with powder varnish to protect the motor from dust and wire breakage, ensuring durability enough for masonry cutting.

**Standard Equipment:** Lock Nut Wrench, Grip.



DRILLING / FIXING

CONCRETE DRILLING / DEMOLITION

MIXING / STIRRING

CUTTING (CONCRETE / METAL)

GRINDING

SANDING / POLISHING

SAWING

MULTI-TOOL

ROUTERS / PLANERS

NAILERS / STAPLERS

HEAT GUN / LASER

CLEANING



OPE

JBSITE TOOLS

SPECIALTY TOOLS

HAND TOOLS / COMBINATION SET

TOOL HOLDERS AND POUCHES / MAKPAC SYSTEM

**710W MOTOR**   **325mm**



### Angle Grinder - 720W (Slide Switch)



	GA4030 100mm (4")	GA4530 115mm (4-1/2")	GA5030 125mm (5")
<b>Continuous rating input</b>	720W	720W	720W
<b>Wheel Diameter</b>	100 mm (4")	115 mm (4-1/2")	125 mm (5")
<b>No Load Speed (RPM)</b>	11,000	11,000	11,000
<b>Vibration Level</b>	Surface Grinding: 7.0 m/s <sup>2</sup> Disc Sanding: 2.5 m/s <sup>2</sup> or less	Surface Grinding: 7.5 m/s <sup>2</sup> Disc Sanding: 2.5 m/s <sup>2</sup>	Surface Grinding: 8.5 m/s <sup>2</sup> Disc Sanding: 2.5 m/s <sup>2</sup> or less
<b>Sound Pressure Level</b>	85 dB(A)	85 dB(A)	85 dB(A)
<b>Sound Power Level</b>	96 dB(A)	96 dB(A)	96 dB(A)
<b>Dimensions (L x W x H)</b>	266x117x95 mm (10-1/2"x4-5/8"x3-3/4")	266x128x103 mm (10-1/2"x5"x4-1/16")	266x140x108 mm (10-1/2"x5-1/2"x4-1/4")
<b>Net weight</b>	2.0 kg	2.2 kg	3.0 kg
<b>Power supply cord</b>	2.5 m (8.2 ft)	2.5 m (8.2 ft)	2.5 m (8.2 ft)

**Small circumference barrel grip and ergonomically designed side grip angle for easy handling.**

- Labyrinth construction protects all ball bearings from dust and debris.
- High quality motor with excellent heat-resistance.
- Small gear housing provides easy handling and high maneuverability.
- Motor field coated with protective powder varnish to protect from dust.

**Standard Equipment:** Lock Nut Wrench, Grip.



**720W MOTOR**   **459mm**



### Angle Grinder - 720W (Paddle Switch)



	GA4034 100mm (4")	GA5034 125mm (5")
<b>Continuous rating input</b>	720W	720W
<b>Wheel Diameter</b>	100 mm (4")	125 mm (5")
<b>No Load Speed (RPM)</b>	11,000	11,000
<b>Vibration Level</b>	Surface Grinding: 7.0 m/s <sup>2</sup> Disc Sanding: 2.5 m/s <sup>2</sup> or less	Surface Grinding: 8.0 m/s <sup>2</sup> Disc Sanding: 2.5 m/s <sup>2</sup> or less
<b>Sound Pressure Level</b>	85 dB(A)	86 dB(A)
<b>Sound Power Level</b>	96 dB(A)	97 dB(A)
<b>Dimensions (L x W x H)</b>	266x117x95 mm (10-1/2"x4-5/8"x3-3/4")	265x139x103 mm (10-3/8"x5-1/2"x4-1/16")
<b>Net weight</b>	2.0 kg	3.15 kg
<b>Power supply cord</b>	2.5 m (8.2 ft)	2.5 m (8.2 ft)

**Easy to operate paddle switch by the hand gripping motor housing.**

- Small circumference barrel grip and ergonomically designed side grip angle for easy handling.
- Labyrinth construction protects all ball bearings from dust and debris.
- High quality motor with excellent heat-resistance.
- Small gear housing provides easy handling and high maneuverability.
- Motor field coated with protective powder varnish to protect from dust.

**Standard Equipment:** Lock Nut Wrench, Grip.



**720W MOTOR**   **459mm**

- DRILLING / FIXING
- CONCRETE DRILLING / DEMOLITION
- MIXING / STIRRING
- CUTTING (CONCRETE / METAL)
- GRINDING







### Angle Grinder - 840W (Slide Switch)

	9556HN 100mm (4")	9557HN 115mm (4-1/2")	9558HN 125mm (5")
<b>Continuous rating Input</b>	840W	840W	840W
<b>Capacity</b>	Depressed center wheel: 100mm (4") Abrasive disc: 100mm (4") Diamond wheel: 100mm (4")	Depressed center wheel: 115mm (4-1/2") Abrasive disc: 115mm (4-1/2") Diamond wheel: 115mm (4-1/2")	Depressed center wheel: 125mm (5") Abrasive disc: 125mm (5") Diamond wheel: 125mm (5")
<b>No load speed</b>	11,000rpm	11,000rpm	11,000rpm
<b>Dimensions (L x W x H)</b>	271mm x 129mm x 106mm (10-5/8" x 5-1/8" x 4-3/16")	271mm x 129mm x 106mm (10-5/8" x 5-1/8" x 4-3/16")	271mm x 139mm x 106mm (10-5/8" x 5-1/2" x 4-3/16")
<b>Spindle thread</b>	DIN type	DIN type	DIN type
<b>Net weight</b>	2.0kg (4.4lbs)	2.0kg (4.4lbs)	2.1kg (4.6lbs)
<b>Power supply cord</b>	2.5m (8.2ft)	2.5m (8.2ft)	2.5m (8.2ft)

**High performance motor and high heat resistance.**

- Labyrinth construction protects all ball bearings from dust and debris.
- Small circumference barrel grip for easy handling.
- Shaft lock for easy wheel changes.
- Easier repairing of gear section assembled with key.

**Standard Equipment:** Lock Nut Wrench, Grip.

- SANDING / POLISHING
- SAWING
- MULTI-TOOL
- ROUTERS / PLANERS
- NAILERS / STAPLERS
- HEAT GUN / LASER







### Angle Grinder - 840W (Paddle Switch)

	9556HP 100mm (4")	9557HP 115mm (4-1/2")	9558HP 125mm (5")
<b>Continuous rating Input</b>	840W	840W	840W
<b>Capacity</b>	Depressed center wheel: 100mm (4") Abrasive disc: 100mm (4") Diamond wheel: 100mm (4")	Depressed center wheel: 115mm (4-1/2") Abrasive disc: 115mm (4-1/2") Diamond wheel: 115mm (4-1/2")	Depressed center wheel: 125mm (5") Abrasive disc: 125mm (5") Diamond wheel: 125mm (5")
<b>No load speed</b>	11,000rpm	11,000rpm	11,000rpm
<b>Dimensions (L x W x H)</b>	273mm x 129mm x 106mm (10-3/4" x 5-1/8" x 4-3/16")	273mm x 129mm x 106mm (10-3/4" x 5-1/8" x 4-3/16")	273mm x 129mm x 106mm (10-3/4" x 5-1/8" x 4-3/16")
<b>Spindle thread</b>	DIN type	DIN type	DIN type
<b>Net weight</b>	2.1kg (4.5lbs)	2.1kg (4.5lbs)	2.1kg (4.5lbs)
<b>Power supply cord</b>	2.5m (8.2ft)	2.5m (8.2ft)	2.5m (8.2ft)

**Ergonomic paddle switch featured.**

- Natural fit slim body to left and right hand for easy handling.
- Ergonomically designed paddle lever gives comfort to the fingers.
- Lock-off button built in the center of paddle lever.

**Standard Equipment:** Lock Nut Wrench, Grip.

- CLEANING
- OPE
- JOBSITE TOOLS
- SPECIALTY TOOLS
- HAND TOOLS / COMBINATION SET
- TOOL HOLDERS AND POUCHES / MAKPAC SYSTEM







### Angle Grinder - 1,050W (Large Trigger Switch)

	9015B 125mm (5")
<b>Continuous rating Input</b>	1,050W
<b>Capacity</b>	Depressed center wheel: 125mm (5") Wire cup brush: 90mm (3-1/2") Abrasive disc: 125mm (5") Diamond wheel: 125mm (5")
<b>No load speed</b>	10,000rpm
<b>Dimensions (L x W x H)</b>	381mm (15")
<b>Spindle thread</b>	DIN type, 5/8"-11UNC
<b>Net weight</b>	2.4kg (5.3lbs)
<b>Power supply cord</b>	2.5m (8.2ft)

**Big trigger switch for convenient operation.**

- Gear housing can be positioned at every 90 degrees.

**Standard Equipment:** Lock Nut Wrench, Grip.



### Angle Grinder - 1,050W (Large Trigger Switch) (Finger Trigger Switch)





	GA5011 125mm (5")	GA5010 125mm (5")	GA6010 150mm (6")
<b>Continuous rating input</b>	1,050W	1,050W	1,050W
<b>Wheel Diameter</b>	125 mm (5")	125 mm (5")	150 mm (6")
<b>No Load Speed (RPM)</b>	12,000	12,000	10,000
<b>Vibration Level</b>	Surface Grinding: 13.5 m/s <sup>2</sup>	Surface Grinding: 9.5 m/s <sup>2</sup> Disc Sanding: 2.5 m/s <sup>2</sup> or less	Surface Grinding: 9.5 m/s <sup>2</sup> Disc Sanding: 2.5 m/s <sup>2</sup>
<b>Sound Pressure Level</b>	90 dB(A)	89 dB(A)	90 dB(A)
<b>Sound Power Level</b>	101 dB(A)	100 dB(A)	101 dB(A)
<b>Dimensions (L x W x H)</b>	384x139x113 mm	356x139x112 mm	356x169x112 mm
<b>Net weight</b>	2.6kg	2.6 kg	2.7 kg
<b>Power supply cord</b>	2.5 m	2.5 m	2.5 m

**High durability**

- Large trigger switch (GA5011)
- Switch with easy-to-operate single-finger trigger. (GA5010, GA6010)
- Lightweight at only 2.6kg.
- High dust-proof construction.
- Ergonomically designed handle with rubberized grip provides more control and comfort.

**Standard Equipment:** Lock Nut Wrench, Grip.



- DRILLING / FIXING
- CONCRETE DRILLING / DEMOLITION
- MIXING / STIRRING
- CUTTING (CONCRETE / METAL)
- GRINDING
- SANDING / POLISHING
- SAWING
- MULTI-TOOL
- ROUTERS / PLANERS
- NAILERS / STAPLERS
- HEAT GUN / LASER
- CLEANING
- OPE
- JOBSITE TOOLS
- SPECIALTY TOOLS
- HAND TOOLS / COMBINATION SET
- TOOL HOLDERS AND POUCHES / MAKPAC SYSTEM



### Angle Grinder - 1,100W (Slide Switch) (SJS)







	9563HZ 100mm (4")	9565HZ 125mm (5")
<b>Continuous rating input</b>	1,100W	1,100W
<b>Wheel Diameter</b>	100 mm (4")	125 mm (5")
<b>No Load Speed (RPM)</b>	12,000	12,000
<b>Vibration Level</b>	Surface Grinding: 5.5 m/s <sup>2</sup> Anti-Vibration Side Grip: 7.5 m/s <sup>2</sup> Disc Sanding: 2.5 m/s <sup>2</sup> or less	Surface Grinding with Anti-Vibration Side Grip: 7.5 m/s <sup>2</sup> Disc Sanding: 2.5 m/s <sup>2</sup> or less
<b>Sound Pressure Level</b>	85 dB(A)	84 dB(A)
<b>Sound Power Level</b>	96 dB(A)	95 dB(A)
<b>Dimensions (L x W x H)</b>	299x120x103 mm (11-3/4"x4-3/4"x4")	299x139x103 mm (11-3/4"x5-1/2"x4")
<b>Net weight</b>	2.1 kg (4.6 lbs.)	2.3 kg (5.1 lbs)
<b>Power supply cord</b>	2.5 m (8.2 ft)	2.5 m (8.2 ft)

**High 1,100W power anti-dust motor.**

- Super Joint System absorbs shock caused by accidental wheel lock and protects gears.
- Housing shape is easy to grip because of internal Brush Holders.
- Labyrinth construction seals motor and bearings from contamination.

**Standard Equipment:** Lock Nut Wrench, Grip.



- SANDING / POLISHING
- SAWING
- MULTI-TOOL
- ROUTERS / PLANERS
- NAILERS / STAPLERS
- HEAT GUN / LASER
- CLEANING
- OPE
- JOBSITE TOOLS
- SPECIALTY TOOLS
- HAND TOOLS / COMBINATION SET
- TOOL HOLDERS AND POUCHES / MAKPAC SYSTEM



### Angle Grinder - 1,100W (Slide Switch) (SJS II)







	GA4040Z 100mm (4")	GA4540Z 115mm (4-1/2")	GA5040Z 125mm (5")
<b>Continuous rating input</b>	1,100W	1,100W	1,100W
<b>Wheel Diameter</b>	100 mm (4")	115 mm (4-1/2")	125 mm (5")
<b>No Load Speed (RPM)</b>	11,000	11,000	11,000
<b>Vibration Level</b>	Surface Grinding : 5.5 m/s <sup>2</sup> Disc Sanding with Anti-Vibration Side Grip: 2.5 m/s <sup>2</sup> or less	Surface Grinding : 6.0 m/s <sup>2</sup> Disc Sanding with Anti-Vibration Side Grip: 2.5 m/s <sup>2</sup> or less	Surface Grinding : 6.0 m/s <sup>2</sup> Disc Sanding with Anti-Vibration Side Grip: 2.5 m/s <sup>2</sup> or less
<b>Sound Pressure Level</b>	86 dB(A)	86 dB(A)	86 dB(A)
<b>Sound Power Level</b>	97 dB(A)	97 dB(A)	97 dB(A)
<b>Dimensions (L x W x H)</b>	303x117x111 mm (11-7/8"x4-5/8"x4-3/8")	303x130x116 mm (11-7/8"x5-1/8"x4-9/16")	303x140x116 mm (11-7/8"x5-1/2"x4-9/16")
<b>Net weight</b>	2.2 - kg (4.9 lbs)	2.3 kg (5.2 lbs)	2.4 (5.2 lbs)
<b>Power supply cord</b>	2.5 m (8.2 ft)	2.5 m (8.2 ft)	2.5 m (8.2 ft)

**"Super Joint System II" developed for effective vibration absorption.**

- Re-designed durable gear housing.
- Ergonomically best possible barrel grip.

**Standard Equipment:** Lock Nut Wrench, Grip.











- CLEANING
- OPE
- JOBSITE TOOLS
- SPECIALTY TOOLS
- HAND TOOLS / COMBINATION SET
- TOOL HOLDERS AND POUCHES / MAKPAC SYSTEM

- DRILLING / FIXING
- CONCRETE DRILLING / DEMOLITION
- MIXING / STIRRING
- CUTTING (CONCRETE / METAL)
- GRINDING

### Angle Grinder - 1,100W (Paddle Switch) (SJS) AC

#### 9565PZ 125mm (5")





<b>Continuous rating input</b>	1,100W
<b>Wheel Diameter</b>	125 mm (5")
<b>No Load Speed (RPM)</b>	12,000
<b>Vibration Level</b>	Surface Grinding: 9.5 m/s <sup>2</sup> Disc Sanding: 2.5 m/s <sup>2</sup> or less
<b>Sound Pressure Level</b>	85 dB(A)
<b>Sound Power Level</b>	96 dB(A)
<b>Dimensions (L x W x H)</b>	307x139x103 mm (12-1/8"x5-1/2"x4")
<b>Net weight</b>	2.4 kg (5.3 lbs)
<b>Power supply cord</b>	2.5 m (8.2 ft)

**PADDLE SWITCH**



**SUPER JOINT SYSTEM SJS**

**1,100W MOTOR**    **325mm**

**Standard Equipment:** Lock Nut Wrench, Grip.

**Easy-to-operate paddle type on/off switch.**

- Super Joint System absorbs shock caused by accidental wheel lock and protects gears.
- More durable gears and bearings.
- Electronic limiter & Electronic Controller.

- SANDING / POLISHING
- SAWING
- MULTI-TOOL
- ROUTERS / PLANERS
- NAILERS / STAPLERS
- HEAT GUN / LASER

### Angle Grinder - 1,200W (Slide Switch) (Anti Restart) (SJS) AC

#### 9561CR 115mm (4-1/2")

#### 9562CR 125mm (5")





<b>Continuous rating input</b>	1,200W	1,200W
<b>Wheel Diameter</b>	115 mm (4-1/2")	125 mm (5")
<b>No Load Speed (RPM)</b>	12,000	12,000
<b>Vibration Level</b>	Surface Grinding with Anti-Vibration Side Grip: 7.5 m/s <sup>2</sup> Disc Sanding: 2.5 m/s <sup>2</sup> or less	Surface Grinding with Anti-Vibration Side Grip: 7.5 m/s <sup>2</sup> Disc Sanding: 2.5 m/s <sup>2</sup> or less
<b>Sound Pressure Level</b>	83 dB(A)	83 dB(A)
<b>Sound Power Level</b>	94 dB(A)	94 dB(A)
<b>Dimensions (L x W x H)</b>	289x129x103 mm (11-3/8"x5-1/8"x4-1/16")	289x139x103 mm (11-3/8"x5-1/2"x4-1/16")
<b>Net weight</b>	2.2 kg (5.0 lbs)	2.2 kg (5.0 lbs)
<b>Power supply cord</b>	2.5 m (8.2 ft)	2.5 m (8.2 ft)

**SLIDE SWITCH**



**SUPER JOINT SYSTEM SJS**

**1,200W MOTOR**   **318mm**

**Standard Equipment:** Lock Nut Wrench, Grip.

**High 1,200W power anti-dust motor.**

- Super Joint System absorbs shock caused by accidental wheel lock and protects gears.
- Labyrinth construction protects motor and bearings from dirt/dust.
- Motor Protection from overload by Electronic Limiter.
- Anti-restart function.

- CLEANING
- OPE
- JOBSITE TOOLS
- SPECIALTY TOOLS
- HAND TOOLS / COMBINATION SET
- TOOL HOLDERS AND POUCHES / MAKAPAC SYSTEM

### Angle Grinder - 1,300W (Paddle Switch) AC

#### GA4050 100mm (4")

#### GA4550 115mm (4-1/2")



#### GA5050 125mm (5")



<b>Continuous rating input</b>	1,300W	1,300W	1,300W
<b>Wheel Diameter</b>	100 mm (4")	115 mm (4-1/2")	125 mm (5")
<b>No Load Speed (RPM)</b>	11,000	11,000	11,000
<b>Vibration Level</b>	Surface Grinding: 6.5 m/s <sup>2</sup> Disc Sanding: 2.5 m/s <sup>2</sup> or less	Surface Grinding: 7.0 m/s <sup>2</sup> Disc Sanding: 2.5 m/s <sup>2</sup>	Surface Grinding: 7.5 m/s <sup>2</sup> Disc Sanding: 2.5 m/s <sup>2</sup> or less
<b>Sound Pressure Level</b>	91 dB(A)	91 dB(A)	91 dB(A)
<b>Sound Power Level</b>	102 dB(A)	102 dB(A)	102 dB(A)
<b>Dimensions (L x W x H)</b>	325x117x110 mm (12-3/4"x4-5/8"x4-5/16")	325x130x117 mm (12-3/4"x5-1/8"x4-5/8")	325x140x117 mm (12-3/4"x5-1/2"x4-5/8")
<b>Net weight</b>	2.6 kg	2.8 kg	2.8 kg
<b>Power supply cord</b>	5 m (8.2 ft.)	2.5 m (8.2 ft.)	2.5 m

**PADDLE SWITCH**



**1,300W MOTOR**   **260mm**

**Standard Equipment:** Lock Nut Wrench, Grip.

**Powerful 1,300 W Motor with Paddle Switch Trigger**

- Enhanced shaft locking mechanism
- Toolless wheel cover - allows for fast and easy angle adjustment and installation/ removal of wheel cover
- Anti-drop holders allows to attach anti-drop strap, etc.
- Easy-to-hold barrel grip provides less hand fatigue and more control of the machine (Grip circumference smaller than 9564P series)



### Angle Grinder - 1,300W (Paddle Switch) (Anti-Restart Function)

	GA4550R 115mm (4-1/2")	GA5050R 125mm (5")
<b>Continuous rating input</b>	1,300W	1,300W
<b>Wheel Diameter</b>	115 mm (4-1/2")	125 mm (5")
<b>No Load Speed (RPM)</b>	11,000	11,000
<b>Vibration Level</b>	Surface Grinding: 7.0 m/s <sup>2</sup> Disc Sanding: 2.5 m/s <sup>2</sup>	Surface Grinding: 7.5 m/s <sup>2</sup> Disc Sanding: 2.5 m/s <sup>2</sup> or less
<b>Sound Pressure Level</b>	91 dB(A)	91 dB(A)
<b>Sound Power Level</b>	102 dB(A)	102 dB(A)
<b>Dimensions (L x W x H)</b>	325x130x117 mm (12-3/4" x 5-1/8" x 4-5/8")	325x140x117 mm (12-3/4" x 5-1/2" x 4-5/8")
<b>Net weight</b>	2.8 kg	2.8 kg
<b>Power supply cord</b>	2.5 m (8.2 ft.)	2.5 m

**Powerful 1,300 W Motor with Paddle Switch Trigger, Anti Restart and Soft Start**

- Enhanced shaft locking mechanism
- Toolless wheel cover - allows for fast and easy angle adjustment and installation/ removal of wheel cover
- Anti-drop holders allows to attach anti-drop strap, etc.
- Easy-to-hold barrel grip provides less hand fatigue and more control of the machine (Grip circumference smaller than 9564P series)

**Standard Equipment:** Lock Nut Wrench, Grip.

**1,300W MOTOR**    **260mm**

- DRILLING / FIXING
- CONCRETE DRILLING / DEMOLITION
- MIXING / STIRRING
- CUTTING (CONCRETE / METAL)
- GRINDING



### Angle Grinder - 1,400W (Slide Switch) (SJS II) (Anti-Restart Function)



	GA4040CZ 100mm (4")	GA4540CZ 115mm (4-1/2")	GA5040CZ 125mm (5")
<b>Continuous rating input</b>	1,400W	1,400W	1,400W
<b>Wheel Diameter</b>	100 mm (4")	115 mm (4-1/2")	125 mm (5")
<b>No Load Speed (RPM)</b>	2,800-11,000	2,800 - 11,000	2,800-11,000
<b>Vibration Level</b>	Surface Grinding : 5.0 m/s <sup>2</sup> Disc Sanding : 2.5 m/s <sup>2</sup> or less	Surface Grinding : 5.5 m/s <sup>2</sup> Disc Sanding : 2.5 m/s <sup>2</sup>	Surface Grinding : 5.5 m/s <sup>2</sup> Disc Sanding : 2.5 m/s <sup>2</sup>
<b>Sound Pressure Level</b>	86 dB(A)	86 dB(A)	86 dB(A)
<b>Sound Power Level</b>	97 dB(A)	97 dB(A)	97 dB(A)
<b>Dimensions (L x W x H)</b>	303x117x111 mm (11-7/8" x 4-5/8" x 4-3/8")	303x130x116 mm (11-7/8" x 5-1/8" x 4-9/16")	303x140x116 mm (11-7/8" x 5-1/2" x 4-9/16")
<b>Net weight</b>	2.3 kg (5.1 lbs)	2.4 kg (5.4 lbs)	2.5 kg (5.6 lbs)
<b>Power supply cord</b>	2.5 m (8.2 ft)	2.5 m (8.2 ft)	2.5 m (8.2 ft)

**"Super Joint System II" developed for effective vibration absorption.**

- Electronic current limiter, speed control and soft start.
- Anti-restart function.
- Re-designed durable gear housing.
- Ergonomically best possible barrel grip.

**Standard Equipment:** Lock Nut Wrench, Grip.

**SJS II SUPER JOINT SYSTEM**    **318mm**

**1,400W MOTOR**   

- SANDING / POLISHING
- SAWING
- MULTI-TOOL
- ROUTERS / PLANERS
- NAILERS / STAPLERS
- HEAT GUN / LASER



### Angle Grinder - 1,400W (Paddle Switch) (SJS)



	9564PC 115mm (4-1/2")
<b>Continuous rating input</b>	1,400W
<b>Wheel Diameter</b>	115 mm (4-1/2")
<b>No Load Speed (RPM)</b>	12,000
<b>Vibration Level</b>	Surface Grinding: 10 m/s <sup>2</sup>
<b>Sound Pressure Level</b>	81 dB(A)
<b>Sound Power Level</b>	92 dB(A)
<b>Dimensions (L x W x H)</b>	307x129x103 mm (12-1/8" x 5-1/8" x 4")
<b>Net weight</b>	2.4 kg (5.3 lbs)
<b>Power supply cord</b>	2.5 m (8.2 ft)

**High 1,400W power anti-dust motor in small circumference barrel grip body.**

- Super Joint System absorbs shock caused by accidental wheel lock and protects gears.
- Automatic brush cut-off.
- Labyrinth construction, seals motor and bearings from contamination.
- Electronic speed control with soft-start allows smooth and consistent performance

**Standard Equipment:** Lock Nut Wrench, Grip.

**SJS SUPER JOINT SYSTEM**    **318mm**

**1,400W MOTOR**   

- CLEANING
- OPE
- JOB SITE TOOLS
- SPECIALTY TOOLS
- HAND TOOLS / COMBINATION SET
- TOOL HOLDERS AND POUCHES / MAKPAC SYSTEM

- DRILLING / FIXING
- CONCRETE DRILLING / DEMOLITION
- MIXING / STIRRING
- CUTTING (CONCRETE / METAL)
- GRINDING



**NEW**

SLIDE SWITCH

**1700W MOTOR** 127V  
**1900W MOTOR** 220V - 240V

**SJS** **AFT** 264mm

Angle Grinder - 1,900W (Slide Switch) (Anti-Restart Function)		
	GA4591 115mm (4-1/2")	GA5091 125mm (5")
Continuous rating Input	1,900W (127V : 1700W)	1,900W (127V : 1700W)
Wheel diameter	115 mm (4-1/2")	125 mm (5")
No load speed (RPM)	2,800 - 11,500	2,800 - 11,500
Dimensions at grip portion (W x H)	66 x 59 mm	66 x 59 mm
Circumference of grip portion	205 mm	205mm
Sound pressure level	90 dB(A)	90 dB(A)
Sound power level	98 dB(A)	98 dB(A)
Dimensions (L x W x H)	349 x 130 x 129 mm	349 x 140 x 129 mm
Net weight (Tool Body only)	2.4 kg	2.4 kg

**Powerful 1,900 W Motor with Slide Switch , Anti Restart, Soft Start, Variable speed & Mechanical Brake**

- Enhanced shaft locking mechanism
- Toolless wheel cover - allows for fast and easy angle adjustment and installation/ removal of wheel cover
- Anti-drop holders allows to attach anti-drop strap, etc.
- Easy-to-hold barrel grip provides less hand fatigue and more control of the machine (Grip circumference smaller than 9564P series)

**Standard Equipment:** Lock Nut Wrench, Grip.

- SANDING / POLISHING
- SAWING
- MULTI-TOOL
- ROUTERS / PLANERS
- NAILERS / STAPLERS
- HEAT GUN / LASER



**NEW**

SLIDE SWITCH

**1700W MOTOR** 127V  
**1900W MOTOR** 220V - 240V

**SJS** **AFT** 264mm

Angle Grinder - 1,900W (Slide Switch) (Anti-Restart Function)		
	GA4592 115mm (4-1/2")	GA5092 125mm (5")
Continuous rating Input	1,900W (127V : 1700W)	1,900W (127V : 1700W)
Wheel diameter	115 mm (4-1/2")	125 mm (5")
No load speed (RPM)	11,500	11,500
Dimensions at grip portion (W x H)	66 x 59 mm	66 x 59 mm
Circumference of grip portion	205 mm	205mm (8-1/8")
Sound pressure level	93dB(A)	93 dB(A)
Sound power level	101 dB(A)	101dB(A)
Dimensions (L x W x H)	326x 130 x 123 mm	326x 140 x 123 mm
Net weight (Tool Body only)	2.2 kg	2.2 kg

**Powerful 1,900 W Motor with Slide Switch Trigger, Anti Restart, Soft Start**

- Enhanced shaft locking mechanism
- Toolless wheel cover - allows for fast and easy angle adjustment and installation/ removal of wheel cover
- Anti-drop holders allows to attach anti-drop strap, etc.
- Easy-to-hold barrel grip provides less hand fatigue and more control of the machine (Grip circumference smaller than 9564P series)

**Standard Equipment:** Lock Nut Wrench, Grip.

- CLEANING
- OPE
- JOBSITE TOOLS
- SPECIALTY TOOLS
- HAND TOOLS / COMBINATION SET
- TOOL HOLDERS AND POUCHES / MAKPAC SYSTEM



**NEW**

PADDLE SWITCH

**1700W MOTOR** 127V  
**1900W MOTOR** 220V - 240V

**SJS** **AFT** 264mm

Angle Grinder - 1,900W (Paddle Switch) (Anti-Restart Function)		
	GA4594 115mm (4-1/2")	GA5094 125mm (5")
Continuous rating Input	1,900W (127V : 1700W)	1,900W (127V : 1700W)
Wheel Diameter	115 mm (4-1/2")	125 mm (5")
Hole Diameter	11,500	11,500
No Load Speed (RPM)	66 x 59 mm	66 x 59 mm
Circumference of grip portion	207 mm	207mm
Cutting depth	90 dB(A)	90 dB(A)
Dimensions (L x W x H)	98 dB(A)	98 dB(A)
Net weight	349 x 130 x 129 mm	349 x 140 x 129 mm
	2.4 kg	2.4 kg

**Powerful 1,900 W Motor with Paddle Switch , Anti Restart, Soft Start, Mechanical Brake**

- Enhanced shaft locking mechanism
- Toolless wheel cover - allows for fast and easy angle adjustment and installation/ removal of wheel cover
- Anti-drop holders allows to attach anti-drop strap, etc.
- Easy-to-hold barrel grip provides less hand fatigue and more control of the machine (Grip circumference smaller than 9564P series)



**Standard Equipment:** Lock Nut Wrench, Grip.



**NEW**

**PADDLE SWITCH**

**1700W MOTOR** 127V  
**1900W MOTOR** 220V - 240V

  **264mm**

### Angle Grinder - 1,900W (Paddle Switch) (Anti-Restart Function)

	<b>GA4595</b> 115mm (4-1/2")	<b>GA5095</b> 125mm (5")
<b>Continuous rating Input</b>	1,900W (127V : 1700W)	1,900W (127V : 1700W)
<b>Wheel diameter</b>	115 mm (4-1/2")	125 mm (5")
<b>No load speed (RPM)</b>	11,500	11,500
<b>Dimensions at grip portion (W x H)</b>	66 x 59 mm	66 x 59 mm
<b>Circumference of grip portion</b>	207 mm	207mm (8-1/8")
<b>Sound pressure level</b>	93dB(A)	93 dB(A)
<b>Sound power level</b>	101 dB(A)	101dB(A)
<b>Dimensions (L x W x H)</b>	326x 130 x 123 mm	326x 140 x 123 mm
<b>Net weight (Tool Body only)</b>	2.2 kg	2.2 kg

**Powerful 1,900 W Motor with Paddle Switch , Anti Restart & Soft Start**

- Enhanced shaft locking mechanism
- Toolless wheel cover - allows for fast and easy angle adjustment and installation/ removal of wheel cover
- Anti-drop holders allows to attach anti-drop strap, etc.
- Easy-to-hold barrel grip provides less hand fatigue and more control of the machine (Grip circumference smaller than 9564P series)

**Standard Equipment:** Lock Nut Wrench, Grip.

- DRILLING / FIXING
- CONCRETE DRILLING / DEMOLITION
- MIXING / STIRRING
- CUTTING (CONCRETE / METAL)
- GRINDING



**1650W MOTOR** 115V  
**2000W MOTOR** 220V - 240V **153mm**

**Standard Equipment:** Lock Nut Wrench, Grip.

### Angle Grinder - 1,650W - 2,000W (Finger Trigger Switch)

<b>GA7001</b> 180mm (7")	
<b>Continuous rating input</b>	115V : 1,650 W
<b>Capacity</b>	220 - 240V : 2,000 W
	Depressed center wheel : 180 mm (7")
	Wire cup brush : 110 mm (4-3/8")
	Cut-off wheel : 180 mm (7")
	Abrasive disc : 180 mm (7")
<b>No load speed</b>	8,000 rpm
<b>Overall length</b>	411.5 mm (16-1/4")
<b>Spindle thread</b>	DIN type
<b>Net weight</b>	5.7 kg (12.6 lbs)
<b>Power supply cord</b>	2.5 m (8.2 ft)

**A tough contender, very rugged and powerful.**



- Powerful motor in tough, aluminium body.

**Standard Equipment:** Lock Nut Wrench, Grip.

- SANDING / POLISHING
- SAWING
- MULTI-TOOL
- ROUTERS / PLANERS
- NAILERS / STAPLERS
- HEAT GUN / LASER



**1650W MOTOR** 127V  
**2000W MOTOR** 220V - 240V

  **204mm**

### Angle Grinder - 1,650W - 2,000W (Large Trigger Switch)

	<b>GA7050</b> 180mm (7")	<b>GA9050</b> 230mm (9")
<b>Continuous rating input</b>	127V : 1,650 W	127V : 1,650 W
	220 - 240V : 2,000 W	220 - 240V : 2,000 W
<b>Wheel Diameter</b>	180 mm (7")	230 mm (9")
<b>No Load Speed (RPM)</b>	8,500	6,600
<b>Vibration Level</b>	Surface Grinding: 6.5 m/s <sup>2</sup> Disc Sanding: 4.0 m/s <sup>2</sup>	Surface Grinding: 5.5 m/s <sup>2</sup> Disc Sanding: 2.5 m/s <sup>2</sup>
<b>Sound Pressure Level</b>	94 dB(A)	94 dB(A)
<b>Sound Power Level</b>	105 dB(A)	105 dB(A)
<b>Dimensions (L x W x H)</b>	432x200x132 mm (17"x7-7/8"x5-3/16")	432x250x132 mm (17"x9-7/8"x5-3/16")
<b>Net weight</b>	3.98 kg (8.8 lbs)	4.64 kg (10.2 lbs)
<b>Power supply cord</b>	2.5 m (8.2 ft)	2.5 m (8.2 ft)

**Most compact in its class**

- Small and rotatable gear housing.
- Large trigger switch.
- Light weight.

**Standard Equipment:** Lock Nut Wrench, Grip.

- CLEANING
- OPE
- JOBSITE TOOLS
- SPECIALTY TOOLS
- HAND TOOLS / COMBINATION SET
- TOOL HOLDERS AND POUCHES / MAKPAC SYSTEM

- DRILLING / FIXING
- CONCRETE DRILLING / DEMOLITION
- MIXING / STIRRING
- CUTTING (CONCRETE / METAL)
- GRINDING**



**1650W** MOTOR 127V  
**2000W** MOTOR 220V - 240V

**Angle Grinder - 1,650W-2,000W (Anti Restart) (Large Trigger Switch)**



	<b>GA7050R 180mm (7")</b>	<b>GA9050R 230mm (9")</b>
<b>Continuous rating input</b>	127V : 1,650 W 220 - 240V : 2,000 W	127V : 1,650 W 220 - 240V : 2,000 W
<b>Wheel Diameter</b>	180 mm (7")	230 mm (9")
<b>No Load Speed (RPM)</b>	8,500	6,600
<b>Vibration Level</b>	Surface Grinding: 6.5 m/s <sup>2</sup> Disc Sanding: 4.0 m/s <sup>2</sup>	Surface Grinding: 5.5 m/s <sup>2</sup> Disc Sanding: 2.5 m/s <sup>2</sup>
<b>Sound Pressure Level</b>	94 dB(A)	94 dB(A)
<b>Sound Power Level</b>	105 dB(A)	105 dB(A)
<b>Dimensions (L x W x H)</b>	455x200x132 mm (17-7/8"x7-7/8"x5-3/16")	455x250x132 mm (17-7/8"x9-7/8"x5-3/16")
<b>Net weight</b>	4.6 kg (10.3 lbs.)	4.8 (10.6 lbs)
<b>Power supply cord</b>	2.5 m (8.2 ft)	2.5 m (8.2 ft)

**Most compact in its class**

- Small and rotatable gear housing.
- Large trigger switch.
- Light weight.

**Standard Equipment:** Lock Nut Wrench, Grip.

- SANDING / POLISHING
- SAWING
- MULTI-TOOL
- ROUTERS / PLANERS
- NAILERS / STAPLERS
- HEAT GUN / LASER
- CLEANING



**2,200W** MOTOR

**Angle Grinder - 2,200W (Large Trigger Switch)**



	<b>GA7020 180mm (7")</b>	<b>GA9020 230mm (9")</b>
<b>Continuous rating input</b>	2,200W	2,200W
<b>Wheel Diameter</b>	180 mm (7")	230 mm (9")
<b>No Load Speed (RPM)</b>	8,500	6,600
<b>Vibration Level</b>	Surface Grinding : 8.0 m/s <sup>2</sup> Disc Sanding: 2.5 m/s <sup>2</sup>	Surface Grinding: 5.5 m/s <sup>2</sup> Disc Sanding: 2.5 m/s <sup>2</sup> or less
<b>Sound Pressure Level</b>	89 dB(A)	89 dB(A)
<b>Sound Power Level</b>	100 dB(A)	100 dB(A)
<b>Dimensions (L x W x H)</b>	473x200x140 mm (18-5/8"x7-7/8"x5-1/2")	473x249x140 mm (18-5/8"x9-3/4"x5-1/2")
<b>Net weight</b>	5.56 kg (12.26 lbs)	5.76 kg (12.7 lbs)
<b>Power supply cord</b>	2.5 m (8.2 ft)	2.5 m (8.2 ft)

**Outstanding durability**

- Increased heat resistance.
- Superior anti-dust structure.
- Machined bevel gear for strength.
- Soft grip for more comfort and control.
- Gear housing can be positioned at every 90 degrees.

**Standard Equipment:** Lock Nut Wrench, Grip.

- OPE
- JOBBSITE TOOLS
- SPECIALTY TOOLS
- HAND TOOLS / COMBINATION SET
- TOOL HOLDERS AND POUCHES / MAKPAC SYSTEM



**2,200W** MOTOR

**Angle Grinder - 2,200W (Large Trigger Switch)**



	<b>GA7062 180mm (7")</b>	<b>GA9062 230mm (9")</b>
<b>Continuous rating input</b>	2,200W	2,200W
<b>Wheel Diameter</b>	180 mm (7")	230 mm (9")
<b>No Load Speed (RPM)</b>	8,500	6,600
<b>Vibration Level</b>	Surface Grinding : 7.5 m/s <sup>2</sup> Disc Sanding : 2.5 m/s <sup>2</sup>	Surface Grinding : 6.0 m/s <sup>2</sup> Disc Sanding : 2.5 m/s <sup>2</sup> or less
<b>Sound Pressure Level</b>	91 dB(A)	91 dB(A)
<b>Sound Power Level</b>	102 dB(A)	102 dB(A)
<b>Dimensions (L x W x H)</b>	450x200x144 mm (17-3/4"x7-7/8"x5-5/8")	450x250x144 mm (17-3/4"x9-7/8"x5-5/8")
<b>Net weight</b>	5.51 kg (12.2 lbs)	5.61 kg (12.4 lbs)
<b>Power supply cord</b>	2.5 m (8.2 ft.)	2.5 m (8.2 ft.)

**High durability and Superior usability D shape Handle grinders.**

- Improvement of armature, commutator, carbon brush life, switch section, shaft lock pin, new brush holder and rigid motor housing.
- D-shape Handle protects user's hand from materials
- Easy to grip handle with anti-slip shape and comfortable side grip for better balance
- Compact and light weight

**Standard Equipment:** Lock Nut Wrench, Grip.





### Angle Grinder - 2,200W (Large Trigger Switch) (SJS II)

GA7063 180mm (7")
 GA9063 230mm (9")





<b>Continuous rating input</b>	2,200W	2,200W
<b>Wheel Diameter</b>	180 mm (7")	230 mm (9")
<b>No Load Speed (RPM)</b>	8,500	6,600
<b>Vibration Level</b>	Surface Grinding: 6.5 m/s <sup>2</sup>	Surface Grinding with : 5.5 m/s <sup>2</sup>
	Disc Sanding : 2.5 m/s <sup>2</sup> or less	Disc Sanding : 2.5 m/s <sup>2</sup> or less
<b>Sound Pressure Level</b>	91 dB(A)	91 dB(A)
<b>Sound Power Level</b>	102 dB(A)	102 dB(A)
<b>Dimensions</b>	450x200x145 mm	450x250x145 mm
<b>(L x W x H)</b>	(17-3/4"x7-7/8"x5-3/4")	(17-3/4"x9-7/8"x5-3/4")
<b>Net weight</b>	5.64 - kg (12.4 lbs)	5.75 kg (12.7 lbs)
<b>Power supply cord</b>	2.5 m (8.2 ft.)	2.5 m (8.2 ft.)

**High durability and Superior usability D shape Handle grinders with "Super Joint System II" developed for effective vibration absorption**

- Improvement of armature, commutator, carbon brush life, switch section, shaft lock pin, new brush holder and rigid motor housing.
- D-shape Handle protects user's hand from materials
- Easy to grip handle with anti-slip shape and comfortable side grip for better balance
- Compact and light weight

**Standard Equipment:** Lock Nut Wrench, Grip.

DRILLING / FIXING

CONCRETE DRILLING / DEMOLITION

MIXING / STIRRING

CUTTING (CONCRETE / METAL)

GRINDING

SANDING / POLISHING

SAWING

MULTI-TOOL

ROUTERS / PLANERS

NAILERS / STAPLERS

HEAT GUN / LASER

CLEANING

OPE

JOBSITE TOOLS

SPECIALTY TOOLS

HAND TOOLS / COMBINATION SET

TOOL HOLDERS AND POUCHES / MAKPAC SYSTEM



### Angle Grinder - 2,200W - 2,400W (Large Trigger Switch)

GA7030 180mm (7")
 GA9030 230mm (9")





<b>Continuous rating input</b>	2,400W (220V) / 2,200W (127V)	2,400W (220V) / 2,200W (127V)
<b>Wheel Diameter</b>	180 mm (7")	230 mm (9")
<b>No Load Speed (RPM)</b>	8,500	6,600
<b>Vibration Level</b>	Surface Grinding: 6.5 m/s <sup>2</sup>	Surface Grinding: 6.5 m/s <sup>2</sup>
	Disc Sanding: 2.5 m/s <sup>2</sup>	Disc Sanding: 2.5 m/s <sup>2</sup> or less
<b>Sound Pressure Level</b>	89 dB(A)	90 dB(A)
<b>Sound Power Level</b>	100 dB(A)	101 dB(A)
<b>Dimensions</b>	511x200x140 mm	503x250x140 mm
<b>(L x W x H)</b>	(20-1/8"x7-7/8"x5-1/2")	(19-3/4"x9-7/8"x5-1/2")
<b>Net weight</b>	6.06 kg (13.36 lbs)	6.26 kg (13.8 lbs)
<b>Power supply cord</b>	2.5 m (8.2 ft)	2.5 m (8.2 ft)

**Heavy duty motor with 2,200W - 2,400W continuous rating Input.**

- Outstanding durability. Superior anti-dust Structure, Machined bevel gear. Increased heat resistance.
- Low vibration rear handle with soft grip for more comfort and control.
- Rotatable rear handle can be positioned to suit most cutting & grinding operations.
- Protects work piece from scratches large rubber tool rest.
- Gear housing can be positioned at every 90 degrees.

**Standard Equipment:** Lock Nut Wrench, Grip.

SANDING / POLISHING

SAWING

MULTI-TOOL

ROUTERS / PLANERS

NAILERS / STAPLERS

HEAT GUN / LASER

CLEANING

OPE

JOBSITE TOOLS

SPECIALTY TOOLS

HAND TOOLS / COMBINATION SET

TOOL HOLDERS AND POUCHES / MAKPAC SYSTEM



### Angle Grinder - 2,600W (Large Trigger Switch)

GA7040S 180mm (7")
 GA9040S 230mm (9")





<b>Continuous rating input</b>	2,600W	2,600W
<b>Wheel Diameter</b>	180 mm (7")	230 mm (9")
<b>No Load Speed (RPM)</b>	8,500	6,600
<b>Vibration Level</b>	Surface Grinding: 7.5 m/s <sup>2</sup>	Surface Grinding: 5.5 m/s <sup>2</sup>
	Disc Sanding: 2.5 m/s <sup>2</sup>	Disc Sanding: 2.5 m/s <sup>2</sup> or less
<b>Sound Pressure Level</b>	90 dB(A)	90 dB(A)
<b>Sound Power Level</b>	101 dB(A)	101 dB(A)
<b>Dimensions</b>	511x200x140 mm	503x250x140 mm
<b>(L x W x H)</b>	(20-1/8"x7-7/8"x5-1/2")	(19-3/4"x9-7/8"x5-1/2")
<b>Net weight</b>	6.45 kg (14.2 lbs)	6.65 - 8.94 kg (14.7 lbs)
<b>Power supply cord</b>	2.5 m (8.2 ft)	2.5 m (8.2 ft)

**Heavy duty motor with 2,600W continuous rating Input.**

- Outstanding durability. Superior anti-dust Structure, Machined bevel gear. Increased heat resistance.
- Low vibration rear handle with soft grip for more comfort and control.
- Rotatable rear handle can be positioned to suit most cutting & grinding operations.
- Protects work piece from scratches large rubber tool rest.
- Gear housing can be positioned at every 90 degrees.

**Standard Equipment:** Lock Nut Wrench, Grip.

SANDING / POLISHING

SAWING

MULTI-TOOL

ROUTERS / PLANERS

NAILERS / STAPLERS

HEAT GUN / LASER

CLEANING

OPE

JOBSITE TOOLS

SPECIALTY TOOLS

HAND TOOLS / COMBINATION SET

TOOL HOLDERS AND POUCHES / MAKPAC SYSTEM

- DRILLING / FIXING
- CONCRETE DRILLING / DEMOLITION
- MIXING / STIRRING
- CUTTING (CONCRETE / METAL)
- GRINDING**
- SANDING / POLISHING
- SAWING
- MULTI-TOOL
- ROUTERS / PLANERS
- NAILERS / STAPLERS
- HEAT GUN / LASER
- CLEANING
- OPE
- JOBSITE TOOLS
- SPECIALTY TOOLS
- HAND TOOLS / COMBINATION SET
- TOOL HOLDERS AND POUCHES / MAKPAC SYSTEM

**NEW**

**2,700W MOTOR**  
220V - 240V

**2,400W MOTOR**  
127V

### Angle Grinder - 2,700W (Large Trigger Switch) -AC-

	<b>GA7080</b> 180mm (7")	<b>GA9080</b> 230mm (9")
<b>Continuous rating Input</b>	220 - 240V : 2,700W 127V : 2,200 W	220 - 240V : 2,700W 127V : 2,200 W
<b>Wheel Diameter</b>	180 mm (7")	230 mm (9")
<b>Hole Diameter</b>	22.23 mm	22.23 mm
<b>No Load Speed (RPM)</b>	8,500	6,600
<b>Dimensions (L x W x H)</b>	509 x 200 x 144 mm	509 x 250 x 144 mm
<b>Net weight</b>	6.3 - 6.8 kg	6.5 - 8.6 kg
<b>Power supply cord</b>	2.5 m	2.5 m

**Heavy duty motor with 2,700W continuous rating Input**

- Provide excellent maneuverability and product balance in a wide range of work postures
- Anti-restart function prevents accidental start-up of the grinder
- Re-designed Shaft lock enables to press the button from a slant angle for easier wheel changes

**Standard Equipment:** Lock Nut Wrench, Grip.

**NEW**

**2,800W MOTOR**  
220V - 240V

**2,200W MOTOR**  
127V

**AFT (BRAKE)**

### Angle Grinder - 2800W (Large Trigger Switch) -AC-

	<b>GA7070</b> 180mm (7")	<b>GA9070</b> 230mm (9")
<b>Continuous rating Input</b>	220 - 240V : 2,800 W 127V : 2,200 W	220 - 240V : 2,800 W 127V : 2,200 W
<b>Wheel Diameter</b>	180 mm (7")	230 mm (9")
<b>Hole Diameter</b>	22.23 mm (7/8")	22.23 mm (7/8")
<b>No Load Speed (RPM)</b>	8,500	6,600
<b>Dimensions (L x W x H)</b>	506 x 200 x 146 mm	506 x 250 x 146 mm
<b>Net weight</b>	6.1 - 6.6 kg	6.3 - 8.5 kg
<b>Power supply cord</b>	2.5 m	2.5 m

**Heavy duty motor with 2,800W continuous rating Input**

- MECHANICAL BRAKE (provide minimum down time between each runs)
- AFT FUNCTION protects the machine by turning off the motor if the rotation is suddenly forced to stop
- CONSTANT SPEED CONTROL automatically applies additional power to the motor to maintain speed under load
- Provide excellent maneuverability and product balance in a wide range of work postures
- Anti-restart function prevents accidental start-up of the grinder
- Re-designed Shaft lock enables to press the button from a slant angle for easier wheel changes

**Standard Equipment:** Lock Nut Wrench, Grip.



**DGD800** 18V | **LXT**

**Cordless Die Grinder**



**Now free from cord for easy job site portability.**

- Long-nose type.
- Solid aluminum bearing box.
- Vent slots designed to direct exhaust air away from operator.
- Easy-to-grip motor housing with small circumference.



<b>Capacity</b>	Collet : 3mm - 8mm
<b>Wheel diameter</b>	38mm (1-1/2")
<b>No load speed (rpm)</b>	26,000
<b>Dimensions (L x W x H)</b>	402x82x118mm (15-3/4" x 3-1/4" x 4-5/8")
<b>Net weight</b>	2.0kg (4.4lbs)



**Standard Equipment:** Wrench x 2pcs

**AVAILABLE VARIANTS**

5.0Ah	3.0Ah	"Z" VARIANT
-	-	<b>DGD800 Z</b> TOOL ONLY (DOES NOT INCLUDE BATTERY / CHARGER OR CARRY CASE)

**GD0603 6mm (1/4")**

**Die Grinder**

**Compact design with small diameter barrel**

- Power and speed in a compact size, and features motor-protection features for longer tool life
- Contoured neck grip provides a secondary hand position for increased maneuverability
- Round-shaped collet nut is designed to help prevent damage/scratches to workpiece
- Can be gripped close to the stone for steadier work.



<b>Continuous rating Input</b>	240W
<b>Collet Capacity</b>	6 mm or 1/4"
<b>Max Wheel Diameter</b>	19 mm (3/4")
<b>No Load Speed (RPM)</b>	28,000
<b>Diameter of grip</b>	65 mm
<b>Circumference of Grip Portion</b>	203 mm
<b>Dimensions (L x W x H)</b>	289 x 64 x 67 mm
<b>Net weight</b>	0.98 kg
<b>Power supply cord</b>	2.5 m

**GD0600 6mm (1/4")**

**Die Grinder**



**Small-circumference housing for easy handling.**

- Anti-slip rubber cover for easy handling.
- Round-shaped collet nut reduces the possibility of damages/ scratches to workpiece.
- Vent slots designed to direct the exhaust air stream towards the opposite side of the operator.
- High heat resistance.
- Operate paddle type switch.



<b>Continuous rating Input</b>	400W
<b>Capacity</b>	Collet : 3,6mm or 1/8", 1/4"
<b>Wheel dia.</b>	38mm (2-1/2")
<b>No load speed</b>	25,000rpm
<b>Dimensions</b>	358mm x 82mm x 82mm
<b>(L x W x H)</b>	(14-1/8" x 3-1/4" x 3-1/4")
<b>Net weight</b>	1.7kg (3.7lbs)
<b>Power supply cord</b>	2.5m (8.2ft)

**GD0602 6mm (1/4")**

**Die Grinder**



**Compact body with short nose.**

- Anti-slip rubber cover for easy handling.
- Round-shaped collet nut reduces the possibility of damages/scratches to the workpiece.
- Switch lever conveniently located for one hand operation.
- Vent slots designed to direct the exhaust air stream towards the opposite side of the operator.



<b>Continuous rating Input</b>	400W
<b>Capacity</b>	Collet : 6mm or 1/4"
<b>Wheel dia.</b>	38mm (1-1/2")
<b>No load speed (rpm)</b>	25,000
<b>Dimensions</b>	264 x 82 x 82mm
<b>(L x W x H)</b>	(10-3/8" x 3-1/4" x 3-1/4")
<b>Net weight</b>	1.4kg (3.2lbs)
<b>Power supply cord</b>	2.5m (8.2ft)

- DRILLING / FIXING
- CONCRETE DRILLING / DEMOLITION
- MIXING / STIRRING
- CUTTING (CONCRETE / METAL)
- GRINDING**
- SANDING / POLISHING
- SAWING
- MULTI-TOOL
- ROUTERS / PLANERS
- NAILERS / STAPLERS
- HEAT GUN / LASER
- CLEANING
- OPE
- JOBSITE TOOLS
- SPECIALTY TOOLS
- HAND TOOLS / COMBINATION SET
- TOOL HOLDERS AND POUCHES / MAKPAC SYSTEM

DRILLING / FIXING

CONCRETE DRILLING / DEMOLITION

MIXING / STIRRING

CUTTING (CONCRETE / METAL)

**GRINDING**

SANDING / POLISHING

SAWING

MULTI-TOOL

**GD0800C** 8mm (1/4")

**Die Grinder**

**High speed for mounted points - Max wheel point 25mm**



**High-speed die grinder with max. 8mm collet capacity.**

- Ergonomically designed slim body for grinding in tight spots.
- Super Joint System absorbs shock caused by accidental wheel lock and protects gears.
- Internal labyrinth construction seals motor and bearings from contamination.

**Standard Equipment:** Wrench (2pcs)

**GD0810C** 8mm (1/4")

**Die Grinder**

**Low speed for flap discs - Max wheel point 50mm**



**Low-speed die grinder with max. 8mm collet capacity.**

- Ergonomically designed slim body for grinding in tight spots.
- Super Joint System absorbs shock caused by accidental wheel lock and protects gears.
- Internal labyrinth construction seals motor and bearings from contamination.
- Ideal for grinding internal surfaces, removing paint etc. using with flap wheel discs.

**Standard Equipment:** Wrench (2pcs)

ROUTERS / PLANERS

NAILERS / STAPLERS

HEAT GUN / LASER

CLEANING

OPE

JOBSITE TOOLS

SPECIALTY TOOLS

HAND TOOLS / COMBINATION SET

TOOL HOLDERS AND POUCHES / MAKPAC SYSTEM

**GD0801C** 8mm (1/4") (Paddle switch)

**Die Grinder**

**Easy-to-operate paddle type on/off switch**

- Ergonomically designed slim body for grinding in tight spots.
- Super Joint System absorbs shock caused by accidental wheel lock and protects gears.
- Side handle can be attached.

**Standard Equipment:** Wrench (2pcs)

**GD0811C** 8mm (1/4") (Paddle switch)

**Die Grinder**

**Easy-to-operate paddle type on/off switch**

- Ergonomically designed slim body for grinding in tight spots.
- Super Joint System absorbs shock caused by accidental wheel lock and protects gears.
- Internal labyrinth construction seals motor and bearings from contamination.
- Ideal for grinding internal surfaces, removing paint etc. using with flap wheel discs.

**Standard Equipment:** Wrench (2pcs)

# GS5000 125mm (5") // GS6000 150mm (6") - Straight Grinder

Ergonomically design handle and barrel for added extra maneuverability

Ergonomically design barrel with rubberized cover



### Improved durability of gears

about two times as tough as the current by;

- (1) Change of the grease
- (2) Modification on the inside of Gear housing for grease to stay on Gears teeth.



Photo: GS6000

Rubberized soft grip provides comfortable and sure grip.

Large type trigger switch



Auto Cut-out Carbon Brush

DRILLING / FIXING

CONCRETE DRILLING / DEMOLITION

MIXING / STIRRING

CUTTING (CONCRETE / METAL)

GRINDING

SANDING / POLISHING

SAWING

MULTI-TOOL

ROUTERS / PLANERS

NAILERS / STAPLERS

HEAT GUN / LASER

CLEANING

OPE

JOBSITE TOOLS

SPECIALTY TOOLS

HAND TOOLS / COMBINATION SET

TOOL HOLDERS AND POUCHES / MAKPAC SYSTEM

## GS5000 125mm (5")



### Straight Grinder



#### Double insulated 125mm straight grinder

Light weight with large soft grip reduce operator's fatigue. Suitable RPM and design for a long time heavy grinding work.



Continuous rating input	750W
Wheel diameter	125mm (5")
Hole dia.	12.7,20mm (1/2,13/16")
No load speed (rpm)	5,600
Dimensions (L x W x H)	590x189x116mm (23-1/4"x7-7/16"x4-9/16")
Net weight	5.0kg (11.1lbs)
Power supply cord	2.5m (8.2ft)

Standard Equipment: Wrench (2pcs)

## GS6000 150mm (6")



### Straight Grinder



#### Double insulated 150mm straight grinder

Light weight with large soft grip reduce operator's fatigue. Suitable RPM and design for a long time heavy grinding work.



Continuous rating input	750W
Wheel diameter	150mm (6")
Hole dia.	12.7,20mm (1/2,13/16")
No load speed (rpm)	5,600
Dimensions (L x W x H)	590x216x130mm (23-1/4"x8-1/2"x5-1/8")
Net weight	5.2kg (11.5lbs)
Power supply cord	2.5m (8.2ft)

Standard Equipment: Wrench (2pcs)

- DRILLING / FIXING
- CONCRETE DRILLING / DEMOLITION
- MIXING / STIRRING
- CUTTING (CONCRETE / METAL)
- GRINDING**
- SANDING / POLISHING
- SAWING
- MULTI-TOOL
- ROUTERS / PLANERS
- NAILERS / STAPLERS
- HEAT GUN / LASER
- CLEANING
- OPE
- JOBSITE TOOLS
- SPECIALTY TOOLS
- HAND TOOLS / COMBINATION SET
- TOOL HOLDERS AND POUCHES / MAKPAC SYSTEM

**9105** 125mm (5")

**Straight Grinder**

**A well proven, mighty performance in grinding of castings and welds.**

153

<b>Continuous rating Input</b>	750W
<b>Max. wheel size</b>	125mm x 19mm (5" x 3/4")
<b>Hole dia.</b>	12.7mm (1/2")
<b>No load speed</b>	4,800rpm
<b>Overall length</b>	550mm (21-5/8")
<b>Net weight</b>	5.1kg (11.1lbs)
<b>Power supply cord</b>	2.5m (8.2ft)

**Standard Equipment:** Wrench.

**GB602** 150mm (6")

**Bench Grinder**

**Steady tool maintenance from this light, yet stable performer.**

- Cosmetic new design.
- The safety shields and spark deflectors are adjustable for operator's convenience.

<b>Continuous rating Input</b>	250W
<b>Wheel diameter</b>	150mm x 16mm
<b>Hole dia.</b>	12.7mm (1/2")
<b>H.P.</b>	1/3
<b>No load speed (rpm)</b>	2,850 (50Hz) / 3,450 (60Hz)
<b>Dimensions</b>	375 x 205 x 286mm
<b>(L x W x H)</b>	(14-49/64" x 8" x 11-17/64")
<b>Net weight</b>	9.2kg (20.3lbs)

**Standard Equipment:** Eye Shields

**GB800** 205mm (8")

**Bench Grinder**

**With a large 540W motor, GB800 is perfect for light industrial applications.**

- Comes with protective shields and tool rests.

<b>Continuous rating input</b>	540 W
<b>Max. wheel size</b>	205 mm x 25 mm (8" x 1")
<b>Distance between wheels</b>	345 mm (13-9/16")
<b>H.P.</b>	3/4
<b>No load speed</b>	2,850 rpm
<b>Overall length</b>	455 mm (18")
<b>Net weight</b>	18.5 kg (40.8 lbs)

**Standard Equipment:** Eye Shields

**GB801** 205mm (8")

**Bench Grinder**

**Steady tool maintenance from this light, yet stable performer.**

- Cosmetic new design.
- Balance weight installed.
- Integral work lights automatically turn on to illuminate the work area for more accurate grinding and polishing .

<b>Continuous rating Input</b>	550W
<b>Wheel diameter</b>	205mm x 19mm
<b>Hole dia.</b>	15.88mm (5/8")
<b>H.P.</b>	3/4
<b>No load speed (rpm)</b>	2,850 (50Hz) / 3,450 (60Hz)
<b>Dimensions</b>	395 x 265 x 333mm
<b>(L x W x H)</b>	(15-9/16" x 10-7/16" x 13-7/64")
<b>Net weight</b>	19.8kg (43.6lbs)

**Standard Equipment:** Eye Shields

# Concrete Planer



## PC5010C 125mm

### Concrete Planer



#### Engineered for low vibration and fast material removal

- SJSII provides a drive mechanism that is engineered to reduce vibration for increased comfort
- Compact and lightweight design
- Removable front cover enables user plane flush to walls or corners.
- Anti-restart function.



Continuous rating Input	1,400W
Wheel Diameter	125 mm (5")
Hole Diameter	22.23 mm
No Load Speed (RPM)	4,000 - 9,000
Dimensions (L x W x H)	350 x 231 x 179 mm
Net weight	2.5 - 3.6 kg
Power supply cord	4.0 m

Standard Equipment: Lock Nut Wrench

## PC5000C 125mm

### Concrete Planer



#### Most suitable for planing concrete.

- Capable of planing flush to corners.
- Powerful 1,400W motor provides efficient planing operation.
- Anti-restart function is provided.
- Electrical current limiter protects motor from overload.



Continuous rating Input	1,400W
Wheel dia.	125mm (5")
Hole dia.	22.23mm (7/8")
No load speed (rpm)	10,000
Dimensions	437 x 235 x 195mm
(L x W x H)	(17-1/8" x 9-1/4" x 7-5/8")
Net weight	4.0kg (8.9lbs)
Power supply cord	5.0m (16.4ft)

Standard Equipment: Lock Nut Wrench, Hex Wrench, Dust Bag Assembly

## PC5001C 125mm

### Concrete Planer



#### Most suitable for planing concrete.

- Front roller adjusts planing depth. / Auxiliary base for smoother planing.
- Capable of planing flush to corners.
- Powerful 1,400W motor provides efficient planing operation.
- Anti-restart function is provided.
- Electrical current limiter protects motor from overload.



Continuous rating Input	1,400W
Wheel dia.	125mm (5")
Hole dia.	22.23mm (7/8")
No load speed (rpm)	10,000
Dimensions	479 x 182 x 195mm
(L x W x H)	(18-13/16" x 7-1/8" x 7-5/8")
Net weight	5.1kg (11.2lbs)
Power supply cord	5.0m (16.4ft)

Standard Equipment: Lock Nut Wrench, Hex Wrench, Dust Bag Assembly

- DRILLING / FIXING
- CONCRETE DRILLING / DEMOLITION
- MIXING / STIRRING
- CUTTING (CONCRETE / METAL)
- GRINDING
- SANDING / POLISHING
- SAWING
- MULTI-TOOL
- ROUTERS / PLANERS
- NAILERS / STAPLERS
- HEAT GUN / LASER
- CLEANING
- OPE
- JOB SITE TOOLS
- SPECIALTY TOOLS
- HAND TOOLS / COMBINATION SET
- TOOL HOLDERS AND POUCHES / MAKPAC SYSTEM

- DRILLING / FIXING
- CONCRETE DRILLING / DEMOLITION
- MIXING / STIRRING
- CUTTING (CONCRETE / METAL)
- GRINDING
- SANDING / POLISHING
- SAWING
- MULTI-TOOL
- ROUTERS / PLANERS
- NAILERS / STAPLERS
- HEAT GUN / LASER
- CLEANING
- OPE
- JOBSITE TOOLS
- SPECIALTY TOOLS
- HAND TOOLS / COMBINATION SET
- TOOL HOLDERS AND POUCHES / MAKPAC SYSTEM

## Diamond Wheel Range

The Makita diamond wheel series offers three types of wheel grades to meet user needs

Premium Range: This yields the highest performance in both cutting speed and durability.



Professional Range: This achieves an optimum balance between performance and price.

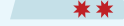

Entry Level Range: This has the attraction of a reasonable price tag.



## Cosmos premium range diamond wheel features



- Premium range diamond wheels for demanding needs
- High Performance and Long Life
- Smooth, Stable, Clean and Fast cut

Our premium diamond wheels "The Cosmos System" (Nebula and Comet) brings a universal approach to blade selection. Advanced segment bonds allow for premium performance across a wider range of materials. The Cosmos premium range of diamond wheels have been carefully crafted to best meet the demanding needs of professional users. Cosmos system feature our unique diamond wheel technology, which helps to provide outstanding cutting performance. As such, the wheels are able to cut faster and last longer than traditional ones.

### LASER WELDED

To improve productivity and speed of cut, the wheel segments have been laser welded onto the body to give additional strength and durability when cutting.

### V-SHAPED SEGMENTS

The unique segmented design is engineered to improve acceleration into cuts during the initial stage, reduce friction and significantly improve cooling.

### COOLING HOLES

Keeps the diamond wheel cool during operation helps to prevent expansion of the wheel and ensure a smooth cutting action – reducing fatigue for the operator and potential damage to the power tool. The presence of holes in the wheel also improves visibility for the user when cutting.

### FIXED METAL BOSS

The reinforced center boss uses a soft metal inner core to dampen vibration through the wheel, lowering running noise and guaranteeing an unrivalled quality and ease of cut for the operator. A stable wheel cuts cleaner and quicker removing less material and extending wheel life-time.

### 3DDG TECHNOLOGY

**For faster cutting and longer tool life.** Unparalleled performance and speed with 3DDG technology. An advance technology that allows to manufacture segments with diamond grits evenly placed within the segment in a 3 dimensional pattern

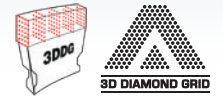

## Materials

1	2	3	4	5	6	7	8	9
Granite	Concrete	Re-inforced Concrete	Marble	Brick	Asphalt	Tiles	Fibreboard \ Glassfibre	Porcelain Tiles
Hard concrete	Block		Unglazed Tile	Aggregate Block				
Gneiss	U-shaped Groove			French Tile				
Smoothable Engineering	Sidewalk Block							
Carbonaceous Shale	Cemented Tile							
Sidewalk Slate								
Engineering Block and Class 2								

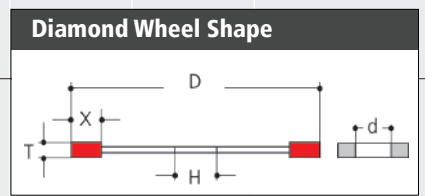

MATERIAL: ● SPECIALLY SUITABLE | ○ SUITABLE



## Segmented rim

Most commonly used. Blade has slits and a layer of diamond is sintered on the edges. Cuts faster than continuous rim type and maintains average cutting surface

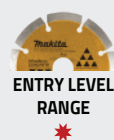

D	T	X	H	d	COLOUR	MATERIAL: ● SPECIALLY SUITABLE   ○ SUITABLE									DRY/WET	SUITABLE FOR	PART NO.
						1	2	3	4	5	6	7	8	9			
105	2.0	7	20	16	Gold		●		●	○	○				DRY	100mm (Gr), 110mm (Cu)	D-05197
115	1.8	7	22.23	-	Gold	○	●		○	○				DRY	115mm Grinder	D-44270	
180	2.2	7	22.23	-	Gold	○	●		○	○				DRY	180mm Grinder	D-44286	
230	2.4	7	22.23	-	Gold	○	●		○	○				DRY	230mm Grinder	D-44292	



D	T	X	H	d	COLOUR	MATERIAL: ● SPECIALLY SUITABLE   ○ SUITABLE									DRY/WET	SUITABLE FOR	PART NO.
						1	2	3	4	5	6	7	8	9			
105	1.8	7.5	20	16	Gold		●		●	○	○			DRY	100mm (Gr), 110mm (Cu)	A-87149	
105	1.8	7	20	16	Gold		●		●	○	○			DRY	100mm (Gr), 110mm (Cu)	A-84187	
110	1.8	6	20	-	Gold		●		●	○	○			DRY	115mm Cutter	A-05022	
115	1.9	7	22.23	-	Gold		●		●	○	○			DRY	115mm Grinder	A-84109	
125	1.9	7	22.23	20	Gold		●		●	○	○			DRY	125mm Grinder, Cutter	A-84115	
125	2.0	7	22.23	20	Gold		●		●	○	○			DRY	125mm Grinder, Cutter	A-88901	
150	2.1	7	22.23	-	Gold		●		●	○	○			DRY	150mm Grinder	B-06432	
180	2.0	7	25.4	22.23	Gold		●		●	○	○			DRY	180mm Grinder, Cutter	A-87909	
180	2.3	7	25.4	22.23	Gold		●		●	○	○			DRY	180mm Grinder, Cutter	A-84121	
230	2.5	7	22.23	-	Gold		●		●	○	○			DRY	230mm Grinder	A-84137	



Nebula diamond wheel offers very good quality, affordable wheels for those who want something more reliable than a single-use solution.

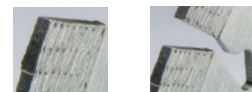

LASER WELDED V SHAPE SEGMENT

D	T	X	H	d	COLOUR	MATERIAL: ● SPECIALLY SUITABLE   ○ SUITABLE									DRY/WET	SUITABLE FOR	PART NO.
						1	2	3	4	5	6	7	8	9			
115	2.0	10	22.23	-	Gold	○	●	○		○	○			WET / DRY	115mm Grinder	B-53986	
180	2.0	10	22.23	-	Gold	○	●	○		○	○			WET / DRY	180mm Grinder	B-54019	
230	2.4	10	22.23	-	Gold	○	●	○		○	○			WET / DRY	230mm Grinder	B-54025	



With Comet range, cutting concrete just got easier designed with Makita's 3DDG technology for unparalleled performance and speed. The Comet is a universal wheel, aimed at applications where superior quality is required.



LASER WELDED V SHAPE SEGMENT COOLING HOLES

D	T	X	H	d	COLOUR	MATERIAL: ● SPECIALLY SUITABLE   ○ SUITABLE									DRY/WET	SUITABLE FOR	PART NO.
						1	2	3	4	5	6	7	8	9			
115	2.0	10	22.23	-	Blue	○	●	●		●	○			WET / DRY	115mm Grinder	B-12762	
180	2.0	10	22.23	-	Blue	○	●	●		●	○			WET / DRY	180mm Grinder	B-27193	
230	2.4	10	22.23	-	Blue	○	●	●		●	○			WET / DRY	230mm Grinder	B-12784	



D	T	X	H	d	COLOUR	MATERIAL: ● SPECIALLY SUITABLE   ○ SUITABLE									DRY/WET	SUITABLE FOR	PART NO.
						1	2	3	4	5	6	7	8	9			
105	1.7	7	20	16	Silver	●	●		●	○	○			DRY	100mm Grinder, 110mm Cutter	A-84090	
115	1.8	7	22.23	-	Silver	●	●		●	○	○			DRY	115mm Grinder	A-84006	
125	2.0	7	22.23	20	Silver	●	●		●	○	○			DRY	125mm Grinder	A-84012	
180	2.0	7	25.4	22.23	Silver	●	●		●	○	○			DRY	180mm Grinder, Cutter	A-84028	
230	2.2	7	22.23	-	Silver	●	●		●	○	○			DRY	230mm Grinder	A-84408	

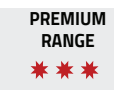

D	T	X	H	d	COLOUR	MATERIAL: ● SPECIALLY SUITABLE   ○ SUITABLE									DRY/WET	SUITABLE FOR	PART NO.
						1	2	3	4	5	6	7	8	9			
125	1.9	7	22.23	20	Blue	●	●		●	●				DRY	125mm Grinder, Cutter	A-01236	

CONCRETE

GRANITE

## Segmented wave rim

Similar to segmented wheels but with many notches (Wave) in each segment. These notches ensure: Fast cutting with less resistance | Smooth debris removal | Less loading on wheel



D	T	X	H	d	COLOUR	MATERIAL: ● SPECIALLY SUITABLE   ○ SUITABLE									DRY/WET	SUITABLE FOR	PART NO.
						1	2	3	4	5	6	7	8	9			
105	2.0	7.5	20	16	Gold		●		●	○	○			DRY	100mm Grinder, 110mm Cutter	B-03028	
115	2.0	7.5	22.23	-	Blue		●		●	○	○			DRY	115mm Grinder	A-80422	
125	2.0	7.5	22.23	-	Blue		●		●	○	○			DRY	125mm Grinder	A-80438	
230	2.5	7.5	22.23	-	Blue		●		●	○	○			DRY	230mm Grinder	A-80173	

CONCRETE

DRILLING / FIXING

CONCRETE DRILLING / DEMOLITION

MIXING / STIRRING

CUTTING (CONCRETE / METAL)

GRINDING

SANDING / POLISHING

SAWING

MULTI-TOOL

ROUTERS / PLANERS

NAILERS / STAPLERS

HEAT GUN / LASER

CLEANING

OPE

JBSITE TOOLS

SPECIALTY TOOLS

HAND TOOLS / COMBINATION SET

TOOL HOLDERS AND POUCHES / MAKPAC SYSTEM

- DRILLING / FIXING
- CONCRETE DRILLING / DEMOLITION
- MIXING / STIRRING
- CUTTING (CONCRETE / METAL)
- GRINDING
- SANDING / POLISHING
- SAWING
- MULTI-TOOL
- ROUTERS / PLANERS
- NAILERS / STAPLERS
- HEAT GUN / LASER
- CLEANING
- OPE
- JOBSITE TOOLS
- SPECIALTY TOOLS
- HAND TOOLS / COMBINATION SET
- TOOL HOLDERS AND POUCHES / MAKPAC SYSTEM

## Corrugated rim

This wheel has notches around the Rim. Has a characteristic between Continuous Rim and Segmented Type. Has faster cutting like Segmented Type. At the same time, can attain cleaner surface like continuous rim without broken edges.



CONCRETE	ENTRY LEVEL RANGE	D	T	X	H	d	COLOUR	MATERIAL: <span style="color: red;">●</span> SPECIALLY SUITABLE   <span style="color: grey;">○</span> SUITABLE									DRY/WET	SUITABLE FOR	PART NO.
								1	2	3	4	5	6	7	8	9			
								105	2.0	7	20	16	Gold		●				
115	2.3	7	22.23	-	Gold		●		●	○							DRY	115mm Grinder	D-37596
180	2.9	7	22.23	-	Gold		●		●	○							DRY	180mm Grinder	D-37611
230	3.1	7	22.23	-	Gold		●		●	○							DRY	230mm Grinder	D-37627

CONCRETE	PROFESSIONAL RANGE	D	T	X	H	d	COLOUR	MATERIAL: <span style="color: red;">●</span> SPECIALLY SUITABLE   <span style="color: grey;">○</span> SUITABLE									DRY/WET	SUITABLE FOR	PART NO.
								1	2	3	4	5	6	7	8	9			
								115	2.0	7	22.23	-	Gold		●				
115	2.0	7	22.23	-	Gold		●		●								DRY	115mm Grinder	A-88939
125	2.1	7	22.23	20	Gold		●		●	○	○						DRY	125mm Grinder, Cutter	A-84159
180	2.3	7	25.4	22.23	Gold		●		●	○	○						DRY	180mm Grinder, Cutter	A-84165
230	2.6	7	22.23	-	Gold		●		●	○	○						DRY	230mm Grinder	A-84171
230	2.3	7	22.23	-	Silver		●		●	●	○						DRY	230mm Grinder	B-01806

GRANITE	PROFESSIONAL RANGE	D	T	X	H	d	COLOUR	MATERIAL: <span style="color: red;">●</span> SPECIALLY SUITABLE   <span style="color: grey;">○</span> SUITABLE									DRY/WET	SUITABLE FOR	PART NO.
								1	2	3	4	5	6	7	8	9			
								105	2.2	7	22.23	20	Blue	●	●				
105	2.0	7	20	16	Gold	●	●		●	○	○						DRY	100mm (Gr), 110mm (Cu)	A-84040
115	2.3	7	22.23	-	Gold	●	●		●	○	○	●					WET	110mm Cutter	B-02836
180	2.9	7	22.23	-	Gold	●	●		●	○	○						DRY	230mm Grinder	A-84084

The best wheel for high speed cutting speed in granite. Applicable for professional users including stone-masons. Can be used with reinforced concrete.

GRANITE	COMET PREMIUM RANGE	D	T	X	H	d	COLOUR	MATERIAL: <span style="color: red;">●</span> SPECIALLY SUITABLE   <span style="color: grey;">○</span> SUITABLE									DRY/WET	SUITABLE FOR	PART NO.
								1	2	3	4	5	6	7	8	9			
								115	2.4	7	22.23	-	Blue	●	●	●			
175	2.4	7	22.23	-	Blue	●	●	●	○	●							WET / DRY	180mm Grinder	B-13013
230	2.4	8	22.23	-	Blue	●	●	●	○	●							WET / DRY	230mm Grinder	B-13035

## Continuous rim

Has layer of diamond with uniform thickness around the entire rim. Can maintain clean surface even on crusty, brittle materials. Cuts with accuracy but not as fast as segment type wheel



TILES	PROFESSIONAL RANGE	D	T	X	H	d	COLOUR	MATERIAL: <span style="color: red;">●</span> SPECIALLY SUITABLE   <span style="color: grey;">○</span> SUITABLE									DRY/WET	SUITABLE FOR	PART NO.
								1	2	3	4	5	6	7	8	9			
								76	1.4	7	10		Purple						
80	0.8	3	15	-	Silver									●	●		WET	CC301D	792296-4
105	1.6	5	20	16	Gold					○	●						DRY	100mm (Gr), 110mm (Cu)	A-89012
115	1.6	5	22.23	-	Gold					○	●						WET	115mm Grinder	A-89028

CONCRETE / MARBLE / TILES	ENTRY LEVEL	D	T	X	H	d	COLOUR	MATERIAL: <span style="color: red;">●</span> SPECIALLY SUITABLE   <span style="color: grey;">○</span> SUITABLE									DRY/WET	SUITABLE FOR	PART NO.
								1	2	3	4	5	6	7	8	9			
								110	1.6	5	20		Gold		●				

CONCRETE / MARBLE / TILES	PROFESSIONAL RANGE	D	T	X	H	d	COLOUR	MATERIAL: <span style="color: red;">●</span> SPECIALLY SUITABLE   <span style="color: grey;">○</span> SUITABLE									DRY/WET	SUITABLE FOR	PART NO.
								1	2	3	4	5	6	7	8	9			
								110	1.5	4	20		Gold	○	●				
110	1.5	4	20		Gold	○	●		●	○	○	●					WET	110mm Cutter	A-07185
180	1.85	4	25		Gold	○	●		●	○	○	●					WET	180mm Cutter	A-80117
180	1.85	4	25.4		Gold	○	●		●	○	○	●					WET	180mm Cutter	A-87161

## Electro plated rim

Diamonds are electrodeposited and has more exposure than bonded type. Cuts faster and more efficient.

Entry Level Range	D	T	X	H	d	COLOUR	MATERIAL: <span style="color:red">●</span> SPECIALLY SUITABLE   <span style="color:red">○</span> SUITABLE									DRY/WET	SUITABLE FOR	PART NO.
							1	2	3	4	5	6	7	8	9			
★	115	2.0	5	22.23	-	Silver				●						DRY	115mm Grinder	D-51085
	180	2.2	5	22.23	-	Silver				●						DRY	180mm Grinder	D-25030

MARBLES



**Supply fine, smooth cut in marble, glassfiber, GRP, cement fiberboard. Excellent for cutting GRP in boat yards, etc.**

Entry Level Range	D	T	X	H	d	COLOUR	MATERIAL: <span style="color:red">●</span> SPECIALLY SUITABLE   <span style="color:red">○</span> SUITABLE									DRY/WET	SUITABLE FOR	PART NO.
							1	2	3	4	5	6	7	8	9			
★ ★ ★ ★	115	1.5	5	22.23	-	Silver				●				●	WET / DRY	115mm Grinder	B-13172	
	175	1.5	5	22.23	-	Silver				●				●	WET / DRY	180mm Grinder	B-13203	
	230	1.5	5	22.23	-	Silver				●				●	WET / DRY	230mm Grinder	B-13219	

## Specialized Diamond Wheel - For Porcelain Tile

Continuous Rim - Widely used in all construction sites when laying tiles on floors and walls

Entry Level Range	D	T	X	H	Ring (mm)	COLOUR	MATERIAL: <span style="color:red">●</span> SPECIALLY SUITABLE   <span style="color:red">○</span> SUITABLE									DRY/WET	SUITABLE FOR	PART NO.
							1	2	3	4	5	6	7	8	9			
★	105	1.4	10	20	16	Purple									●	WET/DRY	100mm Grinders / 110mm cutters	D-76299
	115	1.4	10	22.23		Purple									●	DRY	115mm Grinder	D-65109

- HIGH SPEED AND GREAT PRECISION
- LESS TILE CHIPPING



Helps in heat radiation



Widely used in all construction sites when laying tiles on floors and walls

(used with 115mm Angle Grinders)

## Diamond Blade For X-Lock Grinders

- High Durability and High Quality
- Segmented Rim
- Suitable for Cordless X-lock Grinders Grinders (Also compatible with conventional angle grinders)
- Ideal for Concrete, Granite, Marble

X

LOCK



X-Lock fitting just one click to attach the accessories and easy removal just simply pull the lever



D	T	X	H	d	Color	For Material	For Model	Part No.
125				22.23	Green	Concrete, Granite, Marble	DGA519	E-02076
115				22.23	Green		DGA469	E-02060

- DRILLING / FIXING
- CONCRETE DRILLING / DEMOLITION
- MIXING / STIRRING
- CUTTING (CONCRETE / METAL)
- GRINDING
- SANDING / POLISHING
- SAWING
- MULTI-TOOL
- ROUTERS / PLANERS
- NAILERS / STAPLERS
- HEAT GUN / LASER
- CLEANING
- OPE
- JOB SITE TOOLS
- SPECIALTY TOOLS
- HAND TOOLS / COMBINATION SET
- TOOL HOLDERS AND POUCHES / MAKPAC SYSTEM

## Specialized Diamond Wheel - For Power Cutter

DRILLING / FIXING

CONCRETE DRILLING / DEMOLITION

MIXING / STIRRING

CUTTING (CONCRETE / METAL)

### A - Ideal for cordless power cutter

High Durability and High Quality diamond wheel with even pattern placement of diamond grits

- The grit arrangement provides sharp cutting edge constantly.
- Segmented and Wet & Dry

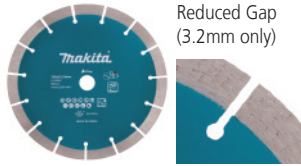

### B - DiaDuran - Long Last runners blades

DiaDuran blades have an enormous cutting capacity and thanks to a patented micro-fusion process have a much longer lifetime than diamond blades manufactured with conventional sintering techniques



### C- Quasar premium Cosmos diamond blade

- 3D Grid diamond blade
- Available with Stealth technology giving ultimate vibration and noise dampening for the best feel or with a reinforced centre and cooling holes for a fast and comfortable cut. Laser welded, wet and dry use.



GRINDING

SANDING / POLISHING

SAWING

MULTI-TOOL

ROUTERS / PLANERS

NAILERS / STAPLERS

HEAT GUN / LASER

CLEANING

OPE

JOBSITE TOOLS

SPECIALTY TOOLS

HAND TOOLS / COMBINATION SET

TOOL HOLDERS AND POUCHES / MAKPAC SYSTEM

D	T	X	H	D	COLOR	MATERIALS									FOR MODEL	TYPE	PART NO.	
						1	2	3	4	5	6	7	8	9				
230	3.2	13	22.23	-	Green	●	●		●	○						DCE090	A	E-02967
300	2.8	5	25.4	20	Silver	○	●		●	●						EK6100, EK7650H	-	A-86773
305	2.8	6.5	25.4	20	Silver	○	●		●	●						EK6100, EK7650H	-	A-89349
305	3.0	7.5	30	*	Blue		●		●	●	○					EK6100 / 4112HS, EK7650H	-	A-02490
350	3.2	5	25.4	20	Silver	○	●		●	●						EK7301, EK7651H	-	A-87317
350	2.88	6	25.4	-	White	Asphalt									EK7301, EK7651H	-	966244011	
350	3.0	-	25.4	-	Green	Long life in abrasive materials									EK7301, EK7651H	-	966244030	
350	3.3	7	25.4	-	Silver	Concrete, Stone, Brick									EK7301, EK7651H	B	966344020	
350	3.0	6.5	25.4	-	Silver	Asphalt									EK7301, EK7651H	B	966344010	
355	2.8	10	25.4	-	Green	●	●		●	○						CE001G, CE002G, EK7301, EK7651H	A	E-12996
400	3.0	12	25.4	20	Red	●	●	●	●	●	●					EK8100	C	B-13471

\* 20, 22.23, 25.4 (Ring size)

## Diamond Wheel for Rescue Operation

### A - Vacuum Brazed Rescue Blade

These diamond blades are used for rescue operation and can cut various materials.

- Vacuum brazed diamond wheels are high durable and long-lasting.
- Extremely suitable for demolition work.



D	T	X	H	d	Color	For Material									For Model	Part No.	
						1	2	3	4	5	6	7	8	9			
230	3.1	4	22.23	-	RED	○	○	○	○	○	○	○	○	○	○	230mm Grinder & Power Cutter	B-55326
350	3.4	4	25.4	20	RED	○	○	○	○	○	○	○	○	○	355mm Power Cutter	B-55348	

## Diamond Blade For Wall Chaser

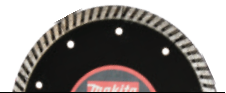

D	T	X	H	d	Color	For Material									For Model		Part No.	
						1	2	3	4	5	6	7	8	9				
150	2.4	7	22.23	-	Black		●	●		●	●				SG150	Segmented	DRY	P-22311
125	2	7.5	22.23	-	Blue		●	●		○	○				SG1251J	Segmented	DRY	A-80438

## Offset diamond wheel for Grinders / Concrete Planers

	Application	D	T	X	H	d	Color	For Material						For Model	Part No.
								1	2	3	4	5	6		
	<b>Rough Work</b> - Single Layer type	115	8	5	22.23	-	Gold	○	●		○	○	○	115mm, 125mm Grinders	D-60676
	<b>Fine Work</b> - Corrugated (Turbo) Type	100	8	5	16	-	Gold	●	●		●	○	○	100mm Grinders	D-62337
	<b>Fine Work</b> - For general use - Turbo Type	105	10	5	22.23	-	Gold	○	●		○	○	○	115mm, 125mm Grinders	B-44993
	<b>Rough Work</b> - For coarse grinding work - Single Type	105	4	8	22.23	-	Silver	○	●		○	○	○	115mm, 125mm Grinders	B-14629
	<b>Fine Work</b> - For fine finishing - Rim type	125	13.5	4	22.23	-	Gold	●	●		●	○	○	PC5000, PC5001C PC5010C 125mm Grinders	B-12289
	<b>Standard Work</b> - For coarse grinding work - For removing paint - Double Type	125	8	5	22.23	-	Gold	●	●		●	○	○	PC5000, PC5001C PC5010C	B-12295
	<b>Rough work</b> - Double Type	125		5	22.23	-	Gold	●	●		●	○	○	PC5000, PC5001C PC5010C	■ D-41458
	<b>Fine work</b> - Rim type	125		4	22.23	-	Gold	●	●		●	○	○	PC5000, PC5001C PC5010C	■ D-41464
	<b>Rough work</b> - Single type	180	8	5	22.23	-	Silver	○	●		○	○	○	180mm Grinder	D-62290
	<b>Standard Work</b> - Double type - Stable work	180	8	5	22.23	-	Silver	●	●		●	○	○	180mm Grinder	D-62321
	<b>Fine work</b> - Turbo type - Dust removal - Stable work, easy to grind the corners	180	8	5	22.23	-	Silver	●	●		●	○	○	180mm Grinder	D-62359

DRILLING / FIXING

CONCRETE DRILLING / DEMOLITION

MIXING / STIRRING

CUTTING (CONCRETE / METAL)

GRINDING

SANDING / POLISHING

SAWING

MULTI-TOOL

ROUTERS / PLANERS

NAILERS / STAPLERS

HEAT GUN / LASER

CLEANING

OPE

JOBSITE TOOLS

SPECIALTY TOOLS

HAND TOOLS / COMBINATION SET

TOOL HOLDERS AND POUCHES / MAKPAC SYSTEM

DRILLING / FIXING

CONCRETE DRILLING / DEMOLITION

MIXING / STIRRING

CUTTING (CONCRETE / METAL)

GRINDING

SANDING / POLISHING

SAWING

MULTI-TOOL

ROUTERS / PLANERS

NAILERS / STAPLERS

HEAT GUN / LASER

CLEANING

OPE

JOBSITE TOOLS

SPECIALTY TOOLS

HAND TOOLS / COMBINATION SET



TOOL HOLDERS AND POUCHES / MAKPAC SYSTEM

## PCD Offset diamond wheel for Grinders / Concrete Planers

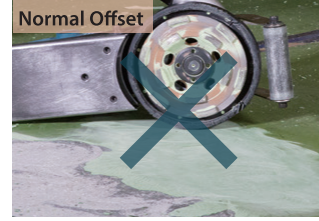
< Difference with the normal offset diamond >



It just scratched the surface and couldn't remove the paint film.

	Application	D	T	X	H	d	Color	For Material						For Model	Part No.	
								1	2	3	4	5	6			
	<b>PCD Offset</b> For removal of polyurethane, adhesive, paint, epoxy and acrylic coatings	125			22.23	-	Black								PC5000C/5001C PC5010C or 125mm Grinders (with SJS, SJS II or Soft start)	<b>B-53160</b>
	<b>PCD Offset</b> For removal of polyurethane, adhesive, paint, epoxy and acrylic coatings	180			22.23	-	Black								180mm Grinders (with SJS, SJS II or Soft start)	<b>B-53176</b>

### Ring (10 pc/ set)



Type	(H)Outer Dia	(D)Hole Dia	Part No.
Ring 20	22.23mm	20mm	A-85248

## Vacuum Brazed Diamond Core Bit For Grinders

- Used with high speed angle grinders.
- Suitable for quick drilling.
- Material : Granite/Marble/Porcelain Tile



Available in different shapes and sizes



Dia	Spindle Thread	Type	Material	Part no
5mm				D-61064
6mm				D-61070
8mm				D-61086
10mm				D-61092
12mm				D-61101
14mm				D-44432
16mm				D-44448
20mm	M14	Dry	For Granite / Marble / Tile	D-44454
22mm				D-44460
25mm				D-44476
27mm				D-44482
30mm				D-44498
32mm				D-44507
35mm				D-44513
38mm				D-44529
40mm				D-44535

# Abrasive Wheel Label



Lot number and validity : on washer (If it is not on washer, it will be on the label)

## Point 1: The icon indicates application of the wheel

	For metal	For INOX	For Masonry
Grinding			
Cutting			
Cutting for portable cut-off		—	—
Cutting for power cutter		—	

## Point 2: The colour indicates the material for which the wheel can be used

	For metal	For INOX	For Masonry
Colour	 Blue	 Orange	 Green
Label Design	→ Old label      New label	→ Old label      New label	→ Old label      New label

- DRILLING / FIXING
- CONCRETE DRILLING / DEMOLITION
- MIXING / STIRRING
- CUTTING (CONCRETE / METAL)
- GRINDING**
- SANDING / POLISHING
- SAWING
- MULTI-TOOL
- ROUTERS / PLANERS
- NAILERS / STAPLERS
- HEAT GUN / LASER
- CLEANING
- OPE
- JBSITE TOOLS
- SPECIALTY TOOLS
- HAND TOOLS / COMBINATION SET
- TOOL HOLDERS AND POUCHES / MAKPAC SYSTEM

- DRILLING / FIXING
- CONCRETE DRILLING / DEMOLITION
- MIXING / STIRRING
- CUTTING (CONCRETE / METAL)
- GRINDING**
- SANDING / POLISHING
- SAWING
- MULTI-TOOL
- ROUTERS / PLANERS
- NAILERS / STAPLERS
- HEAT GUN / LASER
- CLEANING
- OPE
- JOBSITE TOOLS
- SPECIALTY TOOLS
- HAND TOOLS / COMBINATION SET
- TOOL HOLDERS AND POUCHES / MAKPAC SYSTEM

## Point 3: How to read the specs



### Wheel Type

T27: Depressed center - Grinding Wheel  
 T42: Depressed center - Cutting Wheel  
 T41: Flat center - Cutting Wheel

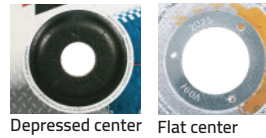

Depressed center Flat center



### Aluminum Oxide Group ( mainly for metal & INOX )

**Brown Fused Aluminum: A**  
 The most common abrasive material for metal.



**Single Aluminum Oxide: SA**  
 Single crystal abrasive material with high tenacity. Higher durability and grinding/cutting performance than A.



**White Aluminum Oxide: WA**  
 High purity abrasive material, eliminated extraneous elements from A. Higher grinding and cutting performance than A.



**Alumina Zirconium: Z**  
 Extremely sharp and hard abrasive material. Grinding/cutting performance than SA.



### Grit Size

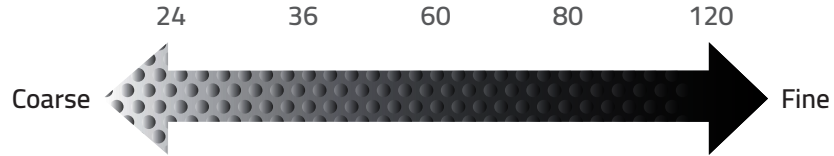

### Hardness of grinding wheel

Closer to A, soft grinding wheel  
 Closer to Z, hard grinding wheel

Soft grinding wheel ▶ Hard work piece  
 Hard grinding wheel ▶ Soft work piece

Very Soft	Soft	Middle	Hard	Very Hard
A - G	H - K	L - O	P - S	T - Z

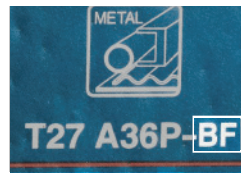

### Type of Bond

BF : Reinforced resinoid bond  
 V : Vitrified bond



# X-LOCK ACCESSORIES

Easy installing and removing the accessories in one step  
 Improve your work efficiency and work environment!

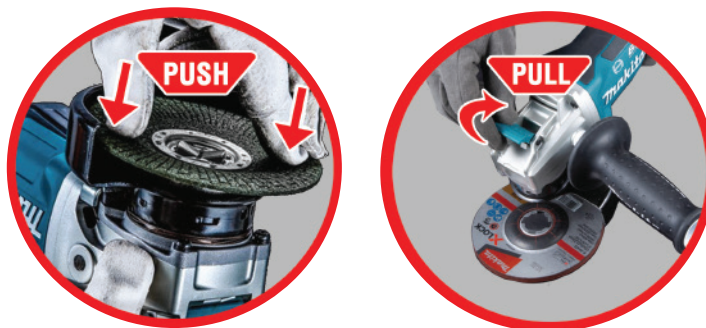

- Abrasive Grinding and Thin Cutting wheel for X-Lock Grinders
- No burn mark and burr
- Less Vibration

**1.2mm Thickness**  
 (for thin cutting wheels)

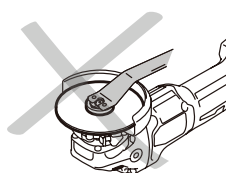

X-LOCK mechanism ensures that the accessory is properly mounted to the tool without a nut, flange or spanner and cannot be mounted incorrectly. 115mm and 125mm X-lock wheels are also compatible with conventional angle grinders

## X-Lock Thin Cutting Wheels

Size (mm)	Grit	Max. RPM	Unit per carton	Part No.
115x1.2x22.23	A60T Inox - Mild Steel	13,300	50	E-00387
125x1.2x22.23	A60T Inox - Mild Steel	12,250	50	E-00418

## X-Lock Depressed Center Grinding Wheels

Size (mm)	Grit	Max. RPM	Unit per carton	Part No.
115x6.0x22.23	A36P - Metal	13,300	25	E-00365
125x6.0x22.23	A36P - Metal	12,250	25	E-00393

- DRILLING / FIXING
- CONCRETE DRILLING / DEMOLITION
- MIXING / STIRRING
- CUTTING (CONCRETE / METAL)
- GRINDING**
- SANDING / POLISHING
- SAWING
- MULTI-TOOL
- ROUTERS / PLANERS
- NAILERS / STAPLERS
- HEAT GUN / LASER
- CLEANING
- OPE
- JOB SITE TOOLS
- SPECIALTY TOOLS
- HAND TOOLS / COMBINATION SET
- TOOL HOLDERS AND POUCHES / MAK-PAC SYSTEM

- DRILLING / FIXING
- CONCRETE DRILLING / DEMOLITION
- MIXING / STIRRING
- CUTTING (CONCRETE / METAL)
- GRINDING**
- SANDING / POLISHING
- SAWING
- MULTI-TOOL
- ROUTERS / PLANERS
- NAILERS / STAPLERS
- HEAT GUN / LASER
- CLEANING
- OPE
- JOB SITE TOOLS
- SPECIALTY TOOLS
- HAND TOOLS / COMBINATION SET
- TOOL HOLDERS AND POUCHES / MAKPAC SYSTEM

# Flat Center Thin Cutting Wheels - E-series

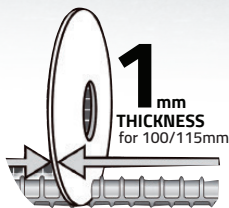

**HIGH EFFICIENCY  
FAST CUTTING**



**LONG LIFE**



**NO BURN MARK  
AND BURR**

**FE, S, Cl < 0.1%**  
These wheels have low Fe (Iron), S (Sulphur), Cl (Chlorine) content to prevent stainless steel surface from rusting after cutting



**STAINLESS STEEL**



**ALUMINIUM**

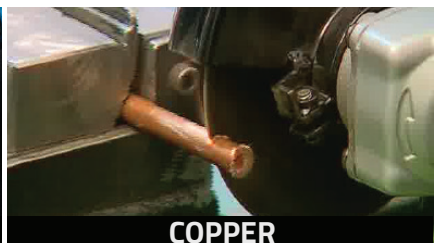

**COPPER**

Size (mm)	Grit	Package type	Unit per carton	Max. RPM	Part No.
100 x 1.0 x 16mm	Inox A60U	10pcs Shrink Wrapped wheels	40	15,300	■ E-03028
115 x 1.0 x 22.23mm	Inox A60U		50	13,300	■ E-03034
125 x 1.0 x 22.23mm	Inox A60U		50	12,250	■ E-03040
150 x 1.6 x 22.23mm	Inox A60U		40	10,200	■ E-13742
180 x 1.6 x 22.23mm	Inox A60U		40	8,300	■ E-13758
230 x 1.9 x 22.23mm	Inox A60U		40	6,650	■ E-13764

# Flat Center Thin Cutting Wheels - B-series

Size (mm)	Grit	Package type	Unit per carton	Max. RPM	Part No.
100 x 1.0 x 16mm	Inox A60T	10pcs Shrink Wrapped wheels	40	15,300	B-12201
115 x 1.0 x 22.23mm	Inox A60T		50	13,300	B-12217
150 x 1.6 x 22.23mm	Inox A60T		40	10,200	B-12251
180 x 1.6 x 22.23mm	Inox A60T		40	8,300	B-12267
230 x 1.9 x 22.23mm	Inox A60T		40	6,650	B-12273

## Flat Center Thin Cutting Wheels - D-series

### Application/ Recommended Use

- Higher cutting speeds, up to 2-3 times faster than 3mm thin wheels.
- Reduced wastage of work materials.
- No discoloration (rust) around stainless steel cutting edge.

Size (mm)		Grit	Max. RPM	Unit per carton	Part No.
100 x 1.0 x 16		WA60T	15,280	100	D-18758
115 x 1.2 x 22.23		WA60T	13,290	100	D-18764
125 x 1.2 x 22.23		WA60T	12,200	100	D-18770
180 x 2.0 x 22.23		WA36R	8,600	50	D-18786
230 x 2.0 x 22.23		WA36R	6,600	50	D-18792

## Depressed Center Cutting Wheel (D-series)

### A30S : For Metal

Size (mm)		Grit	Max. RPM	Unit per carton	Part No.
100 x 3.0 x 16.00		A30S	15,280	25	D-18552
115 x 3.0 x 22.23			13,290	25	D-18568
125 x 3.0 x 22.23			12,200	25	D-18574
180 x 3.0 x 22.23			8,600	25	D-18580
230 x 3.0 x 22.23			6,600	25	D-18596

## Depressed Center Cutting Wheel (A/B-series)

### A30T : For Metal

- For fast, clean cuts, notching and slotting

Size (mm)		Grit	Max. RPM	Unit per carton	Part No.
100 x 3.0 x 16.00		A30T	13,690	25	A-83587
115 x 3.0 x 22.23			13,290	40	A-83593
125 x 3.0 x 22.23			12,250	40	A-83602
150 x 3.0 x 22.23			10,190	15	B-05050
180 x 3.0 x 22.23			8,500	15	A-83618
230 x 3.0 x 22.23			6,650	15	B-62913

## Depressed Center Grinding Wheel (D-series)

### A24R: For Metal

Size (mm)	Grit	Max. RPM	Unit per carton	Part No.
115 x 6.0 x 22.23	A24R	13,290	25	D-18459
125 x 6.0 x 22.23	A24R	12,250	25	D-18465

DRILLING  
/ FIXINGCONCRETE  
DRILLING /  
DEMOLITIONMIXING /  
STIRRINGCUTTING  
(CONCRETE /  
METAL)

GRINDING

SANDING /  
POLISHING

SAWING

MULTI-TOOL

ROUTERS /  
PLANERSNAILERS /  
STAPLERSHEAT GUN /  
LASER

CLEANING

OPE

JOBSITE  
TOOLSSPECIALTY  
TOOLSHAND TOOLS /  
COMBINATION SETTOOL HOLDERS  
AND POUCHES /  
MAKPAC SYSTEM

DRILLING /  
FIXINGCONCRETE  
DRILLING /  
DEMOLITIONMIXING /  
STIRRINGCUTTING  
(CONCRETE /  
METAL)

GRINDING

SANDING /  
POLISHING

SAWING

MULTI-TOOL

ROUTERS /  
PLANERSNAILERS /  
STAPLERSHEAT GUN /  
LASER

CLEANING

OPE

JOBSITE  
TOOLSSPECIALTY  
TOOLSHAND TOOLS /  
COMBINATION SETTOOL HOLDERS  
AND POUCHES /  
MAKPAC SYSTEM

## Depressed Center Grinding Wheel (A-series)

**A36P** : For metal

**WA36N / WA36O** : For stainless steel

- For metal polishing and general flat grinding

Size (mm)	Grit	Max. RPM	Unit per carton	Part No.
100 x 6.0 x 16.00	WA36N	13,690	25	A-80852
115 x 6.0 x 22.23	WA36N	13,300	25	A-80640
125 x 6.0 x 22.23	WA36N	12,250	25	A-80656
180 x 6.0 x 22.23	WA36O	8,500	10	A-80880
230 x 6.0 x 22.23	WA36N	6,600	10	A-80896
100 x 6.0 x 16.00	A36P	13,690	25	A-80911
115 x 6.0 x 22.23	A36P	13,290	25	A-80927
125 x 6.0 x 22.23	A36P	12,250	25	A-80933
150 x 6.0 x 22.23	A36P	10,190	10	A-84981
180 x 6.0 x 22.23	A36P	8,500	10	A-80949
230 x 6.0 x 22.23	A36P	6,650	10	A-80955



## Abrasive cut-off wheel (for Portable Cut-off)

- 3mm thickness
- For all ferrous materials - Steel, Cast iron and other hard metals



Size (mm)	Grit	Pcs Per Pkg	Max. RPM	Part No.
305 x 3.0 x 25.4	A36P	25	4,500	A-87650-25
355 x 3.0 x 25.4	A36T	25	3,900	E-10540-25
355 x 3.0 x 25.4	A36P	25	3,900	A-87672-25
405 x 3.0 x 25.4	A36P	25	3,380	A-87694-25

## Abrasive cut-off wheel (For power cutter)

- Always ensure the max RPM of the wheel matches the power cutter



Size (mm)	Grit	Max. RPM	Pcs / Pkg	Part No.
230 x 3.0 x 22.23	Metal	6650 min <sup>-1</sup>	1	B-62913
300 x 3.5 x 20 mm	Metal	5100 min <sup>-1</sup>	1	B-70792
350 x 4.0 x 25.4 mm	Metal	5500 min <sup>-1</sup>	1	B-70839
350 x 4.0 x 25.4 mm	Stone	5500 min <sup>-1</sup>	1	B-70823
355 x 4.3 x 25.4 mm	Metal	5500 min <sup>-1</sup>	5pcs set	■ E-12790-5

# Flap Disc

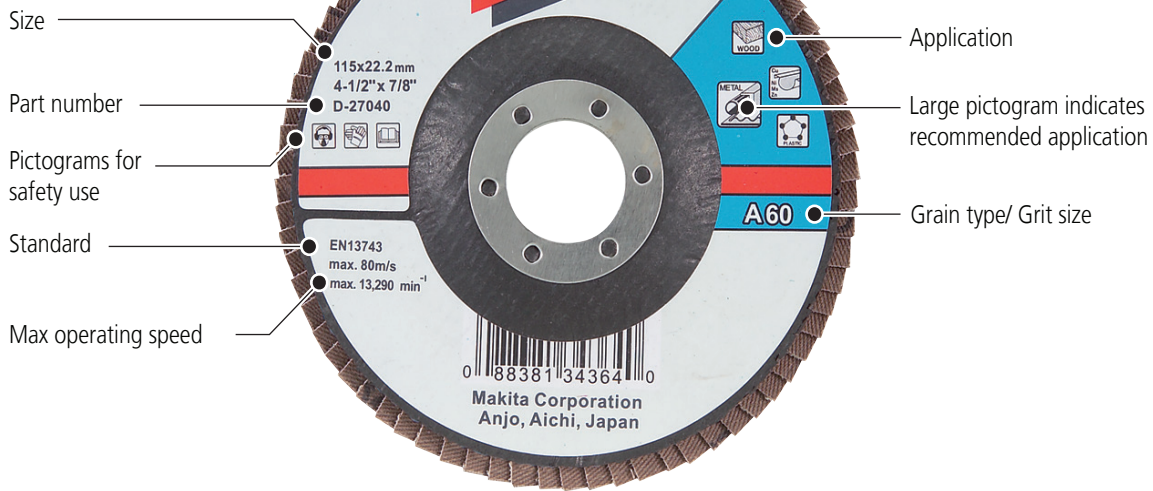

- DRILLING / FIXING
- CONCRETE DRILLING / DEMOLITION
- MIXING / STIRRING
- CUTTING (CONCRETE / METAL)
- GRINDING**
- SANDING / POLISHING
- SAWING
- MULTI-TOOL
- ROUTERS / PLANERS
- NAILERS / STAPLERS
- HEAT GUN / LASER
- CLEANING
- OPE
- JBSITE TOOLS
- SPECIALTY TOOLS
- HAND TOOLS / COMBINATION SET
- TOOL HOLDERS AND POUCHES / MAKPAC SYSTEM

**Backing Type**

**Fiber glass backing**  
Standard backing type

**Nylon backing**  
For heavy duty

**Shape Type**

**Flat**  
Effective for flat surface

**Angled**  
Effective for angles or corners

# Material Chart

AA : Recommended A : Acceptable

Description of Grit Material	Aluminum oxide (A)	Zirconia aluminum (Z)	Silicon carbide (C)
Description of label color	Best for metal	Best for INOX and metal	Best for Masonry
Wood	A		
Plastic	A		
Metal	AA	AA	
No ferrous	A	A	
INOX		AA	
Masonry			AA

## Flap Disc Series

DRILLING / FIXING

CONCRETE DRILLING / DEMOLITION

MIXING / STIRRING

CUTTING (CONCRETE / METAL)

GRINDING

SANDING / POLISHING

SAWING

MULTI-TOOL

ROUTERS / PLANERS

NAILERS / STAPLERS

HEAT GUN / LASER

CLEANING

OPE

JOBSITE TOOLS

SPECIALTY TOOLS

HAND TOOLS / COMBINATION SET

TOOL HOLDERS AND POUCHES / MAKPAC SYSTEM

### Material - Zirconia Aluminium:

For sanding and grinding metals and stainless steel. Sands flat, contoured or curved surfaces like a sanding disc.



BEST



OPTIONAL

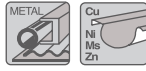

Grit	Dia. (mm)	Grain	Application	Backing type	Backing Shape	Part No. P-Series	Part No. D-Series
Z 36	115 (4-1/2")	Zirconia Aluminium	Stainless Steel	Fiber Glass	Angled		D-27420
Z 40						D-27436	
Z 60						D-27442	
Z 80						D-27458	
Z 120						D-27464	
Z 36	125 (5")	Zirconia Aluminium	Stainless Steel	Fiber Glass	Angled		D-27470
Z 40						D-27486	
Z 60						D-27492	
Z 80						D-27501	
Z 120						D-27517	
Z 36	180 (7")	Zirconia Aluminium	Stainless Steel	Fiber Glass	Angled		D-27523
Z 40						P-39182	D-27539
Z 60							D-27545
Z 80							D-27551
Z 120							D-27567

### Material-Silicon Carbide: Effective for sanding brick, stone & concrete.



BEST



Grit	Dia. (mm)	Grain	Application	Backing type	Backing Shape	Part No
C 36	115	Silicon Carbide	Masonry	Fiber Glass	Flat	D-28020
C 40						D-28036
C 60						D-28042
C 80						D-28058
C 120						D-28064
C 36	125	Silicon Carbide	Masonry	Fiber Glass	Flat	D-28070
C 40						D-28086
C 60						D-28092
C 80						D-28101
C 120						D-28117
C 120	170	Silicon Carbide	Masonry	Fiber Glass	Flat	P-39350
C 36	D-28123					
C 40	D-28139					
C 60	D-28145					
C 80	D-28151					
C 120						D-28167

**Zirconia Aluminium:** Suitable for grinding general steel, stainless steel, removing burrs and welding marks, chamfering, removing rust and paint, etc.



BEST



OPTIONAL

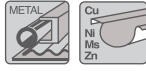

Grit	Dia. (mm)	Grain	Application	Backing type	Backing Shape	Part No
Z40	100	Zirconia Aluminium	Stainless Steel	Fibre Glass Backing / Flat	Flat	D-74142
Z60						D-74158
Z80						D-74164
Z120						D-74170
Z40	115	Zirconia Aluminium	Stainless Steel	Fibre Glass Backing / Flat	Flat	D-74186
Z60						D-74192
Z80						D-74201
Z120						D-74217
Z40	125	Zirconia Aluminium	Stainless Steel	Fibre Glass Backing / Flat	Flat	D-74223
Z60						D-74239
Z80						D-74245
Z120						D-74251
Z40	180	Zirconia Aluminium	Stainless Steel	Fibre Glass Backing / Flat	Flat	D-74267
Z60						D-74273
Z80						D-74289
Z120						D-74295

### Material-Aluminium Oxide: For sanding metal, plastic, wood & steel.



BEST



OPTIONAL



Grit	Dia. (mm)	Grain	Application	Backing type	Backing Shape	Part No
A 36	115	Aluminium Oxide	Steel	Fiber Glass	Angled	D-27028
A 40						D-27034
A 60						D-27040
A 80						D-27056
A 120						D-27062
A 36	125	Aluminium Oxide	Steel	Fiber Glass	Angled	D-27078
A 40						D-27084
A 60						D-27090
A 80						D-27109
A 120						D-27115
A 36	180	Aluminium Oxide	Steel	Fiber Glass	Angled	D-27121
A 40						D-27137
A 60						D-27143
A 80						D-27159
A 120						D-27165

## Industrial Flap Disc for Heavy Duty



### Material - Zirconia Aluminium:

For sanding and grinding metals and stainless steel. Sands flat, contoured or curved surfaces like a sanding disc.  
High efficiency & Long life.  
Suitable for Industry use.



### For Applications

**BEST** **BETTER**

STAINLESS INOX NIROSTA METAL

Cu Ni Ms Zn

Grit	Dia. (mm)	Grain	Application	Backing type	Backing Shape	Part No. B-Series
Z 40	115 (4-1/2")			Fiber Glass	Angled	B-55603
Z 60						B-55619
Z 80						B-55625
Z 120						B-55631

### Feature

- High efficiency.
- Long life.
- Suitable for industrial work site such as dockyard, metal working place and other heavy duty applications.
- High-speed Grinding with high-power grinder.
- Remove the rust and burrs.



### Efficiency

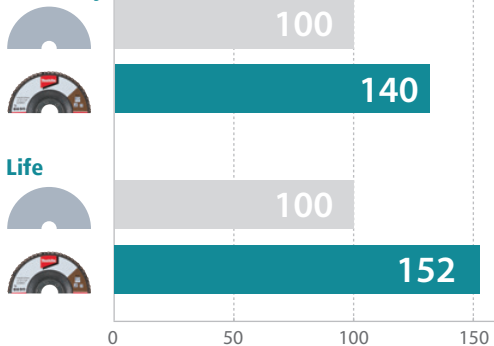

## Rubber Pad & Locknut for Angle Grinder



Wheel size	Spindle thread	Rubber pad			Sanding lock nut		Lock nut wrench	
		Size	Max. RPM	Part No.	Size	Part No.	Size	Part No.
9500N	M10 x 2.5	76mm	13700rpm	743009-6	30	224501-6	20	782401-1
115mm	M14 x 2 (DIN)	100mm	12000rpm	743036-3	48	224515-5	28/35	782412-6, 782424-9 / 782407-9, 782423-1
125mm	M14 x 2 (DIN)	115mm	12000rpm	743015-1	48	224515-5	28/35	782412-6, 782424-9 / 782407-9, 782423-1
150mm	M14 x 2 (DIN)	125mm	10950rpm	743016-9	48	224515-5	28/35	782412-6, 782424-9 / 782407-9, 782423-1
180 - 230mm	M14 x 2 (DIN)	170mm	8500rpm	743012-7	48	224515-5	28/35	782412-6 / 782407-9
180mm - 230mm	M16	170mm	8500rpm	743012-7	48	224523-6	28/35	782412-6 / 782407-9

DRILLING / FIXING

CONCRETE DRILLING / DEMOLITION

MIXING / STIRRING

CUTTING (CONCRETE / METAL)

GRINDING

SANDING / POLISHING

SAWING

MULTI-TOOL

ROUTERS / PLANERS

NAILERS / STAPLERS

HEAT GUN / LASER

CLEANING

OPE

JOB SITE TOOLS

SPECIALTY TOOLS

HAND TOOLS / COMBINATION SET

TOOL HOLDERS AND POUCHES / MAKPAC SYSTEM

- DRILLING / FIXING
- CONCRETE DRILLING / DEMOLITION
- MIXING / STIRRING
- CUTTING (CONCRETE / METAL)
- GRINDING
- SANDING / POLISHING
- SAWING
- MULTI-TOOL
- ROUTERS / PLANERS
- NAILERS / STAPLERS
- HEAT GUN / LASER
- CLEANING
- OPE
- JOBSITE TOOLS
- SPECIALTY TOOLS
- HAND TOOLS / COMBINATION SET
- TOOL HOLDERS AND POUCHES / MAKPAC SYSTEM

## Abrasive Disc

For stone and plastics.



Outer Diameter (mm)	Grit	Pc Per Pkg	Max. RPM	Part No.
100	C24	10	13,700	794065-9
	C30	10	13,700	794066-7
	C50	10	13,700	794067-5
	C80	10	13,700	794068-3
	C100	10	13,700	794227-9
	C120	10	13,700	794069-1
	115	C24	10	11,950
C30		10	11,950	794105-3
C50		10	11,950	794106-1
C80		10	11,950	794107-9
C120		10	11,950	794108-7
125	C24	10	11,000	794096-8
	C30	10	11,000	794097-6
	C50	10	11,000	794098-4
	C80	10	11,000	794099-2
	C120	10	11,000	794100-3

Outer Diameter (mm)	Grit	Pc Per Pkg	Max. RPM	Part No.
150	C24	10	9,200	794070-6
	C30	10	9,200	794071-4
	C50	10	9,200	794072-2
	C80	10	9,200	794073-0
	C120	10	9,200	794074-8
	C16	10	7,600	794091-8
180	C20	10	7,600	794092-6
	C24	10	7,600	794093-4
	C30	10	7,600	794218-0
	C50	10	7,600	794094-2
	C80	10	7,600	794095-0
	C100	10	7,600	794220-3
	C120	10	7,600	794221-1

For wood, iron and steel

178	20	5	-	P-01074
	50	5	-	P-01068
	80	5	-	P-01080

## Safety Flanges

Makita recommends the use of SAFETY FLANGES when using flat abrasive cutting wheels with large angle grinders. The safety flanges are larger in diameter compared to the standard flanges supplied with the machines. The larger diameter safety flanges offer greater support to the flat abrasive cutting wheels, thereby reducing the risks of wheel damage and ensuring operator safety.

We strongly recommend to use these flanges with the Thin Metal Cutting Wheels of sizes 180mm and 230mm

### Main Benefits:

- ✓ Drastically reduces wheel breakage
- ✓ Straight line cutting due to less flexing
- ✓ Cuts a narrow groove due to blades stability
- ✓ Less wheel vibration – operator comfort
- ✓ Less vibration reduces machine wear

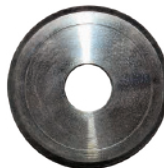

Inner Flange



Outer Flange

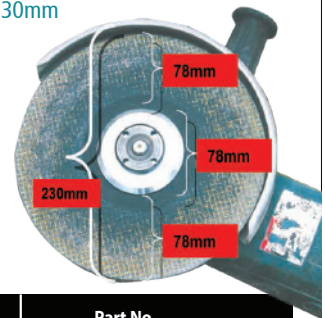

A: Outer Flange ( Use with Lock nut 224543-0)  
B: Inner Flange

Outer Diameter (mm)	Spindle Thread	For Grinder size	Type	Part No.
78	M14 X 2 (DIN)	180, 230mm	Outer Flange	224256-3
			Inner Flange	224257-1

## Super Flanges

For Depressed Center Wheel & Diamond Wheel

Use of the Super Flange makes it easy to remove the Grinding Wheel etc. after grinding operations. The lock nut can be removed with only about one third of the force required to remove a conventional inner flange. The method of installation and use are the same as for the usual inner flange.



Outer Diameter (mm)	Spindle Thread	For Grinder size	Part No.
47	M14 X 2 (DIN)	115, 125, 150, 180, 230mm	192227-7



## Safety Guidelines: Abrasive Wheels

### Do's

- 1 Always handle and store all wheels in a very careful manner



- 3
  - Visually check all wheels for damage or cracks before mounting and using them
  - Allow newly mounted wheel to run for 1-min. in a protected area before use



- 4
  - Always use a machine safety guard and back-up pad if required
  - Use mounting flanges that are clean, flat of equal size and proper type
  - Use safety flanges when using flat abrasive cutting wheels of 180 / 230mm diameter

- 2 Make sure machine speed does not exceed the RPM marked on the wheel



Always wear eye protection, protective clothing, safety gloves, and dust mask.



Prevent the dust from scattering by using dust extractors on the grinders to protect operators from respiratory diseases

### Dont's

- 1 Do not use wheels that have been subjected to excessive humidity, moisture or temperature

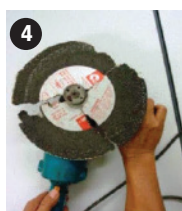

Do not use wheels that have been dropped or appear to have been damaged

- 2 Do not exceed the maximum operating speed marked on wheels



Do not force a wheel onto the machine or alter the hole size. Do not tighten the mounting nut excessively

- 3 Do not stand directly in front of wheel when machine is started

Do not grind or cut without proper protective equipment



Do not grind or cut material for which the wheel is not designed. Do not use grinding wheel for cutting or notching

DRILLING / FIXING

CONCRETE DRILLING / DEMOLITION

MIXING / STIRRING

CUTTING (CONCRETE / METAL)

GRINDING

SANDING / POLISHING

SAWING

MULTI-TOOL

ROUTERS / PLANERS

NAILERS / STAPLERS

HEAT GUN / LASER

CLEANING

OPE

JOBSITE TOOLS

SPECIALTY TOOLS

HAND TOOLS / COMBINATION SET

TOOL HOLDERS AND POUCHES / MAKPAC SYSTEM

DRILLING /  
FIXING

CONCRETE  
DRILLING /  
DEMOLITION

MIXING /  
STIRRING

CUTTING  
(CONCRETE /  
METAL)

GRINDING

SANDING /  
POLISHING

SAWING

MULTI-TOOL

ROUTERS /  
PLANERS

NAILERS /  
STAPLERS

HEAT GUN /  
LASER

CLEANING

OPE

JOBSITE  
TOOLS

SPECIALTY  
TOOLS

HAND TOOLS /  
COMBINATION SET

TOOL HOLDERS  
AND POUCHES /  
MAKPAC SYSTEM

### Wire brush for angle grinder with X-lock - Crimped

• Can be used for heavy duty cleaning of large metal surfaces, rust and paint removal, removal of weld scale and corrosion, surface preparation for painting and welding, auto body finish and repair.

- 0.3mm crimped steel wire
- Suitable for polishing corners.

For Model: **A:** for 100, 115, 125mm angle grinders (X-LOCK)



**XLOCK**

Outer Diameter (mm)	Type	Max. RPM	Part No.
75	A	12,500	D-73396

### Wire brush for angle grinder with X-lock - Knotted

- For heavy duty professional use
- Strong brushes with the highest safety working standards
- Heavy duty cleaning of large metal surfaces
- Ideal to remove slags rust paint and hard incrustations/layers.
- Knot cup (0.5mm Steel)
- 0.3mm crimped steel wire
- Suitable for polishing pinpoint corners

For Model **A:** for 115, 125mm Angle grinders (X-LOCK)



**XLOCK**

Outer Diameter (mm)	Type	Max. RPM	Part No.
115	A	12,500	D-73405

### Wire Cup Brush - Crimped Wire D- Series

- Ideal for flat surfaces, edges, light rust removal.
- 0.3mm crimped steel wire

A: for 100mm angle grinder  
B: for 115, 125, 150mm angle grinder  
C: for 180mm, 230mm angle grinder



Outer Diameter (mm)	Spindle Thread	Type	Max. RPM	Part No.
60	M10 x 1.5	A	12,500	D-24066
60	M14 x 2	B	12,500	D-24072
75	M10 x 1.5	A	12,500	D-24088
75	M14 x 2	B	12,500	D-24094
75	M10 x 1.5	A	12,500	794162-1
110	M16 x 2	C	9,000	794325-9

### Wire Cup Brush - Twisted (Knotted wire)

• Can be used for heavy duty cleaning of large metal surfaces, rust and paint removal, removal of weld scale and corrosion, surface preparation for painting and welding, auto body finish and repair.

- 0.3mm crimped steel wire

For Model:

**A:** M10: for 100mm angle grinder  
**B:** M14: for 115, 125, 150mm angle grinder



Outer Diameter (mm)	Spindle Thread	Type	Max. RPM	Part No.
60	M10 x 1.5	A	12,500	D-24103
60	M14 x 2	B	12,500	D-24119
75	M10 x 1.5	A	12,500	D-24125
75	M14 x 2	B	12,500	D-24131

### Wire Cup Brush - Twisted with metal cover (Knotted wire)

• Can be used for heavy duty cleaning of large metal surfaces, rust and paint removal, removal of weld scale and corrosion, surface preparation for painting and welding, auto body finish and repair.

- 0.3mm crimped steel wire

For Model:

**A:** M10: for 100mm angle grinder  
**B:** M14: for 115, 125, 150mm angle grinder



Outer Diameter (mm)	Spindle Thread	Type	Max. RPM	Part No.
60	M10 x 1.5	A	12,500	D-24147
60	M14 x 2	B	12,500	D-24153

### Wire Cup Brush (Crimped Cup) T-series

- For heavy duty professional use
  - Suitable for wood, paint, rust removal & many other applications.
  - 0.5mm knotted steel wire
- For Model: **A:** 115, 125mm  
**B:** 180mm **C:** 180, 230mm



Outer Diameter (mm)	Spindle Thread	Type	Max. RPM	Part No.
100	M14 -5/8"-11	B	8,500	T-02004
120	M14 -5/8"-11	C	8,500	T-02010

DRILLING / FIXING

CONCRETE DRILLING / DEMOLITION

MIXING / STIRRING

CUTTING (CONCRETE / METAL)

GRINDING

SANDING / POLISHING

SAWING

MULTI-TOOL

ROUTERS / PLANERS

NAILERS / STAPLERS

HEAT GUN / LASER

CLEANING

OPE

JOBSITE TOOLS

SPECIALTY TOOLS

HAND TOOLS / COMBINATION SET

TOOL HOLDERS AND POUCHES / MAKPAC SYSTEM

### Wire Cup Brush (Twisted) P-series

- For heavy duty professional use
  - Strong brushes with the highest safety working standards
  - Heavy duty cleaning of large metal surfaces
  - Ideal to remove slags rust paint and hard incrustations/layers.
  - Knot cup (0.5mm Steel)
- For Model: **A:** 115, 125mm

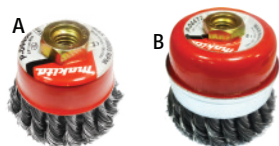

Outer Diameter (mm)	Spindle Thread	Type	Max. RPM	Part No.
75	M14-5/8"-11	A	12,500	P-04488
85	M14-5/8"-11	B	8,500	P-04472

### Wire Bevel Cup Brush (Twisted) P-series

- For heavy duty professional use
  - Strong brushes with the highest safety working standards
  - Heavy duty cleaning of large metal surfaces
  - Ideal to remove slags rust paint and hard incrustations/layers.
  - Knot cup (0.5mm Steel)
- For Model: **A:** 115, 125mm



Outer Diameter (mm)	Spindle Thread	Type	Max. RPM	Part No.
95	M14-5/8"-11	-	12,500	P-04494

### Mounted Flap Wheel

#### Grinding and finishing for various materials and applications

Ideal accessory for hard-to-access areas such as the internal of irregular shape.

#### Application for various materials

surfaces of pipes, cylinders, moulds, curved surfaces and parts

Suitable for Die Grinders GD0810C and GD0811C or with the die grinders which has lesser RPM than the mounted flap wheels

Suitable for Driver Drill and Percussion Driver Drill with aluminium gear housing (Cannot be used with a drill that uses resin housing)



Dia	Length	Shank	Grit	RPM	Pcs /Pkg	Part no
50mm	30mm	6mm	A40	15,300	14	D-75219
			A60	15,300	14	D-75225
			A80	15,300	14	D-75231
			A120	15,300	14	D-75247
60mm	30mm	6mm	A40	12,750	10	D-75253
			A60	12,750	10	D-75269
			A80	12,750	10	D-75275
			A120	12,750	10	D-75281

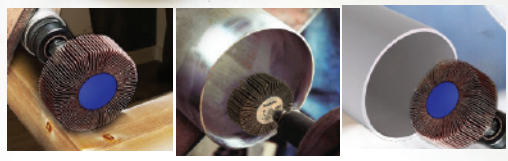

WOOD

METAL

PVC



PIPE

90° ANGLE

CURVED SURFACE

DRILLING /  
FIXINGCONCRETE  
DRILLING /  
DEMOLITIONMIXING /  
STIRRINGCUTTING  
(CONCRETE /  
METAL)

GRINDING

SANDING /  
POLISHING

SAWING

MULTI-TOOL

ROUTERS /  
PLANERSNAILERS /  
STAPLERSHEAT GUN /  
LASER

CLEANING

OPE

JOBSITE  
TOOLSSPECIALTY  
TOOLSHAND TOOLS /  
COMBINATION SETTOOL HOLDERS  
AND POUCHES /  
MAKPAC SYSTEM

## Wheel point for Die Grinders

For model: 906H, GD0600, GD0602, GD0800C, GD0810C, DGD800, GD0603

### Abrasive material

A: To grind mild steel, carbon steel, etc.

WA: To grind hardened and special steels.

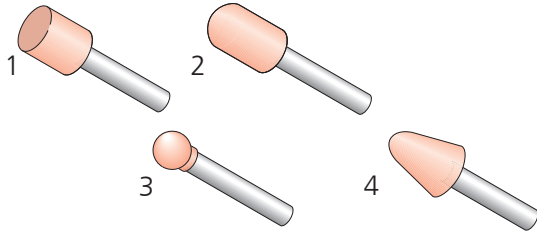

No.	Wheel Dia.(mm)	Shank Size(mm)	Abrasive Material	Pc/Pkg	Part No.
1	5	3	A	10	794050-2
1	6	3	A	10	794051-0
1	8	3	A	10	794052-8
1	10	3	A	10	794053-6
2	5	3	WA	10	794054-4
2	6	3	WA	10	794055-2
2	8	3	WA	10	794056-0
2	10	3	WA	10	794057-8
3	5	3	A	10	A-23450
3	10	3	A	10	794059-4
1	19	6	WA	1	741614-3
1	19	1/4"	WA	1	741617-7
4	19	6	WA	1	741615-1
4	19	1/4"	WA	1	741616-9

## Collet Cone for Die Grinders



For Model	Size	Part No.
903	3mm	763610-1
906, 906H, GD0600, GD0601, GD0603	1/8"	763626-6
	3mm	763627-4
	6mm	763620-8
	1/4"	763625-8
GD0602, DGD800	6mm	763670-3
GD0800C, GD0810C	3mm	193011-3
	6mm	193012-1
	1/4"	193143-6
	8mm	192988-9
	1/8"	193144-4

### Collet nut

For Model	Part No.
906, 906H	763240-8
GD0600, GD0601	763664-8
GD0603	763236-9
GD0602	763668-0
GD0800C, GD0810C	763645-2

## Dressing Stone



Thickness mm	Size	Part No.
20.0	180x70mm	794060-9
20.0	150x70mm	794061-7

## Tungsten Carbide Burrs for Die Grinders

- i) Clean the burrs on Inox / Metal pipe
- ii) Wipe the welding line between steel plate
- iii) Remove the scar of iron pipe inner side
- iv) Deburr of aluminium product



10pcs pkg

- Available in different shapes and sizes
- Comes in a pack of 10pcs
- Used on die grinder - max speed less than 33,000rpm
- Standard cut burrs quickly remove stock
- Can be used on different metal such as steel, inox

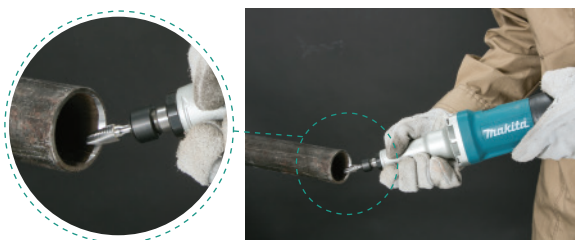

Suitable for Die Grinders models: GD0800C, GD0801C, GD0600, GD0602  
 Not suitable for 906, 906H, GD0810C / GD0811C

Size	Head Shape	pc /Pkg	Part no
12x25x6mm		10	B-62402-10
12x25x6mm		10	B-62418-10
12x25x6mm		10	B-62424-10
12x28x6mm		10	B-62430-10
12x25x6mm		10	B-62446-10

## Grinding Wheel for Straight Grinder

A: Metal



For Model	Size (mm) Dia x Thick x Bore	Grit	Max. RPM	Part No.
9105	125 x 19x12.7	A24P	5,090	741015-5
GS5000	125 x 20x12.7	A24P	5,660	B-33990
		A36P	5,660	B-34001
GS6000	150 x 50x12.7	A24P	5,660	B-34017
		A36P	5,660	B-34023

## Grinding Wheel for Bench Grinder

A: To grind mild steel, carbon steel, etc.  
 GC: Fine Aluminum, Copper, Brass  
 WA: Metal, Stainless Steel



For Model	Size (mm)	Grit	Max. RPM	Part No.
GB602	150 x 16	A36M	4,250	B-51904
		A60M	4,250	B-51910
		GC120H	4,250	B-51932
		WA60K		B-51926
9306S	150 x 6.4	A60M	4,250	A-47195
GB801	205 x 19	A36P		B-51948
		A60P	3,720	B-51954
		GC120H	3,720	B-51976
		WA60K		B-51960
GB600	150 x 19	A36Q	4,200	(GB)6005R
		A60P	4,200	(GB)6005L
GB601	150 x 25.4	A36Q	4,200	(GB)6105R
		A60P	4,200	(GB)6105L
GB800	205 x 25.4	A36Q	3,700	(GB)8005R
		A60P	3,700	(GB)8005L

## Eye shield for bench grinders

For Model	Part No.
GB800	(GB)8050

- DRILLING / FIXING
- CONCRETE DRILLING / DEMOLITION
- MIXING / STIRRING
- CUTTING (CONCRETE / METAL)
- GRINDING
- SANDING / POLISHING
- SAWING
- MULTI-TOOL
- ROUTERS / PLANERS
- NAILERS / STAPLERS
- HEAT GUN / LASER
- CLEANING
- OPE
- JOB SITE TOOLS
- SPECIALTY TOOLS
- HAND TOOLS / COMBINATION SET
- TOOL HOLDERS AND POUCHES / MAKPAC SYSTEM

- DRILLING / FIXING
- CONCRETE DRILLING / DEMOLITION
- MIXING / STIRRING

### Dust Cover Attachment



Suitable for	Type	Part No.
GA7020, GA7021, GA9020, GA7030/S, GA7040S, GA9030/S, GA9040S	A	194289-1
GA4050/R, GA4550/R, GA5050/R	B	199514-5
PC5010C		198719-4

- CUTTING (CONCRETE / METAL)
- GRINDING

### Dust Bag Assembly

For Concrete planer



Suitable for	Part No.
PC5000C, PC5001C	122853-8

- SANDING / POLISHING
- SAWING

### Dust collecting wheel guard for Diamond Cup Wheel

	Suitable For		Part No.
A	115, 125mm Angle Grinders with single notch on bearing box & PC5010C	A	195237-3
	115, 125mm XGT Angle Grinders and GA4550/R, GA5050/R	A	191F81-2
B	180mm, 230mm Angle Grinders with tripple notches	B	191X44-6

Brush Set for diamond cup wheel (For 115mm, 125mm Grinders): 196880-1

- MULTI-TOOL
- ROUTERS / PLANERS
- NAILERS / STAPLERS
- HEAT GUN / LASER
- CLEANING

### Dust collecting wheel guard

	Suitable For	Part No.
A	N9500N, 9500NB	192212-0 to be used with rubber sleeve 192202-3
	100mm Grinders	192475-8
B	115, 125mm Grinders with single notch on bearing box	196846-1
	115, 125mm Grinders with tripple notches on bearing box & PC5010C	196845-3
	115, 125mm XGT Grinders, GA4550/R, GA5050/R	191G06-2
C	115, 125mm X-Lock Grinders	191G05-4
	180mm Grinders	194303-3

- OPE
- JOBSITE TOOLS
- SPECIALTY TOOLS
- HAND TOOLS / COMBINATION SET
- TOOL HOLDERS AND POUCHES / MAKPAC SYSTEM

### Dust Collecting Wheel guard



Suitable For	Part No.
DGA900 and 230mm angle grinders with twin notches on bearing box	198380-7
GA037G and 180mm angle grinders with tripple notches on bearing box	198514-2
GA038G and 230mm angle grinders with tripple notches on bearing box	198440-5

### New tool-less wheel cover (Slide lever style)

For fast and easy angle adjustment and installation / removal of wheel cover  
(Currently available for XGT and X-Lock Grinders)

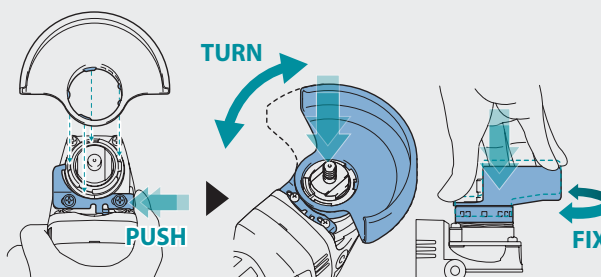

### Wheel guard

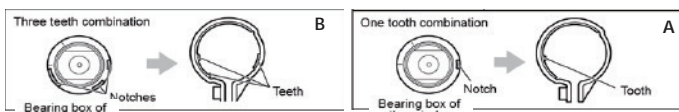

Suitable For	For Model	Bear Type	Type	Part No.
100mm Grinders	N9500N	B		154755-0
	9520B			165171-1
	9553HN, 9556HN, 9556HP	B		125266-2 / 122B50-8
	GA4030, GA4034, GA4040 GA4040C 9553HN, 9556HN, 9556HP	A		125885-4
	9563C, 9563HZ			135109-0
	GA4050/R		New Tool Less	347478-9
115mm Grinders	9521NB			165053-7
	9564H, 9564C, 9564CV, 9564P, 9554HN, 9557HN, 9557HP	B		125267-0
		B	Tool Less	135107-4
	GA4530 GA4534 GA4540 GA4540C, 9554HN, 9557HN, 9557HP, 9561CR, 9564H, 9564P, 9564PC, DGA452, DGA454, DGA455, DGA456, DGA458	A		123098-1
		A	Tool Less	123144-0
	X-LOCK		New Tool Less	162707-7
125mm Grinders	GA004G / 12G / 22G / 28G - XGT, GA4550/R		New Tool Less	347479-7
	9522NB, 9015B			125097-9
	9555HN, 9558HN, 9558HP, 9565HZ, 9562CR, 9565CV/CVL			125268-8
	GA5010 GA5020 GA5030, GA5040, GA5040C 9555HN, 9558HN, 9558HP, 9558NB, 9562CR, 9565C, 9565CLR, 9565CV 9565CVL 9565H 9565P 9565PC	A		122887-1
		A		123099-9
			Tool Less	135242-8
150mm Grinders	X-LOCK		New Tool Less	162708-5
	GA005G / 13G / 23G / 29G - XGT, GA5050/R		New Tool Less	347480-2
	GA6010	C		135192-7
180mm Grinders	GA036G, GA035G		New Tool Less	347776-1
	9607HB, GA7001			164825-7
	DGA700, GA7020, GA7030, GA7040S, GA7050, GA7063, GA7064, GA7080, GA7070	A		122889-7
230mm Grinders	GA037G		New Tool Less	127713-9
	9609HB			164814-2
	DGA900 GA9020, GA9030, GA9040S, GA9050, GA9063, GA9064, GA9070, GA9080 GA038G	A		122891-0
		New Tool Less	127714-7	

- DRILLING / FIXING
- CONCRETE DRILLING / DEMOLITION
- MIXING / STIRRING
- CUTTING (CONCRETE / METAL)
- GRINDING
- SANDING / POLISHING
- SAWING
- MULTI-TOOL
- ROUTERS / PLANERS
- NAILERS / STAPLERS
- HEAT GUN / LASER
- CLEANING
- OPE
- JOB SITE TOOLS
- SPECIALTY TOOLS
- HAND TOOLS / COMBINATION SET
- TOOL HOLDERS AND POUCHES / MAKPAC SYSTEM

DRILLING /  
FIXING

CONCRETE  
DRILLING /  
DEMOLITION

MIXING /  
STIRRING

CUTTING  
(CONCRETE /  
METAL)

GRINDING

SANDING /  
POLISHING

SAWING

MULTI-TOOL

ROUTERS /  
PLANERS

NAILERS /  
STAPLERS

HEAT GUN /  
LASER

CLEANING

OPE

JOBSITE  
TOOLS

SPECIALTY  
TOOLS

HAND TOOLS /  
COMBINATION SET

TOOL HOLDERS  
AND POUCHES /  
MAKPAC SYSTEM

## Grip



Grip



AVT Grip

Suitable for	Standard Grip	Rubberized Grip	Anti Vibration Grip
100, 115, 125mm Grinders, GA035G, GA036G	153489-2	158237-4	194514-0
GA4030, GA4034, GA4530, GA4534, GA5010, GA5011, GA6010	153504-2	158237-4	194514-0
9005B, 9005N, N9500N, 9015B, GA7001	152492-0		
GA7050, GA7050R, 9067, GA7020, GA9050, GA9050R, 9069, GA9020	152539-0		162264-5
GA9062, GA7062, GA9063, GA7063, DGA700, DGA900	143846-6		162264-5
GA9030, GA9040S, GA7030, GA7040S, GA0037G, GA0038G	-		162264-5
9005B	273503-9		

## Lock nut wrench

- Used with Grinders / Concrete Planers, Wall Chaser



For Model	Size	Part No.
100mm Grinders	20	782420-7
100mm Grinders / PC1100	20	782401-1
115 / 125 / 150mm Grinders	35	782423-1
150 / 180 / 230mm Grinders	35	782407-9
DIN / OLD Type	28	782412-6
PC5000C / PC5001C	35	782426-5

## Wrench

- Used with Die Grinders, Straight Grinders, Cutters, Wall Chaser



A

For model	Size	Type	Part No.
	10		781036-5
906 / 906H	17	A	781037-3
GD0600 / GD0602	13		781039-9
GD0800C / GD08010C	13		781203-2

## Lock nut release socket

- Used with Grinders



(Square drive :12.7mm)

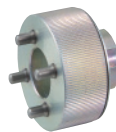

For Model	Size	Part No.
180 / 230mm Grinders	28	194305-9



# Sanding / Polishing

Disc Sander, Polisher, Angle Sander, Stone Polisher, Belt Sander, Wheel Sander, Finishing Sander, Orbital Sander, Random Orbit Sander



Cordless lineup to cover all polishing applications

DRILLING / FIXING

**PV001G : 180 mm**  
**40V MAX XGT**

**DPO600 : 150 mm**  
**18V LXT**

**DPV300 : 80 mm**  
**18V LXT**

**PV301D : 80 mm**  
**12V MAX CXT**

CONCRETE DRILLING / DEMOLITION

**PV001G** 180 mm **40V MAX | XGT**

**Cordless Polisher**



**Ideal for car painting business**

- PV001G has a wider constant-speed range than the competing model
- Maintain high rotation speed even under loaded condition by providing even polishing finish.
- Variable speed control dial with indication of max rotation speed
- Higher max rotation speed: For scratch removal with polishing compound
- Lower max rotation speed: For polishing curved portions or narrow spaces, or for finish polishing



Capacity	Pad: 180mm
No Load Speed (RPM)	0 - 2,200
Dimensions (L x W x H)	496 x 198 x 196 mm
Net weight	2.3 kg (without battery)

**Standard Equipment:** Loop Handle, Hex Wrench

AVAILABLE VARIANTS

4.0Ah	"Z" VARIANT
<b>PV001G M1</b> INCLUDES 1 BATTERY / 1 CHARGER / CARRY CASE	<b>PV001G Z</b> TOOL ONLY (DOES NOT INCLUDE BATTERY / CHARGER / CARRYING CASE)

MIXING / STIRRING

CUTTING (CONCRETE / METAL)

GRINDING

SANDING / POLISHING

SAWING

MULTI-TOOL

ROUTERS / PLANERS

NAILERS / STAPLERS

HEAT GUN / LASER

CLEANING

OPE

JOBSITE TOOLS

SPECIALTY TOOLS

HAND TOOLS / COMBINATION SET

TOOL HOLDERS AND POUCHES / MAKAPAC SYSTEM

**DPO600** 150 mm **18V | LXT**

**Cordless Random Orbit Polisher**



**High power similar to AC tool achieved by High power Brushless Motor**

- Selectable two rotation mode: normal mode for rough polishing & finishing mode for fine polishing

**Rough Polishing**

**Forcible rotation mode**

Orbital action with forced rotation of the pad for rough polishing such as scratch removal.



**Fine Polishing**

**Free rotation mode**

Orbital action with free rotation of the pad for fine polishing.



Pad Size	150 mm (6")
Orbits Per Minute (OPM)	Normal mode: 0 - 6,800 / Finishing mode: 0 - 5,300
Strokes Per Minute (SPM)	Normal mode: 0 - 13,600 / Finishing mode: 0 - 10,600
No Load Speed (RPM)	Normal mode: 0 - 780 / Finishing mode: 0 - 610
Orbit Diameter	5.5 mm (7/32")
Dimensions (L x W x H)	530x123x128 mm
Net weight	3.6 kg

**Standard Equipment:** Rubber pad, grip

AVAILABLE VARIANTS

5.0Ah	"Z" VARIANT
<b>DPO600 RTE</b> 2 BATTERIES / 1 CHARGER / TOOL BAG	<b>DPO600 Z</b> TOOL ONLY (DOES NOT INCLUDE BATTERY / CHARGER OR TOOL BAG)

**PV301D** 80 mm **12V MAX | CXT**

**Cordless Sander Polisher**

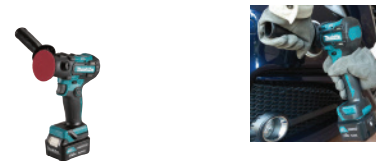

**Compact design for comfortable use in narrow work spaces**

- Large capacity of 80mm for polishing and 50mm for sanding in compact size body
- 2 speed selection Polishing: 0 - 2800 and Sanding: 0 - 9500
- Elastomer bumper on gear housing for work piece protection
- Dust cover minimizes the ingress of wool dust when buffing with a wool pad
- Lock-on switch reduces hand fatigue in long continuous operation
- Trigger lock minimizes accidental start-up during transportation



Pad / Disc Diameter	Twist-On / Twist-Off Style: 50 mm (2") Hook & Loop Style: 80 mm (3-1/8")
Backing Pad Diameter	Twist-On / Twist-Off Style: 46 mm (1-13/16") Hook & Loop Style: 75 mm (2-15/16")
No Load Speed (RPM)	Polishing: 0 - 2,800 / Sanding: 0 - 9,500
Continuous Use (min.)	w/ BL1041B: 18mins
Head Length	127 mm (5")
Dimensions (L x W x H)	137 x 67 x 231 mm
Net weight	1.2 kg (with 4.0Ah battery)

**Standard Equipment:** Side Grip

AVAILABLE VARIANTS

"Z" Version
<b>PV301D Z</b> TOOL ONLY (DOES NOT INCLUDE BATTERY / CHARGER / CARRYCASE)

**PO6000C** 150 mm (6") 

**Random Orbit Polisher**



**Selectable two rotation mode: Random orbit with forced rotation mode for rough polishing & Random orbit mode for fine polishing**

- Random orbit with forced rotation mode is orbital action with forced rotation of the pad for rough polishing such as surface treatment
- Random orbit mode is orbital action with free rotation of the pad for fine polishing
- Setting up RPM in the full speed is easy by a variable speed dial



<b>Continuous rating input</b>	900W
<b>Pad Size</b>	150 mm (6")
<b>Orbits Per Minute (OPM)</b>	0 - 6,800
<b>Strokes Per Minute (SPM)</b>	0 - 13,600
<b>No Load Speed (RPM)</b>	0 - 780
<b>Orbit Diameter</b>	5.5 mm (7/32")
<b>Vibration Level</b>	Polishing: 7.0 m/s <sup>2</sup>
<b>Sound Pressure Level</b>	83 dB(A)
<b>Sound Power Level</b>	94 dB(A)
<b>Dimensions (L x W x H)</b>	451x148x126 mm (17-3/4"x5-7/8"x5")
<b>Net weight</b>	2.8 kg (6.2 lbs)
<b>Power supply cord</b>	4.0 m (13.1 ft)

**Standard Equipment:** Side grip, Hex Wrench

**9237CB** 180mm (7") 

**Polisher**



**Loop handle with rubberized soft grip.**

- Variable speed control by dial Rotation speed is adjustable to application.
- Vent dust cover of screw-down type prevents ingress of wool fibers.
- Elastomer bumper on gear housing protects a precious surface, such as that of car body, from damage and scratches



<b>Continuous rating input</b>	1,200W
<b>Capacity</b>	Wool Pad: 180 mm (7") Wool Bonnet: 180 mm (7")
<b>No Load Speed (RPM)</b>	0 - 3,200
<b>Vibration Level</b>	2.5 m/s <sup>2</sup> or less
<b>Sound Pressure Level</b>	83 dB(A)
<b>Sound Power Level</b>	94 dB(A)
<b>Dimensions (L x W x H)</b>	431x198x187 mm (17"x7-3/4"x7-3/8")
<b>Net weight</b>	3.4 kg (7.5 lbs.)
<b>Power supply cord</b>	2.5 m (8.2 ft)

**Standard Equipment:** Loop handle, Hex wrench

**PV7000C** 180mm (7") 

**Polisher**



**Compact body with low center of gravity for absolutely controlled operation and reduced fatigue**

- Electronic control for consistent speed
- 2 speed plus variable speed control for a wide range of polishing works
- Pre-setting speed control dial
- Durable cord guard
- Quick-flip speed change for compounding and polishing



<b>Continuous rating Input</b>	900W
<b>Capacity</b>	Abrasive disc : 180mm (7") Pad : 170mm (6-11/16")
<b>No load speed</b>	600-2,000rpm
<b>Overall length</b>	210mm (8-1/4")
<b>Net weight</b>	2.1kg (4.6lbs)
<b>Power supply cord</b>	2.5m (8.2ft)

**Standard Equipment:** Wrench, Side Grip

**9218PB** 180mm (7") 

**Polisher**

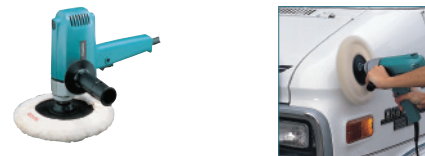

**Better polishing action for a wide range of applications**

- Easy handling to reduced operator fatigue



<b>Continuous rating Input</b>	570W
<b>Capacity</b>	Wool bonnet : 180mm (7")
<b>No load speed</b>	2,000rpm
<b>Overall length</b>	235mm (9-1/4")
<b>Net weight</b>	2.7kg (5.9lbs)
<b>Power supply cord</b>	2.5m (8.2ft)

**Standard Equipment:** Lock Nut Wrench, Grip

- DRILLING / FIXING
- CONCRETE DRILLING / DEMOLITION
- MIXING / STIRRING
- CUTTING (CONCRETE / METAL)
- GRINDING
- SANDING / POLISHING
- SAWING
- MULTI-TOOL
- ROUTERS / PLANERS
- NAILERS / STAPLERS
- HEAT GUN / LASER
- CLEANING
- OPE
- JBSITE TOOLS
- SPECIALTY TOOLS
- HAND TOOLS / COMBINATION SET
- TOOL HOLDERS AND POUCHES / MAKPAC SYSTEM

DRILLING / FIXING

CONCRETE DRILLING / DEMOLITION

MIXING / STIRRING

CUTTING (CONCRETE / METAL)

GRINDING

SANDING / POLISHING

SAWING

MULTI-TOOL

ROUTERS / PLANERS

NAILERS / STAPLERS

HEAT GUN / LASER

CLEANING

OPE

JOBSITE TOOLS

SPECIALTY TOOLS

HAND TOOLS / COMBINATION SET

TOOL HOLDERS AND POUCHES / MAKPAC SYSTEM

**9207SPB** 180mm (7") 

**Sander-Polisher**



**2-speed (2,000rpm & 3,800rpm) for use as a sander or polisher**

- Packs Makita's basic concepts of a sander-polisher



<b>Continuous rating Input</b>	700W
<b>Capacity</b>	Abrasive disc : 180mm (7") Diamond wheel : 180mm (7")
<b>No load speed</b>	2,000 / 3,800rpm
<b>Overall length</b>	455mm (17-7/8")
<b>Net weight</b>	3.4kg (7.5lbs)
<b>Power supply cord</b>	2.5m (8.2ft)

**Standard Equipment:** Lock Nut Wrench, Grip

**SA7000C** 180mm (7") 

**Angle Sander**



**Powerful 1,600W motor delivers outstanding performance for industrial use**

- Motor has outstanding heat resistance to protect from overheating
- Speed control dial allows you to adjust maximum speed in 6 stages from 1,500 to 4,000rpm
- Variable speed trigger switch for controlled sanding.
- Lightweight, reducing operator fatigue in continuous use.



<b>Continuous rating Input</b>	1,600W
<b>Capacity</b>	Abrasive disc : 180mm (7") Pad : 180mm (7")
<b>No load speed</b>	0-4,000rpm
<b>Dimensions</b>	453mm x 170mm x 136mm (17-7/8" x 6-11/16" x 5-3/8")
<b>Net weight</b>	3.4kg (7.5lbs)
<b>Power supply cord</b>	2.5m (8.2ft)

**Standard Equipment:** Lock Nut Wrench 35, Grip

**SA7021** 

**Angle Sander**



**Outstanding durability**

- Increased heat resistance.
- Superior anti-dust structure.
- Machined bevel gear for strength.
- Soft grip for more comfort and control.
- Gear housing can be positioned at every 90 degrees



<b>Continuous rating Input</b>	2,200W
<b>Capacity</b>	Depressed center wheel : 180, 230mm (7, 9") Abrasive disc : 180mm (7")
<b>No load speed</b>	6,600rpm
<b>Dimensions (L x W x H)</b>	473 x 105 x 140mm (18-5/8" x 4-1/8" x 5-1/2")
<b>Net weight</b>	5.0kg (11.1lbs)
<b>Power supply cord</b>	2.5m (8.2ft)

**Standard Equipment:** Lock Nut Wrench, Grip

## Disc Sander



### GV6010 150mm (6")

Acc Pg. A129 64

#### Disc Sander



#### Improved cooling airflow

- Ergonomically designed handle with rubberized soft grip



Continuous rating Input	440W
Capacity	Abrasive disc :150mm (6") Pad : 120mm (4-3/4")
No load speed (rpm)	4,500
Dimensions (L x W x H)	200 x 74 x 181mm (7-7/8" x 2-15/16" x 7-1/8")
Net weight	1.2kg (2.6lbs)
Power supply cord	2.5m (8.2ft)

Standard Equipment: Hex Wrench, Grip

### 9218SB 180mm (7")

#### Disc Sander



#### Well-balanced body for fast and steady sanding

- Lock-on button for continuous use and reduced operator fatigue.



Continuous rating Input	570W
Capacity	Wire cup brush : 110mm (4-3/8") Abrasive disc : 180mm (7")
No load speed	4,500rpm
Overall length	225mm (8-7/8")
Net weight	2.9kg (6.3lbs)
Power supply cord	2.5m (8.2ft)

Standard Equipment: Lock Nut Wrench, Grip.

### GV7000C 180mm (7")

#### Disc Sander



#### Compact body with low center of gravity for absolutely controlled operation and reduced fatigue

- Lock-on button for continuous use
- Variable speed control plus Electronic control



Continuous rating Input	900W
Capacity	Abrasive disc : 180mm (7") Pad : 180mm (7")
No load speed	2,500-4,700rpm
Overall length	210mm (8-1/4")
Net weight	2.1kg (4.6lbs)
Power supply cord	2.5m (8.2ft)

Standard Equipment: Lock Nut Wrench, Grip

DRILLING / FIXING

CONCRETE DRILLING / DEMOLITION

MIXING / STIRRING

CUTTING (CONCRETE / METAL)

GRINDING

SANDING / POLISHING

SAWING

MULTI-TOOL

ROUTERS / PLANERS

NAILERS / STAPLERS

HEAT GUN / LASER

CLEANING

OPE

JOBSITE TOOLS

SPECIALTY TOOLS

HAND TOOLS / COMBINATION SET

TOOL HOLDERS AND POUCHES / MAKPAC SYSTEM

DRILLING / FIXING

CONCRETE DRILLING / DEMOLITION

MIXING / STIRRING

CUTTING (CONCRETE / METAL)

GRINDING

SANDING / POLISHING

SAWING

MULTI-TOOL

ROUTERS / PLANERS

NAILERS / STAPLERS

HEAT GUN / LASER

CLEANING

OPE

JOBSITE TOOLS

SPECIALTY TOOLS

HAND TOOLS / COMBINATION SET

TOOL HOLDERS AND POUCHES / MAKPAC SYSTEM

## Belt Sander



## DBS180

18V | LXT

### Cordless Belt Sander



#### High power BL motor provides excellent performance similar to corded tool

- Compact design with a short height
- Excellent performance as powerful as AC model gives high productivity.
- Adjustable sanding arm 160° for easy handling
- Lightweight and Connectable to vacuum cleaners



<b>Belt Width</b>	6 / 9 / 13 mm (1/4 / 3/8 / 1/2")
<b>Belt Length</b>	533 mm
<b>Belt Speed</b>	600 - 1,700 m/min
<b>Vibration Level</b>	2.5 m/s <sup>2</sup> or less
<b>Sound Pressure Level</b>	77 dB(A)
<b>Dimensions (L x W x H)</b>	500x96x116 mm
<b>Net weight</b>	2.1 kg

**Standard Equipment:** Grip

#### AVAILABLE VARIANTS

##### "Z" VARIANT

**DBS180 Z**  
TOOL ONLY  
(DOES NOT INCLUDE BATTERY / CHARGER OR CARRY CASE)

## 9032 9mm X 533mm



### Belt Sander



#### Max. sanding depth 110 mm

- Adjustable sanding arm pivots 100 degrees for hard to reach areas
- Electronic speed control dial for fine work
- Easily adjustable belt tracking with a turn of the knob
- Dust-free work with Makita dust collection system
- Optional 6mm and 13mm sanding bars for a wide range of sanding and filing jobs



<b>Continuous rating Input</b>	500W
<b>Belt size</b>	9 x 533mm (3/8" x 21")
<b>Belt speed</b>	300 - 1,700m / min. (980 - 5,600ft/ min)
<b>Max. sanding depth</b>	110mm (4-5/16")
<b>Overall length</b>	420mm (16-1/2")
<b>Net weight</b>	1.6kg (3.5lbs)
<b>Power supply cord</b>	2.5m (8.2ft)

## 9031 30mm x 533mm (1-3/16" x 21")



### Belt Sander



#### Optimum for use in close quarters or on irregular shapes

- Belt speed can be adjusted for sanding a wide variety of materials
- Multi-position side handle for easy and comfortable operation.
- Lock-on button for continuous operation



<b>Continuous rating Input</b>	550W
<b>Belt size</b>	30 x 533mm (1-3/16" x 21")
<b>Belt speed</b>	200 - 1,000m / min. (656 - 3,280ft/ min)
<b>Overall length</b>	380mm (15")
<b>Net weight</b>	2.1kg (4.6lbs)
<b>Power supply cord</b>	2.5m (8.2ft)

**9910** 76mm x 457mm (3" x 18")



**Belt Sander**



**Compact and well balanced for easy operation**

- Unique design allows flush sanding to a wall.
- Flat top design allows sander to be turned and used as a bench top tool.
- Low noise at only 82dB for quieter operation.
- Auto-tracking belt system requires no adjustment after in stalling belt



<b>Continuous rating Input</b>	650W
<b>Belt size</b>	76 x 457mm (3" x 18")
<b>Belt speed</b>	270m / min. (900ft/ min)
<b>Overall length</b>	262mm (10-5/16")
<b>Net weight</b>	2.7kg (6.0lbs)
<b>Power supply cord</b>	2.5m (8.2ft)

**Standard Equipment:** Dust bag assembly

**9924DB** 76mm x 610mm (3" x 24")



**Belt Sander**



**Sufficient power, proven reliability and wellbalanced design : pro's choice for years**

- Extended base to allow flush sanding.
- Replaceable ceramic wear-plate for easy maintenance.
- Easy lever control to change belts



<b>Continuous rating Input</b>	850W
<b>Belt size</b>	76 x 610, 620mm (3" x 24, 24-3/8")
<b>Belt speed</b>	400m / min. (1,300ft/ min)
<b>Overall length</b>	355mm (14")
<b>Net weight</b>	4.8kg (10.6lbs)
<b>Power supply cord</b>	5.0m (16.4ft)

**Standard Equipment:** Dust bag assembly

**9920** 76mm x 610mm (3" x 24")



**Belt Sander**



**Features auto-tracking belt system, high dust collecting capacity, low noise at only 85dB**

- Flush sanding possible
- Electronic variable speed control feature



<b>Continuous rating Input</b>	1,010W
<b>Belt size</b>	76 x 610mm (3" x 24")
<b>Belt speed</b>	210 - 440m / min. (690 - 1,440ft/ min)
<b>Overall length</b>	334mm (13-1/8")
<b>Net weight</b>	4.5kg (9.9lbs)
<b>Power supply cord</b>	5.0m (16.4ft)

**Standard Equipment:** Dust bag assembly

**9401** 100mm x 610mm (4" x 24")



**Belt Sander**



**Perfect for flush-along-side sanding as well as open areas**

- Highly-efficient dust collection system for clean work environment.
- Low center of gravity makes sander ideally balanced for superior handling.



<b>Continuous rating Input</b>	940W
<b>Belt size</b>	100mm x 610mm (4" x 24")
<b>Belt speed</b>	350m / min. (1,150ft/ min)
<b>Overall length</b>	374mm (14-3/4")
<b>Net weight</b>	7.4kg (16.3lbs)
<b>Power supply cord</b>	5.0m (16.4ft)

**Standard Equipment:** Dust Bag Assembly

DRILLING / FIXING

CONCRETE DRILLING / DEMOLITION

MIXING / STIRRING

CUTTING (CONCRETE / METAL)

GRINDING

SANDING / POLISHING

SAWING

MULTI-TOOL

ROUTERS / PLANERS

NAILERS / STAPLERS

HEAT GUN / LASER

CLEANING

OPE

JOBSITE TOOLS

SPECIALTY TOOLS

HAND TOOLS / COMBINATION SET

TOOL HOLDERS AND POUCHES / MAKPAC SYSTEM

DRILLING /  
FIXING

CONCRETE  
DRILLING /  
DEMOLITION

MIXING /  
STIRRING

CUTTING  
(CONCRETE /  
METAL)

GRINDING

SANDING /  
POLISHING

SAWING

MULTI-TOOL

ROUTERS /  
PLANERS

NAILERS /  
STAPLERS

HEAT GUN /  
LASER

CLEANING

OPE

JOBSITE  
TOOLS

SPECIALTY  
TOOLS

HAND TOOLS /  
COMBINATION SET

TOOL HOLDERS  
AND POUCHES /  
MAKPAC SYSTEM

**9403** 100mm x 610mm (4" x 24")



**Belt Sander**



**Powerful 1,200W motor for high production use**

- Quietest belt sander in its class (84dB).
- 500 m/min belt speed for fast material removal.
- Labyrinth construction seals motor and bearings from contamination.
- Dust bag swivels 360 degrees for convenience



Continuous rating Input	1,200W
Belt size	100mm x 610mm (4" x 24")
Belt speed	500m / min. (1,640ft/ min)
Overall length	353mm (13-7/8")
Net weight	5.7kg (12.6lbs)
Power supply cord	5.0m (16.4ft)

**Standard Equipment:**Dust Bag Assembly

**9404** 100mm x 610mm (4" x 24")



**Belt Sander**



**Features auto-tracking belt system, high dust collecting capacity, low noise at only 85dB**

- Unique design allows flush sanding to a wall with side of sander
- Electronic variable speed control feature



Continuous rating Input	1,010W
Belt size	100 mm x 610mm (4" x 24")
Belt speed	210 - 440m / min. (660 - 1,440ft./ min)
Overall length	334mm (13-1/8")
Net weight	4.7 kg (10.6lbs)
Power supply cord	5.0m (16.4ft)

**Standard Equipment:** Dust Bag Assembly

**Wheel Sander**



**9741**



**Wheel Sander**



**Unique sanding solution for variety of materials**

- Brings out beautiful wood grain with nylon brush wheel.
- For fast and efficient paint and rust removal with optional wheels.
- Well balanced design with a low center of gravity and large front loop handle for easy handling.
- Connects to a dust collector for cleaner operation



Continuous rating Input	860W
Wheel dia.	100 x 120mm (4 x 4-3/4")
No load speed	3,500rpm
Overall length	310mm (12-1/4")
Net weight	4.2kg (9.3lbs)
Power supply cord	5.0m (16.4ft)

**Standard Equipment:** Hex Wrenches



## Random Orbit Sander / Finishing Sander



DBO180 125mm (5")

18V | LXT

### Cordless Random Orbit Sander



#### Excellent performance with high orbital speed.

- Compact design with a short height and a lower center of gravity easily handle.
- Excellent performance as powerful as AC model gives high productivity.
- Ergonomically best possible grip plus compact tool design.
- Connectable to Makita vacuum cleaners without adapter



Pad diameter	123mm (4-7/8")
Abrasive disc diameter	125mm (5")
Orbits per minute (opm)	7,000/ 9,500/ 11,000
Dimensions (L x W x H)	175x123x153mm (6-7/8"x4-7/8"x6")
Net weight	1.7kg (3.6lbs)

**Standard Equipment:** Dust bag or dust box

#### AVAILABLE VARIANTS

##### "Z" VARIANT

**DBO180 Z**  
TOOL ONLY  
(DOES NOT INCLUDE BATTERY / CHARGER OR CARRY CASE)

BO5030



### Random Orbit Sander



#### Powerful 300W motor and high durability

- Ergonomically designed rubberized top-cover and body provide more control and comfort.
- Rubber switch cover prevents ingress of dust.
- Convenient pad brake for fast stop.



Continuous rating Input	300W
Pad diameter	123mm (4-7/8")
Abrasive disc diameter	125mm (5")
Orbits per minute (opm)	12,000
Dimensions (L x W x H)	153 x 123 x 153mm (6" x 4-7/8" x 6")
Net weight	1.3kg (2.9lbs)
Power supply cord	2.0m (6.6ft)

**Standard Equipment:** Dust Box

BO5041

### Random Orbit Sander



#### Ergonomically designed body and rotatable front grip provides more control and comfort.

- High power motor.
- High durability by large size of ball bearing.
- Built-in dust extraction.
- High dust extraction rate.
- Speed control dial.



Continuous rating Input	300W
Pad diameter	123mm (4-7/8")
Abrasive disc diameter	125mm (5")
Orbits per minute (opm)	4,000-12,000
Dimensions (L x W x H)	218 x 123 x 153mm (8-5/8" x 4-7/8" x 6")
Net weight	1.4kg (3.1lbs)
Power supply cord	2.0m (6.6ft)

**Standard Equipment:** Dust Box

DRILLING / FIXING

CONCRETE DRILLING / DEMOLITION

MIXING / STIRRING

CUTTING (CONCRETE / METAL)

GRINDING

SANDING / POLISHING

SAWING

MULTI-TOOL

ROUTERS / PLANERS

NAILERS / STAPLERS

HEAT GUN / LASER

CLEANING

OPE

JOBSITE TOOLS

SPECIALTY TOOLS

HAND TOOLS / COMBINATION SET

TOOL HOLDERS AND POUCHES / MAKPAC SYSTEM

DRILLING / FIXING

**BO6030** 

**Random Orbit Sander**



**Exceptionally low vibration, yet aggressive sanding**

- Through-the-pad dust collection system for a cleaner job site.
- Ergonomic handles for controlled operation.
- Pad control system prevents gouging.
- Variable speed control dial to match the sanding speed to the material.



<b>Continuous rating input</b>	310W
<b>Pad diameter</b>	150mm (6")
<b>Abrasive disc diameter</b>	150mm (6")
<b>Orbits per min.</b>	4,000-10,000 opm
<b>Overall length</b>	309mm (12-1/8")
<b>Orbit diameter</b>	3.0mm (1/8")
<b>Net weight</b>	2.4kg (5.2lbs)
<b>Power supply cord</b>	2.5m (8.2ft)

**Standard Equipment:** Hex Wrench, Dust Bag.

CONCRETE DRILLING / DEMOLITION

MIXING / STIRRING

CUTTING (CONCRETE / METAL)

GRINDING

SANDING / POLISHING

SAWING

MULTI-TOOL

ROUTERS / PLANERS

NAILERS / STAPLERS

HEAT GUN / LASER

CLEANING

OPE

JOBSITE TOOLS

SPECIALTY TOOLS

HAND TOOLS / COMBINATION SET

TOOL HOLDERS AND POUCHES / MAKPAC SYSTEM

**BO6050J** 

**Random Orbit Sander**



**150mm (6") random orbit sander with excellent operability**

- Ergonomically designed palm grip with elastomer
- Toolless pad change; enables quick pad change to suit application.

**2 mode operation**

**a) Traditional random orbit mode**

For fine finish sanding and buffing

**b) The alternative roto-orbit mode**

Ideal for stock removal, coarse sanding and polishing.



<b>Continuous rating input</b>	750W
<b>Pad diameter</b>	150mm (6")
<b>Abrasive disc diameter</b>	150mm (6")
<b>Orbits per minute (opm)</b>	1,600 - 6,800
<b>Sanding strokes per minute (spm)</b>	3,200 - 13,600
<b>Pad speed in Roto-orbit mode (rpm)</b>	140 - 600
<b>Orbit diameter</b>	5.5mm (7/32")
<b>Dimensions (L x W x H)</b>	330x155x145mm (13"x6-1/8"x5-3/4")
<b>Net weight</b>	2.6kg (5.7lbs)
<b>Power supply cord</b>	2.5m (8.2ft)

**Standard Equipment:** Abrasive disc, Dust nozzle, Side grip, Pad protector, Makpac case

**DBO482 1/4 Sheet** **18V | LXT**

**Cordless Finishing Sander**



**Low vibration & high power**

- 14,000 OPM for fast and smooth finish sanding
- Speed control by push button
- Easy-to-operate paper clamp
- Compatible with Triangle plate and Rectangle plate (optional)



<b>Pad Size</b>	112 x 102 mm (4-3/8 x 4")
<b>Abrasive Paper Size</b>	Rectangular: 114 x 140 mm (4-1/2 x 5-1/2")
<b>Orbits Per Minute (OPM)</b>	14,000
<b>Dimensions (L x W x H)</b>	156 x 112 x 151 mm
<b>Net weight</b>	1.0 kg (without battery)

**Standard Equipment:** Dust bag

AVAILABLE VARIANTS

5.0Ah	"Z" VARIANT
<b>DBO482 RTJ</b> 2 BATTERIES / 1 CHARGER IN MAKPAC CASE	<b>DBO482 Z</b> TOOL ONLY (DOES NOT INCLUDE BATTERY / CHARGER OR CARRY CASE)

**DBO380 1/3 Sheet** **18V | LXT**

**Cordless Finishing Sander**



**BL motor delivers high work efficiency**

- Both motor and battery are located above the sanding face to suppress fluttering of the base, enabling to provide an evenly finished surface
- Front grip is detachable without tools for corner sanding Speed control by push button
- 185 x 92mm pad size with spring loaded paper clamp
- 2.0mm orbit diameter for efficient removal of work piece material
- Connectable to Makita vacuum cleaners



<b>Pad Size</b>	93 x 185 mm (3-5/8 x 7-1/4")
<b>Abrasive Paper Size</b>	Rectangular: 93 x 228 mm (3-5/8 x 9")
<b>Orbits Per Minute (OPM)</b>	4,000, 8,000, 12,000
<b>Dimensions (L x W x H)</b>	336 x 92 x 169 mm
<b>Net weight</b>	1.5 kg (without battery)

**Standard Equipment:** Dust bag, Battery Protector

AVAILABLE VARIANTS

5.0Ah	"Z" VARIANT
<b>DBO380 RTJ</b> 2 BATTERIES / 1 CHARGER / MAKPAC CASE	<b>DBO380 Z</b> TOOL ONLY (DOES NOT INCLUDE BATTERY / CHARGER OR CARRY CASE)

**DBO381** 1/3 Sheet18V | **LXT****Cordless Finishing Sander (with AWS)****BL motor delivers high work efficiency**

- Both motor and battery are located above the sanding face to suppress fluttering of the base, enabling to provide an evenly finished surface
- Front grip is detachable without tools for corner sanding Speed control by push button
- 185 x 92mm pad size with spring loaded paper clamp
- 2.0mm orbit diameter for efficient removal of work piece material
- Auto-start Wireless System (AWS) bluetooth connection with compatible vacuum



<b>Pad Size</b>	93 x 185 mm (3-5/8" x 7-1/4")
<b>Abrasive Paper Size</b>	Rectangular: 93 x 228 mm (3-5/8" x 9")
<b>Orbits Per Minute (OPM)</b>	4,000, 8,000, 12,000
<b>Dimensions (L x W x H)</b>	336 x 92 x 169 mm
<b>Net weight</b>	1.5 kg (without battery)

**Standard Equipment:** Dust bag, Battery Protector

## AVAILABLE VARIANTS

## 5.0Ah

## "Z" VARIANT

**DBO381 RTJU**  
2 BATTERIES / 1 CHARGER / BULETOOTH  
CHIP / MAKPAC CASE

**DBO381 ZU**  
TOOL ONLY WITH BULETOOTH CHIP  
(DOES NOT INCLUDE BATTERY / CHARGER OR CARRY CASE)

**BO3700****Finishing Sander****Features efficient through-the-pad dust collection system**

- Ergonomically designed tool-top, comfortable control even with one-hand.
- Large levers for quick and easy changing of paper.
- Large trigger switch for easy operation.



<b>Continuous rating Input</b>	180W
<b>Pad size</b>	93mm x 185 mm (3-5/8" x 7-1/4")
<b>Abrasive paper size</b>	93mm x 228mm (3-5/8" x 9")
<b>Orbits per min.</b>	10,000 opm
<b>Overall length</b>	254mm (10")
<b>Net weight</b>	1.4kg (3.1lbs)
<b>Power supply cord</b>	2.0m (6.6ft)

**Standard Equipment:** Dust Box**BO3710****Finishing Sander****Ergonomic tool body fits user's hand perfectly, providing sure grip and easy handling whether in single- or double-handed operation**

- Durable aluminium foot with dust protection
- Powerful heavy-duty motor featuring increased power input obtained by redesigned cooling system
- Easy-to-operate paper clamp with large clamp lever ensures quick and easy paper replacement



<b>Continuous rating Input</b>	190W
<b>Pad size</b>	92 x 185mm (3-5/8" x 7-1/4")
<b>Abrasive paper size</b>	93 x 228mm (3-5/8" x 9")
<b>Orbits per minute (opm)</b>	11,000
<b>Dimensions (L x W x H)</b>	253 x 92 x 153mm (10" x 3-5/8" x 6")
<b>Net weight</b>	1.6kg (3.5lbs)
<b>Power supply cord</b>	2.0m (6.6ft)

**Standard Equipment:** Dust Box**BO4900****Finishing Sander****1/2 Sheet 330 W Finishing Sander**

- Through-the-Pad Dust Collection System
- Uses commonly available 115 mm x 232 mm hook-and-loop or 4-1/2" x 11" half sheet abrasive paper
- Efficient through-the-pad dust collection system for a cleaner work environment
- Minimized vibration and contoured grips for added comfort
- Large trigger switch for easier operation



<b>Continuous rating Input</b>	330W
<b>Pad size</b>	115mm x 229 mm (4-1/2" x 9")
<b>Abrasive paper size</b>	115mm x 232mm (4-1/2" x 9-1/8")
<b>Orbits per min.</b>	10,000 opm
<b>Overall length</b>	289mm (11-3/8")
<b>Net weight</b>	2.7kg (6.0lbs)
<b>Power supply cord</b>	2.5m (8.2ft)

**Standard Equipment:** Dust BagDRILLING  
/ FIXINGCONCRETE  
DRILLING /  
DEMOLITIONMIXING /  
STIRRINGCUTTING  
(CONCRETE /  
METAL)

GRINDING

SANDING /  
POLISHING

SAWING

MULTI-TOOL

ROUTERS /  
PLANERSNAILERS /  
STAPLERSHEAT GUN /  
LASER

CLEANING

OPE

JOBSITE  
TOOLSSPECIALTY  
TOOLSHAND TOOLS /  
COMBINATION SETTOOL HOLDERS  
AND POUCHES /  
MAKPAC SYSTEM

DRILLING / FIXING

CONCRETE DRILLING / DEMOLITION

MIXING / STIRRING

CUTTING (CONCRETE / METAL)

GRINDING

SANDING / POLISHING

SAWING

MULTI-TOOL

ROUTERS / PLANERS

NAILERS / STAPLERS

HEAT GUN / LASER

CLEANING

OPE

JOBSITE TOOLS

SPECIALTY TOOLS

HAND TOOLS / COMBINATION SET

TOOL HOLDERS AND POUCHES / MAKPAC SYSTEM

**BO4901** 

**Finishing Sander**



**1/2 Sheet 330 W Finishing Sander**  
**Minimized vibration for reduced operator fatigue**

- Minimized vibration level for reduced operator fatigue
- Ergonomic handles for absolutely controlled operation
- Large clamp lever for easy install / removal of paper
- Through-the-pad dust collection with Makita vacuum cleaner
- Efficient through-the-pad dust collection system for a cleaner work environment



Continuous rating Input	330W
Pad size	115mm x 229 mm (4-1/2" x 9")
Abrasive paper size	115mm x 280mm (4-1/2" x 11")
Orbits per min.	10,000 opm
Overall length	289mm (11-3/8")
Net weight	2.7kg (6.0lbs)
Power supply cord	2.5m (8.2ft)

**9046** 

**Orbital Sander**



**Powerful 600W performer for professional's needs**

- Accepts standard abrasive paper; as well as hook & loop abrasive paper.



Continuous rating input	600W
Pad dia.	115 mm x 229 mm (4-1/2" x 9")
Abrasive paper size	115 mm x 280 mm (4-1/2" x 11")
Orbits per min.	6,000 opm
Overall length	283 mm (11-1/8")
Orbit diameter	5 mm (3/16")
Net weight	3.1 kg (6.8 lbs)
Power supply cord	2.5 m (8.2 ft)

Standard Equipment: Dust Bag.

**BO4556** 

**Finishing Sander**



**Powerful 200W motor, low vibration, low noise**

- Powerful 200W motor.
- Easy installation/removal of paper with rolled clamber's edges.
- Rubber switch cover prevents ingress of dust.
- Ergonomically contoured grip with non-skid elastomer covered surface.
- Durable aluminum foot with dust protection



Continuous rating Input	200W
Pad size	112 x 102mm (4-3/8" x 4")
Abrasive paper size	114 x 140mm (4-1/2" x 5-1/2")
Dimensions (L x W x H)	131 x 112 x 141mm (5-1/8" x 4-3/8" x 5-9/16")
Orbits per minute	14,000 opm
Net weight	1.1kg (2.5lbs)
Power supply cord	2.0m (6.6ft)

Standard Equipment: Dust Bag.

**BO4566** 

**Finishing Sander**



**Superb sanding of blinds, louvers and shutters**

- Powerful motor.
- Ergonomically contoured grip with non-skid elastomer covered surface.
- Rubber switch cover prevents ingress of dust.
- Built-in dust extraction.
- Durable aluminum foot with dust protection



Continuous rating Input	200W
Pad size	100 x 164mm (3-15/16" x 6-1/2")
Abrasive paper size	102 x 166mm (4" x 6-1/2")
Orbits per minute (opm)	14,000
Dimensions (L x W x H)	197 x 100 x 137mm (7-3/4" x 3-15/16" x 5-3/8")
Net weight	1.2kg (2.6lbs)
Power supply cord	2.0m (6.6ft)

Standard Equipment: Dust Box.



## Dry wall Sander

DSL800

18V | **LXT**

### Cordless Drywall Sander



Continuous runtime

**35min**

Speed adjusting dial: 3  
Abrasive discs: #120  
Battery: BL1850B

- Flush-to-wall edge sanding with linear brush
- Direct Drive Brushless motor for increased efficiency

- A vacuum hose runs throughout the interior of the tool with a dust port at the base of the tool for use with a dust extractor for dust free sanding
- Overload sensor is designed to alert when excessive load is applied and protect from damage due to overheat
- The adjustable extension pipe for sanding in confined spaces, such as closets, and extends from 1,100mm to 1,520mm" for reaching high walls and ceilings.



Pad diameter	210 mm
Abrasive Disc Size	225 mm
No Load Speed (RPM)	1,000 - 1,800
Sound Pressure Level	75 dB(A)
Vibration Level	2.5 m/s <sup>2</sup> or less
Dimensions (L x W x H)	1,100-1,520x259x273 mm
Net weight	5.7 kg

Standard Equipment: Hex Wrench, Tool bag, Wireless Unit

#### AVAILABLE VARIANTS

##### "Z" VARIANT

**DSL800 ZU**  
TOOL ONLY + WIRELESS UNIT (DOES NOT INCLUDE BATTERY / CHARGER OR CARRY CASE)

DSL801
18V | **LXT**

### Cordless Drywall Sander

Continuous runtime  
**35min**  
Speed adjusting dial: 3  
Abrasive discs: #120  
Battery: BL1850B

Round brush

- High Dust collection rate achieved with Round brush
- Direct Drive Brushless motor for increased efficiency

- A vacuum hose runs throughout the interior of the tool with a dust port at the base of the tool for use with a dust extractor for dust free sanding
- Overload sensor is designed to alert when excessive load is applied and protect from damage due to overheat
- The adjustable extension pipe for sanding in confined spaces, such as closets, and extends from 1,100mm to 1,520mm" for reaching high walls and ceilings.

Pad diameter	210 mm
Abrasive Disc Size	225 mm
No Load Speed (RPM)	1,000 - 1,800
Sound Pressure Level	75 dB(A)
Vibration Level	2.5 m/s <sup>2</sup> or less
Dimensions (L x W x H)	1,120 - 1,540 x 278 x 273 mm
Net weight	5.8 kg

Standard Equipment: Hex Wrench, Tool bag

#### AVAILABLE VARIANTS

##### "Z" VARIANT

**DSL801 Z**  
TOOL ONLY  
(DOES NOT INCLUDE BATTERY / CHARGER / WIRELESS UNIT OR CARRY CASE)

### Accessories for DSL800 / DSL801

Pad	Type	Part #	Abrasive Disc 225mm		
			Grit	Pcs/Pkg	Part #
Soft	Medium	199940-8	40	25	B-68389
	Hard	199938-5	80	25	B-68395
			120	25	B-68404
			180	25	B-68410
			320	25	B-68426

#### Extension handle set (Optional)

Extension handle allows for an additional 570mm longer reach for sanding high walls and ceilings.  
Part # 199937-7

Waist Belt

Extension handle

Holder

- DRILLING / FIXING
- CONCRETE DRILLING / DEMOLITION
- MIXING / STIRRING
- CUTTING (CONCRETE / METAL)
- GRINDING
- SANDING / POLISHING
- SAWING
- MULTI-TOOL
- ROUTERS / PLANERS
- NAILERS / STAPLERS
- HEAT GUN / LASER
- CLEANING
- OPE
- JBSITE TOOLS
- SPECIALTY TOOLS
- HAND TOOLS / COMBINATION SET
- TOOL HOLDERS AND POUCHES / MAKPAC SYSTEM

DRILLING /  
FIXINGCONCRETE  
DRILLING /  
DEMOLITIONMIXING /  
STIRRINGCUTTING  
(CONCRETE /  
METAL)

GRINDING

SANDING /  
POLISHING

SAWING

MULTI-TOOL

ROUTERS /  
PLANERSNAILERS /  
STAPLERSHEAT GUN /  
LASER

CLEANING

OPE

JOBSITE  
TOOLSSPECIALTY  
TOOLSHAND TOOLS /  
COMBINATION SETTOOL HOLDERS  
AND POUCHES /  
MAKPAC SYSTEM

## Abrasive Belt for Belt Sander

AA, WA: For wood, iron and steel  
CC: For stone and plastics

### For Model: 9032, DBS180

Belt Size (mm)	Grit	Part No.	Pcs per pkg.
6mm x 533mm 	AA40	A-34512	10
	AA60	A-34528	10
	AA80	A-34534	10
	AA100	A-34540	10
	AA120	A-34556	10
9mm x 533mm 	AA40	A-34447	10
	AA60	A-34453	10
	AA80	A-34469	10
	AA100	A-34475	10
	AA120	A-34481	10
13mm x 533mm 	AA40	A-34562	10
	AA60	A-34578	10
	AA80	A-34584	10
	A100	A-34590	10
	AA120	A-34609	10

### For Model: 9030, 9031

Belt Size (mm)	Grit	Part No.	Pcs per pkg.
30mm x 533mm 	AA40	P-36675	5
	AA60	P-36681	5
	AA80	P-36697	5
	AA100	P-36706	5
	AA120	P-36712	5
	AA150	P-36728	5
	AA240	P-36734	5
	CC40	A-23927	5
	CC60	A-23933	5
	CC80	A-23949	5
	CC120	A-23961	5
	CC240	A-23983	5

### For Model: 9901

Belt Size (mm)	Grit	Part No.	Pcs per pkg.
76mm X 533mm 	AA40	794119-2	10
	AA60	794120-7	10
	AA80	794121-5	10
	AA100	794122-3	10
	AA120	794123-1	10
	AA150	794125-7	10

### For Model: 9910 (Belt Sander)

Belt Size (mm)	Grit	Part No.	Pcs per pkg.
76mm x 457mm 	WA40	P-37091	5
	WA60	P-37100	5
	WA80	P-37116	5
	WA100	P-37122	5
	WA120	P-37138	5
	WA150	P-37144	5
WA240	P-37150	5	

### For Model: 9920, 9924DB (Belt Sander)

Belt Size (mm)	Grit	Part No.	Pcs per pkg.
76mm X 610mm 	WA40	P-37312	5
	WA60	P-37328	5
	WA80	P-37334	5
	WA100	P-37340	5
	WA120	P-37356	5
	WA150	P-37362	5
	WA240	P-37378	5

### For Model: 9401, 9403, 9404

Belt Size (mm)	Grit	Part No.	Pcs per pkg.
100mm X 610mm 	WA40	794133-8	5
	WA40	P-36887	5
	WA60	P-36893	5
	WA80	P-36902	5
	WA100	P-36918	5
	WA120	P-36924	5
	WA150	P-36930	5
	WA240	P-36946	5

## Abrasive Paper

Grit: 40-60: Course | 80-120: Medium | 150-240: Fine

For Model: BO4510, BO4553, BO4556, DBO482

Belt Size (mm)	Grit	Part No.	Pcs per pkg.
 114mm X 140mm	60	794195-6	6
	40	P-36398	10
	60	P-32904	10
	80	P-36407	10
	100	P-32910	10
	120	P-32926	10
	150	P-32932	10
	180	P-36413	10
	240	P-36429	10

For Model: 9035, 9036, BO3710, BO3700

Belt Size (mm)	Grit	Part No.	Pcs per pkg.
 93mm X 228mm	100	794157-4	10
	40	P-36136	10
	60	P-32948	10
	80	P-36142	10
	100	P-32954	10
	120	P-36158	10
	150	P-32960	10
	180	P-36164	10
	240	P-36170	10

For Model: BO4900, BO4901, 9046

Belt Size (mm)	Grit	Part No.	Pcs per pkg.
 114 X 280	100	794209-1	10
	40	P-36267	10
	60	P-32976	10
	80	P-36273	10
	100	P-32982	10
	120	P-36289	10
	150	P-32998	10
	180	P-36295	10
	240	P-36304	10

For Model: BO4560

Belt Size (mm)	Grit	Part No.	Pcs per pkg.
 87mm X 160mm	40	794494-6	10
	60	794391-6	10
	80	794495-4	10
	100	794392-4	10
	120	794496-2	10
	150	794393-2	10

## Abrasive Paper (Pre-Punched)

For Model: 9035, 9036, BO3700, BO3710

Belt Size (mm)	Grit	Part No.	Pcs per pkg.
 93mm X 230mm	40	P-31837	10
	60	P-31843	10
	80	P-31859	10
	100	P-31865	10
	120	P-36011	10
	150	P-36027	10
	180	P-36033	10
	240	P-36049	10

For Model: BO4900, BO4901, 9046

Belt Size (mm)	Grit	Part No.	Pcs per pkg.
 115mm X 280mm	40	P-33009	10
	60	P-33015	10
	80	P-33021	10
	100	P-33037	10
	120	P-33043	10
	150	P-33059	10
	180	P-33065	10
	240	P-33071	10

For Model: BO4563, BO4566

(For BO4566 the abrasive paper needs to be cut to 164mm length)

Belt Size (mm)	Grit	Part No.	Pcs per pkg.
 100mm X 240mm	40	P-20644	10
	60	P-20650	10
	80	P-20666	10
	120	P-20688	10
	150	P-20694	10
	180	P-20703	10
	240	P-20719	10
	40	P-42868	10
	60	P-42874	10
	80	P-42880	10
	100	P-42896	10
	120	P-42905	10
	150	P-42911	10
	180	P-42927	10
	240	P-42933	10

## Abrasive Paper (Pre-Punched, Hook & Loop)

For Model: BO4510, BO4553, BO4556, DBO482

Belt Size (mm)	Grit	Part No.	Pcs per pkg.
 114x102	A40	■ D-58665	10
	A60	■ D-58671	10
	A80	■ D-58687	10
	A100	■ D-58693	10
	A120	■ D-58702	10
	A150	■ D-58718	10
	A180	■ D-58724	10
	A240	■ D-58730	10
	A320	■ D-58746	10

DRILLING  
/ FIXING

CONCRETE  
DRILLING /  
DEMOLITION

MIXING /  
STIRRING

CUTTING  
(CONCRETE /  
METAL)

GRINDING

SANDING /  
POLISHING

SAWING

MULTI-TOOL

ROUTERS /  
PLANERS

NAILERS /  
STAPLERS

HEAT GUN /  
LASER

CLEANING

OPE

JOBSITE  
TOOLS

SPECIALTY  
TOOLS

HAND TOOLS /  
COMBINATION SET

TOOL HOLDERS  
AND POUCHES /  
MAKPAC SYSTEM

DRILLING / FIXING

CONCRETE DRILLING / DEMOLITION

MIXING / STIRRING

CUTTING (CONCRETE / METAL)

GRINDING

SANDING / POLISHING

SAWING

MULTI-TOOL

ROUTERS / PLANERS

NAILERS / STAPLERS

HEAT GUN / LASER

CLEANING

OPE

JOBSITE TOOLS

SPECIALTY TOOLS

HAND TOOLS / COMBINATION SET

TOOL HOLDERS AND POUCHES / MAKPAK SYSTEM

### Abrasive Disc - Pre Punched, Hook & Loop

#### Abrasive paper grit

- 40-60: Course
- 80-120: Medium
- 150-240: Fine

For Model: BO3700, BO3710 (Use with pad set 192983-9)  
For Model: DBO380 / DBO381 (Use with pad set 194930-6)

	Grit	Part No.	Pcs per pkg.
 93 x 185mm	40	P-31871	10
	60	P-31887	10
	80	P-31893	10
	100	P-31902	10
	120	P-35891	10
	150	P-35900	10
	180	P-35916	10
	240	P-35922	10

For Model: BO4900, BO4901, 9046  
Use with pad set **193521-0**

	Grit	Part No.	Pcs per pkg.
 15 x 232mm	80	A-14146	5
	100	A-14152	5
	120	A-14168	5
	180	A-14180	5
	240	A-14196	5
	40	P-33174	10
	60	P-33180	10
	80	P-33196	10
	100	P-33205	10
	120	P-33211	10
	150	P-33227	10
	180	P-33233	10
	240	P-33249	10

### Abrasive Disc - Pre-punched (9 hole) for dry wall sander DSL800, DSL801

- Made of high quality, durable rubber for long life.
- Hook and loop design for quick and easy abrasive paper changes.
- 40-60: Course
- 80-120: Medium
- 150-240: Fine

For Model: DSL800, DSL801 (Ceramic grain paper)

Pad Size (mm)	Grit	Part No.	Pcs per pkg.
 255mm with 9 holes	40	B-68389	25
	80	B-68395	25
	120	B-68404	25
	180	B-68410	25
	320	B-68426	25

### Abrasive Disc - Pre Punched, Hook & Loop

For Model: BO5030, BO5041, DBO180

Pad Size (mm)	Grit	Part No.	Pcs per pkg.
 125mm	40	P-43533	10
	60	P-43549	10
	80	P-43555	10
	100	P-43561	10
	120	P-43577	10
	180	P-43583	10
	240	P-43599	10
	320	P-43608	10
	400	P-43614	10

For model: BO6030, BO6050J

Belt Size (mm)	Grit	Part No.	Pcs per pkg.
 150mm	40	P-31918	10
	60	P-31924	10
	80	P-31930	10
	100	P-31946	10
	120	P-31952	10
	150	P-31968	10
	180	P-31974	10
	220	P-31980	10
	240	P-31996	10
	320	P-32007	10
	400	P-32013	10

For wood / for model: BO6030, BO6050J

	Grit	Part No.	Pcs per pkg.
 150mm with 15 holes	40	B-51415	10
	60	B-51421	10
	80	B-51437	10
	100	B-51443	10
	120	B-51459	10
	180	B-51465	10
	240	B-51471	10
	320	B-51487	10
	400	B-51493	10

For stripping the paint / for model: BO6030, BO6050J

	Grit	Part No.	Pcs per pkg.
 150mm with 15 holes	40	B-51502	10
	60	B-51518	10
	80	B-51524	10
	100	B-51530	10
	120	B-51546	10
	180	B-51552	10
	240	B-51568	10
	320	B-51574	10
	400	B-51580	10



## Abrasive Paper 230mm x 280mm for Finishing Sander

How to cut abrasive paper

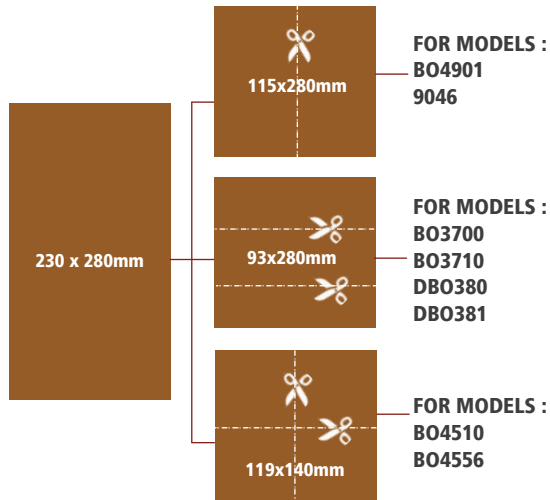

### Stearted Aluminium Oxide Abrasive paper 230x280mm

Application: Coating, (Paint & Varnish)

For Model: All Finishing Sander, Handuse

Belt Size (mm)	Grit	Part No.	Pcs per pkg.
 230mm x 280mm	80	D-60698	100
	100	D-60707	100
	120	D-60713	100
	150	D-60729	100
	180	D-60735	100
	220	D-60741	100
	240	D-60757	100
	280	D-60763	100
	320	D-60779	100
	360	D-60785	100
	400	D-60791	100
	500	D-60800	100
	600	D-60816	100
	800	D-60822	100

### Aluminium Oxide Abrasive paper 230x280mm

Application: For wood

For Model: All Finishing Sander, Handsanding

Belt Size (mm)	Grit	Part No.	Pcs per pkg.
 230mm x 280mm	40	D-52358	50
	60	D-52364	50
	80	D-52370	50
	100	D-52386	50
	120	D-52392	50
	150	D-52401	50
	180	D-52417	50
	240	D-52423	50
	320	D-56895	50
	400	D-56904	50

### Aluminium Oxide Abrasive paper 230x280mm

Application: For metal

For Model: All Finishing Sander, Handsanding

Belt Size (mm)	Grit	Part No.	Pcs per pkg.
 230mm x 280mm	36	D-56764	50
	40	D-56770	50
	60	D-56786	50
	80	D-56792	50
	100	D-56801	50
	120	D-56817	50
	150	D-56823	50
	180	D-56839	50
	240	D-56845	50

### Aluminium Oxide Abrasive paper 230x280mm

Application: For mortar

For Model: All Finishing Sander, Handsanding

Belt Size (mm)	Grit	Part No.	Pcs per pkg.
 230mm x 280mm	60	D-56605	50
	80	D-56611	50
	100	D-56627	50
	120	D-56633	50
	150	D-56649	50
	180	D-56655	50
	240	D-56661	50

### Waterproof Silicon Carbide Abrasive paper 230x280mm

Application: For car body (Glass, Stone, Marbile, Granite)

For Model: All Finishing Sander, Handuse

Belt Size (mm)	Grit	Part No.	Pcs per pkg.
 230mm x 280mm	80	D-58942	50
	100	D-58958	50
	120	D-58964	50
	180	D-58986	50
	220	D-58992	50
	280	D-59003	50
	320	D-59019	50
	400	D-59025	50
	800	D-59047	50
	1000	D-59053	50
	1200	D-56867	50
	1500	D-59069	50
	2000	D-59075	50

DRILLING / FIXING

CONCRETE DRILLING / DEMOLITION

MIXING / STIRRING

CUTTING (CONCRETE / METAL)

GRINDING

SANDING / POLISHING

SAWING

MULTI-TOOL

ROUTERS / PLANERS

NAILERS / STAPLERS

HEAT GUN / LASER

CLEANING

OPE

JOB SITE TOOLS

SPECIALTY TOOLS

HAND TOOLS / COMBINATION SET

TOOL HOLDERS AND POUCHES / MAK-PAC SYSTEM

DRILLING /  
FIXING

CONCRETE  
DRILLING /  
DEMOLITION

MIXING /  
STIRRING

CUTTING  
(CONCRETE /  
METAL)

GRINDING

SANDING /  
POLISHING

SAWING

MULTI-TOOL

ROUTERS /  
PLANERS

NAILERS /  
STAPLERS

HEAT GUN /  
LASER

CLEANING

OPE

JOBSITE  
TOOLS

SPECIALTY  
TOOLS

HAND TOOLS /  
COMBINATION SET

TOOL HOLDERS  
AND POUCHES /  
MAKPAC SYSTEM

## Abrasive Disc 20pcs Set



- Pre Punched
- Hook & Loop

For Model: BO5030, BO5041, DBO180

Pad Size (mm)	Grit	Pcs per pkg.	Part No.
125mm 8 holes	60	5	D-77229
	120	5	
	240	5	
	320	5	

For Model: BO6030, BO6050J

Pad Size (mm)	Grit	Pcs per pkg.	Part No.
150mm (15 holes)	60	5	D-77235
	120	5	
	240	5	
	320	5	

## Abrasive Disc for Disc Sander



For model GV6000, GV6010

CC: For stone and plastics

Diameter (mm)	Grit	Part No.	Pcs per pkg.
150	CC50	794086-1	10
150	CC120	794090-0	10

### Pressure sensitive type

For model GV6000, GV6010

Disc type and use

WA: For wood, iron and steel



Diameter (mm)	Grit	Part No.	Pcs per pkg.
150	WA60	794274-0	10
150	WA100	794275-8	10
150	WA120	794276-6	10
150	WA150	794277-4	10
150	WA180	794278-2	10

## PAD

### Rubber pad for Abrasive Disc

A: For spindle thread 5/8"

B: For spindle thread M14 x 2(DIN), M16 x 2



Outer Diameter (mm)	Type	Part No.
For Model: GV6010 (Pressure sensitive type)		
147	-	743033-9
For Model: 180mm Disc Sander, Polisher, Angle Sander		
170	A	743012-7
For Model: 180mm Disc Sander, Polisher		
170	B	743008-8

## Pad Complete for Abrasive paper



For use with Abrasive paper or clamping type paper

Model	Part No.
BO3700, BO3710, DBO380, DBO381, BO4560	140441-9
	194929-1
BO4560	150067-9
BO4900, BO4901	193523-6
DBO482	191Y25-6

For use with Hook & loop type paper



Model	Part No.
BO3700, BO3710, DBO380 / DBO381	194930-6
BO4900, BO4901	193521-0
DBO482	191Y24-8

For Rectangle / Triangle paper



Model		Part No.
DBO482	Rectangle	191Y23-0
DBO482	Triangle	191Y22-2

## Punch Plate

- Allows for maximum collection of dust and debris from underneath the sander

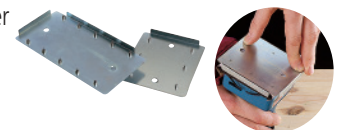

For Model	Part No.
9036	163292-3
BO4901, 9046	192523-3
BO4556, DBO482	450066-4
BO3700	192989-7
DBO380, DBO381	194947-9
DBO482	450066-4

## Sanding Lock Nut

For Model: PV001G, 9207SPB, 9227C



Spindle Thread	Outer Dia (mm)	Part No.
M14 x 2DIN	48	224515-5

## Plastic Pad / Washer & Hex Socket head Bolt

For Model: GV6000, GV6010



Size	Part No.
Plastic pad 120	743025-8
Hex Socket head bolt M8 x 20	265812-0
Washer 10	253951-8

## Rubber pad (used with Pre-punched Abrasive Disc)

HG: Hard (For coarse grinding)  
S: Soft (For general sanding)  
SS: Super Soft (For fine sanding)  
M: Medium (For general sanding)  
H: Hard (For coarse Sanding)



Outer Diameter (mm)	Type	Part No.
---------------------	------	----------

For Model: DSL800, DSL801

150	S	199939-3
150	M	199940-8
150	H	199938-5

For Model: BO6050

150	H	197315-5
150	S	197314-7
150	SS	197316-3

For Model: BO6030, BO6040

150	HG	196685-9
150	S	196684-1
150	SS	196686-7

For Model: BO5030, BO5041, BO5010, BO5020, BO5021, DBO180

125	-	743081-8
-----	---	----------

## Backing Pad for polishers

A : Use with Wool pad, Sleeve or Sponge pad

B : Use with Sanding pad



For Model	Pad size (mm)		Part No.
9227C/CB, 9237C, SA7000C, PV7000C	165		743053-3
			743052-5
PW5001C	100		743080-0
P06000C / DPO600	150		197929-0
DPV300, PV301D	75	for polishing pad	743125-4
DPV300, PV301D	50	for sanding pad	*743124-6

\*743126-2 is the adapter for 743124-6 to connect with sanding pad

## Sponge Pad (Hook & Loop type)

A: Ideal for polishing applications

B: For applying wax, removing wax and polishing

C: For surface treatment

\* Use with Backing pad 743125-4



For Model	Type	Size (mm)	Part No.
9227C/CB, 9237C, SA7000C, PV7000C	A	190 -	193470-1
BO6030, BO6040, BO6050, DPO600, P06000C	B	150 Yellow	197914-3
DPV300, PV301D	B	80 White	* 191N91-7
DPV300, PV301D	C	80 Yellow	* 191N90-9

## Wool Pad (Hook & Loop type)

• For high gloss polishing

A: Use with Backing pad 743125-4

B: Use with Backing pad and Sleeve 18 (262542-4)



For Model	Size (mm)	Type	Part No.
DPV300, PV301D	80	A	191N92-5
-	100		794173-6
BO5021, BO5041	140		794560-9
BO6030, BO6040, BO6050, P06000C / DPO600	150		199424-6
9207SPB, 9218PB, SA7000C, PV7000C, PV001G	180	B	*192629-7
9237CB, SA7000C, PV7000C, PV001G	180		P-45135 (thread type)

DRILLING / FIXING

CONCRETE DRILLING / DEMOLITION

MIXING / STIRRING

CUTTING (CONCRETE / METAL)

GRINDING

SANDING / POLISHING

SAWING

MULTI-TOOL

ROUTERS / PLANERS

NAILERS / STAPLERS

HEAT GUN / LASER

CLEANING

OPE

JOB SITE TOOLS

SPECIALTY TOOLS

HAND TOOLS / COMBINATION SET

TOOL HOLDERS AND POUCHES / MAKPAC SYSTEM

DRILLING /  
FIXING

CONCRETE  
DRILLING /  
DEMOLITION

MIXING /  
STIRRING

CUTTING  
(CONCRETE /  
METAL)

GRINDING

SANDING /  
POLISHING

SAWING

MULTI-TOOL

ROUTERS /  
PLANERS

NAILERS /  
STAPLERS

HEAT GUN /  
LASER

CLEANING

OPE

JOBSITE  
TOOLS

SPECIALTY  
TOOLS

HAND TOOLS /  
COMBINATION SET

TOOL HOLDERS  
AND POUCHES /  
MAKPAC SYSTEM

### Felt Pad (Hook & Loop type)

- For removing wax



For Model	Size (mm)	Part No.
BO6030, BO6040, BO6050, DPO600, PO6000C	150	794618-4

### Fiber sanding disc

- Used with DVP300, PV301D polishers for sanding work

Diameter: 50mm, Twist-on/twist-off type, 25pcs/set  
For Material: Metal / Stainless, Aluminium  
(Pad 743124-6 is required to use the disc)



For Model	Size (mm)	Part No.
A60	Grinding, Chamfer, Deburring, Surface polishing	E-07412
A80		E-07428
A120		E-07434
Z60	Grinding, Chamfer, Deburring	E-07440
Z80		E-07456

### Surface conditioning disc

- Used with DVP300, PV301D polishers for sanding work

Diameter: 50mm, Twist-on/twist-off type, 25pcs/set  
For Material: Metal / Stainless, Aluminium  
(Pad 743124-6 is required to use the disc)



For Model	Size (mm)		Part No.
Hard	Surface polishing, Removing paint /rust	Coarse	E-07462
		Medium	E-07478
		Fine	E-07484
Soft	Surface polishing	Medium	E-07490
		Fine	E-07509
		Very fine	E-07515

### Cotton Buff Wheel 120

- For polishing

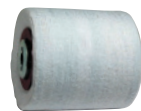

For Model	Part No.
9741	794381-9

### Wire brush Wheel 120

- For rust removal



For Model	Part No.
9741	794382-7

### Slit Paper Wheel 120-140

- For rust & paint removal



For Model	Part No.
9741	794380-1

### Nylon Brush Wheel 120

- To enhance wood grain

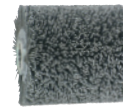

For Model	Use	Part No.
9741	120-80 Coarse	794384-3
	120-100 Medium	794379-6
	120-240 Fine	794383-5

### Ruber pad assembly

- Application: Buffing
- Features: Mounts buffing pad to drill
- Allows drill to be used for buffing



Collet Size	Size	Part No.
6mm	98mm	123001-2

### Foam polishing pad

- Application: Polishing, glass, metal, paint
- Used on cordless drills with shank for chuck.
- Foam polishing pad 125mm dia for applying wax and polishing compounds



Size	Part No.
125mm dia.	794159-0

## Diamond Polishing Pad (100mm)

- For Model: PW5000C, PW5001C (Hook & loop type)



Color	Grit	Max. RPM	Part No.
Blue	50	4,500	D-15584
Yellow	100	4,500	D-15590
Orange	200	4,500	D-15609
Red	400	4,500	D-15615
Dark Green	800	4,500	D-15621
Light Green	1500	4,500	D-15637
Brown	3000	4,500	D-15643
Green	Buff (Finishing)	4,500	D-15659
1 pc. of each polishing pad - 8 pcs set.		4,500	D-15805

## Sanding Shoe Assembly

- Allows use of Belt Sander's linear motion and speed control for fine finishing.



For Model	Part No.
9404	193072-3

## Clamp Complete

- Provides a secure holding for the sander and a steady work-base for the operator



For Model	Part No.
9910	192694-6

## Step

- Mounts sander upside down for easier finishing of smaller pieces



For Model	Part No.
9401	342332-2

## Sanding Arm Assembly

Type A: Standard equipment for 9032



For Model	Size (mm)	Size (mm)	Part No.
9032, DBS180	6	-	125157-7
	9	A	125158-5
	13	-	125159-3

## Carbon Plate

- Used with Abrasive Belt WA/AA type and Cork Rubber Plate.



For Model	Part No.
9401	423029-3
9403	421648-9
9404	423317-8
9920	423316-0
9920	193198-1

## Cork Rubber Plate

- Used with Abrasive Belt WA/AA type and Carbon Plate



For Model	Part No.
9401, 9403	421093-8
9404	423314-4
9920	423313-6

## Steel Plate

- Used with: Abrasive Belt CC type  
Type A: Includes Cork Rubber Plate.



For Model	Type	Part No.
9401	-	342328-3
9403	A	150980-1
9404	A	151751-9
9900B	-	342466-1
9924DB	-	341705-6

## Stand Set

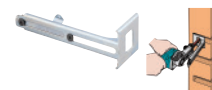

For Model	Part No.
9032, DBS180	193618-5

## Belt Sander Stand

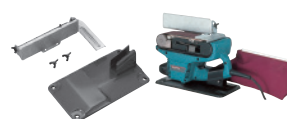

For Model	Part No.
9404, 9902, 9903, 9920	193055-3
9900B, 9924DB	STEX122299

DRILLING  
/ FIXINGCONCRETE  
DRILLING /  
DEMOLITIONMIXING /  
STIRRINGCUTTING  
(CONCRETE /  
METAL)

GRINDING

SANDING /  
POLISHING

SAWING

MULTI-TOOL

ROUTERS /  
PLANERSNAILERS /  
STAPLERSHEAT GUN /  
LASER

CLEANING

OPE

JOBSITE  
TOOLSSPECIALTY  
TOOLSHAND TOOLS /  
COMBINATION SETTOOL HOLDERS  
AND POUCHES /  
MAKPAC SYSTEM

- DRILLING / FIXING
- CONCRETE DRILLING / DEMOLITION
- MIXING / STIRRING
- CUTTING (CONCRETE / METAL)
- GRINDING
- SANDING / POLISHING
- SAWING
- MULTI-TOOL
- ROUTERS / PLANERS
- NAILERS / STAPLERS
- HEAT GUN / LASER
- CLEANING
- OPE
- JOBSITE TOOLS
- SPECIALTY TOOLS
- HAND TOOLS / COMBINATION SET
- TOOL HOLDERS AND POUCHES / MAKPAC SYSTEM

### Dust bag assembly

For All Finishing Sanders and Orbit Sanders (except for BO6050J)

	Part No.	
	152456-4	
	151780-2	
	140115-2	
	135222-4	
 (Plastic)	135327-0	Used with Nonwoven fabric dust bag  195134-3 (5pcs set) Sold separately
 (Plastic)	135246-0	Used with Paper dust bag  194746-9 (5pcs set) Sold separately
	166047-5	Used with  416063-0 Nozzles Sold separately
	166078-4	Used with  416064-8 + 
Nozzles are must to connect dust bag with the tools		
	151517-7	Used with  151518-5 Nozzle is must to connect dust bag with the tools
	193294-5	Used with  Paper dust bag Sold separately 193526-0 or 193293-7 (5pcs set) 

### Dust bag assembly

For Belt Sanders 

For Model	Part No.
9032	122297-2
9924DB	122296-4
9903, 9404, 9920	122591-2
9403	122562-9
9910	122548-3

### Grip/Loop Handle

  
Grip

  
Loop Handle

For Model	Type	Part No.
<b>Disc Sander</b>		
GV6000, GV6010, GV7000C	Grip	152491-2
<b>Polisher and Sander-Polisher</b>		
9218PB, 927SPB	Grip	152492-0
<b>Polisher</b>		
PV7000C	Grip	273649-1
PV001G	Grip	158237-4
PV001G	Loop Handle	413F67-9
<b>Sander-polisher</b>		
9227C	Grip	153489-2
9227C	Loop Handle	416256-9
9227CB	Loop Handle	416348-4
<b>Angle Sander</b>		
SA7000C, SA7021	Grip	152539-0

### Lock Nut Wrench



For Model	Size	Part No.
9218SB/9218PB/GV7000C	28	782423-1
SA7000C/SA7021	35	782407-9
9207SPB	28	782412-6

### Hex Wrench



For Model	Size	Part No.
BO6040/BO6030/GV6010	5	783203-8
9227C/9741	6	783204-6

# Sawing

Slide Compound Miter Saw, Circular Saw, Table Saw  
Jig Saw, Reciprocating Saw, Scroll Saw, Band Saw



DRILLING /  
FIXING

CONCRETE  
DRILLING /  
DEMOLITION

MIXING /  
STIRRING

CUTTING  
(CONCRETE /  
METAL)

GRINDING

SANDING /  
POLISHING

SAWING

MULTI-TOOL

ROUTERS /  
PLANERS

NAILERS /  
STAPLERS

HEAT GUN /  
LASER

CLEANING

OPE

JOBSITE  
TOOLS

SPECIALTY  
TOOLS

HAND TOOLS /  
COMBINATION SET

TOOL HOLDERS  
AND POUCHES /  
MAKPAC SYSTEM

# DXT

## Deep and Exact Cutting Technology

Diameter of slide pipe is changed from 25mm to 30mm. Moreover, by redesigning arm section shape, the precision at bevel cutting is increased

Integration of Guide fence and Lower fences provides the rigidity more than the separation structure.

### Our Range of Slide Compound Miter Saw / Miter Saw

	355mm	305mm	260mm	255mm	216mm	190mm	165mm
XGT		● LS003G 40V MAX	● LS004G 40V MAX		● LS002G 40V MAX		
LXT		● DSL211 18VX2 LXT	● DSL111 18VX2 LXT			● DLS714 18VX2 LXT ● DLS713 18V LXT	● DLS600 18V LXT
AC	● LH1201FL 1,650W	● LS1219L 1,800W	● LS1019L 1,510W	● LS1018LN 1,430W	● LS0815FL 1,400W	● LS7014 1,010W	
	● LS1440 1,380W		● LH1040 1,650W	● LS1040 1650W			
				● MLS100N 1,500W			
	● Slide Compound Miter Saw		● Compound Miter Saw		● Table Top Miter Saw		● Miter Saw



**LS003G** 305mm **40V MAX | XGT**

**Cordless Slide Compound Miter Saw**



**Equipped with a brushless motor that provides consistently smooth cutting**

- Rail-forward design: allows the rear of the machine to be placed close to the wall
- One-touch sliding lock
- Large turn base
- Positive stop function can be disabled simply by depressing a lever
- Easy locking and release of bevel angle
- Switch to start up dust extractor (via bluetooth technology)
- LED lamp casts a shadow of the saw blade onto the workpiece as an exact cutting line.

**40Vmax MOTOR AWS DXT**

<b>Blade Diameter</b>	305 mm
<b>Hole Diameter</b>	25.4, 30 mm
<b>Miter Angle</b>	60° L 60° R
<b>Bevel Angle</b>	48° L 48° R
<b>Max Cutting Capacity</b>	0° Miter: 107 x 363 mm / 45° Miter, L/R: 107 x 255 mm
<b>No Load Speed (RPM)</b>	3,600
<b>Dimensions (L x W x H)</b>	898 x 690 x 725 mm
<b>Net weight</b>	28.9 kg (WITHOUT BATTERY)

**Standard Equipment:** Dust Bag, Triangular Rule, Vertical Vise, Hex Wrench

AVAILABLE VARIANTS

**"Z" VARIANT**

**LS003G Z**  
TOOL ONLY  
(DOES NOT INCLUDE BATTERY / CHARGER / CARRYING CASE)

**LS002G** 216mm **40V MAX | XGT**

**Cordless Slide Compound Miter Saw**



**Equipped with a brushless motor that provides consistently smooth cutting**

- Rail-forward design: allows the rear of the machine to be placed close to the wall
- One-touch sliding lock , Large turn base
- Positive stop function can be disabled simply by depressing a lever
- Easy locking and release of bevel angle
- Switch to start up dust extractor (via bluetooth technology)
- LED lamp casts a shadow of the saw blade onto the workpiece

**40Vmax MOTOR AWS DXT**

<b>Blade Diameter</b>	216 mm
<b>Hole Diameter</b>	25.4, 30 mm
<b>Miter Angle</b>	60 / 60° L 60, 60° R
<b>Bevel Angle</b>	48 / 48° L 48, 48° R
<b>Max Cutting Capacity</b>	0° Miter: 70 x 312 mm / 45° Miter, L/R: 70 x 220 mm
<b>No Load Speed (RPM)</b>	4,800
<b>Dimensions (L x W x H)</b>	702 x 551 x 557 mm
<b>Net weight</b>	15.2 kg (without battery)

**Standard Equipment:** Dust Bag, Triangular Rule, Vertical Vise, Hex Wrench

AVAILABLE VARIANTS

**"Z" VARIANT**

**LS002G Z**  
TOOL ONLY  
(DOES NOT INCLUDE BATTERY / CHARGER / CARRYING CASE)

**LS004G** 260mm **40V MAX | XGT**

**Cordless Slide Compound Miter Saw**



**Equipped with a brushless motor that provides consistently smooth cutting**

- Rail-forward design: allows the rear of the machine to be placed close to the wall
- One-touch sliding lock
- Large turn base
- Positive stop function can be disabled simply by depressing a lever
- Easy locking and release of bevel angle
- Switch to start up dust extractor (via bluetooth technology)
- LED lamp casts a shadow of the saw blade onto the workpiece as an exact cutting line.

**40Vmax MOTOR AWS DXT**

<b>Blade Diameter</b>	260 mm
<b>Hole Diameter</b>	25.4, 30 mm
<b>Miter Angle</b>	60° L 60° R
<b>Bevel Angle</b>	48° L 48° R
<b>Max Cutting Capacity</b>	0° Miter: 91 x 279 mm / 45° Miter, L/R: 91 x 197 mm
<b>No Load Speed (RPM)</b>	3,600
<b>Dimensions (L x W x H)</b>	805 x 644 x 660 mm
<b>Net weight</b>	25.1 kg (WITHOUT BATTERY)

**Standard Equipment:** Dust Bag, Triangular Rule, Vertical Vise, Hex Wrench

AVAILABLE VARIANTS

**"Z" VARIANT**

**LS004G Z**  
TOOL ONLY  
(DOES NOT INCLUDE BATTERY / CHARGER / CARRYING CASE)

**DLS211** 305 mm **18Vx2 LXT**

**Cordless Slide Compound Miter Saw**



**Powerful / Efficient**

- Combination of Brushless motor, Twin battery system and Miter saw innovation makes the machine more powerful and efficient as similar as corded slide compound miter saw.

**36V ULTRALIGHT MOTOR ADT DXT AWS**

<b>Blade Diameter</b>	305 mm (12")
<b>Miter Angle</b>	60° L / 60° R
<b>Bevel Angle</b>	48° L / 48° R
<b>Max Cutting Capacity</b>	90° Miter: 107 x 363 mm 90° Miter: 92 x 382 mm 45° Miter, L/R: 107 x 255 mm 45° Miter, L/R: 92 x 268 mm
<b>No Load Speed (RPM)</b>	4,400
<b>Vibration Level</b>	2.5 m/s <sup>2</sup> or less
<b>Dimensions (L x W x H)</b>	898x690x725 mm
<b>Net weight</b>	28.9 kg

**Standard Equipment:** Triangular Rule, Vertical Vise, Hex Wrench

AVAILABLE VARIANTS

**"Z" VARIANT**

**DLS211 ZU**  
TOOL ONLY (WITH BLUETOOTH CHIP)  
(DOES NOT INCLUDE BATTERY / CHARGER)

- DRILLING / FIXING
- CONCRETE DRILLING / DEMOLITION
- MIXING / STIRRING
- CUTTING (CONCRETE / METAL)
- GRINDING
- SANDING / POLISHING
- SAWING
- MULTI-TOOL
- ROUTERS / PLANERS
- NAILERS / STAPLERS
- HEAT GUN / LASER
- CLEANING
- OPE
- JOB SITE TOOLS
- SPECIALTY TOOLS
- HAND TOOLS / COMBINATION SET
- TOOL HOLDERS AND POUCHES / MAKPAC SYSTEM

DRILLING /  
FIXINGCONCRETE  
DRILLING /  
DEMOLITIONMIXING /  
STIRRINGCUTTING  
(CONCRETE /  
METAL)

GRINDING

SANDING /  
POLISHING

SAWING

MULTI-TOOL

ROUTERS /  
PLANERSNAILERS /  
STAPLERSHEAT GUN /  
LASER

CLEANING

OPE

JOBSITE  
TOOLSSPECIALTY  
TOOLSHAND TOOLS /  
COMBINATION SETTOOL HOLDERS  
AND POUCHES /  
MAKPAC SYSTEM

DLS111 260 mm

18Vx2 LXT

## Cordless Slide Compound Miter Saw



## Powerful / Efficient

- Combination of Brushless motor, Twin battery system and Miter saw innovation makes the machine more powerful and efficient as similar as corded slide compound miter saw.



Blade Diameter	260 mm
Miter Angle	60° L / 60° R
Bevel Angle	48° L / 48° R
Max Cutting Capacity	90° Miter: 91 x 279 mm 90° Miter: 68 x 310 mm 45° Miter, L/R: 91 x 197 mm 45° Miter, L/R: 68 x 218 mm
No Load Speed (RPM)	4,400
Vibration Level	2.5 m/s <sup>2</sup> or less
Dimensions (L x W x H)	805x644x660 mm
Net weight	27.3 kg

**Standard Equipment:** Triangular Rule, Vertical Vise, Hex Wrench

## AVAILABLE VARIANTS

## "Z" VARIANT

**DLS111 ZU**  
TOOL ONLY (WITH BLUETOOTH CHIP) (DOES NOT INCLUDE BATTERY / CHARGER)

DLS714 190mm

18Vx2 LXT

## Cordless Slide Compound Miter Saw



## High power delivered by Brushless motor, enables to cut as fast as AC slide compound miter saw.

- Automatic speed control; automatically changes the cutting speed according to load conditions for an optimum operation.
- Double sliding mechanism; Makita advantages obtained by using 4 short steel poles with 4 linear ball bearings
- Bevel angle: 45 degrees left to 5 degrees right



Max output	1,200W
Max cutting capacity	at 0 degrees: 52x300mm / at 45 degrees left: 40x300mm at 5 degrees right: 40x300mm
Blade diameter	190mm
No load speed (rpm)	5,700
Dimensions (L x W x H)	655x430x445mm
Net weight	12.6kg

**Standard Equipment:** Hex wrench

## "Z" VARIANT

**DLS714 Z**  
TOOL ONLY (WITH CARRY CASE) (DOES NOT INCLUDE BATTERY / CHARGER)

DLS713 190mm

18V | LXT

## Cordless Slide Compound Miter Saw



## High Power but Compact

- Double sliding mechanism.
- Soft elastomer carrying grip provides easy job site portability.



Max cutting capacity	at 0 degrees: 52 x 300mm at 45 degrees: 25x 300mm
Blade diameter	190mm
Bore	20mm
No load speed (rpm)	2,200
Dimensions (L x W x H)	655 x 430 x 454mm
Net weight	12.7kg

**Standard Equipment:** Vertical Vise, Socket Wrench, Triangular Rule, Dust Bag, Holder set.

## AVAILABLE VARIANTS

## "Z" VARIANT

**DLS713 Z**  
TOOL ONLY  
(DOES NOT INCLUDE BATTERY / CHARGER OR CARRY CASE)

DLS600 165 mm

18V | LXT

## Cordless Compound Miter Saw



## High accuracy + Lightweight + Cordless

- Suitable for Cutting Baseboard and Ceiling Trim, etc.
- Compact and lightweight body provides excellent portability



Blade Diameter	165 mm
Miter Angle	52° L / 52° R
Bevel Angle	46° L / 46° R
Max Cutting Capacity	90° Miter: 46 x 92 mm
No Load Speed (RPM)	5,000
Dimensions (L x W x H)	340x400x440 mm
Net weight	6.6 kg

**Standard Equipment:** Vertical Vise, Hex Wrench, Triangular Rule

## AVAILABLE VARIANTS

## "Z" VARIANT

**DLS600 Z**  
TOOL ONLY  
(DOES NOT INCLUDE BATTERY / CHARGER OR CARRY CASE)

**LS1219L 305mm** 

**Slide Compound Miter Saw**



**Single sliding system enables smooth operation to produce superior cuts**

- Large turn base supports workpiece securely for increased stability
- Integrated guide fences for increased rigidity and high cutting accuracy
- Increased dust extraction rate for a cleaner work environment
- Rail-forward design enables to be placed against a wall for maximizing work space
- Independent laser switch Laser marker



<b>Continuous rating input</b>	1,800W
<b>Blade Diameter</b>	305 mm
<b>Bevel Angle</b>	60° L / 60° R
<b>Miter Angle</b>	48° L / 48° R
<b>Max Cutting Capacity</b>	90°: 107 x 363 mm
<b>(Bevel/Miter)</b>	45°: 107 x 255 mm
<b>No Load Speed (RPM)</b>	3,200
<b>Dimensions (L x W x H)</b>	898x644x725 mm
<b>Net weight</b>	29.3 kg
<b>Power supply cord</b>	2.5 m

**Standard Equipment:** Dust Bag, Triangular Rule, Vertical Vise, Hex Wrench

**LS1019L 260 mm** 

**Slide Compound Miter Saw**



**Single sliding system enables smooth operation to produce superior cuts**

- Large turn base supports workpiece securely for increased stability
- Integrated guide fences for increased rigidity and high cutting accuracy
- Increased dust extraction rate for a cleaner work environment
- Rail-forward design enables to be placed against a wall for maximizing work space
- Independent laser switch Laser marker



<b>Continuous rating input</b>	1,510W
<b>Blade Diameter</b>	260 mm
<b>Bevel Angle</b>	48° L / 48° R
<b>Miter Angle</b>	60° L / 60° R
<b>Max Cutting Capacity (Bevel/Miter)</b>	90°/45°LR: 68 / 218 mm
	90°/45°LR: 91 / 197 mm
<b>No Load Speed (RPM)</b>	3,200
<b>Dimensions (L x W x H)</b>	805x644x660 mm
<b>Net weight</b>	26.3 kg
<b>Power supply cord</b>	2.5 m

**Standard Equipment:** Dust Bag, Triangular Rule, Vertical Vise, Hex Wrench

**LS1018LN 255mm** 

**Slide Compound Miter Saw**



**Bevel cutting 45 degrees left and right**

- Ergonomically designed rubberized soft grip provides more control and comfort
- Laser marker for easy cut line alignment



<b>Continuous rating Input</b>	1,430W
<b>Max cutting capacity</b>	at 0 degrees : 91 x 305mm
	at 45 degrees : 91 x 215mm
<b>Blade diameter</b>	255 - 260mm
<b>Blade bore</b>	15.88 / 30mm (Ring 16)
<b>No load speed (rpm)</b>	4,300
<b>Dimensions (L x W x H)</b>	536 x 825 x 633mm
<b>Net weight</b>	19.9kg
<b>Power supply cord</b>	2.5m

**Standard Equipment:** Vertical Vise, Socket Wrench, Triangular Rule, Dust Bag, Holder Assembly

**LS0815FL 216mm** 

**Slide Compound Miter Saw**



**High dust extraction for clean work environment**

- Max cutting depth of 65mm at 90° and 50mm at 45° bevel left.
- Laser marker for easy cut line alignment.
- Easy bevel angle change from 45° to 48° left and from 0° (right angle) to 5° right with simple operation of a push-button.
- Miter range of 50° left and 60° right with positive stops at 0°, 15°, 22.5°, 31.6°, 45° left/right, 50° left and 60° right



<b>Continuous rating input</b>	1,400W
<b>Max cutting capacity</b>	at 0 degrees : 65x305mm
	at 45 degrees : 50x305mm
<b>Blade diameter</b>	216mm
<b>No load speed (rpm)</b>	5,000
<b>Dimensions (L x W x H)</b>	755x450x488mm
<b>Net weight</b>	14.1kg
<b>Power supply cord</b>	2.5m

**Standard Equipment:** Socket wrench, Dust bag, Holder set, Vertical vise, Triangular rule

- DRILLING / FIXING
- CONCRETE DRILLING / DEMOLITION
- MIXING / STIRRING
- CUTTING (CONCRETE / METAL)
- GRINDING
- SANDING / POLISHING
- SAWING
- MULTI-TOOL
- ROUTERS / PLANERS
- NAILERS / STAPLERS
- HEAT GUN / LASER
- CLEANING
- OPE
- JOB SITE TOOLS
- SPECIALTY TOOLS
- HAND TOOLS / COMBINATION SET
- TOOL HOLDERS AND POUCHES / MAKPAC SYSTEM

- DRILLING / FIXING
- CONCRETE DRILLING / DEMOLITION
- MIXING / STIRRING
- CUTTING (CONCRETE / METAL)
- GRINDING
- SANDING / POLISHING
- SAWING

LS0714 190mm AG

**Slide Compound Miter Saw**



**Double sliding mechanism makes it lighter and more compact, requiring smaller work space, allowing quick storing and easy transport**

- Max cutting capacity 300mm (width) (11-3/4").
- All the four rails ride on a linear ball bearings which creates dual sliding of saw head



<b>Continuous rating Input</b>	1,010W
<b>Max cutting capacity</b>	at 0 degrees : 52mm x 300mm (2-1/16" x 11-3/4") at 45 degrees : 52mm x 212mm (2-1/16" x 8-3/8")
<b>Blade diameter</b>	190mm (7-1/2")
<b>Blade bore</b>	20mm
<b>No load speed</b>	6,000rpm
<b>Dimensions (L x W x H)</b>	670mm x 430mm x 458mm (26-3/8" x 17" x 18")
<b>Net weight</b>	13.1kg (28.9lbs)
<b>Power supply cord</b>	2.5m (8.2ft)

**Standard Equipment:** Socket Wrench, Dust Bag, Holder Set, Vertical Vise, Triangular Rule

- MULTI-TOOL
- ROUTERS / PLANERS

LS1040 255mm AG

**Compound Miter Saw**



**Robust construction for consistently accurate cuts**

- Bevel cuts to 45 degrees left
- Pivoting fence provide efficient support to stock



<b>Continuous rating Input</b>	1,650W
<b>Max cutting capacity</b>	at 0 degrees : 90.5 x 95mm (3-9/16" x 3-3/4") at 45 degrees : 90.5 x 67mm (3-9/16" x 2-5/8")
<b>Blade diameter</b>	255 - 260mm (10" - 10-1/4")
<b>Blade bore</b>	15.88 / 30mm (Ring 16)
<b>No load speed</b>	4,600rpm
<b>Dimensions (L x W x H)</b>	530 x 532 x 476mm (20-7/8" x 21" x 18-3/4")
<b>Net weight</b>	12.4kg (27.3lbs)
<b>Power supply cord</b>	2.5m (8.2ft)

**Standard Equipment:** Socket Wrench, Dust Bag, Holders 2, Vertical Vise, Triangular Rule

- NAILERS / STAPLERS
- HEAT GUN / LASER
- CLEANING
- OPE
- JOBSITE TOOLS
- SPECIALTY TOOLS
- HAND TOOLS / COMBINATION SET
- TOOL HOLDERS AND POUCHES / MAKPAC SYSTEM

LS1440 355mm AG

**Miter Saw**



**Clean miter cutting up to 45 degrees, right or left**

- Self-aligning center plates on the guide fence for less splintering
- Large cutting capacity with 355mm (14") blade



<b>Continuous rating Input</b>	1,380W
<b>Max cutting capacity</b>	at 0 degrees : 122 x 152mm (4-13/16" x 6") at 45 degrees : 122 x 115mm (4-13/16" x 4-1/2")
<b>Blade diameter</b>	355mm (14")
<b>Blade bore</b>	25mm
<b>No load speed</b>	3,200rpm
<b>Dimensions (L x W x H)</b>	596 x 530 x 435mm (23-1/2" x 20-7/8" x 17-1/8")
<b>Net weight</b>	34.2kg (75.4lbs)
<b>Power supply cord</b>	2.5m (8.2ft)

**Standard Equipment:** Socket Wrench, Vise Assembly, Dust Bag, Holder Set

MLS100N 255mm AG

**Miter Saw**



**Compact and robust construction for more accurate cuts**

- Same performance, precision and durability as LS1040
- Bevel cuts to 45 degrees left



<b>Continuous rating Input</b>	1,500W
<b>Max cutting capacity</b>	at 0 degrees : 75 x 90mm at 45 degrees : 48 x 90mm
<b>Blade diameter</b>	255 mm
<b>No load speed</b>	4,200rpm
<b>Dimensions (L x W x H)</b>	610 x 485 x 515mm
<b>Net weight</b>	14.7kg
<b>Power supply cord</b>	2.5m (8.2ft)

**Standard Equipment:** Socket Wrench, Dust Bag, Holders 2, Vertical Vise, Triangular Rule

### LH1201FL 305mm

**Table Top Miter Saw**



**Max. cutting width up to 200mm**

- Able to cut two layers of 192mm x thickness 23mm wood floorings in a single stroke
- Sturdy cast aluminum table
- Laser marker allows for easy ink line alignment
- 4 LED job lights provides a clear view of ink line even in dark places when the tool is used as a miter saw



<b>Continuous rating Input</b>	1,650W
<b>Max cutting capacity</b>	at 0 degrees : 95 x 155mm (3-3/4" x 6-1/8") at 45 degrees : 64 x 155mm (2-1/2" x 6-1/8")
<b>Blade diameter</b>	305mm (12")
<b>No load speed (rpm)</b>	3,800
<b>Dimensions (L x W x H)</b>	610 x 535 x 692mm (24" x 21" x 27-1/4")
<b>Net Weight</b>	20.7kg (45.6lbs)
<b>Power supply cord</b>	2.5m (8.2ft)

**Standard Equipment:** Vertical vise, Dust bag, Guide rule, Ring, Triangular rule, Push stick, Blade cover, Socket wrench, Holder set

### LH1040 260mm

**Table Top Miter Saw**



**Miter saw and table saw packed in one tool for great versatility**

- Weighs only 14.3kg for easy transport to job sites.
- With sturdy cast aluminum table.
- Anti-restart switch protects user from accidental start.
- Powerful 1,650W motor allows easy rip cutting



<b>Continuous rating Input</b>	1,650W
<b>Max cutting capacity</b>	at 0 degrees : 93 x 95mm (3-5/8" x 3-3/4") at 45 degrees : 53 x 95mm (2-1/6" x 3-3/4")
<b>Table saw mode</b>	40mm
<b>Blade diameter</b>	260mm (10-1/4")
<b>Blade bore</b>	15.88 / 30mm (Ring 16)
<b>No load speed</b>	4,800rpm
<b>Dimensions (L x W x H)</b>	530 x 476 x 535mm (20-7/8" x 18-3/4" x 21")
<b>Net weight</b>	14.3kg (31.5lbs)
<b>Power supply cord</b>	2.5m (8.2ft)

**Standard Equipment:** Rip Fence, Set Plate, Holder, Blade Cover, Push Stick, Socket Wrench, Triangular Rule, Sub Plate Assembly, Dust Bag

### LF1000 260mm

**Flip Over Saw**



**Light weight motor enables quick conversion of table and mittersaw**

- Tough motor ideal for cutting material with load, bevel cut (max. 45 degrees left), cutting thick material.
- Compact fold away legs allow easy transport to job site.
- Rigid cast aluminium table.



<b>Continuous rating Input</b>	1,650W
<b>Max cutting capacity</b>	at 0 degrees : 20mm x 210mm (13/16" x 8-1/4") at 45 degrees : 50mm x 150mm (2" x 5-7/8")
<b>Table saw mode</b>	70mm
<b>Blade diameter</b>	260mm (10-1/4")
<b>Blade bore</b>	15.88 / 30mm (Ring 16)
<b>No load speed</b>	2,700rpm
<b>Dimensions (L x W x H)</b>	Miter saw : 660 x 650 x 800 (1,220)mm (26" x 25-1/2" x 31 (48") Table saw : 660 x 650 x 845 (1,060)mm (26" x 25-1/2" x 33-1/4 (41-3/4"))
<b>Net weight</b>	36.0kg (79.4lbs)
<b>Power supply cord</b>	2.5m (8.2ft)

**Standard Equipment:** Rip Fence, Bevel Guide, Push Stick, Blade Guard, Dust Cover, Dust Bag, Wrench 8

### 2712 315mm

**Table Saw**



**315mm table saw with induction motor**

- Left extension sub-table is provided.
- The table saw installs the connection for vacuum.
- The table saw has two wheel for transportation



<b>Continuous rating Input</b>	220V: 2,000W / 127V: 1,760W
<b>Max cutting capacity</b>	at 0 degrees : 85mm (3-3/8") at 45 degrees : 58mm (2-1/4")
<b>Blade diameter</b>	315mm (12-3/8")
<b>No load speed (rpm)</b>	50Hz: 2,950 60Hz: 3,400
<b>Bevel cutting capacity (degrees)</b>	0 - 45
<b>Dimensions (L x W x H)</b>	1,670 x 700 x 810mm (65-3/4" x 27-1/2" x 32")
<b>Net weight</b>	52.9kg (116.6lbs)
<b>Power supply cord</b>	3.0m (9.8ft)

**Standard Equipment:** Rip fence, Miter gauge, Wrenches, Push stick, Extension Table

- DRILLING / FIXING
- CONCRETE DRILLING / DEMOLITION
- MIXING / STIRRING
- CUTTING (CONCRETE / METAL)
- GRINDING
- SANDING / POLISHING
- SAWING
- MULTI-TOOL
- ROUTERS / PLANERS
- NAILERS / STAPLERS
- HEAT GUN / LASER
- CLEANING
- OPE
- JOBSITE TOOLS
- SPECIALTY TOOLS
- HAND TOOLS / COMBINATION SET
- TOOL HOLDERS AND POUCHES / MAKPAC SYSTEM

DRILLING / FIXING
CONCRETE DRILLING / DEMOLITION
MIXING / STIRRING
CUTTING (CONCRETE / METAL)
GRINDING
SANDING / POLISHING
<b>SAWING</b>
MULTI-TOOL

**MLT100N 260mm** 

**Table Saw**



**Sliding left extension sub-table is provided**

- Right and rear extension table enables greater cutting capacity.
- Safety guard is installable and removable without tool.
- On-tool storage for accessories is provided.

 **JM230001** 



<b>Continuous rating Input</b>	1,500W
<b>Capacity</b>	at 0 degrees : 91mm (3-9/16") at 45 degrees : 63mm (2-1/2")
<b>Blade diameter</b>	260mm
<b>No load speed (rpm)</b>	4,300
<b>Dimensions (L x W x H)</b>	726 x 984 x 333mm (28-1/2"x38-3/4"x13-1/8")
<b>Net weight</b>	34.1kg (75.2lbs)
<b>Power supply cord</b>	2.5m (8.2ft)

**Standard Equipment:** Rip Fence, Miter Gauge, Wrenches, Push Stick, Triangular Rule

ROUTERS / PLANERS
-------------------

**2704N 255mm (10")** 

**Table Saw**

**Rigid, precision cutting, high spec table saw**

- Machined saw table with high rigidity delivers accurate cutting work.
- Powerful motor enables ripping 4" x 8" wood with telescopic sub table.
- Rip fence with very smooth sliding movement with anti-lifting T-shaped rail.
- Side and rear extension tables available as option



<b>Continuous rating Input</b>	1,650W
<b>Capacity</b>	at 90° degrees : 91mm at 45° degrees : 63mm
<b>Blade diameter</b>	255mm
<b>Blade bore</b>	15.88 / 25.4mm
<b>No load speed</b>	4,800rpm
<b>Bevel cutting capacity (degrees)</b>	-0.5 - 45.5
<b>Dimensions (L x W x H)</b>	665 x 766 x 344mm
<b>Net weight</b>	34.9kg
<b>Power supply cord</b>	2.5m

**Standard Equipment:** Rip Fence, Miter Gauge, Wrenches , Push Stick, Ring

NAILERS / STAPLERS
--------------------

**2703 255mm (10")** 

**Table Saw**



**Smooth precision cutting on a large table; 686 x 560mm (27" x 22")**

- Riving knife moves together with saw blade.
- Powerful 1,650W motor.
- Lightweight (18kg) for easy transportation

 **153mm**

<b>Continuous rating Input</b>	1,650W
<b>Max cutting capacity</b>	at 0 degrees : 91mm (3-9/16") at 45 degrees : 63mm (2-1/2")
<b>Blade diameter</b>	255mm (10")
<b>Blade bore</b>	15.88 / 30mm (Ring 16)
<b>No load speed (rpm)</b>	4,600rpm
<b>Dimensions (L x W x H)</b>	686 x 560 x 308mm (27" x 22" x 12-1/8")
<b>Net weight</b>	18.0kg (39.6 lbs)
<b>Power supply cord</b>	2.5m (8.2ft)

**Standard Equipment:** Rip Fence, Miter Gauge, Offset Wrench, Wrench, Holder Cap Opener

HEAT GUN / LASER
------------------

CLEANING
----------

OPE
-----

JOBSITE TOOLS
---------------



SPECIALTY TOOLS
-----------------

HAND TOOLS / COMBINATION SET
------------------------------

TOOL HOLDERS AND POUCHES / MAKPAC SYSTEM
--

**LB1200F** 

**Band Saw**

**High efficiency**

- Job light is convenient in dark place
- Easy to replace bandsaw blade by one touch lever
- Dust box is provided
- Easy to move with casters

 **419mm**

<b>Continuous rating Input</b>	900W
<b>Capacity</b>	Thickness of cut : 165mm (6-1/2") Throat : 305mm (12")
<b>Blade speed</b>	Hi : (50Hz)800 (60Hz)1,000m (50Hz)2,624 (60Hz) 3,280ft / min Lo : (50Hz)400 (60Hz)500m (50Hz)1,312 (60Hz) 1,640ft / min
<b>Dimensions (L x W x H)</b>	615 x 775 x 1,600mm (24-1/4" x 30-1/2" x 63")
<b>Net weight</b>	81.2kg (179.0lbs)
<b>Power supply cord</b>	2.5m (8.2ft)

**Standard Equipment:** Rip Fence, Angle Rule, Push Stick, Hex Wrench

Circular Saw



- DRILLING / FIXING
- CONCRETE DRILLING / DEMOLITION
- MIXING / STIRRING
- CUTTING (CONCRETE / METAL)
- GRINDING
- SANDING / POLISHING
- SAWING**
- MULTI-TOOL
- ROUTERS / PLANERS
- NAILERS / STAPLERS
- HEAT GUN / LASER
- CLEANING
- OPE
- JOB SITE TOOLS
- SPECIALTY TOOLS
- HAND TOOLS / COMBINATION SET
- TOOL HOLDERS AND POUCHES / MAKPAC SYSTEM

CIRCULAR SAW RANGE

	415mm	355mm	260-270mm	235mm	185 - 190mm	165mm	85mm
XGT			HS011G 40V MAX (Bore size: 25mm)  RS002G <sup>(260mm)</sup> 40V MAX (REAR HANDLE) (Bore size: 25mm)	HS009G 40V MAX (Bore size: 25mm)	HS004G 40V MAX (Bore size: 20mm)  RS001G <sup>(185mm)</sup> 40V MAX (REAR HANDLE) (Bore size: 20mm)	HS012G 40V MAX (Bore size: 20mm)  SP001G 40V MAX (PLUNGE CUT) (Bore size: 20mm)	
LXT				DHS900 18V X 2 LXT (Bore size: 25mm)	DHS783 18V X 2 LXT (Bore size: 20mm)  DRS780 <sup>(185mm)</sup> 18V LXT (REAR HANDLE) (Bore size: 20mm)	DHS660 DHS661 DHS680 18V LXT (Bore size: 20mm)  DSP600 DSP601 18V X 2 LXT (PLUNGE CUT) (Bore size: 20mm)	
CXT							HS301D 12V MAX CXT (Bore size: 15mm)
AC	5402 1,750W (Bore size: 25mm)	5143R 2,200W (Bore size: 30mm)	HS0600 2,000W (Bore size: 25mm)	N5900B 2,000W (Bore size: 30mm)	HS7010 1,600W (Bore size: 20mm)  5007N <sup>(185mm)</sup> 1,800W (Bore size: 20mm)  5800NB <sup>(180mm)</sup> 900W (Bore size: 20mm)	SP6000 (PLUNGE CUT) (Bore size: 20mm)	

DRILLING / FIXING
CONCRETE DRILLING / DEMOLITION
MIXING / STIRRING
CUTTING (CONCRETE / METAL)
GRINDING
SANDING / POLISHING
<b>SAWING</b>

**HS011G** 260-270mm **40V MAX | XGT**

**40V MAX XGT - Cordless Circular Saw**

**BLADE POSITION RIGHT HAND**



- Max cutting depth: 101mm
- With a maximum bevel capacity of 1° left and 60° right, positive stops at 22.5° and 45°.
- Work amount : Approx 40 cuts (Material: 90mm x 10v00mm Oak wood with fully charged 5.0Ah XGT battery)
- Die-cast magnesium base, blade guard, and blade cover provide a lightweight and durable design



<b>Blade Diameter</b>	260 - 270 mm
<b>Bore Diameter</b>	25mm / 25.4mm
<b>Max Cutting Capacity</b>	0°: 97 - 101 mm / 45°: 68 - 71 mm
<b>No Load Speed (RPM)</b>	3,500
<b>Dimensions (L x W x H)</b>	453 x 196 x 336 mm
<b>Net weight</b>	4.8 kg (without battery)

**Standard Equipment:** Sub Base, Hex Wrench

**AVAILABLE VARIANTS**

5.0Ah	"Z" VARIANT
<b>HS011G T2</b> INCLUDES 2 BATTERIES / 1 CHARGER / / MAKPAC CONNECTOR CASE	<b>HS011G Z</b> TOOL ONLY (DOES NOT INCLUDE BATTERY / CHARGER / / CARRYING CASE)

MULTI-TOOL
ROUTERS / PLANERS

**HS009G** 235mm **40V MAX | XGT**

**Cordless Circular Saw**

**BLADE POSITION RIGHT HAND**



- Max cutting depth: 85mm
- With a maximum bevel capacity of 1° left and 60° right, positive stops at 22.5° and 45°.
- Work amount : Approx 120 cuts (Material: 80mm x 300mm Oak wood with fully charged 5.0Ah XGT battery)
- Die-cast magnesium base, blade guard, and blade cover provide a lightweight and durable design



<b>Blade Diameter</b>	235 mm
<b>Bore Diameter</b>	20mm
<b>Max Cutting Capacity</b>	0°: 85 mm / 45°: 61 mm / 60°: 44 mm
<b>No Load Speed (RPM)</b>	4,000
<b>Dimensions (L x W x H)</b>	413 x 196 x 316 mm
<b>Net weight</b>	4.3 kg (without battery)

**Standard Equipment:** Sub Base, Hex Wrench

**AVAILABLE VARIANTS**

5.0Ah	"Z" VARIANT
<b>HS009G T2</b> INCLUDES 2 BATTERIES / 1 CHARGER / / MAKPAC CONNECTOR CASE	<b>HS009G Z</b> TOOL ONLY (DOES NOT INCLUDE BATTERY / CHARGER / / CARRYING CASE)

NAILERS / STAPLERS
HEAT GUN / LASER

**HS004G** 185-190mm **40V MAX | XGT**

**Cordless Circular Saw**

**BLADE POSITION RIGHT HAND**



- Max cutting depth: 62.5mm
- With a maximum bevel capacity of 0°- 48°, positive stops at 22.5° and 45°.
- Work amount : Approx 145 cuts (Material: 60mm x 300mm Melapi with fully charged 4.0Ah XGT battery)
- Die-cast magnesium base, blade guard, and blade cover provide a lightweight and durable design
- Automatic torque Drive Technology (ADT) adjusts cutting speed and torque during cut for optimum performance
- ADT indicator lamp: Blinks green to indicate that the tool is overloaded



<b>Blade Diameter</b>	190 / 185 mm
<b>Bore Diameter</b>	20mm
<b>Max Cutting Capacity</b>	0°: 62.5 / 60 mm 45°: 44.5 / 43 mm 48°: 42 / 41 mm
<b>No Load Speed (RPM)</b>	6,000
<b>Dimensions (L x W x H)</b>	337x210x290 mm
<b>Net weight</b>	3.4 kg (without battery)

**Standard Equipment:** Hex Wrench, Guide Rule

**AVAILABLE VARIANTS**

4.0Ah	"Z" VARIANT
<b>HS004G M2</b> INCLUDES 2 BATTERIES / 1 CHARGER / BLUETOOTH CHIP / MAKPAC CONNECTOR CASE	<b>HS004G Z</b> TOOL ONLY (DOES NOT INCLUDE BATTERY / CHARGER / BLUETOOTH CHIP / CARRYING CASE)

CLEANING
OPE

**HS012G** 165mm **40V MAX | XGT**

**Cordless Circular Saw**

**BLADE POSITION LEFT HAND**



- Max cutting depth: 57mm
- With a maximum bevel capacity of 0-50°, positive stops at 22.5° and 45°.
- Work amount : Approx 110 cuts (Material: 50mm x 300mm Melapi with fully charged 2.5Ah XGT battery)
- Die-cast magnesium base, blade guard, and blade cover provide a lightweight and durable design
- Compatible with guide rail using an adapter



<b>Blade Diameter</b>	165 mm
<b>Bore Diameter</b>	20 mm
<b>Max Cutting Capacity</b>	0°: 57 mm 45°: 41 mm
<b>No Load Speed (RPM)</b>	5,200
<b>Dimensions (L x W x H)</b>	298 x 157 x 246 mm
<b>Net weight</b>	2.48 kg (without battery)

**Standard Equipment:** Guide rule, Dust nozzle, Hex wrench (Optional: Bluetooth chip)

**AVAILABLE VARIANTS**

2.5Ah	"Z" VARIANT
<b>HS012G D2</b> INCLUDES 2 BATTERIES / 1 CHARGER / / MAKPAC CONNECTOR CASE	<b>HS012G Z</b> TOOL ONLY (DOES NOT INCLUDE BATTERY / CHARGER / / CARRYING CASE)

JOBSITE TOOLS
SPECIALTY TOOLS

HAND TOOLS / COMBINATION SET
TOOL HOLDERS AND POUCHES / MAKPAC SYSTEM





**DHS900** 235 mm 18V+18V | *LXT*

**Lithium-ion Cordless Circular Saw**

**BLADE POSITION  
RIGHT HAND**



- Max cutting depth: 85mm
- With a max bevel capacity of 0-50°, positive stops at 22.5° and 45°.
- Work amount : Approx 110 cuts (Material: 80mm x 300mm Oak wood with fully charged 5.0Ah x 2 LXT battery)
- Die-cast magnesium base, blade guard, and blade cover provide a lightweight and durable design.
- Automatic torque Drive Technology (ADT) adjusts cutting speed and torque during cut for optimum performance
- ADT indicator lamp: Blinks green to indicate that the tool is overloaded

<b>Blade Diameter</b>	235 mm
<b>Bore Diameter</b>	30mm
<b>Max Cutting Capacity</b>	90°: 85 mm   45°: 61 mm   60°: 44 mm
<b>No Load Speed (RPM)</b>	4,500
<b>Vibration Level</b>	2.5 m/s <sup>2</sup>
<b>Sound Pressure / Power Level</b>	93 dB(A) / 104 dB(A)
<b>Dimensions (L x W x H)</b>	413x196x316 mm
<b>Net weight</b>	4.6 kg (without battery)

**Standard Equipment:** Hex Wrench

5.0Ah	"Z" VARIANT
<p><b>DHS900 PT2</b> INCLUDES 2 BATTERIES / 1 TWO PORT CHARGER / MAKPAC CONNECTOR CASE (DOES NOT INCLUDE BLUETOOTH CHIP)</p>	<p><b>DHS900 ZU</b> TOOL + BLUETOOTH ONLY (DOES NOT INCLUDE BATTERY / CHARGER / MAKPAC CASE)</p> <p><b>DHS900 Z</b> TOOL ONLY (DOES NOT INCLUDE BATTERY / CHARGER / BLUETOOTH CHIP / MAKPAC CASE)</p>



**DHS783** 185-190mm 18V+18V | *LXT*

**18V + 18V LXT - Lithium-ion Cordless Circular Saw**

**BLADE POSITION  
RIGHT HAND**



- Max cutting depth: 62.5mm
- With a max bevel capacity of 48°, positive stops at 45°
- Work amount : Approx 140 cuts (Material: 50mm x 300mm melapi with fully charged 5.0Ah x 2 LXT battery)
- Die-cast magnesium base, blade guard, and blade cover provide a lightweight and durable design.
- Automatic torque Drive Technology (ADT) adjusts cutting speed and torque during cut for optimum performance
- ADT indicator lamp: Blinks green to indicate that the tool is overloaded

<b>Blade Diameter</b>	190 / 185 mm
<b>Bore Diameter</b>	20mm
<b>Max Cutting Capacity</b>	90°: 62.5 / 60 mm   45°: 44.5 / 43 mm   48°: 42 / 41 mm
<b>No Load Speed (RPM)</b>	6,000
<b>Vibration Level</b>	2.5 m/s <sup>2</sup> or less
<b>Dimensions (L x W x H)</b>	348x210x290 mm
<b>Net weight</b>	3.8 kg (without battery)

**Standard Equipment:** Hex Wrench

5.0Ah	"Z" VARIANT
<p><b>DHS783 T2JU</b> INCLUDES 2 BATTERIES / 1 TWO PORT CHARGER / MAKPAC CONNECTOR CASE + BLUETOOTH CHIP</p>	<p><b>DHS783 ZU</b> TOOL ONLY + BLUETOOTH CHIP (DOES NOT INCLUDE BATTERY / CHARGER + MAKPAC CASE)</p>

**DHS661** 165 mm 18V | *LXT*

**Cordless Circular Saw**

**BLADE POSITION  
RIGHT HAND**



- Max cutting depth: 57mm
- With a max bevel capacity of 50°
- Work amount : Approx 200 cuts (Material: 38mm x 89mm SPF2 x 10 with fully charged 5.0Ah LXT battery)
- Aluminum base plate, Magnesium blade guard, and plastic blade cover
- Automatic torque Drive Technology (ADT) adjusts cutting speed and torque during cut for optimum performance
- ADT indicator lamp: Blinks green to indicate that the tool is overloaded



<b>Blade Diameter</b>	165 mm
<b>Hole Diameter</b>	20 mm
<b>Max Cutting Capacity</b>	90°: 57 mm / 45°: 41 mm / 50°: 37 mm
<b>No Load Speed (RPM)</b>	5,000
<b>Vibration Level</b>	Cutting Wood: 2.5 m/s <sup>2</sup> or less
<b>Sound Pressure / Power Level</b>	93 dB(A) / 104 dB(A)
<b>Dimensions (L x W x H)</b>	270x186x250 mm
<b>Net weight</b>	2.5 kg (without battery)

**Standard Equipment:** Hex wrench, Rip fence, Dust nozzle.

5.0Ah	"Z" VARIANT
<p><b>DHS661 RTJU</b> INCLUDES 2 BATTERIES / 1 CHARGER / BLUETOOTH CHIP / MAKPAC CASE</p>	<p><b>DHS661 ZJU</b> TOOL WITH BLUETOOTH CHIP &amp; MAKPAC CASE (DOES NOT INCLUDE BATTERY / CHARGER)</p>

**DHS660** 165 mm 18V | *LXT*

**Cordless Circular Saw**

**BLADE POSITION  
RIGHT HAND**



- Max cutting depth: 57mm
- With a max bevel capacity of 50°
- Work amount : Approx 200 cuts (Material: 38mm x 89mm SPF2 x 10 with fully charged 5.0Ah LXT battery)
- Aluminum base plate, Magnesium blade guard, and plastic blade cover
- Automatic torque Drive Technology (ADT) adjusts cutting speed and torque during cut for optimum performance
- ADT indicator lamp: Blinks green to indicate that the tool is overloaded



<b>Blade Diameter</b>	165 mm
<b>Hole Diameter</b>	20 mm
<b>Max Cutting Capacity</b>	90°: 57 mm / 45°: 41 mm / 50°: 37 mm
<b>No Load Speed (RPM)</b>	5,000
<b>Vibration Level</b>	Cutting Wood: 2.5 m/s <sup>2</sup> or less
<b>Sound Pressure / Power Level</b>	93 dB(A) / 104 dB(A)
<b>Dimensions (L x W x H)</b>	270x186x250 mm
<b>Net weight</b>	2.5 kg (without battery)

**Standard Equipment:** Hex wrench, Rip fence, Dust nozzle.

5.0Ah	"Z" VARIANT
<p><b>DHS660 RTJ</b> INCLUDES 2 BATTERIES / 1 CHARGER / MAKPAC CONNECTOR CASE</p>	<p><b>DHS660 Z</b> TOOL ONLY (DOES NOT INCLUDE BATTERY / CHARGER OR CARRY CASE)</p>

- DRILLING / FIXING
- CONCRETE DRILLING / DEMOLITION
- MIXING / STIRRING
- CUTTING (CONCRETE / METAL)
- GRINDING
- SANDING / POLISHING
- SAWING
- MULTI-TOOL
- ROUTERS / PLANERS
- NAILERS / STAPLERS
- HEAT GUN / LASER
- CLEANING
- OPE
- JOBSITE TOOLS
- SPECIALTY TOOLS
- HAND TOOLS / COMBINATION SET
- TOOL HOLDERS AND POUCHES / MAKPAC SYSTEM

DRILLING / FIXING
CONCRETE DRILLING / DEMOLITION
MIXING / STIRRING
CUTTING (CONCRETE / METAL)
GRINDING
SANDING / POLISHING
<b>SAWING</b>

**DHS680** 165mm 18V | **LXT**

**Cordless Circular Saw**

[BLADE POSITION LEFT HAND](#)



- Max cutting depth: 57mm
- With a max bevel capacity of 50°
- Work amount : Approx 125 cuts (Material: 38mm x 235mm SPF2 x 10 with fully charged 3.0Ah LXT battery)
- Die-cast magnesium base, blade guard, and blade cover provide a lightweight and durable design.
- Automatic torque Drive Technology (ADT) adjusts cutting speed and torque during cut for optimum performance
- ADT indicator lamp: Blinks green to indicate that the tool is overloaded



<b>Max cutting capacity</b>	at 0 degrees : 57mm   at 45 degrees : 41mm   at 50 degrees : 37mm
<b>Blade diameter</b>	165mm
<b>Bore diameter</b>	20mm
<b>No load speed (rpm)</b>	5,000
<b>Dimensions (L x W x H)</b>	350x170x238mm
<b>Net weight</b>	2.62kg

**Standard Equipment:** Hex wrench, Rip fence, Dust nozzle.

**AVAILABLE VARIANTS**

	3.0Ah	"Z" VARIANT
<b>DHS680 RTJ</b> INCLUDES 2 BATTERIES / 1 CHARGER / MAKPAC CONNECTOR CASE	<b>DHS680 RFJ</b> INCLUDES 2 BATTERIES / 1 CHARGER / MAKPAC CONNECTOR CASE	<b>DHS680 Z</b> TOOL ONLY (DOES NOT INCLUDE BATTERY / CHARGER OR CARRY CASE)

MULTI-TOOL
ROUTERS / PLANERS

**HS301D** 85mm 12V MAX | **CXT**

**Cordless Circular Saw**

[BLADE POSITION RIGHT HAND](#)



**Compact and Handy**

- Max cutting depth: 25.5mm
- With a max bevel capacity of 45°
- Work amount : Approx 125 cuts (Material: 12mm x 300mm plywood with fully charged 2.0Ah CXT battery)



<b>Max cutting capacity</b>	at 0 degrees : 25.5mm   at 45 degrees : 16.5mm
<b>Blade diameter</b>	85mm
<b>Bore diameter</b>	15mm
<b>No load speed (rpm)</b>	1,500
<b>Dimensions (L x W x H)</b>	313x170x155mm
<b>Net weight</b>	1.6kg

**Standard Equipment:** Hex wrench, Dust nozzle

**AVAILABLE VARIANTS**

4.0Ah	2.0Ah	"Z" Version
	<b>HS301D WAE</b> INCLUDES 2 BATTERIES / 1 CHARGER / CARRYING CASE	<b>HS301D Z</b> TOOL ONLY (DOES NOT INCLUDE BATTERY / CHARGER OR CARRY CASE)

NAILERS / STAPLERS
HEAT GUN / LASER
CLEANING
OPE
JOB SITE TOOLS
SPECIALTY TOOLS
HAND TOOLS / COMBINATION SET
TOOL HOLDERS AND POUCHES / MAKPAC SYSTEM

**5402** 415mm 

**Circular Saw**

[BLADE POSITION RIGHT HAND](#)



**The biggest portable ever**

- Yet, surprisingly light at 14kg (30.8lbs) for easy wood cutting
- Cuts 157mm (6-3/16") at 90 degrees and 106mm (4-3/16") at 45 degrees



<b>Continuous rating Input</b>	1,750W
<b>Capacity</b>	at 0 degrees : 157mm at 45 degrees : 106mm
<b>Blade diameter</b>	415mm
<b>Blade bore</b>	25mm
<b>No load speed</b>	2,200rpm
<b>Overall length</b>	615mm
<b>Net weight</b>	13.6kg
<b>Power supply cord</b>	5.0m

**Standard Equipment:** Wrench, Hex Wrench, Rip Fence (Guide Rule)

**5143R** 355mm 

**Circular Saw**

[BLADE POSITION RIGHT HAND](#)



**355 mm SJS Circular Saw, Electric Brake, Soft Start**

- Equipped with SJS (Super Joint System)
- More efficient chip/sawdust ejection
- With anti kickback riving knife
- Two parallel gauge can fix material securely
- Safety cover with roller makes feeding of material smooth and prevents score on surface of material
- Flat-end motor housing for easy blade changes



<b>Continuous rating input</b>	2,200W
<b>Blade Diameter</b>	355 mm (14")
<b>Max Cutting Capacity</b>	90°: 130 mm 45°: 90 mm
<b>No Load Speed (RPM)</b>	2,700
<b>Overall Length</b>	607 mm
<b>Net weight</b>	12.5 kg
<b>Power supply cord</b>	5.0 m

**Standard Equipment:** Hex Wrench, Rip Fence (Guide Rule)

**HS0600** 260mm / 270mm 

**Circular Saw**

**BLADE POSITION  
RIGHT HAND**



**Enables single-pass cutting of 89 mm 4x materials**

- Enables single-pass cutting of 89 mm 4x materials
- Large cutting capacity 97 mm at 90° with 260 mm blade, 101 mm at 90° with 270 mm blade and bevel capacity (0°-50°)
- Magnesium components create a lightweight saw that is well balanced and job site tough
- Fine parallel adjustment of the base plate to the saw blade
- Compatible with optional guide rail for increased maneuverability



Continuous rating input	2,000W
Blade Diameter	260 / 270 mm
Max Cutting Capacity	0°: 97 / 101 mm 45°: 68 / 71 mm 50°: 61 / 63 mm
No Load Speed (RPM)	4,300
Vibration Level	Cutting Wood: 2.5 m/s <sup>2</sup> or less
Sound Pressure Level	94 dB(A)
Sound Power Level	105 dB(A)
Dimensions (L x W x H)	418x273x324 mm
Net weight	6.9 kg
Power supply cord	2.5 m

**Standard Equipment:** Rip Fence (Guide Rule), Hex Wrench

**N5900B** 235mm 

**Circular Saw**

**BLADE POSITION  
RIGHT HAND**



**Provides enough power to rip through most materials**

- Sturdy steel safety cover with industrial durability
- High rigidity of rugged steel base provides stability
- Flat-end motor housing for easy blade changes



Continuous rating Input	220V: 2,000W / 127V: 1,650W
Capacity	at 0 degrees : 85mm at 45 degrees : 60mm at 50 degrees : 53mm
Blade diameter	235mm
Blade bore	30 mm
No load speed	4,100rpm
Overall length	380mm
Net weight	7.2kg
Power supply cord	2.5m

**Standard Equipment:** Guide Rule, Wrench 13

**HS7010** 185mm 

**Circular Saw**

**BLADE POSITION  
RIGHT HAND**



**High Power and Increased Motor-Burnout Resistance**

- Faster cutting
- High Motor durability
- Powerful 1,600 W motor delivers 5,500 RPM for increased performance and job site durability



Continuous rating input	1,600W
Blade Diameter	185 / 190 mm
Max Cutting Capacity	0°: 65 / 67 mm 45°: 44 / 45 mm
No Load Speed (RPM)	5,500
Dimensions (L x W x H)	300x240x261 mm
Net weight	4.0 kg
Power supply cord	2.5 m

**Standard Equipment:** Rip Fence (Guide Rule), Hex Wrench, Dust Nozzle

**5007N** 185mm 

**Circular Saw**

**BLADE POSITION  
RIGHT HAND**



**Designed for all-round easier operation**

- Powerful 1,800W motor for heavy duty applications.
- Large wrap-around aluminum base and superb cross cut or rip sawing actions
- Rubberized soft grip provides more comfort and control



Continuous rating Input	1,800W
Capacity	at 0 degrees : 63.5mm at 45 degrees : 45mm at 56 degrees : 35mm
Blade diameter	185mm
Blade bore	20mm
No load speed (rpm)	5,800
Overall length	317mm
Net weight	5.2kg
Power supply cord	2.5m

**Standard Equipment:** Hex Wrench, Guide Rule

- DRILLING / FIXING
- CONCRETE DRILLING / DEMOLITION
- MIXING / STIRRING
- CUTTING (CONCRETE / METAL)
- GRINDING
- SANDING / POLISHING
- SAWING**
- MULTI-TOOL
- ROUTERS / PLANERS
- NAILERS / STAPLERS
- HEAT GUN / LASER
- CLEANING
- OPE
- JOB SITE TOOLS
- SPECIALTY TOOLS
- HAND TOOLS / COMBINATION SET
- TOOL HOLDERS AND POUCHES / MAKPAC SYSTEM

- DRILLING / FIXING
- CONCRETE DRILLING / DEMOLITION
- MIXING / STIRRING
- CUTTING (CONCRETE / METAL)
- GRINDING
- SANDING / POLISHING
- SAWING
- MULTI-TOOL

5800NB 180mm
-AC

Circular Saw



BLADE POSITION  
RIGHT HAND

One of our best-selling portable circular saws

- Double insulation structure



<b>Continuous rating Input</b>	900W
<b>Capacity</b>	at 0 degrees : 64mm (2-1/2") at 45 degrees : 43mm (1-11/16")
<b>Blade diameter</b>	180mm (7-1/8")
<b>Blade bore</b>	20mm
<b>No load speed</b>	4,500rpm
<b>Overall length</b>	272mm (10-3/4")
<b>Net weight</b>	3.5kg (7.7lbs)
<b>Power supply cord</b>	5.0m (16.4ft)

**Standard Equipment:** Socket Wrench, Rip Fence (Guide Rule)



- ROUTERS / PLANERS
- NAILERS / STAPLERS
- HEAT GUN / LASER
- CLEANING
- OPE
- JOBSITE TOOLS
- SPECIALTY TOOLS
- HAND TOOLS / COMBINATION SET
- TOOL HOLDERS AND POUCHES / MAKPAC SYSTEM

RS002G 260mm
40V MAX | XGT

Cordless Rear Handle Circular Saw



BLADE POSITION  
LEFT HAND

Cuts 4X the material in a single pass with a large cutting capacity 95mm

- With a max bevel capacity of 56°, positive stops at 22.5° and 45°.
- Work amount : Approx 80 cuts (Material: 90mm x 300mm Melapi with fully charged 5.0Ah XGT battery)
- Die-cast magnesium base, blade guard, and blade cover provide a lightweight and durable design.



<b>Blade Diameter</b>	260 mm
<b>Bore diameter</b>	25mm
<b>Max Cutting Capacity</b>	90°: 95 mm   45°: 70 mm   56°: 54.5 mm
<b>No Load Speed (RPM)</b>	4,000
<b>Vibration Level</b>	2.5m/s <sup>2</sup> or less
<b>Sound Pressure Level / Sound Power Level</b>	96 dB(A) / 107dB(A)
<b>Dimensions (L x W x H)</b>	489 x 193 x 309 mm
<b>Net weight</b>	5.0kg (without battery)

**Standard Equipment:** Offset Wrench

AVAILABLE VARIANTS

5.0Ah	"Z" VARIANT
<b>RS002G T1</b> INCLUDES 1 BATTERY / 1 CHARGER / / MAKPAC CONNECTOR CASE	<b>RS002G Z</b> TOOL ONLY (DOES NOT INCLUDE BATTERY / CHARGER / / CARRYING CASE)

RS001G 185mm
40V MAX | XGT

Cordless Rear Handle Circular Saw



BLADE POSITION  
LEFT HAND

Cuts 3X the material in a single pass with a large cutting capacity 65mm

- With a max bevel capacity of 53°, positive stops at 22.5° and 45°.
- Work amount : Approx 165 cuts (Material: 60mm x 300mm Melapi with fully charged 5.0Ah XGT battery)
- Die-cast magnesium base, blade guard, and blade cover provide a lightweight and durable design.
- Automatic torque Drive Technology (ADT) adjusts cutting speed and torque during cut for optimum performance



<b>Blade Diameter</b>	185 mm
<b>Bore diameter</b>	20mm
<b>Max Cutting Capacity</b>	90°: 65 mm   45°: 45 mm   53°: 38 mm
<b>No Load Speed (RPM)</b>	6,400
<b>Vibration Level</b>	2.5 m/s <sup>2</sup> or less
<b>Sound Pressure Level / Sound Power Level</b>	92 dB(A) / 103 dB(A)
<b>Dimensions (L x W x H)</b>	446 x 196 x 270 mm
<b>Net weight</b>	4.3 kg (without battery)

**Standard Equipment:** Offset Wrench

AVAILABLE VARIANTS

5.0Ah	"Z" VARIANT
<b>RS001G T1</b> INCLUDES 1 BATTERY / 1 CHARGER / / MAKPAC CONNECTOR CASE	<b>RS001G Z</b> TOOL ONLY (DOES NOT INCLUDE BATTERY / CHARGER / / CARRYING CASE)

**DRS780** 185mm 18V | **LXT**

**Cordless Rear Handle Saw**



**BLADE POSITION  
LEFT HAND**

**Cuts 3X the material in a single pass with a large cutting capacity 65mm**

- With a max bevel capacity of 53°, positive stops at 22.5° and 45°.
- Work amount : Approx 160 cuts (Material: 50mm x 300mm Melapi with fully charged 5.0Ah x2 LXT battery)
- Die-cast magnesium base, blade guard, and blade cover provide a lightweight and durable design.
- Automatic torque Drive Technology (ADT) adjusts cutting speed and torque during cut for optimum performance

<b>Blade Diameter</b>	185 mm
<b>Max Cutting Capacity</b>	90°: 65 mm 45°: 45 mm 53°: 38 mm
<b>No Load Speed (RPM)</b>	5,100
<b>Dimensions (L x W x H)</b>	446x196x270mm
<b>Net weight</b>	5.6 kg

**Standard Equipment:** Offset Wrench

**AVAILABLE VARIANTS**

**"Z" VARIANT**

**DRS780 Z**  
TOOL ONLY  
(DOES NOT INCLUDE BATTERY / CHARGER)

**PLUNGE CUT CIRCULAR SAW**



**SP001G** 165mm 40V MAX | **XGT**

**Cordless Plunge Cut Circular Saw**



**Tool be sold along with guide Rail**

1.4 m: 194368-5  
3.0 m: 194367-7

**High power for fast and accurate cutting and ripping**

- With cutting speeds 10% faster than the 18Vx2 equivalent and 40% faster than the AC equivalent.
- Large cutting capacity 56 mm at 90°and bevel capacity (-1° - 48°) with a positive stop at 22.5°
- Compatible with optional guide rail system for ultra precise straight cutting
- Dual front and rear bevel lock provide additional rigidity for accurate bevel cuts
- Depth stopper for splinter-free cutting enables to easily cut a preliminary groove at a depth of 2 mm
- Easy to set depth adjustment with large scale
- Magnesium components deliver a well balanced and lightweight saw

<b>Wheel Diameter</b>	165 mm (6-1/2")
<b>Bore Diameter</b>	20 mm (13/16")
<b>Bevel Capacity</b>	-1 - 48°
<b>Max Cutting Capacity</b>	0°: 56 mm / 45°: 40 mm / 48°: 38 mm
<b>No Load Speed (RPM)</b>	2,500 - 4,900
<b>Dimensions (L x W x H)</b>	347 x 221 x 271 mm
<b>Net weight</b>	3.7 kg (without battery)

**Standard Equipment:** Hex Wrench

**AVAILABLE VARIANTS**

**"Z" VARIANT**

**SP001G Z**  
TOOL ONLY  
(DOES NOT INCLUDE BATTERY / CHARGER / BLUETOOTH CHIP / CARRYING CASE)

**DSP601** 165mm 18Vx2 | **LXT**

**Cordless Plunge Cut Circular Saw**



**Tool be sold along with guide Rail**

1.4 m: 194368-5  
3.0 m: 194367-7

**Precision accurate cutting delivers a splinter-free mirror finish**

- Up to 40% Faster Cutting than Corded Model SP6000
- Large cutting capacity 56 mm at 90°and bevel capacity (-1° - 48°) with a positive stop at 22.5°
- Compatible with optional guide rail system for ultra precise straight cutting
- Dual front and rear bevel lock provide additional rigidity for accurate bevel cuts
- Depth stopper for splinter-free cutting enables to easily cut a preliminary groove at a depth of 2 mm
- Easy to set depth adjustment with large scale
- Magnesium components deliver a well balanced and lightweight saw

<b>Wheel Diameter</b>	165 mm
<b>Bore Diameter</b>	90°: 56 mm
<b>Bevel Capacity</b>	45°: 40 mm
<b>Max Cutting Capacity</b>	48°: 38 mm
<b>No Load Speed (RPM)</b>	2,500 - 6,300
<b>Dimensions (L x W x H)</b>	346x241x272 mm
<b>Net weight</b>	3.7 kg (without battery)

**Standard Equipment:** Hex Wrench

**AVAILABLE VARIANTS**

**"Z" VARIANT**

**DSP601 Z**  
TOOL ONLY  
(DOES NOT INCLUDE BATTERY / CHARGER / BLUETOOTH CHIP / CARRYING CASE)

- DRILLING / FIXING
- CONCRETE DRILLING / DEMOLITION
- MIXING / STIRRING
- CUTTING (CONCRETE / METAL)
- GRINDING
- SANDING / POLISHING
- SAWING
- MULTI-TOOL
- ROUTERS / PLANERS
- NAILERS / STAPLERS
- HEAT GUN / LASER
- CLEANING
- OPE
- JOB SITE TOOLS
- SPECIALTY TOOLS
- HAND TOOLS / COMBINATION SET
- TOOL HOLDERS AND POUCHES / MAKPAC SYSTEM

- DRILLING / FIXING
- CONCRETE DRILLING / DEMOLITION
- MIXING / STIRRING
- CUTTING (CONCRETE / METAL)
- GRINDING
- SANDING / POLISHING
- SAWING
- MULTI-TOOL
- ROUTERS / PLANERS
- NAILERS / STAPLERS
- HEAT GUN / LASER
- CLEANING
- OPE
- JOBSITE TOOLS
- SPECIALTY TOOLS
- HAND TOOLS / COMBINATION SET
- TOOL HOLDERS AND POUCHES / MAKPAC SYSTEM

DSP600 165mm
 18Vx2 **LXT**

Cordless Plunge Cut Circular Saw



Tool be sold along with guide Rail

1.4 m: 194368-5

3.0 m: 194367-7

**Precision accurate cutting delivers a splinter-free mirror finish**

- Up to 40% Faster Cutting than Corded Model SP6000
- Large cutting capacity 56 mm at 90° and bevel capacity (-1° - 48°) with a positive stop at 22.5°
- Compatible with optional guide rail system for ultra precise straight cutting
- Dual front and rear bevel lock provide additional rigidity for accurate bevel cuts
- Depth stopper for splinter-free cutting enables to easily cut a preliminary groove at a depth of 2 mm
- Easy to set depth adjustment with large scale
- Magnesium components deliver a well balanced and lightweight saw

	
Wheel Diameter	165 mm
Bore Diameter	90°: 56 mm
Bevel Capacity	45°: 40 mm
Max Cutting Capacity	48°: 38 mm
No Load Speed (RPM)	2,500 - 6,300
Dimensions (L x W x H)	346x241x272 mm
Net weight	3.7 kg (without battery)

**Standard Equipment:** Hex Wrench

AVAILABLE VARIANTS

"Z" VARIANT

**DSP600 Z**

TOOL ONLY  
(DOES NOT INCLUDE BATTERY / CHARGER / BLUETOOTH CHIP / CARRYING CASE)

SP6000 165mm
 AC

Plunge Cut Circular Saw



Tool be sold along with guide Rail

1.4 m: 194368-5

3.0 m: 194367-7

**High accurate, clean cutting**

- Large cutting capacity 56 mm at 90° and bevel capacity (-1° - 48°) with a positive stop at 22.5°
- Depth stopper for splinter-free cutting enables to easily cut a preliminary groove at a depth of 2mm
- Compatible with optional guide rail system for ultra precise straight cutting
- Dual front and rear bevel lock provide additional rigidity for accurate bevel cuts
- Easy to set depth adjustment with large scale
- Magnesium components deliver a well balanced and lightweight saw



<b>Continuous rating Input</b>	1,300W
<b>Capacity</b>	at 0 degrees : 56mm (2-3/16")
	at 45 degrees : 40mm (1-9/16")
	at 48 degrees : 38mm (1-1/2")
<b>Blade diameter</b>	165mm (6-1/2")
<b>Blade bore</b>	20mm
<b>No load speed (rpm)</b>	2,000 - 5,200
<b>Dimensions (L x W x H)</b>	341 x 225 x 250mm (13-3/8" x 8-7/8" x 9-7/8")
<b>Net weight</b>	4.4kg (9.7lbs)
<b>Power supply cord</b>	2.5m (8.2ft)

**Standard Equipment:** Hex Wrench, Guide Rule

JIGSAW



JV001G
40V MAX | **XGT**

Cordless Jig Saw

NEW



**High accuracy / efficiency, 3 Orbital Settings + Straight Cutting**

- More efficient than equivalent AC & LXT models, allowing for smooth and efficient cutting of 48mm thick MDF
- Higher user-friendliness has been achieved by adding light reduction function, redesigning tool body shape and more
- New Soft no-load with disabling function
  - Easy, precise alignment of blade with pencil line at cut starting point
  - If the tool detects no-load motor rotation during intermittent operation such as precision cut-out, it switches automatically back to Soft no-load mode
- Less wobbling - Improved stability during cutting due to a wider base plate
- Toolless blade clamp (with a blade holder which allows for one-hand blade change)



<b>Capacity</b>	Wood: 135 mm
	Steel: 10 mm
	Aluminum: 20 mm
<b>Length of stroke</b>	26 mm
<b>Strokes per minute (spm)</b>	800 - 3,500
<b>Bevel range</b>	0 - 45°
<b>Dimensions (L x W x H)</b>	269 x 84 x 189 mm
<b>Net weight</b>	1.9 kg (without battery)

**Standard Equipment:** Cover Plate, Anti-Splintering Device, Hex Wrench.

AVAILABLE VARIANTS

<b>4.0Ah</b>	<b>"Z" VARIANT</b>
<b>JV001G M2</b> INCLUDES 2 BATTERIES / 1 CHARGER // MAKPAC CASE	<b>JV001 Z</b> TOOL ONLY (DOES NOT INCLUDE BATTERY / CHARGER OR CARRY CASE)

**DJV184** 18V | **LXT**

**Cordless Jig Saw**



**3 Orbital Settings Plus Straight Cutting**

- Soft no-load speed mode (with disabling function) reduce vibration and aligns blade with the cutting line easily
- Anti-malfunction switch
- Compact and Lightweight
- Toolless blade clamp



<b>Capacity</b>	Wood: 135 mm Steel: 10 mm Aluminium: 20 mm
<b>Length of Stroke</b>	23 mm
<b>Strokes Per Minute (SPM)</b>	0 - 3,000
<b>Dimensions (L x W x H)</b>	259 x 78 x 205 mm
<b>Net weight</b>	1.8 kg (without battery)

**Standard Equipment:** Cover Plate, Hex Wrench.

**AVAILABLE VARIANTS**

<b>3.0Ah</b>	<b>"Z" VARIANT</b>
<b>DJV184 RFJ</b> INCLUDES 2 BATTERIES / 1 CHARGER / MAKPAC CONNECTOR CASE	<b>DJV184 Z</b> TOOL ONLY (DOES NOT INCLUDE BATTERY / CHARGER OR CARRY CASE)

**DJV180** 18V | **LXT**

**Cordless Jig Saw**



**High accuracy and high efficiency.**

- Low vibration and low noise.
- Toolless push-in lock system enables extremely quick blade changes.
- Rubber Dust Seal at Rod and Retainer shuts out dust.
- Large trigger switch is easy to operate with gloved hand.
- Ergonomically designed handle with rubberized soft grip provides more control and comfort.



<b>Capacity</b>	Wood : 135mm (5-5/16") Steel : 10mm (3/8")
<b>Length of stroke</b>	26mm (1")
<b>Strokes per minute (spm)</b>	0-2,600
<b>Dimensions (L x W x H)</b>	257x73x208mm (10-1/8"x2-7/8"x8-3/16")
<b>Net weight</b>	2.8kg (6.1lbs)

**Standard Equipment:** Cover Plate, Anti-Splintering Device, Hex Wrench.

**AVAILABLE VARIANTS**

<b>"Z" VARIANT</b>
<b>DJV180 Z</b> TOOL ONLY (DOES NOT INCLUDE BATTERY / CHARGER OR CARRY CASE)

**JV103D** 12V MAX | **CXT**

**Cordless Jig Saw**



**Top handle model most often used for single hand operation**

- Faster Cutting and Longer Runtime
- Disabling soft no-load rotation function in operator's preference
- Soft no-load rotation reduces vibration and aligns blade with the cutting line easily
- Toolless blade clamp for easy blade change
- Independent dust nozzle can be attached for connection to Makita vacuum cleaner and doesn't require to be removed even when bevel cutting



<b>Capacity</b>	Wood / Aluminum / Mild Steel: 90 / 20 / 10 mm
<b>Length of stroke</b>	23 mm
<b>Strokes per minute (spm)</b>	800 - 3,000
<b>Dimensions (L x W x H)</b>	237x76x206 mm
<b>Net weight</b>	1.9 kg

**Standard Equipment:** Hex Wrench, Dust Nozzle, Dust Cover, Cover Plate

**AVAILABLE VARIANTS**

<b>2.0Ah</b>	<b>"Z" Version</b>
<b>JV103D SA1J</b> INCLUDES 1 BATTERY / 1 CHARGER / MAKPAC CONNECTOR CASE	<b>JV103D Z</b> TOOL ONLY (DOES NOT INCLUDE BATTERY / CHARGER OR CARRY CASE)

**JV102D (Barrel handle)** 12V MAX | **CXT**

**Cordless Jig Saw**



**The barrel grip with raised front pommel which allows two-handed control of the machine**

- Faster Cutting and Longer Runtime
- Disabling soft no-load rotation function in operator's preference
- Soft no-load rotation reduces vibration and aligns blade with the cutting line easily
- Toolless blade clamp for easy blade change
- Independent dust nozzle can be attached for connection to Makita vacuum cleaner and doesn't require to be removed even when bevel cutting



<b>Max cutting capacity</b>	Wood / Aluminum / Mild Steel: 90 / 20 / 10 mm
<b>Length of Stroke</b>	23 mm
<b>Strokes Per Minute (SPM)</b>	800 - 3,000
<b>Dimensions (L x W x H)</b>	237x76x186 mm
<b>Net weight</b>	1.9 kg

**Standard Equipment:** Hex Wrench, Dust Nozzle, Dust Cover, Cover Plate

**AVAILABLE VARIANTS**

<b>2.0Ah</b>	<b>"Z" Version</b>
<b>JV102D SA1J</b> INCLUDES 1 BATTERY / 1 CHARGER / MAKPAC CONNECTOR CASE	<b>JV102D Z</b> TOOL ONLY (DOES NOT INCLUDE BATTERY / CHARGER OR CARRY CASE)

DRILLING / FIXING

CONCRETE DRILLING / DEMOLITION

MIXING / STIRRING

CUTTING (CONCRETE / METAL)

GRINDING

SAWING

SANDING / POLISHING

MULTI-TOOL

ROUTERS / PLANERS

NAILERS / STAPLERS

HEAT GUN / LASER

CLEANING

OPE

JOB SITE TOOLS

SPECIALTY TOOLS

HAND TOOLS / COMBINATION SET

TOOL HOLDERS AND POUCHES / MAKPAC SYSTEM

- DRILLING / FIXING
- CONCRETE DRILLING / DEMOLITION
- MIXING / STIRRING
- CUTTING (CONCRETE / METAL)
- GRINDING
- SANDING / POLISHING
- SAWING



JV101D
12V MAX | CXT

**Cordless Jig Saw**



**Compact and lightweight body optimum for light duty cutting**

- Ergonomically designed handle provides more control and comfort.
- Rigid aluminum base bevels 0 to 45 degrees left and right
- Change lever for 3 orbital settings and straight cutting

<b>Capacity</b>	Wood : 65mm (2-9/16") Steel : 2mm (1/16")
<b>Length of stroke</b>	18mm (11/16")
<b>Strokes per minute (spm)</b>	0-2,850
<b>Dimensions (L x W x H)</b>	232x76x196mm
<b>Net weight</b>	1.8kg

**Standard Equipment:** Hex wrench

AVAILABLE VARIANTS

4.0Ah	2.0Ah	"Z" Version
		<b>JV101D Z</b> TOOL ONLY (DOES NOT INCLUDE BATTERY / CHARGER OR CARRY CASE)

- MULTI-TOOL

- ROUTERS / PLANERS

- NAILERS / STAPLERS

- HEAT GUN / LASER

- CLEANING

- OPE

- JOBSITE TOOLS

- SPECIALTY TOOLS

- HAND TOOLS / COMBINATION SET

- TOOL HOLDERS AND POUCHES / MAKPAC SYSTEM

4300BV
AC

**Jig Saw**



**Long-run best seller, this tool puts performance first**

- Bevel cuts up to 45 degrees right or left
- Full 26mm (1") stroke length
- Variable speed feature



<b>Continuous rating Input</b>	390W
<b>Capacity</b>	In wood at 0 degrees : 55mm (2-1/8") In steel at 90 degrees : 6mm (1/4")
<b>Length of stroke</b>	26mm (1")
<b>Strokes per min.</b>	0-3,100
<b>Overall length</b>	225mm (8-7/8")
<b>Net weight</b>	2.5kg (5.5lbs)
<b>Power supply cord</b>	2.5m (8.2ft)

**Standard Equipment:** Rip Fence (Guide Rule), Circular Guide Assembly, Blade Clamp Assembly, Hex Wrench

- SAWING

- ROUTERS / PLANERS

- NAILERS / STAPLERS

- HEAT GUN / LASER

- CLEANING

- OPE

- JOBSITE TOOLS

- SPECIALTY TOOLS

- HAND TOOLS / COMBINATION SET

- TOOL HOLDERS AND POUCHES / MAKPAC SYSTEM

4326
AC

**Jig Saw**



**Light duty model with continuous input 450W**

- Ergonomically designed handle with rubberized grip provides more control and comfort
- Thick blade (1.7mm thickness) can also be used
- Dust Cover prevents scattering of tips
- Bevel cut 0 to 45 degrees left or right
- Quiet and less vibration

**Specifications:-** 

<b>Continuous rating Input</b>	450W
<b>Capacity</b>	In wood at 0 degrees : 65mm (2-9/16") In steel at 90 degrees : 6mm (1/4")
<b>Length of stroke</b>	18mm (11/16")
<b>Strokes per minute (spm)</b>	3,100
<b>Dimensions (L x W x H)</b>	224 x 77 x 197mm (8-7/8" x 3" x 7-3/4")
<b>Net weight</b>	1.8kg (4.0lbs)
<b>Power supply cord</b>	2.0m (6.6ft)

**Standard Equipment:** Hex Wrench

4327
AC

**Jig Saw**



**Light duty model with continuous input 450W**

- Ergonomically designed handle with rubberized grip provides more control and comfort
- Thick blade (1.7mm thickness) can also be used
- Dust Cover prevents scattering of tips
- Bevel cut 0 to 45 degrees left or right
- Quiet and less vibration
- Variable speed feature

**Specifications:-** 

<b>Continuous rating Input</b>	450W
<b>Capacity</b>	In wood at 0 degrees : 65mm (2-9/16") In steel at 90 degrees : 6mm (1/4")
<b>Length of stroke</b>	18mm (11/16")
<b>Strokes per minute (spm)</b>	500 - 3,100
<b>Dimensions (L x W x H)</b>	224 x 77 x 197mm (8-7/8" x 3" x 7-3/4")
<b>Net weight</b>	1.8kg (4.0lbs)
<b>Power supply cord</b>	2.0m (6.6ft)

**Standard Equipment:** Hex Wrench



4329



Jig Saw



Light duty model with continuous input 450W

- 3 orbital settings plus straight cutting
- Variable speed control dial (500-3,100 SPM) enables user to match the speed to the application for optimal cutting performance in a variety of materials.
- Through-the-body dust port provides optimal dust management with use of clear dust cover and vacuum.
- Bevel cuts to 45° right or left and positive stop at 90° for solid cutting performance



<b>Continuous rating Input</b>	450W
<b>Capacity</b>	In wood at 0 degrees : 65mm (2-9/16") In steel at 90 degrees : 6mm (1/4")
<b>Length of stroke</b>	18mm (11/16")
<b>Strokes per minute (spm)</b>	500 - 3,100
<b>Dimensions (L x W x H)</b>	224 x 77 x 197mm (8-7/8" x 3" x 7-3/4")
<b>Net weight</b>	1.8kg (4.0lbs)
<b>Power supply cord</b>	2.0m (6.6ft)

Standard Equipment: Hex Wrench

4350CT



Jig Saw



Tool less blade change system (with electronic control + speed dial)

- Electronic speed control maintains consistent speed set for various work piece
- 3 orbital settings plus straight cut
- Plastic cover plate can be attached without tool
- Low vibration and low noise level



<b>Continuous rating Input</b>	720W
<b>Capacity</b>	In wood at 90 degrees : 135mm (5-5/16") In steel at 90 degrees : 10mm (3/8")
<b>Length of stroke</b>	26mm (1")
<b>Strokes per minute</b>	800 - 2,800 spm
<b>Dimensions (L x W x H)</b>	236 x 73 x 207mm (9-1/4" x 2-7/8" x 8-1/8")
<b>Net weight</b>	2.4kg (5.3lbs)
<b>Power supply cord</b>	2.5m (8.2ft)

Standard Equipment: Hex Wrench, Cover Plate, Anti-Splintering Device

4350FCT



Jig Saw



Tool less blade change system (with electronic control + speed dial)

- Electronic speed control maintains consistent speed set for various work piece
- 3 orbital settings plus straight cut
- Plastic cover plate can be attached without tool
- Low vibration and low noise level
- Built-in LED job light for easy tracing of cutting line



<b>Continuous rating Input</b>	720W
<b>Capacity</b>	In wood at 90 degrees : 135mm (5-5/16") In steel at 90 degrees : 10mm (3/8")
<b>Length of stroke</b>	26mm (1")
<b>Strokes per minute</b>	800 - 2,800 spm
<b>Dimensions (L x W x H)</b>	236 x 73 x 207mm (9-1/4" x 2-7/8" x 8-1/8")
<b>Net weight</b>	2.4kg (5.3lbs)
<b>Power supply cord</b>	2.5m (8.2ft)

Standard Equipment: Hex Wrench, Cover Plate, Anti-Splintering Device

4351FCT



Jig Saw



Toolless blade change system (with electronic control + speed dial)

- Electronic speed control maintains consistent speed set for various work piece
- 3 orbital settings plus straight cut
- Built-in LED job light for easy tracing of cutting line.
- Ergonomically designed handle with soft grip provides more control and comfort.
- Low vibration and low noise level



<b>Continuous rating input</b>	720W
<b>Capacity</b>	Wood : 135mm (5-5/16") Steel : 10mm (3/8")
<b>Length of stroke</b>	26mm (1")
<b>Strokes per minute (spm)</b>	800 - 2,800
<b>Dimensions (L x W x H)</b>	271x73x187mm (10-11/16" x 2-7/8" x 7-3/8")
<b>Net weight</b>	2.5kg (5.5lbs)
<b>Power supply cord</b>	2.5m (8.2ft)

Standard Equipment: Hex wrench, Cover plate, Anti-splintering device

DRILLING / FIXING

CONCRETE DRILLING / DEMOLITION

MIXING / STIRRING

CUTTING (CONCRETE / METAL)

GRINDING

SANDING / POLISHING

SAWING

MULTI-TOOL

ROUTERS / PLANERS

NAILERS / STAPLERS

HEAT GUN / LASER

CLEANING

OPE

JOBSITE TOOLS

SPECIALTY TOOLS

HAND TOOLS / COMBINATION SET

TOOL HOLDERS AND POUCHES / MAKPAC SYSTEM

- DRILLING / FIXING
- CONCRETE DRILLING / DEMOLITION
- MIXING / STIRRING
- CUTTING (CONCRETE / METAL)
- GRINDING
- SANDING / POLISHING
- SAWING**
- MULTI-TOOL
- ROUTERS / PLANERS
- NAILERS / STAPLERS
- HEAT GUN / LASER
- CLEANING
- OPE
- JOBSITE TOOLS
- SPECIALTY TOOLS
- HAND TOOLS / COMBINATION SET
- TOOL HOLDERS AND POUCHES / MAKPAC SYSTEM



## Reciprocating Saw

JR002G

40V MAX | XGT

### Cordless Reciprocating Saw



#### Achieves high operation efficiency similar or superior to AC models

- Horizontal crank type system
- Counterweight mechanism drastically reduces vibration under loaded.
- Extra-Low Vibration achieved with AVT technology
- Orbital mechanism for high speed wood cutting
- Anti-drop mechanism for shoe minimizes drop of shoe
- Shoe can be removed simply by operating a lever and a button.
- Tool-less shoe adjustment
- Variable speed control by dial enables user to adjust the max cutting strokes



Length of Stroke	32 mm
Strokes Per Minute (SPM)	0 - 3,000
Capacity	Pipe / Wood: 130 / 255 mm
Dimensions (L x W x H)	424 x 97 x 217 mm
Net weight	3.9kg (without battery)

#### AVAILABLE VARIANTS

4.0Ah	"Z" VARIANT
<b>JR002G M2</b> INCLUDES 2 BATTERIES / 1 CHARGER / PLASTIC CASE	<b>JR002G Z</b> TOOL ONLY (DOES NOT INCLUDE BATTERY / CHARGER / CARRYING CASE)

JR001G

40V MAX | XGT

### Cordless Reciprocating Saw



#### Lightweight, Powerful, Durable and Built to perform

- Smooth cutting with vertical crank system
- Rubber joint structure
- Blade ejection lever is located on the housing side for increased operability



Length of Stroke	32 mm
Strokes Per Minute (SPM)	High / Low: 0 - 3,000 / 0 - 2,300
Capacity	Pipe : 130 mm / Wood: 255 mm
Dimensions (L x W x H)	472x88x239 mm (with 4.0Ah battery)
Net weight	3.5kg (without battery)

#### AVAILABLE VARIANTS

4.0Ah	"Z" VARIANT
<b>JR001G M2</b> INCLUDES 2 BATTERIES / 1 CHARGER / PLASTIC CASE	<b>JR001G Z</b> TOOL ONLY (DOES NOT INCLUDE BATTERY / CHARGER / CARRYING CASE)

DJR360

18Vx2 LXT

### Cordless Reciprocating Saw



#### Higher durability thanks to more durable mechanism to hold slider & more rigid shoe

- Our most powerful cordless reciprocating saw yet: Amazing work amount & efficiency
- Higher cutting speed and modified stroke length provide higher cutting efficiency.
- Newly designed vertical crank mechanism minimizes blade deflection and reduces vibration to machine.
- Two 18V LXT Li-Ion batteries deliver the power and run time for corded demands.



Capacity	Pipe : 130mm Wood : 255mm
Length of stroke	32mm
Strokes per minute (spm)	Hi : 0-3,000 Lo : 0-2,300
Dimensions (L x W x H)	448x115x242mm
Net weight	4.0kg

#### AVAILABLE VARIANTS

"Z" VARIANT
<b>DJR360 Z</b> TOOL ONLY (WITH CARRY CASE) (DOES NOT INCLUDE BATTERY / CHARGER)

**DJR187** 18V | **LXT**

**Cordless Reciprocating Saw**



**High efficiency and More work amount by Brushless DC motor**

- Newly designed vertical crank mechanism
  - i) Minimizes blade deflection from aiming point especially in metal cutting
  - ii) Reduces vibration of horizontal direction
- Electric 2 speed for wood / metal cutting
- Easy handling by redesigned blade clamp
- Ergonomically designed handle for better operation in every applications

**Capacity** Pipe : 130mm  
Wood : 255mm

**Length of stroke** 32mm

**Strokes per minute (spm)** Hi : 0-3,000 / Lo : 0-2,300

**Dimensions (L x W x H)** 439x83x230mm

**Net weight** 3.0kg (without battery)

**AVAILABLE VARIANTS**

5.0Ah	"Z" VARIANT
<b>DJR187 RTE</b> INCLUDES 2 BATTERIES / 1 CHARGER / PLASTIC CARRYING CASE	<b>DJR187 Z</b> TOOL ONLY (DOES NOT INCLUDE BATTERY / CHARGER OR CARRY CASE)

**DJR185** 18V | **LXT**

**Cordless Reciprocating Saw**



**Two switch levers are available with variable speed control.**

- Compact and lightweight handy body.
- Blade clamp compatible with both Recipro and Jig saw blades.
- LED job light with pre-glow function.

**Capacity** Pipe : 50mm  
Wood : 50mm

**Length of stroke** 13mm

**Strokes per minute (spm)** 0-3,000

**Dimensions (L x W x H)** 392x81x209mm (15-1/2"x3-3/16"x8-1/4")

**Net weight** 1.6kg

**Standard Equipment:** Hex wrench

**AVAILABLE VARIANTS**

"Z" VARIANT
<b>DJR185 Z</b> TOOL ONLY (DOES NOT INCLUDE BATTERY / CHARGER OR CARRY CASE)

**DJR189** 18V | **LXT**

**Cordless Reciprocating Saw**



**Powerful machine in Lightweight / compact design**

- Loop shaped handle to enhance housing rigidity and improve cutting efficiency.
- The handle can be gripped one handed and is positioned to allow firm transmission of force to the workpiece.
- A counterweight mechanism designed to reduce tool vibration and lower operator fatigue.

**Capacity** Pipe : 130 mm  
Wood : 255 mm

**Length of stroke** 22mm

**Strokes per minute (SPM)** 0 - 3,100

**Dimensions (L x W x H)** 366 x 81 x 154mm

**Net weight** 1.8 kg (without battery)

**AVAILABLE VARIANTS**

5.0Ah	"Z" VARIANT
<b>DJR189 RTJ</b> INCLUDES 2 BATTERIES / 1 CHARGER / MAKPAC CASE	<b>DJR189 Z</b> TOOL ONLY (DOES NOT INCLUDE BATTERY / CHARGER OR CARRY CASE)

**JR105D** 12V MAX | **CXT**

**Cordless Reciprocating Saw**



**Two switches (Trigger switch and Paddle switch) in different positions allow various grip positions for easier operation using either trigger.**

- Screw-down type blade clamp compatible with both Recipro saw / Jig saw blades
- Best possible ergonomic handle with soft grip fits your hand perfectly to provide maximum comfort and control.
- Battery protection circuit is activated on high battery temperature to protect the battery from damages due to over-discharge, high temperature or overload current.

**Capacity** Pipe : 50mm  
Wood : 50mm

**Length of stroke** 13mm

**Strokes per minute (spm)** 0-3,300

**Dimensions (L x W x H)** 376x66x186mm

**Net weight** 1.3kg

**Standard Equipment:** Hex wrench

**AVAILABLE VARIANTS**

2.0Ah	"Z" Version
<b>JR105D WAE</b> INCLUDES 2 BATTERIES / 1 CHARGER / CARRYING CASE	<b>JR105D Z</b> TOOL ONLY (DOES NOT INCLUDE BATTERY / CHARGER OR CARRY CASE)

- DRILLING / FIXING
- CONCRETE DRILLING / DEMOLITION
- MIXING / STIRRING
- CUTTING (CONCRETE / METAL)
- GRINDING
- SANDING / POLISHING
- SAWING
- MULTI-TOOL
- ROUTERS / PLANERS
- NAILERS / STAPLERS
- HEAT GUN / LASER
- CLEANING
- OPE
- JOBSITE TOOLS
- SPECIALTY TOOLS
- HAND TOOLS / COMBINATION SET
- TOOL HOLDERS AND POUCHES / MAKPAC SYSTEM

DRILLING / FIXING
CONCRETE DRILLING / DEMOLITION
MIXING / STIRRING
CUTTING (CONCRETE / METAL)
GRINDING
SANDING / POLISHING
SAWING
MULTI-TOOL

**JR3051T** -AC

**Recipro Saw, Orbital**



**High power, more compact and high durability**

- Delivers superior power and performance with less vibration
- Smooth Cutting in wood and metal applications
- Increased durability achieved by changing the slider holding mechanism
- Dust proof design 2 : Ring, and rubber seal protect gear housing against dust
- Tool-less blade change system
- Push the red button to adjust shoe positions



<b>Continuous rating input</b>	1,200W
<b>Capacity</b>	Pipe : 130 mm (3-1/2") Wood: 255 mm (10")
<b>Length of Stroke</b>	30 mm (1-3/16")
<b>Strokes Per Minute (SPM)</b>	0 - 3,000
<b>Dimensions (L x W x H)</b>	447x97x176 mm
<b>Net weight</b>	3.3 kg
<b>Power supply cord</b>	2.5 m

ROUTERS / PLANERS
-------------------

NAILERS / STAPLERS
--------------------

HEAT GUN / LASER
------------------

CLEANING
----------

OPE
-----

JOBSITE TOOLS
---------------

SPECIALTY TOOLS
-----------------

HAND TOOLS / COMBINATION SET
------------------------------

TOOL HOLDERS AND POUCHES / MAKPAC SYSTEM
--

**JR3061T** -AC

**Recipro Saw, Orbital**



**Vertical Crank Mechanism that minimizes blade deflection from the aiming point especially while cutting metal**

- Compact, light in weight and has a high cutting efficiency
- Highly durable machine that is achieved by changing the slider receiving mechanism
- Tool-less blade change and Tool-less shoe adjustment



<b>Continuous rating input</b>	1,250W
<b>Length of Stroke</b>	32 mm
<b>Strokes Per Minute (SPM)</b>	0 - 3,000
<b>Capacity</b>	Pipe : 130 mm Wood: 255 mm
<b>Vibration Level</b>	Cutting Boards: 18.5 m/s Cutting Wooden Beams: 16.5 m/s
<b>Sound Pressure Level</b>	88 dB(A)
<b>Sound Power Level</b>	99 dB(A)
<b>Dimensions (L x W x H)</b>	487x95x177 mm
<b>Net weight</b>	3.8 kg
<b>Power supply cord</b>	2.5 m

**SJ401** -AC

**Scroll Saw**



**Bevel cuts up to 45 degrees to the left and 15 degrees to the right**

- Tool-free blade change system
- Quick adjustment of blade tension thanks to blade tension lever
- Sturdy cast iron base for stability and less-vibration cutting



<b>Continuous rating Input</b>	50W
<b>Capacity</b>	Thickness of cut : 50mm (2") Throat : 406mm (16")
<b>Length of stroke</b>	18mm (11/16")
<b>Strokes per min.</b>	400-1,600 spm
<b>Overall length</b>	600mm (23-5/8")
<b>Net weight</b>	14.1kg (31lbs)

**Standard Equipment:** Saw Blades 6, Hex Wrench, Blade Change Rod

## Drywall Cutter & Cut-out Tool



## DC0181 18V | *LXT*

### Cordless Cut-Out Tool



**Higher performance & easier operation than corded tools**

- High power Cuts a layer of two drywalls. ( t=12.5mm )
- High power delivered by BL motor
- Compact, Lightweight and Less vibration
- Lightweight for reduced operator fatigue



**18V LITHIUM-ION MOTOR AWS XPT**

<b>Collet Capacity</b>	3 mm, 6 mm or 3.18 mm(1/8"), 6.35 mm(1/4")
<b>No Load Speed (RPM)</b>	32,000
<b>Circumference of Grip Portion</b>	210 mm (8-1/4")
<b>Vibration Level</b>	Rotation w/o Load: 2.5 m/s <sup>2</sup> or less
<b>Sound Pressure Level</b>	78 dB(A)
<b>Dimensions (L x W x H)</b>	311x79x117 mm
<b>Net weight</b>	1.7kg

**Standard Equipment:** Wrench

AVAILABLE VARIANTS

5.0Ah	"Z" VARIANT
<b>DC0181 RTJ</b> INCLUDES 2 BATTERIES / 1 CHARGER / MAKPAC CONNECTOR CASE	<b>DC0181 Z</b> TOOL ONLY (DOES NOT INCLUDE BATTERY / CHARGER OR CARRY CASE)

## DSD180 18V | *LXT*

### Cordless Drywall Cutter



**Suitable for straight cut in overhead application**

- Smooth and powerful cutting at the high rotational speed
- Cutting depth can be adjusted to drywall thickness.
- V-notch in base plate helps easy tracing of cutting line.
- Blade cover protects drywall surfaces from damage/ scratches.



**18V LITHIUM-ION MOTOR**

<b>Strokes Per Minute (SPM)</b>	0 - 6,000
<b>Length of Stroke</b>	6 mm
<b>Capacity</b>	Drywall: 30mm Wood: 15 mm
<b>Max Output</b>	340W
<b>Vibration Level</b>	Cutting Drywall (thickness 30mm): 2.5 m/s <sup>2</sup>
<b>Sound Pressure Level</b>	79 dB(A)
<b>Dimensions (L x W x H)</b>	263x79x291mm
<b>Net weight</b>	1.9kg

**Standard Equipment:** Base cover, Hex Wrench

AVAILABLE VARIANTS

**"Z" VARIANT**

**DSD180 Z**  
TOOL ONLY  
(DOES NOT INCLUDE BATTERY / CHARGER OR CARRY CASE)

## SD100D 12V MAX | *CXT*

### Cordless Drywall Cutter



**Excellent tool balance allows easy overhead application**

- Ideal for cutting holes in drywalls when setting ceiling lights, air vents etc.
- More suitable for straight cuts compared with general cut-out tools
- Dust box designed to catch dust in overhead applications for comfortable work



**12Vmax LITHIUM-ION MOTOR CXT**

<b>Strokes Per Minute (SPM)</b>	0 - 6,000
<b>Length of stroke</b>	6 mm (1/4")
<b>Capacity</b>	Drywall: 30 mm Wood: 15 mm
<b>Dimensions (L x W x H)</b>	239x79x266 mm
<b>Net weight</b>	1.6 kg

**Standard Equipment:** Base Cover, Hex Wrench

AVAILABLE VARIANTS

**"Z" Version**

**SD100D ZJ**  
TOOL WITH CARRYCASE (DOES NOT INCLUDE BATTERY / CHARGER)

- DRILLING / FIXING
- CONCRETE DRILLING / DEMOLITION
- MIXING / STIRRING
- CUTTING (CONCRETE / METAL)
- GRINDING
- SANDING / POLISHING
- SAWING
- MULTI-TOOL
- ROUTERS / PLANERS
- NAILERS / STAPLERS
- HEAT GUN / LASER
- CLEANING
- OPE
- JOBSITE TOOLS
- SPECIALTY TOOLS
- HAND TOOLS / COMBINATION SET
- TOOL HOLDERS AND POUCHES / MAKPAC SYSTEM

**Accessories**

		Suitable for Models	For Material	Part No
		DSD180, SD100D	Dry wall	B-49703
		DSD180, SD100D	Wood	B-49719

## Carbide-tipped saw blade Tooth shape

- DRILLING / FIXING
- CONCRETE DRILLING / DEMOLITION
- MIXING / STIRRING
- CUTTING (CONCRETE / METAL)
- GRINDING
- SANDING / POLISHING
- SAWING
- MULTI-TOOL
- ROUTERS / PLANERS
- NAILERS / STAPLERS
- HEAT GUN / LASER
- CLEANING
- OPE
- JOBSITE TOOLS
- SPECIALTY TOOLS
- HAND TOOLS / COMBINATION SET
- TOOL HOLDERS AND POUCHES / MAKPAC SYSTEM

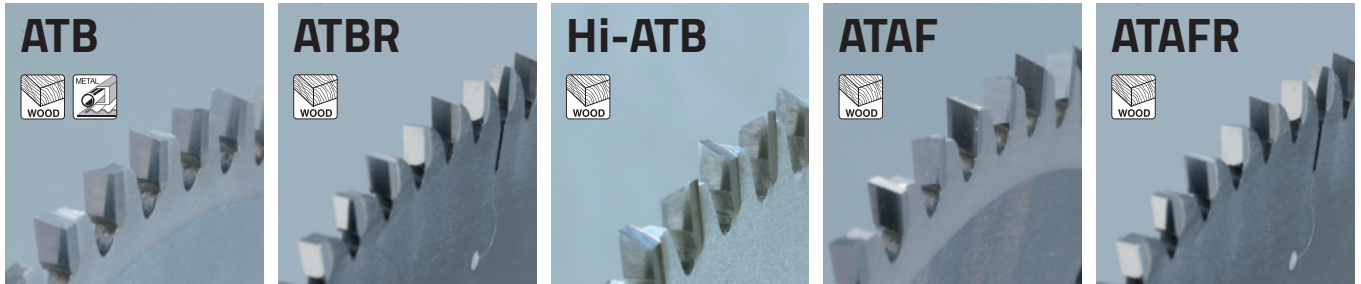

**ATB**  
Alternate top bevel  
For wood and aluminum.

**ATBR**  
Added flat teeth to ATB  
for easy straight cutting

**Hi-ATB**  
Alternate top bevel (ATB)  
with a larger top bevel angle

**ATAF**  
Alternate top alternate face  
Enables to cut wood fiber  
sharply.

**ATAFR**  
Added flat teeth to ATAF for easy  
straight cutting.  
MATAFR: Modified ATAFR for less  
cutting resistance.

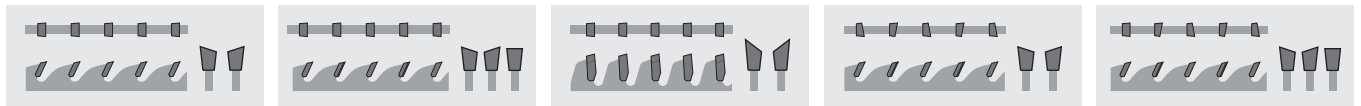

**M-FORCE**  
Tooth front and top shapes  
symmetric V groove having  
features of ATB and FTG.



**FTG**  
Flat teeth, allows easy  
straight cutting and tips are  
rarely chipped. For cutting  
wood along the grain and  
cutting thin metal.



**TCG**  
Trapezoidal and flat teeth are  
arranged alternatively and  
they divide debris by three.  
Allows easy straight cutting  
and tips are rarely chipped.



**MTCG**  
Flat teeth with alternating  
bevel Less cutting resistance  
than flat teeth. Tips are rarely  
chipped



**SMTCG**  
Contrast to MTCG, asymmet-  
ric two bevels on a tooth top  
producing sharp edges  
Allows easy bite to materials.

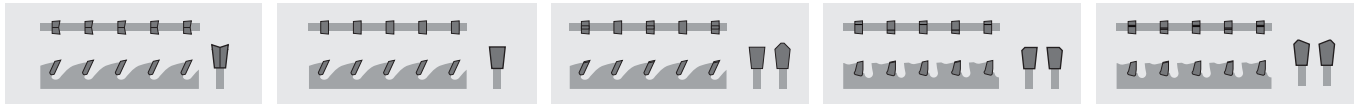

## Technical term

<p><b>Laser Slit</b></p>	<p><b>Coated</b></p>	<p><b>Tip Embedded</b></p>	<p><b>P.C.D Tip</b></p>
<p>Vibration dampening system Resinbond filled laser cut body slots for smoother and quieter cuts.</p>	<p>PTFE (polytetrafluoroethylene) coating plate to reduce pitch build-up and to lower resistance.</p>	<p>Inserted tooth design will greatly increase the body-to-tip braze area for greater support and tip strength.</p>	<p>PCD (Poly-Crystalline Diamond) tips has extreme hardness and wear resistance. PCD tipped saw blade is the best choice for long lasting performance when cutting fiber cement board.</p>



## Efficut saw blade for Circular Saw

Blade Dia (mm)	(Bore) Hole dia. (mm)	(Kerf) Tip Thickness (mm)	Plate (mm)	No. of teeth	Hook Angle (deg)	Tooth Shape	Application	Part No.
165	20	1.4	1	25	23	ATAFR	Wood	B-63018
165	20	1.45	1	56	23	ATAFR	Wood/MDF	B-57364
185	20	1.45	1	24	23	ATAFR	Wood	B-62022
185	20	1.45	1	45	23	ATAFR	Wood	B-68616
190	20	1.45	1	24	23	ATAFR	Wood	B-64200
190	20	1.45	1	45	23	ATAFR	Wood	B-68644
235	25	2.2	1.5	24	20	ATBR	Wood	E-01959
235	30	2.2	1.5	24	20	ATAFR	Wood	E-01909
260	25	2.15	1.5	24	23	ATAFR	Wood	E-07733
270	25.4	2.15	1.5	24	20	ATAFR	Wood	E-12974

## Efficut saw blade for Plunge Cut Circular Saw

Blade Dia (mm)	(Bore) Hole dia. (mm)	(Kerf) Tip Thickness (mm)	Plate (mm)	No. of teeth	Hook Angle (deg)	Tooth Shape	Application	Part No.
165	20	1.4	1	56	23	ATAFR	Wood / MDF	B-57364

## Efficut saw blade for Slide Compound Miter Saw

Blade Dia (mm)	(Bore) Hole dia. (mm)	(Kerf) Tip Thickness (mm)	Plate (mm)	No. of teeth	Hook Angle (deg)	Tooth Shape	Application	Part No.
165	20	1.85	1.35	60	10	ATAFR	Wood	B-69892
216	25.4	2	1.5	45	10	ATBR	Wood	E-07010
216	25.4	2	1.5	60	10	ATBR	Wood	E-08969
216	25.4	2	1.5	80	10	ATBR	Wood	E-08975
260	30	2.15	1.65	45	18	ATAFR	Wood	B-64624
260	30	2.15	1.65	60	10	ATAFR	Wood	B-67234
260	30	2.15	1.65	80	10	ATAFR	Wood	B-67240
305	30	2.15	1.65	60	10	ATAFR	Wood	B-67256
305	30	2.15	1.65	80	10	ATAFR	Wood	B-67262
305	30	2.15	1.65	100	10	ATAFR	Wood	B-67278



Blade Dia (mm)	(Bore) Hole dia. (mm)	(Kerf) Tip Thickness (mm)	Plate (mm)	No. of teeth	Hook Angle (deg)	Tooth Shape	Application	For models	Part No.
185	20	1.5	1	40	15	ATAFR	Composite deck	Circular saw	E-11972
260	30	2.15	1.7	75	8	ATAFR	Composite deck	Slide Compound Miter Saw	E-11988

DRILLING / FIXING

CONCRETE DRILLING / DEMOLITION

MIXING / STIRRING

CUTTING (CONCRETE / METAL)

GRINDING

SANDING / POLISHING

SAWING

MULTI-TOOL

ROUTERS / PLANERS

NAILERS / STAPLERS

HEAT GUN / LASER

CLEANING

OPE

JOBSITE TOOLS

SPECIALTY TOOLS

HAND TOOLS / COMBINATION SET

TOOL HOLDERS AND POUCHES / MAKPAC SYSTEM

DRILLING /  
FIXINGCONCRETE  
DRILLING /  
DEMOLITIONMIXING /  
STIRRINGCUTTING  
(CONCRETE /  
METAL)

GRINDING

SANDING /  
POLISHING

SAWING

MULTI-TOOL

ROUTERS /  
PLANERSNAILERS /  
STAPLERSHEAT GUN /  
LASER

CLEANING

OPE

JOBSITE  
TOOLSSPECIALTY  
TOOLSHAND TOOLS /  
COMBINATION SETTOOL HOLDERS  
AND POUCHES /  
MAKPAC SYSTEM

## Efficut saw blade for Steel Rod Cutter

Blade Dia (mm)	Suitable for Models	(Bore) Hole dia. (mm)	(Kerf) Tip Thickness (mm)	Plate (mm)	Hook Angle (deg)	No. of teeth	Tooth shape	Material	Part No.
110	DSC251	34	1.5	1.1	0	24	SMTCG	Metal	E-11097

## Efficut saw blade for Metal Cutter

Blade Dia (mm)	Suitable for Models	(Bore) Hole dia. (mm)	(Kerf) Tip Thickness (mm)	Plate (mm)	Hook Angle (deg)	No. of teeth	Tooth shape	Material	Part No.
150	DCS553	20	1.1	0.95	0	33	SMTCG	Metal	B-69440
150	DCS553	20	1.1	0.95	0	48	SMTCG	Metal & SUS	B-69456
185	CC002G	20	1.4	1.2	0	45	SMTCG	Metal	E-12918
185	CC002G	20	1.4	1.2	0	60	SMTCG	Metal & SUS	E-12924

## Efficut saw blade for Metal Cutting Saw

Blade Dia (mm)	Suitable for Models	(Bore) Hole dia. (mm)	(Kerf) Tip Thickness (mm)	Plate (mm)	Hook Angle (deg)	No. of teeth	Tooth shape	Material	Part No.
305	LC1230	25.4	2.0	1.75	-2	63	SMTCG	Metal	E-12083
305	LC1230	25.4	2.0	1.75	-3	96	SMTCG	Metal, SUS	E-19788



## Efficut saw blade for Circular / Compound Miter Saw - Aluminium

Blade Dia (mm)	(Bore) Hole dia. (mm)	Standard Ring	(Kerf) Tip Thickness (mm)	Plate (mm)	Hook Angle (deg)	No. of teeth	Tooth shape	Material	Used with	Part No.
165	20	-	1.5	1.15	-3	54	SMTCG	Aluminium	Circular Saw / Compound Miter Saw	E-16760
185	30	-	1.7	1.35	0	60	SMTCG	Aluminium	Circular Saw	E-16813
190	30	20mm ring	1.7	1.35	0	60	SMTCG	Aluminium	Circular Saw / Slide Compound Miter Saw	E-16863
216	30	-	1.85	1.5	0	63	SMTCG	Aluminium	Slide Compound Miter Saw	E-16916
305	25.4	-	2.0	1.65	-3	81	SMTCG	Aluminium	Slide Compound Miter Saw	E-13281
305	25.4	-	2.0	1.65	-3	96	SMTCG	Aluminium	Slide Compound Miter Saw	E-13340



## Plunge Cut Saw Blades

Blades Designed specifically for Plunge Type Saws. Available for cutting both wood and aluminium, they are especially designed for a smooth clean cut. Plunge saw blades comes with a patented technology dampening vibration. The low vibration blades run truer with less wobble easily plunging into material with little effort.



Blade Dia (mm)	Suitable for Models	(Bore) Hole dia. (mm)	Ring Size	(Kerf) Tip Thickness (mm)	Plate (mm)	Hook Angle (deg)	No. of teeth	Tooth Shape	Application	Part No.
165	SP001G, DSP600, DSP601, SP6000	20	-	1.85	1.25	8	48	ATB	Wood	B-56166
165	SP001G, DSP600, DSP601, SP6000	20	-	2.2	1.6	8	48	ATB	Wood	B-09298
165	SP001G, DSP600, DSP601, SP6000	20	-	2.0	1.4	5	60	TCG	MDF	B-56677
165	SP001G, DSP600, DSP601, SP6000	20	-	2.0	1.4	-3	56	TCG	Aluminum	B-56655
165	SP001G, DSP600, DSP601, SP6000	20	-	2.4	1.7	-3	56	TCG	Aluminum	B-09307
165	SP001G, DSP600, DSP601, SP6000	20	-	2.0	1.4	5	48	TCG	CORIAN®	B-56683

- DRILLING / FIXING
- CONCRETE DRILLING / DEMOLITION
- MIXING / STIRRING
- CUTTING (CONCRETE / METAL)
- GRINDING
- SANDING / POLISHING
- SAWING
- MULTI-TOOL
- ROUTERS / PLANERS
- NAILERS / STAPLERS

## Specialized Circular Saw Blade for Sandwich Panel

Application/ Recommended Use

- Suitable for cutting a sandwich panel
- Ideal for roofing contractors and insulated panel walls.

**TRIPLE CHIP GRIND**  
The modified Triple Chip Grind tooth design prevents premature chipping with harder tungsten for longer life

**ANTI-KICK BACK SHOULDER**  
Tooth design prevents lifting of the material between the metal panels causing kick back

**LASER SLOTS**  
Laser etched and back filled with bonding to reduce vibration and noise

Blade Dia (mm)	Suitable for Models	(Bore) Hole dia. (mm)	Ring Size	(Kerf) Tip Thickness (mm)	Plate (mm)	Hook Angle (deg)	No. of teeth	Tooth hape	Part No.
165	Circular Saws	20	-	1.75	1.4	0	42	SMTCG	B-63161

- HEAT GUN / LASER
- CLEANING
- OPE
- JOBSITE TOOLS
- SPECIALTY TOOLS
- HAND TOOLS / COMBINATION SET
- TOOL HOLDERS AND POUCHES / MAKPAC SYSTEM

## Circular Saw Blade (Standard Range)

Application/ Recommended Use

- Cross and rip cutting, Wood, Joinery, Carpentry & Cabinet making.



Blade Dia (mm)	Suitable for Models	(Bore) Hole dia. (mm)	Ring Size	(Kerf) Tip Thickness (mm)	Hook Angle (deg)	No. of teeth	Tooth hape	Application	Part No.
165	HS012G, DHS660, DHS661, DHS680	20	-	2.0	18	40	ATB	Wood	D-03349
185	HS004G, RS001G, DHS783, DRS780, HS7010, 5007N	30	16, 20	2.0	20	16	ATB	Wood	D-03903
185	HS004G, RS001G, DHS783, DRS780, HS7010, 5007N	30	16, 20	2.0	20	20	ATB	Wood	D-09634
185	HS004G, RS001G, DHS783, DRS780, HS7010, 5007N	30	16, 20	2.0	18	40	ATB	Wood	D-03919
195	HS004G, RS001G, DHS783, DRS780, HS7010, 5007N	25.4	-	2.0	10	80	ATB	Wood	D-16396
235	HS009G, DHS900, N5900B	30	25, 25.4	2.4	20	20	ATB	Wood	D-03925
235	HS009G, DHS900, N5900B	30	25	2.4	18	48	ATB	Wood	D-03931
235	HS009G, DHS900, N5900B	30	25	2.4	15	60	ATB	Wood	D-09640



## Table Saw Blade

Blade Dia (mm)	Suitable for Models	(Bore) Hole dia. (mm)	Ring Size	(Kerf) Tip Thickness (mm)	Hook Angle (deg)	No. of teeth	Tooth Shape	Part No.
210	2702 (Not suitable for 2703/2704)	30	25.4	1.9	25	18	ATB	Wood A-81767 (Tip Embedded)
255	2703, 2704	25.4	-	2.3	20	24	ATB	Wood B-05000
260	MLT100	30	-	1.8	15	40	-	Wood D-74077 (JM00000385)
315	2712	30	-	2.8	9	40	-	Wood JM27170005

## Thin Kerf Saw Blade

- Fast Cut / Fine Finish
- Thin kerf for less waste and reduced feed pressure.
- Application: Cross and rip cutting. Wood. Joinery, Carpentry & Cabinet making.

Blade Dia (mm)	Suitable for Models	(Bore) Hole dia. (mm)	Ring Size	(Kerf) Tip Thickness (mm)	Hook Angle (deg)	No. of teeth	Tooth Shape	Part No.
160	HS012G, DHS680, DHS660, DHS661, DHS680	20	-	1.6	18	40	ATAF	A-80612
185	HS004G, RS001G, DHS783, DRS780, HS7010, 5007N	20	-	1.6	18	40	-	A-80628

## Specialized Blade for Construction Embedded tip for wood with nails (For Construction)

- Can easily cut through wood embedded with nails and screws
- Extremely tough and hard wearing
- Extended service life and productivity



Blade Dia (mm)	Suitable for Models	(Bore) Hole dia. (mm)	(Kerf) Tip Thickness (mm)	Plate Thickness (mm)	Hook Angle (deg)	No. of teeth	Pcs/ Pkg	Part No.
235	HS009G, DHS900, N5900B	30	2.6	1.6	20	16	1	B-27274

## 'M' Force Blade (Advanced Tooth Design)

A revolutionary advanced tooth design that sets a new bench mark for blade technology. The dual bevelled tooth face has sharper cutting edges and the "M" shape is like doubling the tooth count per blade. A greater wear area and more cutting surfaces means the MForce blade will last up to 2 x longer than traditional blades. A narrow kerf and plate reduces friction allowing for a lighter feed pressure, protecting the motor of your saw.

- Superior cutting surface with less number of teeth.
- Ideal for straight cutting.
- Longer lasting.
- Tooth Type/Set: M Force Blades



**Cleaner**  
'M' shaped 24 tooth has 2 cutting tips that work like a 48 tooth blade!

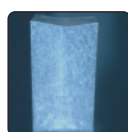

**Faster**  
Bevel tooth face creates sharper edges for an aggressive cut!



**Lasts longer**  
Greater wear area and more cutting tips increase the life of the blade by 2x!

### Application/ Recommended Use

Wood, Non Ferrous material, Plastics, Aluminum, Insulation material, etc.

Blade Dia (mm)	Suitable for Models	(Bore) Hole dia. (mm)	Ring Size	(Kerf) Tip Thickness (mm)	Hook Angle (deg)	No. of teeth	Tooth Shape	Part No.
185	HS004G, RS001G, DHS783, DRS780, HS7010, 5007N	30	16, 20	2.0	15	16	M-FORCE	A-89648
185		30	16, 20	2.0	15	24	M-FORCE	A-89654
235	HS009G, DHS900, N9500B	30	15.88 / 25	2.3	15	20	M-FORCE	B-04117
235		30	15.88 / 25	2.3	15	40	M-FORCE	B-04123

- DRILLING / FIXING
- CONCRETE DRILLING / DEMOLITION
- MIXING / STIRRING
- CUTTING (CONCRETE / METAL)
- GRINDING
- SANDING / POLISHING
- SAWING
- MULTI-TOOL
- ROUTERS / PLANERS
- NAILERS / STAPLERS
- HEAT GUN / LASER
- CLEANING
- OPE
- JOB SITE TOOLS
- SPECIALTY TOOLS
- HAND TOOLS / COMBINATION SET
- TOOL HOLDERS AND POUCHES / MAKPAC SYSTEM

## Specialized for Cutting (MDF) Medium Density Fiber board

- Specially suited for medium density fibre Boards (MDF) Type A: Suitable for Circular Saw Type B: Suitable for Slide Compound Saw / Miter Saw

Blade Dia (mm)	(Bore) Hole dia. (mm)	Ring Size	(Kerf) Tip Thickness (mm)	Hook Angle (deg)	No. of teeth	Tooth Shape	Type	Part No.
185	30	16, 20	2.4	12	60	TCG	A	D-17902
235	30	25	2.8	12	80	TCG	A	D-17918
254	30	15.88	3.2	10	100	TCG	B	D-19071
305	30	15.88	3.2	10	120	TCG	B	D-19087

## Specialized Saw Blades for Aluminium

Blade Dia (mm)	Suitable for Models	(Bore) Hole dia. (mm)	Ring Size	(Kerf) Tip Thickness (mm)	Hook Angle (deg)	No. of teeth	Tooth Shape	Part No.
260	LS004G, DLS111, LS1019L, LS1018L, LS1040, LH1040, LF1000, MLS100	30	15.88	2.3	-5	80	-	B-04151
260	LS004G, DLS111, LS1019L, LS1018L, LS1040, LH1040, LF1000, MLS100	30	15.88	2.3	-5	100	-	B-04167
305	LS003G, DLS211, LS1219L, LH1201FL	30	15.88	2.3	-5	100	-	B-04189
355	LS1440	30	25	3.0	-5	120	-	B-12522

## Universal Saw Blade for Cutting Wood and Metal

Blade Dia (mm)	Suitable for Models	(Bore) Hole dia. (mm)	Ring Size	(Kerf) Tip Thickness (mm)	Hook Angle (deg)	No. of teeth	Tooth Shape	Part No.
210	For Circular saw	30	25	2.8	-5	54	-	A-02646
255	DLS111, LS1019L, LS1018L, LS1040, LH1040, LF1000, MLS100	30	25	3.2	-5	80	TCG	A-02668

## Combination Saw Blade (H.S.S)

**Application/ Recommended Use:** For rip and cross-cut work. Has fewer teeth than cross cut blade for faster cutting.

Blade Dia (mm)	(Bore) Hole dia. (mm)	(Kerf) Tip Thickness (mm)	No. of Teeth	Part No.
110	20	0.9	50	792010-8
185	20	1.25	50	792495-8
255	25	1.45	52	792423-3
260	25	1.25	52	792083-1

## Cross Cut Saw Blade (H.S.S)

**Application/ Recommended Use:** For smoother cross-grain cuts in wood. Make smoother cuts than combination blade.

Type A: Miter saw blade for Wood

Blade Dia (mm)	(Bore) Hole dia. (mm)	(Kerf) Tip Thickness (mm)	No. of Teeth	Type	Part No.
110	20	-	60	-	792012-4
415	25	-	100	-	792115-4

## Ring

(for 5/8" = 15.88 mm spindle)

Outer Dia (mm)	(Bore) Hole dia. (mm)	(Kerf) Tip Thickness (mm)	Pcs / Pkg	Part No.
25	15.88	4.0	1	257022-3
25.4	15.88	4.0	1	257060-5
30	15.88	3.0	10	A-87270
30	25.4	-	1	■ B-21060
30	20	-	1	■ B-21026

## Other Specialized Blades For Metal Cutter

A: Cermet tip type (Ceramic / Metal), Long Life

Blade Dia (mm)	Suitable for Models	(Bore) Hole dia. (mm)	(Kerf) Tip Thickness (mm)	Hook Angle (deg)	No. of teeth	Tooth Shape	Material / Application	Type	Part No.
136	DCS550	20	1.5	0	30	MTCG	Mild steel (1 - 3mm)	-	B-07319
150	DCS553	20	1.5	0	32	MTCG	Mild steel (1 - 3mm)	-	B-46296
150	DCS553	20	1.1	0	60	SMTCG	Stainless/Mild steel (2 mm)	Laser Slit	B-47014
150	DCS553	20	1.1	0	32	TCG	Thick Steel (2 - 12mm)	Laser Slit	E-02923
185	4131	20	1.9	0	36	ATB	Mild steel (2 - 6mm)	A	B-04628
185	4131	20	2.0	0	48	MTCG	Thin mild steel (2 - 4mm)	-	A-83967
185	4131	20	1.7	-10	70	FTG	Corrugated thin plate (Less than 2mm)	-	A-86446

## For Portable Cut-Off

Blade Dia (mm)	Suitable for Models	(Bore) Hole dia. (mm)	(Kerf) Tip Thickness (mm)	Hook Angle (deg)	No. of teeth	Tooth Shape	Material / Application	Type	Part No.
305	LC1230	25.4	2.4	0	60	TCG	For cutting mild steel	Laser slit	A-86723
305	LC1230	25.4	2.4	0	78	MTCG	For thinner mild steel	-	A-87127
305	LC1230	25.4	2.3	0	76	-	For stainless steel	-	A-87579
305	LC1230	25.4	2.1	0	60	TCG	For mild steel	-	A-87242

## For for 4100NH Cutter

Model 4100NH is a powerful cutter machine for cutting in stone, masonry, tile, concrete.

Now Makita developed new T.C.T wood cutting saw blade for cutter 4100NH which make this machine more versatile.



**SPECIALIZED**  
for wood cutting



4100NH

Blade Dia (mm)	Suitable for Models	(Bore) Hole dia. (mm)	(Kerf) Tip Thickness (mm)	Plate Thickness (mm)	No. of teeth	Tooth Shape	Part No.
100	4100NH	20	1.6	1.0	30	-	B-39475

## Saw Blade Depth Adjustment

Saw blade depth adjustment is critical for good performance and operator safety. i.e reduce the risk of limb injury while holding the work piece for example. The lower the angle the smoother & faster the cut

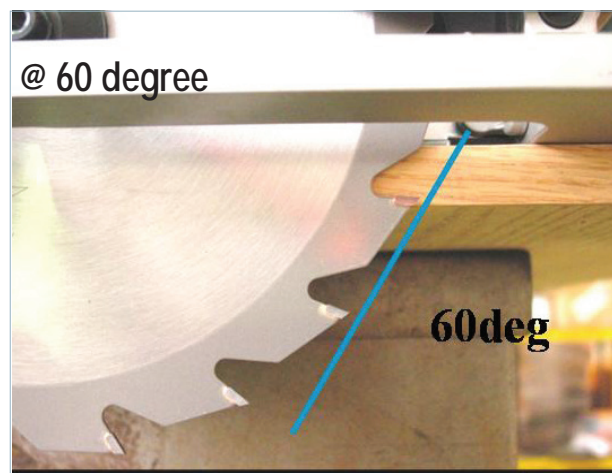
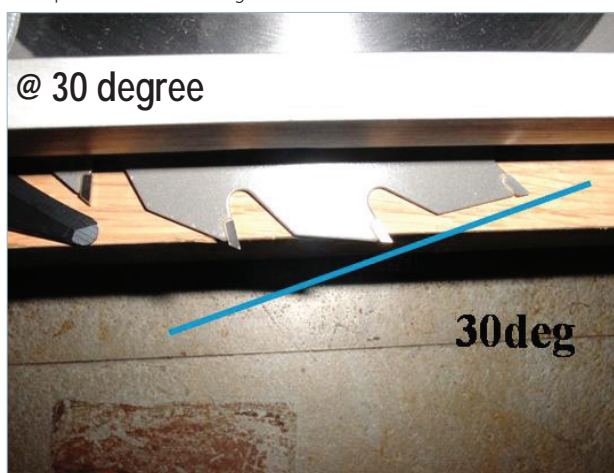

Two cutting tips are engaged in a "shaving" position allowing the tooth to cut at a 30 degree angle

Only one cutting tip is engaged in a "chopping" position forcing the tooth to cut at a 60 degree angle.

- DRILLING / FIXING
- CONCRETE DRILLING / DEMOLITION
- MIXING / STIRRING
- CUTTING (CONCRETE / METAL)
- GRINDING
- SANDING / POLISHING
- SAWING
- MULTI-TOOL
- ROUTERS / PLANERS
- NAILERS / STAPLERS
- HEAT GUN / LASER
- CLEANING
- OPE
- JOB SITE TOOLS
- SPECIALTY TOOLS
- HAND TOOLS / COMBINATION SET
- TOOL HOLDERS AND POUCHES / MAKPAC SYSTEM

- DRILLING / FIXING
- CONCRETE DRILLING / DEMOLITION
- MIXING / STIRRING
- CUTTING (CONCRETE / METAL)
- GRINDING
- SANDING / POLISHING
- SAWING**
- MULTI-TOOL
- ROUTERS / PLANERS
- NAILERS / STAPLERS
- HEAT GUN / LASER
- CLEANING
- OPE
- JOBSITE TOOLS
- SPECIALTY TOOLS
- HAND TOOLS / COMBINATION SET
- TOOL HOLDERS AND POUCHES / MAKPAC SYSTEM

## Jig Saw Blade Teeth Type

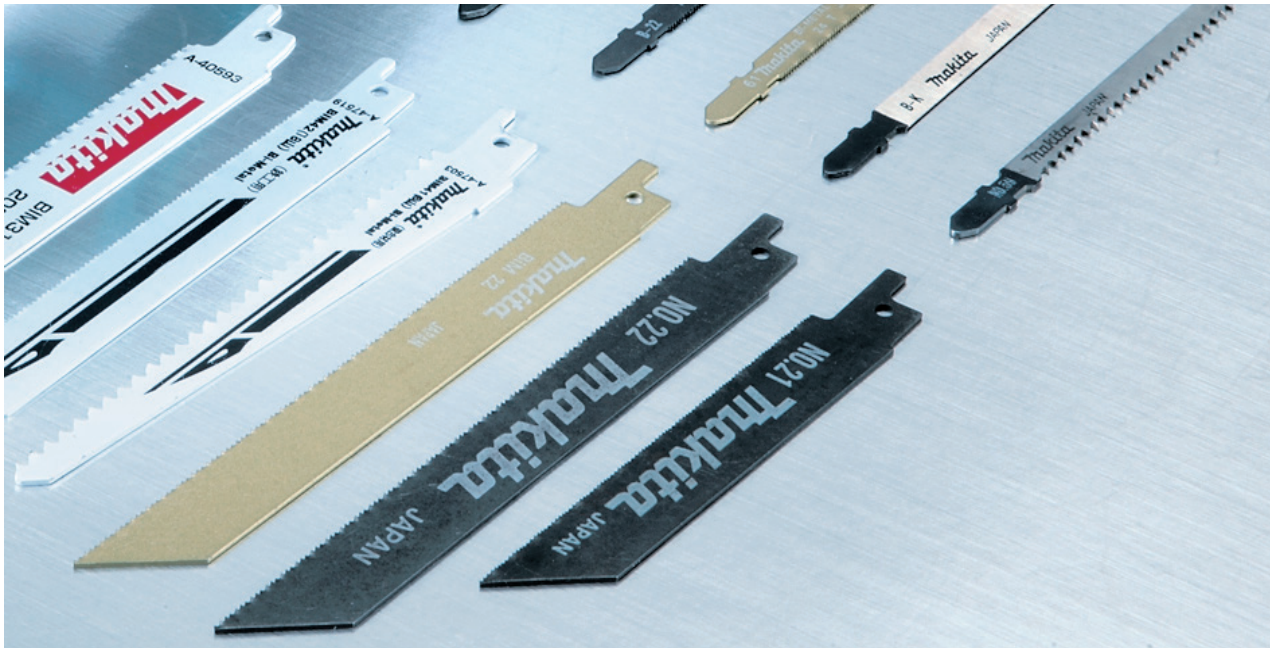
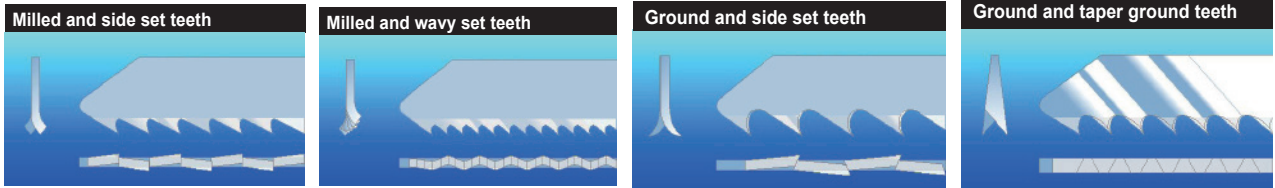

### Teeth manufacture



#### Milled teeth

- Low cost type of manufacturing
- For general cutting
- Soft to hard materials
- Long blade life

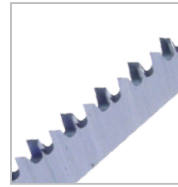

#### Ground teeth

- Costly type of manufacturing
- Very sharp
- Accurate, clean cut
- Soft to medium hard materials

### Production method

**Side set:** Each individual tooth is alternately bend to the left and to the right. Raker setting example: right, left, straight, etc.



**Wavy set:** Row of teeth receives a wave shape

**Ground:** Blade body tapers to the rear (conical)

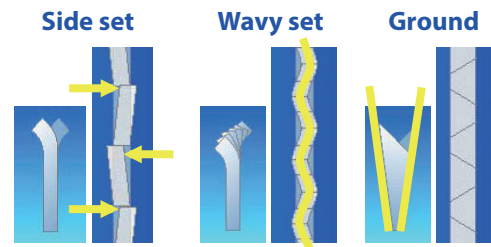

### Jig Saw Blade material

Most of our jigsaw blades are manufactured using top quality Japanese steel and are available to cover a very broad spectrum of applications in wood and metal.





- **HCS (High Carbon Steel):** For cutting softer materials such as wood or plastics.
- **HSS (High Speed Steel):** For cutting harder materials such as metals.
- **BiM (Bi-metal, HCS base and HSS teeth):** For cutting soft materials to hard materials such as wood, metal, plastics.
- **TC (Tungsten Carbide):** For cutting glass fiber reinforced plastic, cement-bonded fiberboards or plasterboard.

## Makita Type Jig Saw Blade for Wood



For Model: 4300BA/BV, 4326M, 4327M

Shape	No	Wood Plywood (mm)	Plastics (mm)	Aluminum (mm)	Stainless Steel (mm)	Mild Steel (mm)	Features / Application	Working Length (mm)	Tooth Per Inch	Material	Type of cutting	Per pkg.	Part No.
-------	----	-------------------	---------------	---------------	----------------------	-----------------	------------------------	---------------------	----------------	----------	-----------------	----------	----------





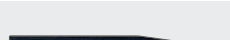



### WOOD / BASIC

	3	3-50	3-50				For general cutting of wood & plastics	60	9	HCS		5	A-85868
	16	3-50	3-50				For scroll cutting of wood & plastics	60	9	HCS		5	A-85830



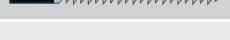



### WOOD / FAST

	8	4-50	4-50				For fast cutting of wood & plastics	60	8	HCS		5	A-85911
---	---	------	------	--	--	--	-------------------------------------	----	---	-----	---	---	---------

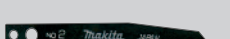

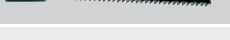

### WOOD / FINISH

	9	4-50	4-50				For fast finish work in wood & plastics	60	9	HCS		5	A-85927
	10	4-50	4-50				For fast finish work especially in plywood	60	9	HCS		5	A-85818
	10S	3-50					Splinter-free cuts in wood requiring no sanding	62	13	HCS		5	A-85824
	BR-3	4-50					Splinter-free cuts in wood requiring no sanding	60	9	HCS		5	A-85933

### HARDWOOD / DECORATIVE VENEERS

	2	3-50	3-50	2-6		2-6	For decorative veneers	60	14	HSS		5	A-85852
	4	3-50	3-50	3-6		3-6	For hardwood, thick mild steel plate and tough plastic	62	9	HSS		5	A-85874
	17	2-50	2-50	2-6		2-6	Ideal for scroll cutting of decorative veneers	63	14	HSS		5	A-85846

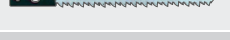



### FINISH FOR DECORATIVE VENEERS

	41	3-50	3-50				For tough plastics & decorative veneers finishing (Splinter-free downward cutting teeth)	60	12	HSS		5	A-85880
	42	2-50	2-50				For decorative veneers	60	16	HSS		5	A-85896

## Makita Type Jig Saw Blade for Metal

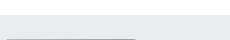
For Model: 4300BA/BV, 4326M, 4327M

### METAL / BASIC

	1		1-6	1-3	0.5-3	1-3	For mild steel, stainless steel. Also for corrugated & tough plastics.	60	24	HSS		5	A-85802
	5		2-50				For mild steel	42	24	HSS		5	A-85905

DRILLING / FIXING

CONCRETE DRILLING / DEMOLITION

MIXING / STIRRING

CUTTING (CONCRETE / METAL)

GRINDING

SANDING / POLISHING

SAWING

MULTI-TOOL

ROUTERS / PLANERS

NAILERS / STAPLERS

HEAT GUN / LASER

CLEANING

OPE

JOB SITE TOOLS

SPECIALTY TOOLS

HAND TOOLS / COMBINATION SET









TOOL HOLDERS AND POUCHES / MAKPAC SYSTEM

## B Type Jig Saw Blade (Universal Blade) for Wood



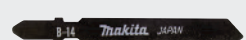







- Fits Makita and most common Jig Saws.
- For Model: JV001G DJV180, JV100D, JV101D, JV102D, JV103D, JV183D, DJR185, JR105D, 4326, 4327, 4329, 4350CT/FCT, 4351FCT, JR1000FT

Shape	No	Wood Plywood (mm)	Plastics (mm)	Aluminum (mm)	Stainless Steel (mm)	Mild Steel (mm)	Features / Application	Working Length (mm)	Tooth Per Inch	Material	Type of cutting Per Pkg.	Part No.
-------	----	-------------------	---------------	---------------	----------------------	-----------------	------------------------	---------------------	----------------	----------	--------------------------	----------

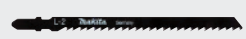















### WOOD / BASIC

	B-13	4-65	4-65				For general cutting of wood & plastic	70	8	HCS		5	A-85656
	B-15	3-35	3-35				Ideal for cutting thin materials	50	12	HCS		5	A-85678
	B-14	2-35	2-35				Ideal for cutting thin materials	50	18	HCS		5	A-85662
	B-18	2-35	2-35				Ideal for scroll cutting of wood & plastic	45	14	HCS		5	A-85709



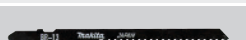

### WOOD / FAST

	B-13	4-65	4-65				For fast cutting of wood & plastic	70	8	HCS		5	A-86577
	B-16	5-65	5-65				For fast cutting of wood & plastic	50	6	HCS		5	A-85684
	L-2	5-90	5-90				Ideal for fast cutting of thick materials	100	6	HCS		5	A-86309
	B-17	5-60	5-60				Ideal for scroll cutting of wood & plastic (Fast cutting)	70	6	HCS		5	A-85690
	B-8	4-65	4-65				Ideal for fast cutting of wood & plastic. Hook angle 2°	75	8	HCS		5	A-85232



### WOOD / FINISH

	B-9	4-65	4-65				For fast finish work in wood & plastic	75	8	HCS		5	A-86583
	B-10	3-65	3-65				For fast finish work especially in plywood	75	9	HCS		5	A-85628
	B-11	3-60	3-60				For fast finish work in wood & plastic	75	9	HCS		5	A-85634
	B-10S	3-50					Splinter-free cuts in wood requiring no sanding	65	13	HCS		5	792691-8
	B-12	5-65	5-65				For fast finish work in wood & plastic	75	6	HCS		5	A-85640
	L-1	5-90	5-90				For fast finish work in wood & plastic	100	6	HCS		5	A-86290
	B-29	2-35	2-35				Ideal for scroll cutting of wood & plastic (Finishing)	42	16	HCS		5	A-80400
	BR-13	5-65					Splinter-free cuts in wood requiring no sanding.	64	9	HCS		5	A-85793

### HARDWOOD / DECORATIVE VENEERS

	B-25	3-60	3-6		3-6		For hardwood, thick mild steel plate & tough plastic	75	9	HSS		5	A-85765
	B-26	3-60	3-10		3-10		For scroll cutting in hard woods & in tough plastic	70	9	HSS		5	A-85771

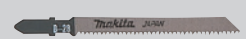
### FINISH FOR DECORATIVE VENEERS

	B-19	3-50	3-50				For tough plastic & decorative veneer finishing. (Splinter free downward cutting teeth)	65	12	HCS		5	A-85715
	B-28	2-50	2-50				For decorative veneers	63	16	HSS		5	A-80391

DRILLING /  
FIXINGCONCRETE  
DRILLING /  
DEMOLITIONMIXING /  
STIRRINGCUTTING  
(CONCRETE /  
METAL)

GRINDING

SANDING /  
POLISHING

SAWING

MULTI-TOOL

ROUTERS /  
PLANERSNAILERS /  
STAPLERSHEAT GUN /  
LASER

CLEANING



OPE

JOBSITE  
TOOLSSPECIALTY  
TOOLSHAND TOOLS /  
COMBINATION SETTOOL HOLDERS  
AND POUCHES /  
MAKPAC SYSTEM











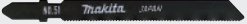

## B Type Jig Saw Blade for Stainless Steel





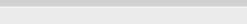



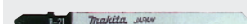

- Specially designed and hardened with TC metal for cutting stainless steel.
- Longer life than standard jigsaw blades • Capable of making a 3m cut in 1.5mm of stainless steel.

Shape	No	Wood Plywood (mm)	Plastics (mm)	Aluminium (mm)	Stainless Steel (mm)	Mild Steel (mm)	Features / Application	Working Length (mm)	Tooth Per Inch	Material	Type of cutting	Per pkg.	Part No.
					1-2, 5	1-5	For Stainless Steel	50	12	HM		1	P-05929

## B Type Jig Saw Blade for Metal

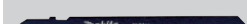
Shape	No	Wood Plywood (mm)	Plastics (mm)	Aluminium (mm)	Stainless Steel (mm)	Mild Steel (mm)	Features / Application	Working Length (mm)	Tooth Per Inch	Material	Type of cutting	Per pkg.	Part No.
	51	1.5-6	1.5-6	1-3	1-3		For mild steel	65	24	HSS		5	A-86561
	B-22	1-6	1-3	1-3	1-3		For mild steel, stainless steel. Also for tough plastics	50	24	HSS		5	A-85737
	B-24		1-3	1-2	0.5-2	0.5-2	For thin mild steel, stainless steel	50	32	HSS		5	A-85759
	B-23	3-35	3-35	2-6		2-6	For decorative veneers	50	14	HSS		5	A-85743
	B-27	1-6	1-3	1-3	1-3		For scroll cutting in mild steel	50	24	HSS		5	A-85787

## B Type Jig Saw Blade Universal Fitting (Specialized)

Shape	No	Wood Plywood (mm)	Plastics (mm)	Aluminium (mm)	Stainless Steel (mm)	Mild Steel (mm)	Features / Application	Working Length (mm)	Tooth Per Inch	Material	Type of cutting	Per pkg.	Part No.
<b>PLASTIC</b>													
	B-21	3-60	1-10				For plastics finish work and tough plastics and aluminium	75	12	HSS		5	A-85721
<b>RUBBER</b>													
	B-K						Ideal for cutting of paper, cork, rubber and leather	75		HCS		5	A-80416
<b>THICK MATERIAL</b>													
	L-10	5-135	5-135				Ideal for cutting thick materials.	150	6	HCS		5	A-86315
<b>FIBER GLASS</b>													
		6-80					Ideal for cutting fiberglass, reinforced plastic etc.	75	6	HM		3	P-38766
		6-80					Ideal for cutting fiberglass, reinforced plastic etc.	105	6	HM		3	P-38772

- DRILLING / FIXING
- CONCRETE DRILLING / DEMOLITION
- MIXING / STIRRING
- CUTTING (CONCRETE / METAL)
- GRINDING
- SANDING / POLISHING
- SAWING
- MULTI-TOOL
- ROUTERS / PLANERS
- NAILERS / STAPLERS
- HEAT GUN / LASER
- CLEANING
- OPE
- JBSITE TOOLS
- SPECIALTY TOOLS
- HAND TOOLS / COMBINATION SET
- TOOL HOLDERS AND POUCHES / MAKPAC SYSTEM

DRILLING / FIXING

CONCRETE DRILLING / DEMOLITION







MIXING / STIRRING

CUTTING (CONCRETE / METAL)

## B Type Jig Saw Blade Universal Fitting - Super Express

These blades are a 'Bayonet fit', and can be used with most models of jigsaws.

- For Model: DJV180, JV100D, JV101D, JV102D, JV103D, JV183D, DJR185, JR105D, 4326, 4327, 4329, 4350CT/FCT, 4351FCT, JR1000FT

Shape	No	Wood Plywood (mm)	Plastics (mm)	Aluminium (mm)	Stainless Steel (mm)	Mild Steel (mm)	Features / Application	Working Length (mm)	Tooth Per Inch	Material	Type of cutting	Per pkg.	Part No.
	B-50	5-50	5-50	-	-	-	For a quick cut in wood, with a fine finish	77	8.5-10.6	HCS		5	B-06460
	B-51				1-3	1-8	For metal, 30% faster than our current blades	77	9.8-18.1	HSS		5	B-06476
	B-52	5-50	5-50	3-35	3-5	3-8	For material combinations, like sandwich boards	77	5.5-9.8	HSS		5	B-06482

GRINDING

SANDING / POLISHING





SAWING

MULTI-TOOL

## Jig Saw Blade assortment

These blades are a 'Bayonet fit', and can be used with most models of jigsaws.







- For Model: DJV180, JV100D, JV101D, JV102D, JV103D, JV183D, DJR185, JR105D, 4326, 4327, 4329, 4350CT/FCT, 4351FCT, JR1000FT

Type	No	Application	Package	Part No.
	No.1 No.2 No.3 No.8 10S	-	5 different jig saw blades in one single pack	A-86882
	B-10S B-13 B-16 B-22 B-23	-	5 different jig saw blades in one single pack	A-86898
	B-50 B-51 B-52	-	3 different jig saw blades in one single pack	B-06292
	BR-13	Wood	100pcs in one single box	B-07777

## Jig Saw Blades (Standard Range) - D-series

The blades are with T-Shank and suitable for use with any Makita or other brand Jigsaw machines which have T shank connection.



Shape	No	Wood Plywood (mm)	Plastics (mm)	Aluminium (mm)	Stainless Steel (mm)	Mild Steel (mm)	Features / Application	Working Length (mm)	Tooth Per Inch	Material	Type of cutting	Per pkg.	Part No.
	4-50						Wood / Basic (Equivalent to B-13)	74	8	HCS		5	D-34877
	4-50						Wood / Fast (Equivalent to B-16)	50	6	HCS		5	D-34883
					1-3		Metal / Basic (Equivalent to B-22)	51	21	HSS		5	D-34908
	4-50						Wood / Finish (Equivalent to B-10)	74	9	HCS		5	D-44214 / D-72718



OPE

JOBSITE TOOLS





SPECIALTY TOOLS

CARRY CASE / TOOL HOLDERS / POUCHES



## Sanding and Filing for Jig Saw

Shape	Applications (mm)	Features / Recommended Use	Overall Length (mm)	Working Length (mm)	Pc Per Pkg	Part No.
	Wood	Sanding adapter (Use with Abrasive paper)	153	90	1	A-40967
	Metal	File (Flat Type)	153	60	3	A-40951

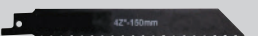
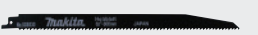

## Recipro Saw Blade for Wood

Type	No	Teeth per inch	Overall length (mm)	Application	Tooth Material	Per pkg.	Part No.
<b>WOOD / BASIC</b>							
	No.23	9	165	For wood 5mm - 90mm	HCS	5	792148-9
	No.3020	10	150	For wood, plywood 5mm - 90mm	HCS	5	A-02319
	No.3023	10	250	For thick wood 5mm - 190mm	HCS	5	B-00767
<b>WOOD / FAST</b>							
	No.23B	6	150	For fast finish work in wood 10mm - 90mm	HCS	5	792707-9
	No.3019	4	150	For fast and rough cutting in thick wood: 20mm - 90mm	HCS	5	A-02303
	No.3030	6	300	For roughing work in thick wood 10mm - 250mm	HCS	5	B-03030

## Reciprocating Saw Blade for Metal

Type	No	Teeth per inch	Overall length (mm)	Application	Tooth Material	Per pkg.	Part No.
	No.21	24	125	For steel plate 1.5mm - 3.0mm For iron pipe 50mm dia. or less	HSS	5	792146-3
	No.22	18	165	For steel plate, aluminum 3.0mm - 5.0mm For iron pipe 90mm dia. or less	HSS	5	792147-1
	No.24	24	165	For steel plate 1.5mm - 3.0mm For iron pipe 90mm dia. or less	HSS	5	792149-7

## Reciprocating Saw Blade for Wood / Metal (Heavy) (long life)

Type	Teeth per inch	Overall length (mm)	Blade Thickness (mm)	Application	Tooth Material	Per pkg.	Part No.
	6-8	152	1.25	Wood with nails/metal, chipboards (10-100mm), plastics/Glass fibre reinforced plastics (10-100mm), wooden pallets	TC/HM	1	B-49834
	6-8	228	1.25	Wood with nails/metal, chipboards (10-175mm), plastics/Glass fibre reinforced plastics (10-175mm), wooden pallets	TC/HM	1	B-49840
	6-8	305	1.25	Wood with nails/metal, chipboards (10-250mm), plastics/Glass fibre reinforced plastics (10-250mm), wooden pallets	TC/HM	1	B-49856

## Reciprocating Saw Blade for Bi-Metal

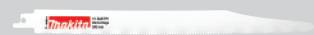
Type	No	Teeth per inch	Overall length (mm)	Application	Tooth Material	Per pkg.	Part No.
	10	300		For cuts in thick metal	Bi Metal	3	P-46981

DRILLING / FIXING

CONCRETE DRILLING / DEMOLITION

MIXING / STIRRING

CUTTING (CONCRETE / METAL)

GRINDING

SANDING / POLISHING

SAWING

MULTI-TOOL

ROUTERS / PLANERS

NAILERS / STAPLERS

HEAT GUN / LASER

CLEANING

OPE

JOB SITE TOOLS

SPECIALTY TOOLS

CARRY CASE / TOOL HOLDERS / POUCHES

## Reciprocating Saw Blade for Insulation Material

Specially designed knife shaped Reciprocating Saw Blades are suitable for cutting insulation materials such as Urethane or Glass Wool.

- (1) Width of the blade  
Blades are designed with more width for steady cutting (400mm)

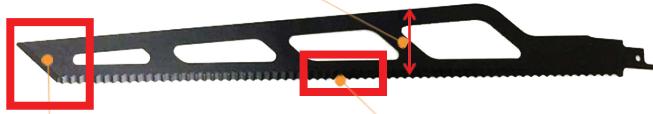

- (2) Shape of blade top.  
The blade top is also ground to do plunge cut by inserting the blade into the material.
- (3) Knife shape blade.  
Blade teeth are different from the regular Reciprosaw Blade, its ground from both ends which are corrugated.



Type	No	Thickness	Overall length (mm)	Working Length (mm)	Application	Tooth Material	Per pkg.	Part No.
		1.5	225	205	Insulation Material, Glass Wool, Stone Wool (10-175mm)	HCS	2	B-52118
		1.5	300	280	Insulation Material, Glass Wool, Stone Wool (10-250mm)	HCS	2	B-52124
		1.5	400	320	Insulation Material, Glass Wool, Stone Wool (10-300mm)	HCS	1	B-52130

## Reciprocating Saw Blade Super Express (5pcs per pack)

Type	No	Teeth per inch	Overall length (mm)	Application	Tooth Material	Per pkg.	Part No.
	No.21	7-18	152	Fast Cut for metal. (Iron/steel: 1.5 - 8.0mm, Plastic 5-77mm)	Bi-Metal	5	B-05038
	No.22	6-11	152	Fast cuts in non-ferrous metal, aluminium, plastics and wood with nails, steel (Iron/steel: 5-8mm, Plastics: 5-77mm, Wood: 5-77mm)	Bi-Metal	5	B-05044
	No.24	6-10	203	For fast cuts in wood	HCS	5	B-05153

## Reciprocating Saw Blade Super Express (2pcs per pack)

Type	No	Teeth per inch	Overall length (mm)	Application	Tooth Material	Per pkg.	Part No.
	No.21	7-18	152	Fast Cut for metal. (Iron/steel: 1.5 - 8.0mm, Plastic 5-77mm)	Bi-Metal	2	B-05038-2
	No.22	6-11	152	Fast cuts in non-ferrous metal, aluminium, plastics and wood with nails, steel (Iron/steel: 5-8mm, Plastics: 5-77mm, Wood: 5-77mm)	Bi-Metal	2	B-05044-2
	No.24	6-10	203	For fast cuts in wood	HCS	2	B-05153-2

## Reciprocating Saw Blade for Aerated concrete, Soft brick

Type	Teeth per inch	Overall length (mm)	Working Length mm	Thickness mm	Application	Tooth Material	Per pkg.	Part No.
	2	400	375	1.5	Specially Suitable: Aerated Concrete, Fire-brick, Sand stone, Gypsum Suitable: Vertical Coring Brick, Solid Brick, Clinker, Mortar	TC/HM	2	B-63591
	2	455	420	1.5	Specially Suitable: Fire-brick, Sand stone, Gypsum Suitable: Aerated Concrete	TC/HM	1	B-10403

### Scroll Saw Blade



For Model	PC / Pkg	Part No.
SJ401 (Scroll saw blade)	1	(SJ)351011-000

DRILLING / FIXING

CONCRETE DRILLING / DEMOLITION

MIXING / STIRRING

CUTTING (CONCRETE / METAL)

### Band Saw Blades

For Model: LB1200F



Blade type	Width x Length (mm)	Thickness	Teeth Per Inch (TPI)	Application	Pcs per package	Part No.
HCS	13 X 2240mm	0.5	4	Wood / Universal	3	B-16673
HCS	16 X 2240mm	0.5	4	Wood / Cross-cut	3	B-16667
HCS	6 X 2240mm	0.5	6	Wood / Curve-cut	3	B-16689
HCS	16 X 2240mm	0.5	14	Nonferrous metal	3	B-16695

GRINDING

SANDING / POLISHING

SAWING

MULTI-TOOL

### Portable Band Saw Blades

For Model : PB002G / DPB180 / 2106/ 2106W / 2107FK



Blade type	WX L (mm)	Thickness (mm)	Thickness of work piece	Teeth Per Inch (TPI)	Application	Pcs per package	Part No.
Carbon steel	1140 x 13mm	0.5	-	6	Wood	3	792567-9
Carbon steel	1140 x 13mm	0.5	More than 5mm	14	Plastics and non ferrous metals. Mild steel, cast steel and cast iron	3	792560-3
Carbon steel	1140 x 13mm	0.5	4 - 5mm	18		3	792559-8
Carbon steel	1140 x 13mm	0.5	Less than 4mm	24		3	792558-0
Bi-Metal	1140 x 13mm	0.5	More than 5.5mm	10		1	B-30128
Bi-Metal	1140 x 13mm	0.5	More than 5mm	14	Plastics and non ferrous metals. Mild steel, cast steel and cast iron. Hard steel and stainless steel	1	792557-2
Bi-Metal	1140 x 13mm	0.5	4 - 5mm	18		1	792556-4
Bi-Metal	1140 x 13mm	0.5	Less than 4mm	24 WAVE TEETH		1	194692-6

ROUTERS / PLANERS

NAILERS / STAPLERS

HEAT GUN / LASER

CLEANING

OPE

JOBSITE TOOLS

For Model: DPB181 / DPB182 / DPB183

Blade type	WX L (mm)	Thickness (mm)	Thickness of work piece	Teeth Per Inch (TPI)	Application	Pcs per package	Part No.
Bi-Metal	835 x 13mm	0.5	3mm-6 mm	14 WAVE TEETH	Plastics and non-ferrous metal. Mild steel, cast steel and cast iron. Hard steel and stainless steel.	5	B-40543
Bi-Metal	835 x 13mm	0.5	2 mm- 3 mm	18 WAVE TEETH		5	B-40559
Bi-Metal	835 x 13mm	0.5	less than 2mm	24 WAVE TEETH		5	B-40565







SPECIALTY TOOLS

HAND TOOLS / COMBINATION SET

TOOL HOLDERS AND POUCHES / MAKPAC SYSTEM

DRILLING / FIXING
CONCRETE DRILLING / DEMOLITION
MIXING / STIRRING
CUTTING (CONCRETE / METAL)
GRINDING
SANDING / POLISHING
<b>SAWING</b>
MULTI-TOOL
ROUTERS / PLANERS
NAILERS / STAPLERS
HEAT GUN / LASER
CLEANING
OPE
JOBSITE TOOLS
SPECIALTY TOOLS
HAND TOOLS / COMBINATION SET
TOOL HOLDERS AND POUCHES / MAKPAC SYSTEM



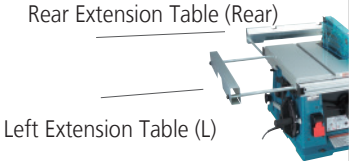

## Table and stand

		
<b>For Model</b> Table Saw MLT100 , 2703	<b>Part No</b> JM27000300	<b>For Model</b> Table Saw 2703, 2704
		<b>Part No</b> 194093-8
		<b>For Model</b> Miter Saws: LS1440, LS1013, LS1214, LS1045, LS1030
		<b>Part No</b> P-63750
<b>Portable Miter Saw Stand</b> 	<b>Folding Miter Saw Stand</b> Max extension length: 2,550mm Min length: 1,150 mm 	<b>Folding Miter Saw Stand</b> Max extension length: 3,830mm Min length: 1,765 mm 
<b>For Model</b> All slide compound saw, Miter saw, Table top miter saw	<b>Part No</b> WST05	<b>For Model</b> All slide compound saw, Miter saw, Table top miter saw
		<b>Part No</b> WST06
		<b>For Model</b> All slide compound saw, Miter saw, Table top miter saw
		<b>Part No</b> WST07
		
<b>For Model</b> Table Saw: 2704	<b>Part No</b>	
	Rear	194087-3
	L	194086-5

## Guide Rail and Guide Rail Accessories

- For use with Makita Plunge Saw SP001G, SP6000, DSP600, DSP601
- Interacts with the saw base and engineered to deliver smooth, dead-on straight or bevel cutting
- Ideal for ripping sheet material



For Model	Overall length (m)	Part No.
For Plunge cut Saw models SP001G, SP6000, DSP600, DSP601 Use the guide rail adapters to connect the guide rail with circular saws, jig saws, routers, trimmers, cutters	1.4 m	194368-5
	3.0 m	194367-7
Kickback reduction stopper for guide rails	-	1913J9-2 ■
Guide rail connector - For linking Makita guide rails together 	-	198885-7
Splinter guide for Guide rail 	3.0 m	423360-7
Parallel guide - allows a long ruler to be set parallel to any position from the end face of the material 		1913K7-3 ■
Guide Rail bag 	1.4 m	B-57613

## Guide Rail Adaptor



Items	Circular saw			Jig saw		Router Trimmer	Cutter	
	Models							
	DHS680	HS0600	DHS660 DHS661	DJV180 4350CT 4350FCT 4351FCT	JV102D JV103D DJV184	*RT001G *DRT50 *RT0702C 3612BR RP0900 RP1800 RP2300FC	DCC500 DCC501 4100KB 4100NH2	
<b>Part No.</b>	196953-0	198566-3	199232-5	193517-1	198704-7	194579-2	198673-2	

\* Use with Plunge base assembly (P/N:195563-0)

## Clamp Set

		Type	Part No.
	A	A	194385-5
	B	B	199826-6
	Extrusion clamps (to fix a long ruler or material by thrusting it back and forth)		

## Guide Rule (Rip Fence)

Type	For Model	Part No.
Guide rule for circular saws 	RS001G, RS002G	199249-8
	DCS553, DHS660, DHS661, DHS680 5800NB, 5806B, 5057KB, 5007N, 5600NB, 5604R, 5704R, 5740NB DHS781, DHS782, DSS501, HS004G	164095-8
	5900B	164021-7
	DHS901, N5900B, HS0600	164367-1
	5103N, 5201N, 5401N, 5402	164019-4
	5903, 5903R	165084-6
	SP6000 (Sub base)	165447-6
	DRS780	165153-3
	HS012G (bevel guide)	■ 196664-7
	Guide rule for slide compound / miter saws	LS1211
LS1013		316840-9
LS1045		316826-3
Guide rule for Jigsaws A: Guide rule & circular guide set B: Circular guide assembly 	4300BV, 4300BA	- 164113-2
	4304, 4304T, 4305	- 192424-5
	4326/M, 4327/M, 4328, 4329, JV100D, JV102D, JV103D, JV183D	A 192732-4
	4350T/CT,/FCT, 4351FCT, DJV180	A 193516-3
	4300BA/BV	B 123030-5
	4304/T, 4331D, 4305	B 192561-5

DRILLING  
/ FIXINGCONCRETE  
DRILLING /  
DEMOLITIONMIXING /  
STIRRINGCUTTING  
(CONCRETE /  
METAL)

GRINDING

SANDING /  
POLISHING

SAWING

MULTI-TOOL

ROUTERS /  
PLANERSNAILERS /  
STAPLERSHEAT GUN /  
LASER

CLEANING

OPE

JOBSITE  
TOOLSSPECIALTY  
TOOLSHAND TOOLS /  
COMBINATION SETTOOL HOLDERS  
AND POUCHES /  
MAKPAC SYSTEM

DRILLING /  
FIXINGCONCRETE  
DRILLING /  
DEMOLITIONMIXING /  
STIRRINGCUTTING  
(CONCRETE /  
METAL)

GRINDING

SANDING /  
POLISHING

SAWING

MULTI-TOOL

ROUTERS /  
PLANERSNAILERS /  
STAPLERSHEAT GUN /  
LASER

CLEANING

OPE

JOBSITE  
TOOLSSPECIALTY  
TOOLSHAND TOOLS /  
COMBINATION SETTOOL HOLDERS  
AND POUCHES /  
MAKPAC SYSTEM

## Rip Fence Assembly



For Model	Part No.
2704	122740-1
LF1000	122729-9
LH1040	122707-9
2702, 2703	122556-4
2708	122284-1
MLT100	JM27000202
LH1201FL	JM23300008

## Vice Assembly



### Vertical vice assembly

For Model	Part No.
LS1040	122536-0
LS0714, DLS714, DLS713	122571-8
LS1212, LS1030	192672-6
LH1040	192625-5
LS1214/F, LS1013	122538-6
LS1212, LS1214	122540-9
LS1016, LS1216	122854-6
DLS211, DLS111, LS1019L, LS1219L LS1016, LS1216, LS004G, LS003G	126617-2
LS1018L, LH1201FL	JM23100502

### Horizontal vice assembly



For Model	Part No.
DLS211, DLS111, LS1019L, LS1219L LS1016, LS1216, LH1201FL, LS004G, LS003G	122470-4
LS1440, LS1045, LS1040, LH1040	122563-7
LS1510	134529-5
LS0714, DLS713, DLS714, LS002G	122567-9
LS1216, LS1219L, LS1018L	122930-6

### Sub base assembly set

LS004G	191U61-8
DLS111, DLS211, LS1019L, LS1219L	191C01-8

## Bevel Guide

For use with Makita Plunge Circular Saws and with Makita guide rails 194368-5 or 194367-7

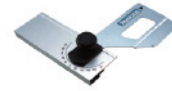

For Model	Part No.
SP001G, DSP600, DSP601, SP6000	196664-7 ■

## Anti-splintering device for jig saw

For cleaner cutting

For Model	Part No.
4326, 4327, 4329, 4350CT, 4350FCT, 4350T, 4351CT, 4351FCT, 4351T, DJV180, JV101D, JV102D, JV103D, JV183D	192557-6

## Cover Plate for jig saw

For Model	Part No.
4326, 4327, 4329, 4350CT, 4350FCT, 4350T, 4351CT, 4351FCT, 4351T, DJV180, JV101D, JV102D, JV103D, JV183D	417852-6
DJV184, DJV185, JV001G, JV102D, JV103D	457867-1 ■

## Crown molding stopper set

For Model	Part No.
DLS110, DLS111, DLS112, DLS211, DLS212, LS003G, LS004G, LS1019, LS1019L, LS1219, LS1219L	192628-9

## Blade Clamp Assembly

For use of 6.35mm Universal Shank Blades



For Model	Part No.
Jig saw - 4300BA / BV	132276-260



### Dust Bag Assembly & Dust Box Set



A: Dust bag assembly



B: Dust box set

For Model	Type	Part No.
LS1011, LS1020, LS1030	A	122351-2
LS1211	A	122469-9
LS1440	A	122330-0
DLS714, LS0714, LS1040, LF1000	A	122523-9
DLS111, DLS211, LS1219L, LS1019L, LH1040 LS004G, LS003G	A	122852-0
LS1018L	A	JM23100501
LS0714, LS1013, LS1214, LS1016, LS1216	B	194175-6
LS002G	A	127512-9
SP001G, DSP600, DSP601	A	126599-8
SP6000	A	122562-9

### Safety Goggles



	Part No.
Safety wear	191686-2

### Cut-out Tool Accessories

#### Drywall Guide Bit



For Model	Size	Type	Part No.
3706	3.8mm 1/8"	-	733229-0
3706	6.35mm 1/4"	-	733232-1
DCO181 / 3706	6.35mm 1/4"	Diamond bit	A-87915
DCO181 / 3706	6.35mm 1/4"		193447-6
DCO181 / 3706	3.8mm 1/8"	-	191G69-8
DCO181 / 3706	3.8mm 1/8"	(5pcs/pkg)	191G68-0
DCO181 / 3706	3mm	-	193450-7

#### Flash Bit



For Model	Size	Part No.
DCO181	6 x 6mm	D-08218

#### Circular Guide



For Model	Part No.
DCO181, 3706	193448-4

#### Collet Sleeve



Collet sleeve for 3.8mm bit

For Model	Part No.
3706	324149-5

#### Collet Cone / Collet Nut



\*With Poly bag & header

For Model	Size	Part No. Collet Cone	Part No. Collet Nut
3706	6.35mm 1/4"	763608-8	763606-2
DCO181	6.35mm 1/4"	*197038-5	763258-9
DCO181	6.35mm 1/4"	763676-1	
DCO181	3.8mm 1/8"	763677-9	
DCO181	6mm	763678-7	
DCO181	3mm	763679-5	

DRILLING / FIXING

CONCRETE DRILLING / DEMOLITION

MIXING / STIRRING

CUTTING (CONCRETE / METAL)

GRINDING

SANDING / POLISHING

SAWING

MULTI-TOOL

ROUTERS / PLANERS

NAILERS / STAPLERS

HEAT GUN / LASER

CLEANING

OPE

JOBSITE TOOLS

SPECIALTY TOOLS

HAND TOOLS / COMBINATION SET

TOOL HOLDERS AND POUCHES / MAKPAC SYSTEM

# Multi Tool / Multi Cutter

For various Applications



Cutting PVC, FRP pipes



Routing joints on wall tiles



Wood flush cutting



Metal flush cutting



Sanding/polishing various materials



Corner cutting



Wood plunge cutting



Flush cutting of nails



Scraping floor tiles



Cutting tiles



Deep plunge cutting



Cutting polystyrene, rubber



Removing mortar, tile adhesive



Cutting plasterboards



Cutting window putty, silicone



Cutting metals



**DTM52** 18V | **LXT**

**Cordless Multi Tool**



**Compatible with STARLOCK / STARLOCK MAX accessories**

- Tool-less accessory changes with lever locking system
- Variable speed dial 10,000 - 20,000 OPM no load speed for versatile performance
- 12 angle settings of accessories at every 30° from 0° to 360°
- 2.5m/s<sup>2</sup> or less of vibration thanks to AVT (Anti-Vibration Technology)
- Small and easy to grip 169mm diameter barrel grip for comfortable and improved handling

**18V PREMIUM MOTOR BL XPT AVT**

<b>Oscillations Per Minute (OPM)</b>	10,000 - 20,000
<b>Oscillation Angle</b>	Left / Right / Total: 1.8° / 1.8° / 3.6°
<b>Circumference of Grip Portion</b>	169 mm
<b>Dimensions (L x W x H)</b>	322 x 95 x 126 mm
<b>Net weight</b>	1.3 kg (without battery)

**AVAILABLE VARIANTS**

<b>3.0Ah</b>	<b>"Z" VARIANT</b>
<b>DTM52 RFJX1</b> INCLUDES 2 BATTERIES / 1 CHARGER / MULTI TOOL ACCESSORIES / MAKPAC CONNECTOR CASE	<b>DTM52 Z</b> TOOL ONLY (DOES NOT INCLUDE BATTERY / CHARGER OR CARRY CASE)

**TM30D** 12V MAX | **CXT**

**Cordless Multi Tool**



**High power, Wide selection of accessories available for various applications high cutting efficiency**

- 12 angle setting of accessories at every 30° from 0° to 360°
- Ergonomically designed rubberized grip provides more control and comfort.
- Anti-restart function prevents accidental start-up.
- Variable speed control by dial

**12Vmax BLX MOTOR CXT**

<b>Oscillations per minute (opm)</b>	6,000-20,000
<b>Dimensions (L x W x H)</b>	277x65x98mm
<b>Net weight</b>	1.1kg

**Standard Equipment:** Hex Wrench

**AVAILABLE VARIANTS**

<b>2.0Ah</b>	<b>"Z" Version</b>
<b>TM30DWAJ</b> INCLUDES 2 BATTERIES / 1 CHARGER / MAKPAC CASE	<b>TM30DZ</b> TOOL ONLY (DOES NOT INCLUDE BATTERY / CHARGER OR CARRY CASE)

**TM3010CK** 

**Multi Tool**



**Equipped with the tool-less accessory change system.**

- Wide selection of accessories available for various applications.
- Anti-restart function prevents accidental startup.
- Fully 360° multi angle setting enables users to position accessories in 12 different angles.
- Ergonomically designed rubberized grip provides more control and comfort. Variable speed control dial.

**459mm**

<b>Continuous rating Input</b>	320W
<b>Strokes per minute (spm)</b>	6,000-20,000
<b>Dimensions (L x W x H)</b>	283x68x87mm (11-1/8" x 2-11/16" x 3-7/16")
<b>Net Weight</b>	1.6kg (3.7lbs)
<b>Power supply cord</b>	2.5m (8.2ft)

**Accessory Compatibility**

	OIS	STARLOCK MAX	STARLOCK
DTM52	✗	✓	✓
TM30D	✓	✗	✓
TM3010CK	✓	✗	✓

**CP100D** 85mm 12V MAX | **CXT**

**Cordless Multi Cutter**



**Cuts thin and thick material up to 6 mm such as cardboard, carpet, fabrics, leather, CD, DVD & Blu-ray disc**

- Auto self-sharpening function maintains sharp cutting performance
- Large Work Amount on a Single Battery Charge
- High power satisfies even professional needs such as carpet contractors
- Handy size for easy maneuverability in various applications for home / professional use

**12Vmax BLX MOTOR CXT**

<b>Max Cutting Capacity</b>	6 mm (1/4")
<b>No Load Speed (RPM)</b>	300
<b>Dimensions (L x W x H)</b>	with BL1021B: 272x66x120 mm
<b>Net weight</b>	0.72kg



**Accessories**  
Cutter Blade with Lock pin Part No. 198603-3

**AVAILABLE VARIANTS**

<b>2.0Ah</b>	<b>"Z" Version</b>
<b>CP100D SA1J</b> INCLUDES 1 BATTERY / 1 CHARGER / MAKPAC CONNECTOR CASE	<b>CP100D Z</b> TOOL ONLY (DOES NOT INCLUDE BATTERY / CHARGER OR CARRY CASE)

- DRILLING / FIXING
- CONCRETE DRILLING / DEMOLITION
- MIXING / STIRRING
- CUTTING (CONCRETE / METAL)
- GRINDING
- SANDING / POLISHING
- SAWING
- MULTI-TOOL
- ROUTERS / PLANERS
- NAILERS / STAPLERS
- HEAT GUN / LASER
- CLEANING
- OPE
- JBSITE TOOLS
- SPECIALTY TOOLS
- HAND TOOLS / COMBINATION SET
- TOOL HOLDERS AND POUCHES / MAKPAC SYSTEM

# Multi Tool - Starlock Accessories Applications

- DRILLING / FIXING
- CONCRETE DRILLING / DEMOLITION
- MIXING / STIRRING
- CUTTING (CONCRETE / METAL)
- GRINDING
- SANDING / POLISHING
- SAWING
- MULTI-TOOL**
- ROUTERS / PLANERS
- NAILERS / STAPLERS
- HEAT GUN / LASER
- CLEANING
- OPE
- JOBSITE TOOLS
- SPECIALTY TOOLS
- HAND TOOLS / COMBINATION SET
- TOOL HOLDERS AND POUCHES / MAKPAC SYSTEM



		Width (mm)	Teeth per inch	Blade Material	Curve Teeth	Wood					Metal			
						Wood	Plywood	Chipboard	Laminate	Plaster board	Non ferrous metal	Sheet metal	Stainless	Soft nail
<b>STARLOCK</b>	TMA046	100	15	BiM		✓	✓	✓	✓	✓	✓			✓
	TMA048	65	20	BiM	●	✓	✓	✓	✓	✓	✓	✓		✓
	TMA057	10	20	BiM		✓	✓	✓	✓	✓	✓	✓		✓
	TMA058	20	20	BiM		✓	✓	✓	✓	✓	✓	✓		✓
	TMA049	85	18	HCS		✓	✓	✓	✓					
	TMA050	24	18	HCS		✓	✓	✓	✓					
	TMA051	32	18	HCS	●	✓	✓	✓	✓					
	TMA079	45		TC		✓	✓	✓	✓	✓	✓	✓	✓	✓
	TMA063	100	-	BiM										
	TMA064	85	18	BiM		✓	✓	✓	✓	✓	✓	✓		✓
	TMA065	52	-	HCS										
	TMA067	28	-	HCS										
	TMA080	32	20	TC	●	✓	✓	✓	✓	✓	✓	✓	✓	✓
	TMA081	53	14	BiM	●	✓		✓		✓				
	TMA082	12	-	Stainless										
	TMA069	85	-	TC #30					✓					
	TMA071	70	-	TC #50					✓					
	TMA073	78	-	TC #20		✓								
	TMA074	70	-	TC #40					✓					
	TMA083	90	-	TC #20		✓	✓	✓						
TMA084	90	-	TC #40		✓	✓	✓							
TMA085	90	-	TC #60		✓									
TMA086	90	-	TC #100		✓									
<b>STARLOCK MAX</b>	MAM001	32	20	BiM	●	✓	✓	✓	✓	✓	✓			✓
	MAM002	52	18	BiM	●	✓	✓	✓	✓	✓	✓			✓
	MAM005	32	23	TC		✓	✓	✓	✓	✓	✓	✓	✓	✓
	MAM006	32	20	TC	●	✓	✓	✓	✓	✓	✓	✓	✓	✓
	MAM008	32	-	HCS										
	MAM012	68	-	Diamond					✓					

COLOUR CODING FOR APPLICATION

Rating Suitability for application: ✓ = Suitable Blank = No Rating

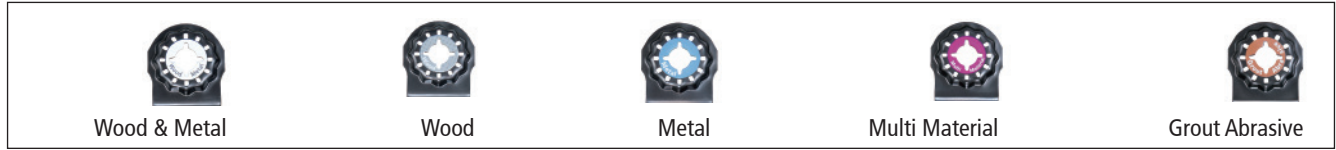

Wood & Metal

Wood

Metal

Multi Material

Grout Abrasive

# Multi Tool - Starlock Accessories Applications



Multi Material						Grout Abrasive			Curve Teeth	Blade Material	Teeth per inch	Width (mm)	Model
Epoxy	Fiber glass	Linoleum Carpet	Carpet adhesive	Insulation material	Soft joint material	Porous Concrete Soft brick	Soft wall tiles	Mortar Tile adhesive					
✓	✓									BiM	15	100	TMA046
✓	✓								•	BiM	20	65	TMA048
✓	✓									BiM	20	10	TMA057
✓	✓									BiM	20	20	TMA058
✓										HCS	18	85	TMA049
✓										HCS	18	24	TMA050
									•	HCS	18	32	TMA051
✓	✓									TC	23	45	TMA079
		✓	✓	✓						BiM	-	100	TMA063
✓	✓									BiM	18	85	TMA064
			✓							HCS	-	52	TMA065
					✓					HCS	-	28	TMA067
✓	✓								•	TC	20	32	TMA080
✓									•	BiM	14	53	TMA081
					✓					Stainless	-	12	TMA082
✓	✓					✓	✓	✓		TC #30	-	85	TMA069
✓	✓					✓	✓	✓		TC #50	-	70	TMA071
✓								✓		TC #20	-	78	TMA073
✓	✓					✓		✓		TC #40	-	70	TMA074
	✓							✓		TC #20	-	90	TMA083
	✓							✓		TC #40	-	90	TMA084
								✓		TC #60	-	90	TMA085
								✓		TC #100	-	90	TMA086
✓	✓								•	BiM	20	32	MAM001
✓	✓								•	BiM	18	52	MAM002
✓	✓					✓				TC	23	32	MAM005
✓	✓					✓			•	TC	20	32	MAM006
				✓	✓					HCS	-	32	MAM008
✓	✓					✓	✓	✓		Diamond	-	68	MAM012

COLOUR CODING FOR APPLICATION

Rating Suitability for application: ✓ = Suitable Blank = No Rating

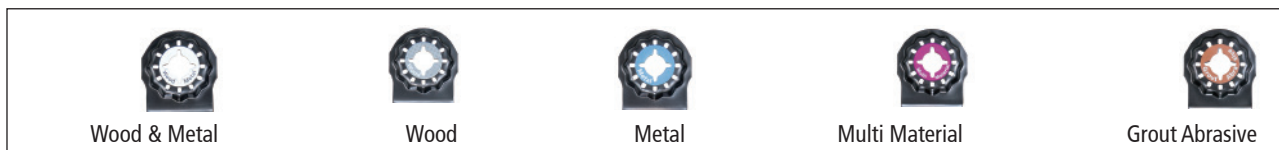

- DRILLING / FIXING
- CONCRETE DRILLING / DEMOLITION
- MIXING / STIRRING
- CUTTING (CONCRETE / METAL)
- GRINDING
- SANDING / POLISHING
- SAWING
- MULTI-TOOL**
- ROUTERS / PLANERS
- NAILERS / STAPLERS
- HEAT GUN / LASER
- CLEANING
- OPE
- JOB SITE TOOLS
- SPECIALTY TOOLS
- HAND TOOLS / COMBINATION SET
- TOOL HOLDERS AND POUCHES / MAKPAC SYSTEM

**STARLOCK**

**STARLOCK MAX**

# STARLOCK MAX

DRILLING / FIXING

## Plunge Cut Saw Blade (bow shape)

MAM001   **STARLOCK MAX**

**Application/ Recommended Use**  
Especially suitable for Wood & Metal  
Feature : Suitable for Precisely Plunge Cut, Deep and Fast Cutting  
Another material: Epoxy, Fibreglass

Blade width (mm)	Tpi	Type	Per pkg.	Part No.
32 x 80	20TPI	BiM, Wood & Metal	1	B-66400

CONCRETE DRILLING / DEMOLITION

MIXING / STIRRING

CUTTING (CONCRETE / METAL)

## TC bar plunge cut saw blade (bow shape)

MAM006   **STARLOCK MAX**

**Application/ Recommended Use**  
Especially suitable for Multi Material  
Feature : Suitable for Precisely plunge cut , Deep and fast cutting  
Another material: Wooden material , Epoxy, Fibreglass, Porous Concrete

Size (mm)	Tpi	Type	Per pkg.	Part No.
32 x 70	20TPI	TC/HM, Multi Material	1	B-66450

GRINDING

SANDING / POLISHING

SAWING

## Plunge cut saw blade

MAM002   **STARLOCK MAX**

**Application/ Recommended Use**  
Especially suitable for Wood & Metal  
Feature : Suitable for Precisely plunge cut , Deep and wide cutting  
Another material: Epoxy, Fibreglass

Blade width (mm)	Tpi	Type	Per pkg.	Part No.
52 x 70	18TPI	BiM, Wood & Metal	1	B-66416

## Joint cutter blade

MAM008   **STARLOCK MAX**

**Application/ Recommended Use**  
Especially suitable for Multi Material  
Feature : Suitable for Soft joint material cut , Deep and wide cutting

Size (mm)	Type	Per pkg.	Part No.
32 x 55	HCS, Multi Material	1	B-66472

MULTI-TOOL

ROUTERS / PLANERS

NAILERS / STAPLERS

## TC bar plunge cut saw blade

MAM005   **STARLOCK MAX**

**Application/ Recommended Use**  
Especially suitable for metal  
Feature : Suitable for Plunge cut , Deep and fast cutting  
Another material: Epoxy, Fibreglass, Porous Concrete, Wooden material

Blade width (mm)	Tpi	Type	Per pkg.	Part No.
32 x 70	23TPI	TC/HM, Metal	1	B-66444

## Diamond segment blade

MAM012   **STARLOCK MAX**

**Application/ Recommended Use**  
Feature : Suitable for Cutout of soft wall tile  
Another material: Plasterboard, Epoxy, Fibreglass

Blade width (mm)	Thickness	Type	Per pkg.	Part No.
68 x 10	1.5mm	Diamond Grit #40	1	B-66525

# STARLOCK



HEAT GUN / LASER

CLEANING

OPE

JOBSITE TOOLS

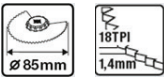

## Segment saw blade 85

TMA049   **STARLOCK**

**Application/ Recommended Use**  
Wood/ Suitable for flush cutting  
Plunge-cut in solid wood  
Cut-off plastic pipe(PVC) to length

Diameter (mm)	Type	Per pkg.	Part No.
85	HCS, Wood	1	B-64836

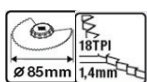

## Segment saw blade 85

TMA064   **STARLOCK**

**Application/ Recommended Use**  
Non-ferrous metal, FRP, PVC / Suitable for corners.  
Plunge cut in plasterboard or cement-bonded fiber boards  
Cut-off smaller mouldings to length  
Cutting recesses in epoxy/glass fiber reinforced plastic

Diameter (mm)	Type	Per pkg.	Part No.
85	BiM-TiN, Multi Material	1	B-64973

## Segment saw blade

TMA045   **STARLOCK**

**Application/ Recommended Use**  
Wood&Metal/ Suitable for flush cutting  
Cut-off door frame to length on the floor  
Cut-out parquet/laminate flooring  
Cut-off smaller mouldings to length

Diameter (mm)	Type	Per pkg.	Part No.
85	BiM, Wood&Metal	1	B-64799
100	BiM, Wood&Metal	1	B-64808

SPECIALTY TOOLS

HAND TOOLS / COMBINATION SET

TOOL HOLDERS AND POUCHES / MAKPAC SYSTEM

## Serrated segment blade 100



TMA063  **STARLOCK**

**Application/ Recommended Use**  
Wood and Metal / Suitable for Precisely plunge cut  
Plunge cut in hardwood

Diameter (mm)	Type	Per pkg.	Part No.
100	BiM, Multi material	1	B-64967

### Bow Shape plunge cut saw blade 65

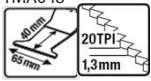
TMA048 





**Application/ Recommended Use**  
 Wood and nails/ Suitable for plunge cutting  
 Cutting wood with nails  
 Cutting a door frame to length  
 Plunge cuts in laminated panels

Size (mm)	Type	Per pkg.	Part No.
65 x 40	BiM, Wood&Metal	1	B-64820

### Plunge cut saw blade 24

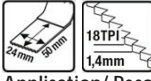
TMA050 

**Application/ Recommended Use**  
 Wood  
 Plunge-cut in softwood  
 Cutting a recess in furniture components  
 Flush cutting wooden components to length

Size (mm)	Type	Per pkg.	Part No.
24 x 50	HCS, Wood	1	B-64842
		5	B-64842-5

### Bow Shape plunge cut saw blade 32

TMA051 





**Application/ Recommended Use**  
 Wood/ Suitable for Precisely plunge cut  
 Cutting a recess in furniture components  
 Plunge-cut in softwood

Size (mm)	Type	Per pkg.	Part No.
32 x 50	HCS, Wood	1	B-64858

### Bow Shape plunge cut saw blade 32

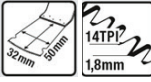
TMA053 





**Application/ Recommended Use**  
 Hard Wood/ Suitable for Precisely plunge cut  
 Plunge cut in hardwood  
 Cutting a recess in furniture components  
 Plunge cut in laminate panels

Diameter (mm)	Type	Per pkg.	Part No.
32 x 50	BiM, Wood	1	B-64870
		5	B-64870-5

### Bow Shape plunge cut saw blade 32

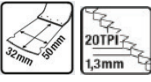
TMA047 





**Application/ Recommended Use**  
 Wood and Metal / Suitable for Precisely plunge cut  
 Plunge cut in hardwood

Size (mm)	Type	Per pkg.	Part No.
32 x 50	BiM, Wood&Metal	1	B-64814

### Plunge cut saw blade 10

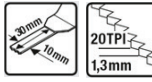
TMA057 





**Application/ Recommended Use**  
 Metal/ Suitable for flush cutting in nails or plasterboard  
 Filigree adjustment work on non-ferrous profiles  
 Plunge cuts in plasterboard

Diameter (mm)	Type	Per pkg.	Part No.
10 X 30	BiM, Wood	1	B-64917

### Plunge cut saw blade 20

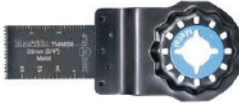
TMA058 

**Application/ Recommended Use**  
 Metal/ Suitable for flush cutting in nails or copper pipe  
 Plunge cuts in plasterboard

Diameter (mm)	Type	Per pkg.	Part No.
20 x 30	BiM, Metal	1	B-64923

### Plunge cut saw blade 32

TMA059 





**Application/ Recommended Use**  
 Metal/ Suitable for flush cutting in nails or copper pipe  
 Plunge cuts in plasterboard

Diameter (mm)	Type	Per pkg.	Part No.
32 x 50	BiM, Metal	1	B-64939

### TC Bar plunge cut saw blade 45

TMA079 





**Application/ Recommended Use**  
 Metal/ Suitable for flush cutting in nails or copper pipe  
 Plunge cuts in plasterboard

Diameter (mm)	Type	Per pkg.	Part No.
45 x 40	TC/HM, Metal	1	B-69755

### TC Bar Bow Shape plunge cut saw blade 32

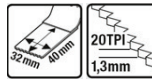
TMA080 

**Application/ Recommended Use**  
 Multi material/ Suitable for precisely plunge cut  
 Plunge cut plasterboard, fiberglass, epoxy, aluminum, stainless

Diameter (mm)	Type	Per pkg.	Part No.
32 x 40	TC/HM, Multi Material	1	B-69761

DRILLING / FIXING

CONCRETE DRILLING / DEMOLITION

MIXING / STIRRING

CUTTING (CONCRETE / METAL)

GRINDING

SANDING / POLISHING

SAWING

MULTI-TOOL

ROUTERS / PLANERS

NAILERS / STAPLERS

HEAT GUN / LASER

CLEANING

OPE

JBSITE TOOLS

SPECIALTY TOOLS

HAND TOOLS / COMBINATION SET

TOOL HOLDERS AND POUCHES / MAKPAC SYSTEM

DRILLING /  
FIXING

CONCRETE  
DRILLING /  
DEMOLITION

MIXING /  
STIRRING

CUTTING  
(CONCRETE /  
METAL)

GRINDING

SANDING /  
POLISHING

SAWING

MULTI-TOOL

ROUTERS /  
PLANERS

NAILERS /  
STAPLERS

HEAT GUN /  
LASER

CLEANING

OPE

JOBSITE  
TOOLS

SPECIALTY  
TOOLS

HAND TOOLS /  
COMBINATION SET

TOOL HOLDERS  
AND POUCHES /  
MAKPAC SYSTEM

### Bow Shape plunge cut saw blade 53

TMA081



STARLOCK



#### Application/ Recommended Use

Multi material/ Suitable for precisely and fast plunge cut in plasterboard  
1 Blade does the job of 2 (Plunge & Cut on). Cutting plasterboard, wood, epoxy

Diameter (mm)	Type	Per pkg.	Part No.
53 x 40	BiM, Multi Material	1	B-69777

### Scraper 52 Rigid

TMA0651



STARLOCK



#### Application/ Recommended Use

Removing mortar or tile adhesive  
Removing mortar and concrete residues  
Removing hard, brittle carpet adhesive residues

Diameter (mm)	Type	Per pkg.	Part No.
52 x 26	HCS	1	B-64989

### Scraper 52 Flexible

TMA066



STARLOCK



#### Application/ Recommended Use

Removing soft carpet adhesive residues  
Removing paint residues  
Removing silicone joints

Diameter (mm)	Type	Per pkg.	Part No.
52 x 40	HCS	1	B-64995

### General Joint Cutter

TMA067



STARLOCK



#### Application/ Recommended Use

Cutting soft expansion joints  
Cutting window putty  
Cutting insulation materials

Diameter (mm)	Type	Per pkg.	Part No.
28 x 40	HCS	1	B-65006

### Universal Purpose Knife

TMA082



STARLOCK



#### Application/ Recommended Use

Cutting teaksealant, caulking material

Size (mm)	Type	Per pkg.	Part No.
12 x 29	Stainless	1	B-69783

### TC Remover

TMA074

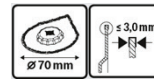

STARLOCK



#### Application/ Recommended Use

Routing joints on wall and floor tiles  
Removing mortar or tile adhesive  
Removing joints in the smallest of corners with the tungsten carbide tip

Diameter (mm)	Type	Per pkg.	Part No.
70	TC/HM grit #40	1	B-65078

### TC Seg Saw Blade 85

TMA069

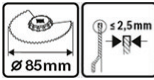

STARLOCK

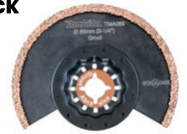

#### Application/ Recommended Use

Routing joints on wall and floor tiles  
Smaller cutouts in soft wall tiles  
Routing grooves in porous concrete, for laying concealed cables and pipes

Diameter (mm)	Type	Per pkg.	Part No.
85	TC/HM grit #30	1	B-65028

### TC Seg Saw Blade 70

TMA071

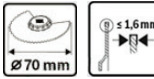

STARLOCK



#### Application/ Recommended Use

Routing extra-thin 1/16" joints on wall tiles  
Routing recesses in epoxy/glass fiber reinforced plastic  
Routing grooves in porous concrete, for laying concealed cables and pipes

Diameter (mm)	Type	Per pkg.	Part No.
70	TC/HM grit #50	1	B-65040

### Diamond Seg Saw blade 85

TMA070

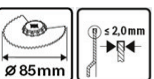

STARLOCK



#### Application/ Recommended Use

Cutout of soft wall tiles and FRP  
Routing recesses in epoxy/glass fiber reinforced plastic  
Routing joints on wall tiles

Diameter (mm)	Type	Per pkg.	Part No.
85	Diamond grit #40	1	B-65034

### TC Sanding Plate 78

TMA073



STARLOCK

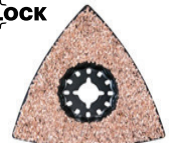

#### Application/ Recommended Use

Removing mortar or tile adhesive  
Removing carpet adhesive residues from a mineral surface

Size (mm)	Type	Per pkg.	Part No.
78	TC/HM grit #20	1	B-65062



### TC Sanding Plate 90

TMA083



**Application/ Recommended Use**  
 Removing mortar, tile adhesive, paint on fiberglass  
 Removing carpet adhesive residues from a mineral surface

**STARLOCK**



Size (mm)	Type	Per pkg.	Part No.
90	TC/HM grit #20	1	B-69799

### TC Sanding Plate 90

TMA084



**Application/ Recommended Use**  
 Sanding in wood with paint, paint of fiberglass  
 Removing mortar, tile adhesive, carpet adhesive residues from a mineral surface

**STARLOCK**



Size (mm)	Type	Per pkg.	Part No.
90	TC/HM grit #40	1	B-69808

### TC Sanding Plate 90

TMA085



**Application/ Recommended Use**  
 Sanding in wood, wood with paint roughly

**STARLOCK**

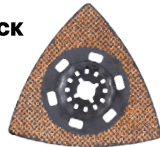

Size (mm)	Type	Per pkg.	Part No.
90	TC/HM grit #60	1	B-69814

### TC Sanding Plate 90

TMA086



**Application/ Recommended Use**  
 Sanding in wood for fine surfaces

**STARLOCK**

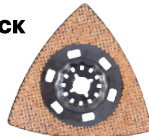

Diameter (mm)	Type	Per pkg.	Part No.
90	TC/HM grit #100	1	B-69820

### Sanding pad

TMA078



**Application/ Recommended Use**  
 Use with Riff sanding pad

**STARLOCK**



Diameter (mm)	Type	Per pkg.	Part No.
93	hook & loop	1	B-65115

### Multi tool Starlock Blade Set (with Tool box)

The components of each set are packed in tool box complete.  
 Tool box can insert to the plastic case of TM3010C, DTM51 and DTM52

**STARLOCK**



Type	Part No.
TMA045, TMA047, TMA053, TMA058, TMA078	199542-0

### Multi tool Starlock Blade Set (with Tool box)

The components of each set are packed in tool box complete.  
 Tool box can insert to the plastic case of TM3010C, DTM51 and DTM52

**STARLOCK**



Type	Part No.
TMA045, TMA047, TMA053, TMA058, TMA078	199542-0

### Multi tool Starlock Blade - Renovation Set

STARLOCK shank multi tool blade set can be attached to OIS product, STARLOCK and STARLOCK MAX

**STARLOCK**



Type	Part No.
TMA047, TMA049, TMA065, TMA073, TMA078	E-16994

### Sawing

#### Segment saw blade 65

TMA002

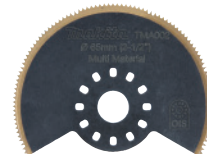
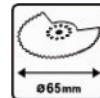

**Application/ Recommended Use**  
 Non-ferrous metal, FRP, PVC/ Suitable for corners  
 Cutting recesses in epoxy/glass fiber reinforced plastic  
 Cutting sheet metal up to 1mm  
 Removing old window putty

	Diam (mm)	Type	Part No.
OIS	65	BiM-TiN, Multi Material, flat	B-21288

### Sawing

#### Round saw blade 65

TMA004

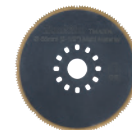
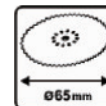

**Application/ Recommended Use**  
 Non-ferrous metal, FRP, PVC  
 Cutting recesses in epoxy/glass fiber reinforced plastic  
 Cutting sheet metal up to 1mm  
 Removing old window putty

	Diam (mm)	Type	Part No.
OIS	65	BiM-TiN, Multi Material, flat	B-21303

DRILLING / FIXING

CONCRETE DRILLING / DEMOLITION

MIXING / STIRRING

CUTTING (CONCRETE / METAL)

GRINDING

SANDING / POLISHING

SAWING

MULTI-TOOL

ROUTERS / PLANERS

NAILERS / STAPLERS

HEAT GUN / LASER

CLEANING

OPE

JBSITE TOOLS

SPECIALTY TOOLS

HAND TOOLS / COMBINATION SET

TOOL HOLDERS AND POUCHES / MAKPAC SYSTEM

**Multi tool papers applications**

Rating Suitability for application:

AA = Especially Suitable      A = Suitable      n.r = No Rating

		Grit	Product Application and Rating of Each Material	Paint	Varnish	Filler	Roughcast	Wood / Wooden materials	Soft wood	Hard wood	Plywood	Chipboard / MDF	Glass fiber reinforced plastics	Metal	Steel / (mild steel / carbon steel)	Stone	Marble	Granite	Glass	Perspex	Imitation marble	Glass fiber reinforced plastics	
Wood Long life	Coarse	60																					
	Medium	100					AA	AA	AA	AA	AA	A	AA	A									
	Fine	180																					
Wood	Coarse	60																					
	Medium	100					AA	A	AA	AA	AA	A											
	Fine	180																					
Paint	Coarse	60																					
	Medium	100	AA	AA	AA	AA				A				A	A								
	Fine	240																					
Stone	Medium	120																					
	Fine	240																					
	Fine	400	A	AA												A	A	A	A	A	A	A	A
	Very Fine	600																					
	Very Fine	1200																					

**Abrasive delta paper (Use with Sanding pad (B-65115) (hook & loop type))**

Application/ Recommended Use	Paper Size (mm)	Grit	Per Pkg	Part No.
<b>Wood / long-life</b> Application/ Recommended Use Suitable for sanding wood, hardwood, chipboard, construction boards and metal	94	60	10	B-21565
	94	100	10	B-21587
	94	180	10	B-21602
<b>Wood</b> Application/ Recommended Use Suitable for sanding wood and wooden materials	94	60	10	B-21624
	94	100	10	B-22947
	94	180	10	B-21652
<b>Paint</b> Application/ Recommended Use Suitable for sanding paint, varnish or roughcast	94	60	10	B-21680
	94	100	10	B-21705
	94	240	10	B-21711
<b>Stone</b> Application/ Recommended Use Suitable for coarse to gloss sanding of extremely hard materials such as stone or glass	94	120	10	B-21749
	94	240	10	B-21755
	94	400	10	B-21761
	94	600	10	B-21777
	94	1200	10	B-21783
<b>Fleece</b> Application/ Recommended Use Suitable for removing the rust of metal and the dirt of wood	94	Medium / 280	1	B-21799
	94	Coarse / 100	1	B-21808
	94	Without Grit	1	B-21814
<b>Polishing felt</b> Application/ Recommended Use Suitable for pre-polishing very dirty or scratched surfaces	94	Hard	1	B-21820

# Routing / Planing

Power Planer, Router, Trimmer, Sash Router



- DRILLING / FIXING
- CONCRETE DRILLING / DEMOLITION
- MIXING / STIRRING
- CUTTING (CONCRETE / METAL)
- GRINDING
- SANDING / POLISHING
- SAWING
- MULTI-TOOL
- ROUTERS / PLANERS
- NAILERS / STAPLERS
- HEAT GUN / LASER
- CLEANING
- OPE
- JOBSITE TOOLS
- SPECIALTY TOOLS
- HAND TOOLS / COMBINATION SET
- TOOL HOLDERS AND POUCHES / MAKPAC SYSTEM

**KP001G** 82 mm
40V MAX |

**Cordless Planer**



**40Vmax XGT platform and increased rotation speed of BL motor provide max cutting depth of 4.0mm similar to corded models in the same class.**

- Smooth planing for both rough planing and thin planing
- Left and right chip ejection
- Foot on base plate
- Front base with 3 chamfering grooves
- Compatible with AWS dust extractors wirelessly

	
Planing Width	82 mm
Planing Depth	4 mm
Shiplapping	25 mm (1")
No Load Speed (RPM)	15,000
Dimensions (L x W x H)	330 x 156 x 166 mm
Net weight	3.0 kg (without battery)

**Standard Equipment:** Blade Gauge, Guide Rule, Depth Guide, Socket Wrench

AVAILABLE VARIANTS	
4.0Ah	"Z" VARIANT
<b>KP001G M2</b> <small>INCLUDES 2 BATTERIES / 1 CHARGER / MAKPAC CONNECTOR CASE</small>	<b>KP001G Z</b> <small>TOOL ONLY (DOES NOT INCLUDE BATTERY / CHARGER / CARRYING CASE)</small>

**DKP181** 82mm
18V |

**Cordless Planer**





**High Power as AC Tool with BL Motor**

- Auto-start Wireless System (AWS) connects to vacuum cleaner with Bluetooth
- Automatic torque Drive Technology (ADT) adjusts cutting speed and torque during cut for optimum performance
- Angle and shape of handle are easy to grip, push and carry.
- Precise planing depth setting by adjustment knob with click stops.
- Foot on base plate protects workpiece and blades from scratches and damages.
- Rigid aluminum die-cast bracket.
- Both-side chip ejection
- Front base with 3 chamfering grooves

	
Planing width	82 mm (3-1/4")
Planing depth	3 mm (1/8")
No load speed (rpm)	12,000
Dimensions (L x W x H)	366x156x166 mm
Net weight	3.6 kg

**Standard Equipment:** Guide rule, Socket wrench

AVAILABLE VARIANTS	
5.0Ah	"Z" VARIANT
<b>DKP181 RTJ</b> <small>INCLUDES 2 BATTERIES / 1 CHARGER / MAKPAC CONNECTOR CASE</small>	<b>DKP181 Z</b> <small>TOOL ONLY (DOES NOT INCLUDE BATTERY / CHARGER OR CARRY CASE)</small>

**DKP180** 82mm (3-1/4")
18V |

**Cordless Planer**





**Angle and shape of handle are easy to grip, push and carry.**

- Precise planing depth setting by adjustment knob with click stops.
- Foot on base plate protects workpiece and blades from scratches and damages.
- Rigid aluminum die-cast bracket.

	
Planing width	82mm (3-1/4")
Planing depth	2.0mm (5/64")
No load speed (rpm)	14,000
Dimensions (L x W x H)	333x157x160mm
Net weight	3.4kg (7.4lbs)

**Standard Equipment:** Guide rule, Socket wrench

AVAILABLE VARIANTS	
"Z" VARIANT	
<b>DKP180 Z</b> <small>TOOL ONLY (DOES NOT INCLUDE BATTERY / CHARGER OR CARRY CASE)</small>	

**N1900BK** 82mm

**Power Planer**





**High power-to-weight ratio for superior performance**

- Can be used with both standard HSS planer blades and double-edged mini TCT blades.
- Simple blade setting system for fast blade installation.



	
Continuous rating Input	580W
Planing width	82mm (3-1/4")
Planing depth	1mm (1/32")
No load speed	16,000rpm
Overall length	290mm (11-3/8")
Net weight	2.8kg (6.1lbs)
Power supply cord	2.5m (8.2ft)

Shiplapping	9mm (11/32")
-------------	--------------

**Standard Equipment:** Blade Gauge Assembly, Socket Wrench, Edge Fence (Guide Rule).

**N1923BK** 82mm 

**Power Planer**

**Ideal for shiplapping cuts**

- Lightweight and excellent balance.
- Can be used with both standard HSS planer blades and double-edged mini TCT blades.
- Simple blade setting system for fast blade installation.

 **51mm**

<b>Continuous rating Input</b>	600W
<b>Planing width</b>	82mm (3-1/4")
<b>Planing depth</b>	1mm (1/32")
<b>No load speed</b>	16,000rpm
<b>Overall length</b>	293mm (11-1/2")
<b>Net weight</b>	3.1kg (6.8lbs)
<b>Power supply cord</b>	2.5m (8.2ft)
<b>Shiplapping</b>	23mm (29/32")

**Standard Equipment:** Blade Gauge Assembly, Socket Wrench, Edge Fence (Guide Rule).

**KP0800XK** 82mm 

**Power Planer**



**Angle and shape of handle are easy to grip, push and carry**

- Built-Precise planing depth setting by adjustment knob with click stops.
- Deep planing.

 **411mm**

<b>Continuous rating Input</b>	620W
<b>Planing width</b>	82mm (3-1/4")
<b>Planing depth</b>	2.5mm (3/32")
<b>No load speed (rpm)</b>	17,000
<b>Dimensions (L x W x H)</b>	285 x 158 x 158mm (11-1/4" x 6-1/4" x 6-1/4")
<b>Net weight</b>	2.6kg (5.7lbs)
<b>Power supply cord</b>	2.5m (8.2ft)
<b>Shiplapping</b>	9mm (11/32")

**Standard Equipment:** Blade Gauge Assembly, Guide Rule, Planer Blade, Socket Wrench

**KP0810K** 82mm 

**Power Planer**



**Lightweight design for easy handling**

- Chip ejection switchable to either side depending on conditions.
- Ergonomically designed handle with rubberized grip provides more control and comfort.
- Front base with 3 chamfering grooves.
- Foot on base protects blades if accidentally put down on surface while blades are still rotating.
- Precise depth adjustment knob.

 **132mm**

<b>Continuous rating Input</b>	850W
<b>Planing width</b>	82mm (3-1/4")
<b>Planing depth</b>	4mm (5/32")
<b>No load speed</b>	16,000rpm
<b>Dimensions (L x W x H)</b>	290 x 168 x 176mm (11-3/8" x 6-5/8" x 6-15/16")
<b>Net weight</b>	3.3kg (7.3lbs)
<b>Power supply cord</b>	2.5m (8.2ft)
<b>Shiplapping</b>	25mm (1")

**Standard Equipment:** Blade Gauge Assembly, Guide Rule, Planer Blade, Socket Wrench

**1911B** 110mm (4-3/8") 

**Power Planer**



**Planes up to 110mm (8/3-4") wide and 2mm (16/1") deep in a single pass**

- Powerful 840W motor in compact and lightweight body (4.2kg /9.3lbs).

 **106mm**

<b>Continuous rating Input</b>	840W
<b>Planing width</b>	110mm (4-3/8")
<b>Planing depth</b>	2mm (1/16")
<b>No load speed</b>	16,000rpm
<b>Overall length</b>	355mm (14")
<b>Net weight</b>	4.3kg (9.5lbs)
<b>Power supply cord</b>	5.0m (16.4ft)



**Standard Equipment:** Blade Gauge Assembly, Guide Rule, Planer Blade, Socket Wrench

- DRILLING / FIXING
- CONCRETE DRILLING / DEMOLITION
- MIXING / STIRRING
- CUTTING (CONCRETE / METAL)
- GRINDING
- SANDING / POLISHING
- SAWING
- MULTI-TOOL
- ROUTERS / PLANERS
- NAILERS / STAPLERS
- HEAT GUN / LASER
- CLEANING
- OPE
- JOBSITE TOOLS
- SPECIALTY TOOLS
- HAND TOOLS / COMBINATION SET
- TOOL HOLDERS AND POUCHES / MAKPAC SYSTEM

- DRILLING / FIXING
- CONCRETE DRILLING / DEMOLITION
- MIXING / STIRRING
- CUTTING (CONCRETE / METAL)
- GRINDING
- SANDING / POLISHING
- SAWING
- MULTI-TOOL

**2012NB 304mm** AC

**Planer / Thicknesser**

**Compact and lightweight for easier transport**

- Unique feeding mechanism assures smoother finish with minimal snip on stock
- 4-post design and diagonal cross supports for stability



<b>Continuous rating Input</b>	1,650W
<b>Cutting width</b>	304mm (12")
<b>Cutting depth</b>	Cutting width 0-150 mm : 3mm (1/8") Cutting width 150-240 mm : 1.5mm (1/16")
<b>Feed rate/min.</b>	8.5m (27.9ft)
<b>Table size (W x L)</b>	304 x 771mm (12" x 30-3/8")
<b>No load speed</b>	8,500rpm
<b>Overall dimensions (L x H x W)</b>	483mm x 771mm x 401mm (19" x 30-3/8" x 15-13/16")
<b>Net weight</b>	28.1kg (61.9lbs)
<b>Power supply cord</b>	2.5m (8.2ft)

**Standard Equipment:** Socket Wrench, Hex Wrench

ROUTERS / PLANERS

- NAILERS / STAPLERS
- HEAT GUN / LASER
- CLEANING
- OPE
- JOBSITE TOOLS
- SPECIALTY TOOLS
- HAND TOOLS / COMBINATION SET
- TOOL HOLDERS AND POUCHES / MAKPAC SYSTEM

**DPJ180** 18V | LXT

**Cordless Plate joiner**



**Provides up to 300 cuts or 150 joints on a single charge of BL1830.**

- Rack-and-pinion vertical fence system engineered for accurate fence adjustments
- Cast aluminum pivot fence with three positive stops at 0°, 45° and 90°, and easy centering on 20mm material
- Six depth settings with one-touch stops for #0, #10, and #20 and most common biscuits sizes
- Can use the same accessories and attachments as AC model PJ7000



<b>Planing width</b>	100 mm (4")
<b>Planing depth</b>	20 mm (3/4")
<b>No load speed (rpm)</b>	6,500
<b>Dimensions (L x W x H)</b>	351x139x149 mm
<b>Net weight</b>	3.1 kg

**Standard Equipment:** Angle Guide, Lock Nut Wrench, Set Plate, Dust Bag

**AVAILABLE VARIANTS**

**"Z" VARIANT**

**DPJ180 Z**  
TOOL ONLY  
(DOES NOT INCLUDE BATTERY / CHARGER OR CARRY CASE)

**Plate Joiner**



**PJ7000** AC

**Plate Joiner**



**Compact and lightweight design for high maneuverability and easy handling**

- New design with cast aluminum parts in silver and slim motor housing with an extra-ergonomic barrel grip.
- New top handle with flat shape on side surface for excellent tool control.



<b>Continuous rating Input</b>	701W
<b>Blade diameter</b>	100mm (4")
<b>No load speed (rpm)</b>	11,000
<b>Dimensions (L x W x H)</b>	302x139x145mm (11-7/8"x5-1/2"x5-3/4")
<b>Net weight</b>	2.5kg (5.6lbs)
<b>Power supply cord</b>	2.5m (8.2ft)

**Standard Equipment:** Angle Guide, Dust Bag, Set Plate, Lock Nut Wrench

## Trimmer and Router



### RT001G

40V MAX | XGT

#### Cordless Trimmer



#### BL motor deliver the same or higher power than that of 1,000W class AC models

- Compatible with the bases used for DRT50 and RT0202C
- Soft Brake - The gentle stop of the product reduces the damage to the work material due to the reaction of the stop
- Push button switch
- Variable speed control by dial
- Compatible with AWS dust extractors wirelessly



Collet Capacity	6, 8 mm or 1/4 - 3/8"
No Load Speed (RPM)	10,000 - 31,000
Plunge Capacity	w/ Trimmer Base: 0 - 40 mm w/ Plunge Base: 0 - 35 mm
Dimensions (L x W x H)	124 x 89 x 197 mm
Net weight*	1.5 kg (without battery)

**Standard Equipment:** Trimmer Base Assembly, Straight Guide Assembly

#### AVAILABLE VARIANTS

4.0Ah	"Z" VARIANT
<b>RT001G M2</b> INCLUDES 2 BATTERIES / 1 CHARGER / / MAKPAC CONNECTOR CASE	<b>RT001G Z</b> TOOL ONLY (DOES NOT INCLUDE BATTERY / CHARGER / / CARRYING CASE)

DRILLING / FIXING

CONCRETE DRILLING / DEMOLITION

MIXING / STIRRING

CUTTING (CONCRETE / METAL)

GRINDING

SANDING / POLISHING

SAWING

MULTI-TOOL

ROUTERS / PLANERS

### DRT50

18V | LXT

#### Cordless Trimmer



#### Cordless for easy maneuverability and 4 different bases for added versatility

- Aluminum base for higher durability and accuracy
- Dual LED job lights illuminate cutting edge and increase visibility
- Connectable to Makita Vacuum Cleaner with dust nozzle for a cleaner work environment
- Can use the same accessories and attachments as model RT001G & RT0700C



No Load Speed (RPM)	10,000 - 30,000
Plunge Capacity	with Trimmer Base: 0 - 40 mm with Plunge Base: 0 - 35 mm
Dimensions (L x W x H)	134x89x226 mm
Net weight	2.1 kg

**Standard Equipment :** Collet Cone, Trimmer Base Assembly, Straight Guide Assembly, Templet Guide, Wrench x2, Trimmer Guide

#### AVAILABLE VARIANTS

#### "Z" VARIANT

**DRT50 Z**  
TOOL ONLY  
(DOES NOT INCLUDE BATTERY / CHARGER OR CARRY CASE )

### RT0702C 6mm (1/4"), 8mm (3/8")



#### Trimmer

#### Anti-Restart Function



#### Aluminum housing and base for higher durability and accuracy

- Able to meet a wide range of needs with the motor unit and the following various attachments (Trimmer base, Plunge base, Tilt base, Offset base).
- Flat-top design and Horizontally installed power supply cord provides stability for easier bit change.
- Cutting speed is variably adjustable to suit applications and workpiece materials.



Continuous rating Input	710W
Collet Capacity	6, 8 mm or 1/4, 3/8"
No Load Speed (RPM)	10,000 - 34,000
Dimensions (L x W x H)	89 x 89 x 210 mm (3-1/2 x 3-1/2 x 8-1/4")
Net weight	1.8 - 2.8 kg (4.0 - 6.2 lbs.)

NAILERS / STAPLERS

HEAT GUN / LASER

CLEANING

OPE

JBSITE TOOLS

SPECIALTY TOOLS

HAND TOOLS / COMBINATION SET

TOOL HOLDERS AND POUCHES / MAKPAC SYSTEM

- DRILLING / FIXING
- CONCRETE DRILLING / DEMOLITION
- MIXING / STIRRING
- CUTTING (CONCRETE / METAL)
- GRINDING
- SANDING / POLISHING
- SAWING
- MULTI-TOOL

**RT0700C** 6mm (1/4"), 8mm (3/8") AC

**Trimmer**



**Aluminum housing and base for higher durability and accuracy**

- Able to meet a wide range of needs with the motor unit and the following various attachments (Trimmer base, Plunge base, Tilt base, Offset base).
- Flat-top design and Horizontally installed power supply cord provides stability for easier bit change.
- Cutting speed is variably adjustable to suit applications and workpiece materials.





<b>Continuous rating Input</b>	710W
<b>Capacity</b>	Collet : 6mm, 8mm or 1/4", 3/8"
<b>No load speed (rpm)</b>	10,000 - 30,000
<b>Dimensions (L x W x H)</b>	89x89x200mm (3-1/2" x3-1/2" x7-7/8")
<b>Net Weight</b>	1.8kg (3.9lbs)
<b>Power supply cord</b>	2.5m (8.2ft)

**Standard Equipment:** Trimmer Base Assembly, Straight Guide, Wrench (2 pcs)

- ROUTERS / PLANERS

**3709** 6mm (1/4") AC

**Trimmer**

**Smooth and precision depth adjustment with rackand pinion mechanism**

- Rubberized soft grip provides comfort and control
- Transparent plastic base for clear view of trimming edge



<b>Continuous rating Input</b>	530W
<b>Capacity</b>	Collet : 6mm or 1/4"
<b>No load speed (rpm)</b>	30,000
<b>Dimensions (L x W x H)</b>	82x90x199mm (3-1/4" x3-1/2" x7-7/8")
<b>Net weight</b>	1.5kg (3.3lbs)
<b>Power supply cord</b>	2.5m (8.2ft)

**Standard Equipment:** Trimmer Guide Assembly, Straight Guide Assembly, Template Guide, Wrenches 2

- NAILERS / STAPLERS
- HEAT GUN / LASER
- CLEANING
- OPE
- JOBSITE TOOLS
- SPECIALTY TOOLS
- HAND TOOLS / COMBINATION SET
- TOOL HOLDERS AND POUCHES / MAKPAC SYSTEM

**RP0900** 6mm (1/4") AC

**Router (Plunge type)**



**High durability and good design router**

- 0-35mm(0-1/8") plunge depth capacity with 3 adjustable depth stops for repetitive depth routing
- Scale level for adjusting the depth of routing





<b>Continuous rating Input</b>	900W
<b>Capacity</b>	Collet : 8mm or 3/8"
<b>Base</b>	145 x 110mm (5-3/4" x 4-5/16")
<b>No load speed (rpm)</b>	27,000
<b>Dimensions (L x W x H)</b>	256 x 110 x 217mm (10-3/32" x 4-5/16" x 8-17/32")
<b>Net weight</b>	2.7kg (6.0lbs)
<b>Power supply cord</b>	2.5m (8.2ft)

**Standard Equipment:** Straight Guide, Wrenches

**3601B** 12mm (1/2") AC

**Router**

**Fine power-to-weight ratio in this well-balanced router**

- Non-marring base for excellent finish



<b>Continuous rating Input</b>	930W
<b>Capacity</b>	Collet : 12mm or 1/2"
<b>Base dia.</b>	160mm (6-1/4")
<b>No load speed</b>	23,000rpm
<b>Overall height</b>	190mm (7-1/2")
<b>Net weight</b>	3.6kg (7.9lbs)
<b>Power supply cord</b>	5.0m (16.4ft)

**Standard Equipment:** Trimmer Guide Assembly, Straight Guide Assembly, Template Guide, Wrenches 2



**3612BR** 12mm (1/2")

**Router (Plunge type)**



**Faster, more accurate, more powerful routing**

- Large plunge capacity 0-65mm for easy penetration into or through workpiece



<b>Continuous rating Input</b>	1,600W
<b>Capacity</b>	Collet : 12mm or 1/2"
<b>Plunge capacity</b>	0 - 65mm (0 - 2-9/16")
<b>Base dia.</b>	160mm (6-1/4")
<b>No load speed</b>	23,000rpm
<b>Overall height</b>	287mm (11-1/4")
<b>Net weight</b>	5.5kg (12.0lbs)
<b>Power supply cord</b>	2.5m (8.2ft)

**Standard Equipment:** Trimmer guide, Straight guide, Template guide, Guide holder, Collet sleeve (6mm or 1/4"), Collet sleeve (8mm or 3/8"), Wrench x2, Straight bit (carbide-tipped)

**RP1800** 12mm (1/2")

**Router (Plunge type)**



**Powerful motor delivers smooth routing**

- Precise cutting depth adjustment.
- Ergonomically contoured knob style handles fit operator's hands perfectly.
- Linear ball bearing for super-smooth plunge action.
- Increased durability obtained by using larger size ball bearing on the drive-end of armature, labyrinth type retainers and fun



<b>Continuous rating Input</b>	1,850W
<b>Capacity</b>	Collet : 12mm or 1/2"
<b>Plunge capacity</b>	0 - 70mm (0 - 2-3/4")
<b>Base dia.</b>	170mm (6-11/16")
<b>No load speed (rpm)</b>	22,000
<b>Dimensions (L x W x H)</b>	155 x 294 x 312mm (6-1/8" x 11-5/8" x 12-1/4")
<b>Net weight</b>	6.0kg (13.2lbs)
<b>Power supply cord</b>	2.5m (8.2ft)

**Standard Equipment:** Straight Guide, Wrench, Screw M6x135

**RP2300FC** 12mm (1/2")



**Router (Plunge type)**



**Powerful motor delivers smooth routing**

- Precise cutting depth adjustment.
- Ergonomically contoured knob style handles fit operator's hands perfectly.
- Twin LED job lights with afterglow function.
- Linear ball bearing for super-smooth plunge action.
- Increased durability obtained by using larger size ball bearing on the drive-end of armature, labyrinth type retainers and fun.



<b>Continuous rating Input</b>	220V: 2,300W / 127V: 1,650W
<b>Capacity</b>	Collet : 12mm or 1/2"
<b>Plunge capacity</b>	0 - 70mm (0 - 2-3/4")
<b>Base</b>	170 x 155mm (6-11/16" x 6-1/8")
<b>No load speed (rpm)</b>	9,000 - 22,000
<b>Dimensions (L x W x H)</b>	155 x 294 x 312mm (6-1/8" x 11-5/8" x 12-1/4")
<b>Net weight</b>	6.1kg (13.4lbs)
<b>Power supply cord</b>	2.5m (8.2ft)

**Standard Equipment:** Straight Guide, Wrench, Screw M6 x 135

**4403** 6mm (1/4")



**Sash Router**



**Mills and drills aluminium for sashes.**

- Trimmer model 3709 used as motor unit.
- Large transparent chip guard for operator's safety.
- Base travels side to side.
- Base travels forward and backward.



<b>Continuous rating Input</b>	530W
<b>Capacity</b>	Collet : 6mm or 1/4"
<b>Max. width of work</b>	123mm (4-7/8")
<b>Max. width at 45 degrees</b>	77mm (3")
<b>Max. height of work</b>	185mm (7-1/4")
<b>Base transv. travel</b>	113mm (4-1/2")
<b>Base longit. travel</b>	73mm (2-7/8")
<b>No load speed</b>	30,000rpm
<b>Overall dimensions (L x H x W)</b>	327mm x 350mm x 355mm (12-7/8" x 13-13/16" x 14")
<b>Net weight</b>	16.0kg (35.3lbs)
<b>Power supply cord</b>	2.5m (8.2ft)

**Standard Equipment:** Angle Gauge, Wrenches 2,

DRILLING / FIXING

CONCRETE DRILLING / DEMOLITION

MIXING / STIRRING

CUTTING (CONCRETE / METAL)

GRINDING

SANDING / POLISHING

SAWING

MULTI-TOOL

ROUTERS / PLANERS

NAILERS / STAPLERS

HEAT GUN / LASER

CLEANING

OPE

JOBSITE TOOLS

SPECIALTY TOOLS

HAND TOOLS / COMBINATION SET

TOOL HOLDERS AND POUCHES / MAKPAC SYSTEM

# Router Bits

## Standard Range (blister pack)



### Straight bit 1 flute



Shank dia. mm	Overall dia. mm	Length mm	Carbide Height mm	Part No.
6	6	50.8	19	D-67701

### Flush trim bit 3 flutes



Shank dia. mm	Overall dia. mm	Length mm	Carbide Height mm	Part No.
12	12.7	91.2	38	D-68052

### Straight bit 2 flutes



Shank dia. mm	Overall dia. mm	Length mm	Carbide Height mm	Part No.
6	6	48	16	D-67717
6	6	57	25	D-67723
6	8	51	19	D-67739
6	8	57.1	25.4	D-67745
6	10	57.4	25.4	D-67751
6	12	64	32	D-67767
6	20	50.8	19	D-67789
8	8	51	19	D-67810
12	10	69.8	25.4	D-67913
12	12	73	32	D-67929

### V groove bit



Shank dia. mm	Overall dia. mm	Length mm	Carbide Height mm	Angle (°)	Part No.
6	12.7	44.7	12.7	90	D-68155
6	19	47.7	16	90	D-68177
8	12.7	44.7	12.7	90	D-68183

### Chamfer bit



Shank dia. mm	Overall dia. mm	Length mm	Carbide Height mm	Angle (°)	Part No.
8	30.2	54.7	12.7	45	D-68719

### Flush trim bit 2 flutes



Shank dia. mm	Overall dia. mm	Length mm	Carbide Height mm	Part No.
6	9.5	66.9	26	D-67985
8	12.7	55.5	13	D-68024
8	12.7	68.5	26	D-68030

### Core box bit - 2 flutes



Shank dia. mm	Overall dia. mm	Length mm	Carbide Height mm	Radius 1 (R)	Part No.
8	12.7	41.3	10	6.35	D-68292

## Router Bits Standard Range (boxed pack)



- Standard Range of router bits
- The bits come in a compact and attractive case which can be label space beautifully displayed on the display stands

### Straight Bit (1 Flute)

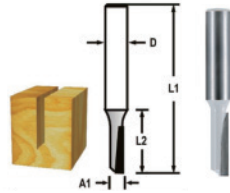

A1	L2	L1	D	Flutes	Part No.
3	13	51	8	1	D-47379
4	13	51	8	1	D-47385
6	19	50.8	8	1	D-47400
6	19	50.8	6	1	D-47416

### Straight Bit (2 Flute)

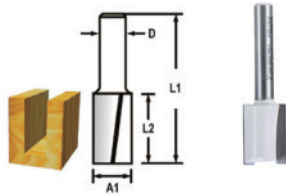

A1	L2	L1	D	Flutes	Part No.
6	16	48	6	2	D-47422
6	25	57	6	2	D-47438
8	19	51	6	2	D-47444
8	25.4	57.4	6	2	D-47450
10	25.4	57.4	6	2	D-47466
14	19.1	51	6	2	D-47488
6	16	48	8	2	D-47503
6	19	51	8	2	D-47519
8	19.1	51	8	2	D-47525
10	19.1	51	8	2	D-47531
20	19.1	51	8	2	D-47581
22	25.4	57.4	8	2	D-47597
24	25.4	57	8	2	D-47606
10	25.4	70	12	2	D-47628
18	32	73	12	2	D-47662
25	32	73	12	2	D-47684

### Flush Trim Bit

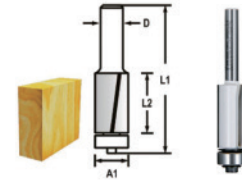

A1	L2	L1	D	Bearing size (mm)	Flutes	Part No.
9.5	26	66.9	6	9.5	2	D-47690
12.7	13	56	6	12.7	2	D-47709
12.7	26	68.5	6	12.7	2	D-47715
9.5	26	67	8	9.5	2	D-47721
12.7	13	55.7	8	12.7	2	D-47737

### V Groove Bit

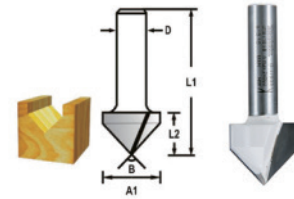

A1	L2	L1	B	D	Flutes	Part No.
12.7	12.7	44.7	90°	6	2	D-47868
12.7	16	48	60°	6	2	D-47874
19	16	47.6	90°	6	2	D-47880
12.7	12.7	44.7	90°	8	2	D-47896
15.9	12.7	44	90°	8	2	D-47905
12.7	12.7	54	90°	12	2	D-47911
15.9	12.7	50.8	90°	12	2	D-47927
19.05	16	47.6	90°	8	2	D-47933
19.05	16	57.3	90°	12	2	D-47949
28.6	22.2	60.3	90°	12	2	D-47955
12.7	16	48	60°	8	2	D-47961

### Round Nose Bit

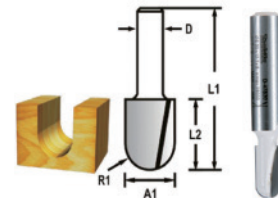

A1	L2	L1	R1	D	Flutes	Part No.
6.35	12.7	44.5	3.2	6	2	D-47802
9.5	12.7	44.5	4.8	6	2	D-47818
6.35	12.7	44.5	3.2	8	2	D-47830
9.5	12.7	44.5	4.8	8	2	D-47846

DRILLING / FIXING

CONCRETE DRILLING / DEMOLITION

MIXING / STIRRING

CUTTING (CONCRETE / METAL)

GRINDING

SANDING / POLISHING

SAWING

MULTI-TOOL

ROUTERS / PLANERS

NAILERS / STAPLERS

HEAT GUN / LASER

CLEANING

OPE

JOB SITE TOOLS

SPECIALTY TOOLS

HAND TOOLS / COMBINATION SET

TOOL HOLDERS AND POUCHES / MAKPAC SYSTEM

DRILLING /  
FIXING

## Router Bits (Standard Range)

CONCRETE  
DRILLING /  
DEMOLITION

MIXING /  
STIRRING

CUTTING  
(CONCRETE /  
METAL)

GRINDING

SANDING /  
POLISHING

SAWING

MULTI-TOOL

ROUTERS /  
PLANERS

NAILERS /  
STAPLERS

HEAT GUN /  
LASER

CLEANING

OPE

JOBSITE  
TOOLS

SPECIALTY  
TOOLS

HAND TOOLS /  
COMBINATION SET

TOOL HOLDERS  
AND POUCHES /  
MAKPAC SYSTEM

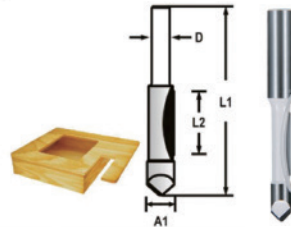

### Panel Pilot Bit

A1	L2	L1	D	Flutes	Part No.
6.35	19	65	6	1	D-47771
6.35	19	65	8	1	D-47787
9.5	26	75	12	1	D-47793

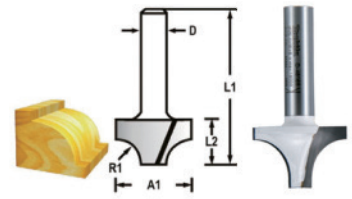

### Ovolo Bit

A1	L2	L1	R1	D	Flutes	Part No.
19	9.5	42.5	3.2	6	2	D-48278
25.4	13.5	45.5	6.35	6	2	D-48284

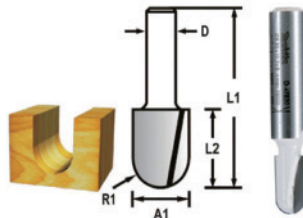

### Core Box Bit

A1	L2	L1	R1	D	Flutes	Part No.
6.35	6.35	38.3	3.2	8	2	D-47977
12.7	10	41.5	6.35	8	2	D-48000

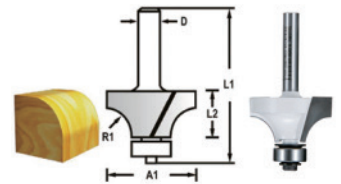

### Roundover Bit with Bearing

A1	L2	L1	R1	D	Bearing size (mm)	Flutes	Part No.
20.6	10	58.6	4	6	12.7	2	D-48309
25.4	13.5	56.5	6.35	6	12.7	2	D-48315
28.6	14.5	57.3	7.9	6	12.7	2	D-48321
17.3	8	51	2.3	8	12.7	2	D-48343
20.7	10	52.3	4	8	12.7	2	D-48365
2.2	12.7	55	4.8	8	12.7	2	D-48371
25.4	13.5	56.5	6.35	8	12.7	2	D-48387
28.6	14.5	57.3	7.9	8	12.7	2	D-48393

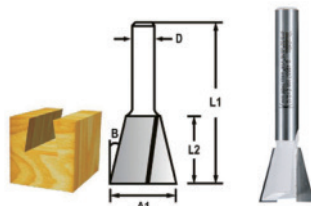

### Dovetail Bit

A1	L2	L1	B	D	Flutes	Part No.
6.35	8	63.5	7.5°	8	2	D-48050

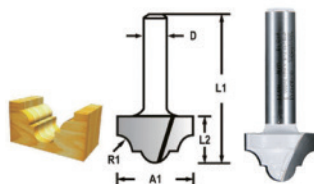

### Classic Plunge Cut Bit

A1	L2	L1	R1	D	Flutes	Part No.
12.7	10	42	2.4	8	2	D-48206
25.4	16	54	5.6	12	2	D-48228

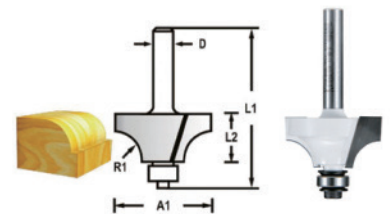

### Beading Bit with Bearing

A1	L2	L1	R1	D	Bearing size (mm)	Flutes	Part No.
20.3	10	50.5	4	6	9.5	2	D-48452
22.2	12.7	53.2	4.8	6	9.5	2	D-48468
28.6	14.5	55.5	7.9	6	9.5	2	D-48474
20.7	10	50.5	4	8	9.5	2	D-48505

## Router Bits (Standard Range)

### Chamfer Bit with Bearing

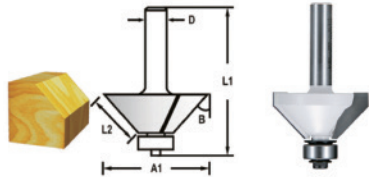

A1	L2	L1	B	D	Bearing size (mm)	Flutes	Part No.
26	11	51	45°	6	12.7	2	D-48658

### Reversible Glue Joint Bit (Straight Profile)

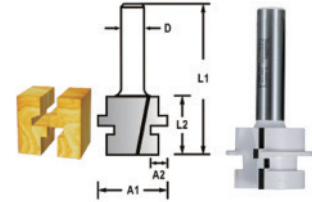

A1	A2	L1	L2	D	Bearing size (mm)	Flutes	Part No.
30.1	6.35	57.2	25.4	8	-	2	D-48913
41.3	7.9	76.2	25.4	12	-	2	D-48929

### Roman Ogee Bit with Bearing

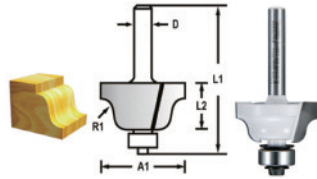

A1	L2	L1	R1	D	Bearing size (mm)	Flutes	Part No.
25.4	9.5	52.5	3.2	6	12.7	2	D-48804
38.1	17.5	60	6.35	8	12.7	2	D-48767

### Tongue & Groove Assembly

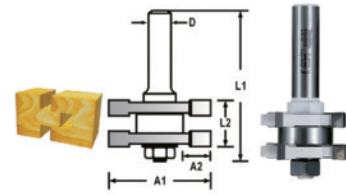

A1	A2	L1	L2	D	Bearing size (mm)	Flutes	Part No.
41	8.5	71	19	12	24	4	D-48935

### Ogee Bit with Bearing

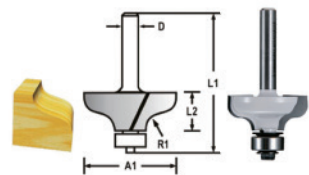

A1	L2	L1	R1	D	Bearing size (mm)	Flutes	Part No.
31.8	12.7	55.6	4.8	8	12.7	2	D-48773

### Slotting Cutter (3 Wing Slot Cutter)

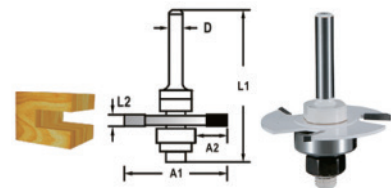

A1	A2	L1	L2	D	Bearing size (mm)	Flutes	Part No.
47.6	12.7	59	2	8	22.2	3	D-48941
47.6	12.7	59	4	8	22.2	3	D-48979

### Keyhole Bit

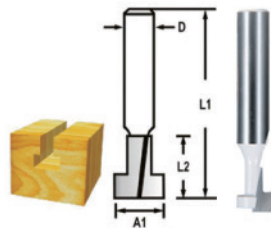

A1	L2	L1	D	Flutes	Part No.
9.5	10.5	48	8	2	D-48907

### Slatwall Router Bit



It is used to prepare the groove for hooks to be used for exhibitions, indoor decorations, showrooms, etc. This will enhance our range of router bit

Dia (mm)	Length (mm)	Overall length	Shank (mm)	Flutes	Part No.
38	17.5	55.5	12	2	D-61852

DRILLING / FIXING

CONCRETE DRILLING / DEMOLITION

MIXING / STIRRING

CUTTING (CONCRETE / METAL)

GRINDING

SANDING / POLISHING

SAWING

MULTI-TOOL

ROUTERS / PLANERS

NAILERS / STAPLERS

HEAT GUN / LASER

CLEANING

OPE

JOB SITE TOOLS

SPECIALTY TOOLS

HAND TOOLS / COMBINATION SET

TOOL HOLDERS AND POUCHES / MAKUPAC SYSTEM

# Router Bits

## Straight Bit

DRILLING / FIXING

CONCRETE DRILLING / DEMOLITION

MIXING / STIRRING

CUTTING (CONCRETE / METAL)

GRINDING

SANDING / POLISHING

SAWING

MULTI-TOOL

ROUTERS / PLANERS

NAILERS / STAPLERS

HEAT GUN / LASER

CLEANING

OPE

JOBSITE TOOLS

SPECIALTY TOOLS

HAND TOOLS / COMBINATION SET

TOOL HOLDERS AND POUCHES / MAKPAC SYSTEM

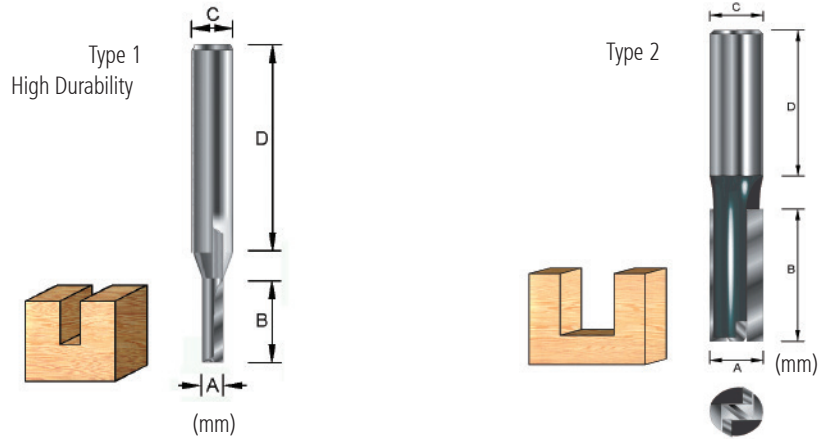

A	B	C	D	Type	Part No.
2	8.0	6	32	1	D-12114
3	8.0	6	32	1	D-12120
3	12.0	6	32	1	D-12136
3.18	12.7	6	32	1	D-12142
3.97	12.7	6	32	1	D-12158
4	12.0	6	32	1	D-12164
4.76	15.9	6	32	1	D-12170
5	20.0	6	32	1	D-12186
6	20.0	6	32	1	D-12192
20	20.0	6	32	1	D-13742
3	15.9	6	32	2	D-13409
6	16.0	6	32	2	D-13415
6	25.4	6	32	2	D-13502
6	16.0	6	32	2	D-13627
6	16.0	6	32	2	D-08816
6	18.0	6	30	2	D-13910
6	19.0	6	32	2	D-13633
6	25.4	6	32	2	D-13649
6.35	25.4	6	32	1	D-12201
8	18.0	6	32.5	2	D-13926
8	20.0	6	32	2	D-13655
8	25.0	6	32	2	D-13661
8	25.0	6	32	2	D-13518
10	25.0	6	32	2	D-13677
12	25.4	6	32	2	D-13683
2	6.0	8	32	2	D-12217
8	25.0	8	32	2	D-13948
8	25.0	8	32	2	D-13699
12	38.1	8	32	2	D-13524
12	50.8	8	32	2	D-13530
12	63.5	8	32	2	D-13546
13	20.0	8	32	2	D-13552
13	25.0	8	32	2	D-13568
14	20.0	8	32	2	D-13574
14	31.8	8	32	2	D-13708

A	B	C	D	Type	Part No.
10	25.0	12	38	2	D-13714
10	25.0	12	26	2	D-13895
10	31.8	12	38	2	D-13421
12	20.0	12	38	2	D-13580
12	25.4	12	38	2	D-13437
12	30.0	12	25	2	D-13904
12	31.8	12	38	2	D-13720
12	38.1	12	38	2	D-13596
12	38.1	12	38	2	D-13443
12	50.8	12	38	2	D-13459
12	63.5	12	38	2	D-13465
13	20.0	12	38	2	D-13471
13	25.0	12	38	2	D-13487
14	20.0	12	38	2	D-13493
14	31.8	12	38	2	D-13605
16	31.8	12	38	2	D-13611
25.4	25.4	12	38	2	D-13736
12	30.0	12.7	31	2	D-07901

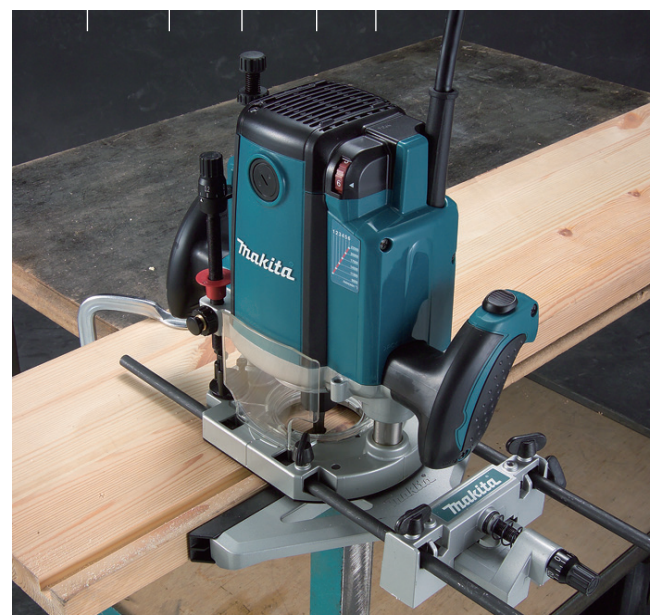

### Drill Point Flush Trimming Bit

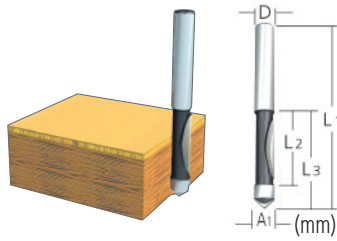

D	A1	L1	L2	L3	Part No.
9.5	8	60	20	35	793107-6
12	12	60	20	35	D-10584

### Panel Pilot Bit

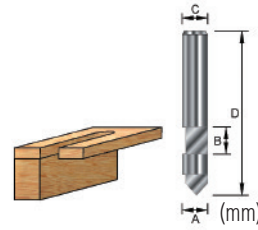

A	B	C	D	Part No.
6	6.35	6	38	D-12348

### Flush Trim Bit

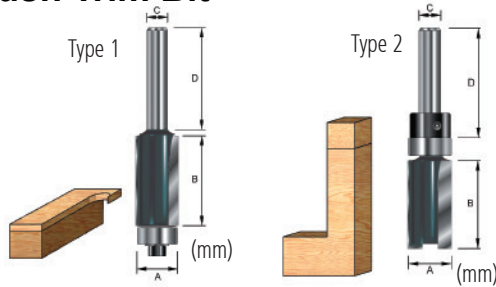

A	B	C	D	Type	Part No.
6.35	19	6	32	1	D-12223
9.5	25.4	6	32	1	D-12239
10	20	6	30	1	D-13932
12.7	25.4	6	32	1	D-12245
9.5	12.7	8	32	1	D-12251
12.7	30.2	8	32	1	D-12267
12.7	50.8	12	38	1	D-10506
12	19	8	32	2	D-12304
12	25	8	32	2	D-12310
28.58	30.16	12	38	2	D-12273
28.58	38.1	12	38	2	D-12289
32	38.1	12	38	2	D-12295

### Drill Point Double Flush Trimming Bit

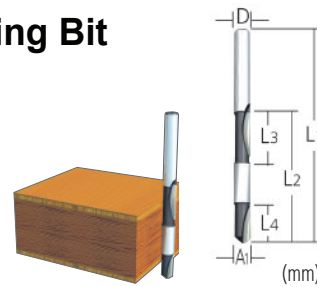

D	A1	L1	L2	L3	L4	Part No.
9.5	8	80	55	20	25	793110-7
12	12	85	60	24	22.5	793127-0

### Bevel Trim Bit

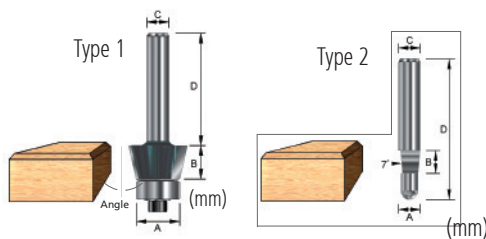

A	B	C	D	Angle	Type	Part No.
6	6.35	6	38	7°	2	D-12332
14.5	9.5	6	32	7°	1	D-12326
19.9	9.5	8	32	22°	1	D-10615

### “V” Groove Bit

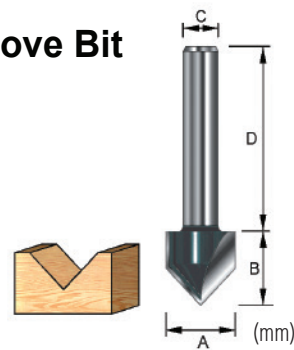

A	B	C	D	Angle	Part No.	Part No.
9.5	9.5	6	32	90°	-	D-12360
12.7	11.11	6	32	90°	-	D-12376
12.7	12.7	6	32	90°	-	D-12398
19.05	15.9	6	32	90°	-	D-12407
20	15	6.35	32	90°	793194-5	-
9.5	9.5	8	32	90°	-	D-12382
9.5	9.5	12	38	90°	-	D-12354

- DRILLING / FIXING
- CONCRETE DRILLING / DEMOLITION
- MIXING / STIRRING
- CUTTING (CONCRETE / METAL)
- GRINDING
- SANDING / POLISHING
- SAWING
- MULTI-TOOL
- ROUTERS / PLANERS
- NAILERS / STAPLERS
- HEAT GUN / LASER
- CLEANING
- OPE
- JOB SITE TOOLS
- SPECIALTY TOOLS
- HAND TOOLS / COMBINATION SET
- TOOL HOLDERS AND POUCHES / MAKPAC SYSTEM

DRILLING / FIXING

CONCRETE DRILLING / DEMOLITION

MIXING / STIRRING

CUTTING (CONCRETE / METAL)

GRINDING

SANDING / POLISHING

SAWING

MULTI-TOOL

ROUTERS / PLANERS

NAILERS / STAPLERS

HEAT GUN / LASER

CLEANING

OPE

JOBSITE TOOLS

SPECIALTY TOOLS

HAND TOOLS / COMBINATION SET

TOOL HOLDERS AND POUCHES / MAKAPAC SYSTEM

### “U” Groove Bit

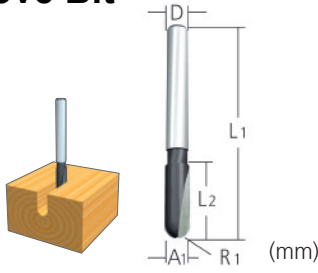

D	A1	L1	L2	R1	Part No.	Part No.
6	6	50	18	3	793328-0	D-09329
6.35	6	50	18	3	793329-8	-
12.7	12	55	20	6	793100-0	-

### Core Box Bit

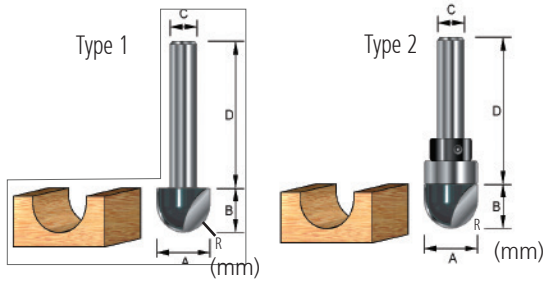

A	B	C	D	R	Type	Part No.
6	6	6	32	3	1	D-12441
12.7	12.7	6	38	-	2	D-12550
12	9.5	8	32	6	1	D-10805
20	16	8	32	10	1	D-12457
12.7	9.5	12	38	6.35	1	D-12429
15.9	12.7	12	38	7.94	1	D-12435

### Ball Groove Bit

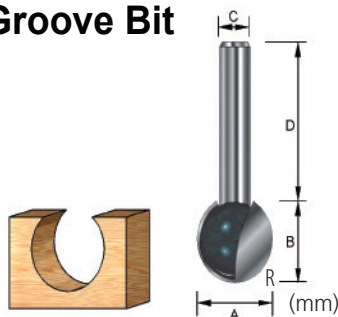

A	B	C	D	R	Part No.
15.9	15.9	6	32	11.11	D-12463

### Beading Bit

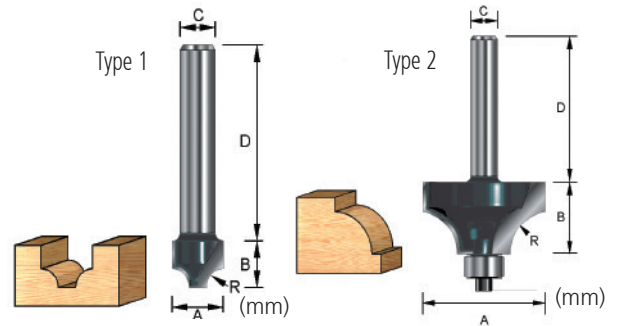

A	B	C	D	R	Type	Part No.
12.7	11.11	6	32	4.76	1	D-12479
19	9.5	6	32	3.18	2	D-12706
20.7	9.5	6	32	4	2	D-12712
22.2	9.5	6	32	4.76	2	D-12728
24.7	12.7	6	32	6	2	D-12734
25.4	11.11	6	32	6.35	2	D-12740
28.6	12.7	6	32	8	2	D-12756
31.8	15.9	6	32	9.52	2	D-12762
32.7	16	8	32	10	2	D-13823
38.1	19	8	32	12.7	2	D-11368
30	20	12	35	4	2	793071-1
32.7	16	12	38	10	2	D-12681
36.7	19	12	38	12	2	D-13839
50.8	25.4	12	38	19.05	2	D-11374
88.9	44.45	12	45	38.1	2	D-12697

### Cove Beading Bit

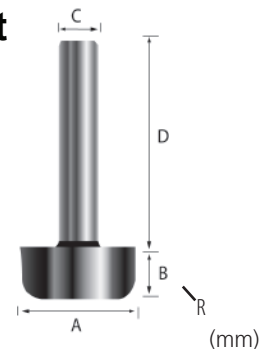

A	B	C	D	R	Part No.
20	8	6	39	4R	793146-6
25	13	6	35	8R	793147-4



### Ball Bearing Cove Beading Bit

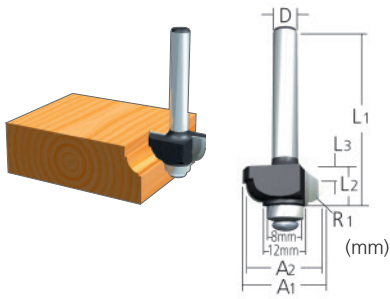

D	A1	A2	L1	L2	L3	R1	Part No.
6	20	18	40	10	5.5	3°	793157-1
6.35	26	22	42	12	5	5°	793175-9

### Classic Panel Bit

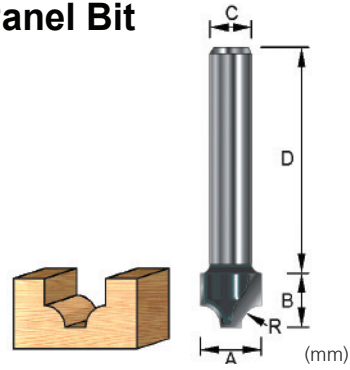

A	B	C	D	R	Part No.
12.7	9.5	6	32	2.38°	D-12522
19.05	12.7	6	32	3.97°	D-12538
12.7	9.5	8	32	2.38°	D-11069
19.05	12.7	8	32	3.97°	D-11075
12.7	9.5	12	38	2.38°	D-12500
19.05	12.7	12	38	3.97°	D-12516
38.1	22.2	12	38	8.73°	D-11097

### Dovetail Bit

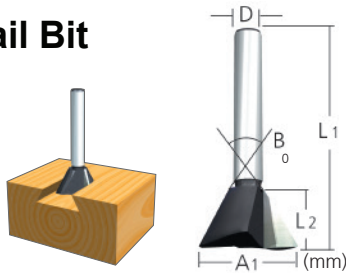

D	A1	L1	L2	B <sub>0</sub>	Part No.
6.35	14.5	55	10	35°	793373-5

### Ogee Bit

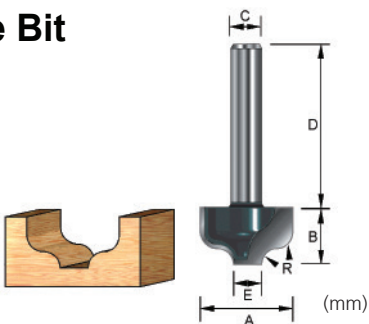

A	B	C	D	E	R	Part No.
12.7	9.5	6	32	4.76	1.98°	D-12485
19.05	11.11	6	32	6.35	3.18°	D-12491

### Classic Beading Bit

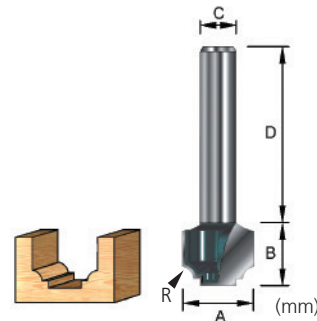

A	B	C	D	R	Part No.
19.05	11.11	12	38	3.18°	D-12544

### Pierce & Round Over Bit (Plunge Cutting)

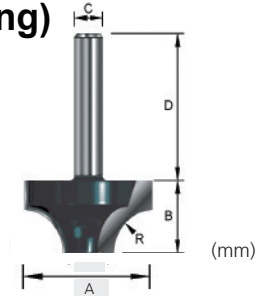

A	B	C	D	R	Part No.
38.1	22.2	8	32	12.7°	D-13889

- DRILLING / FIXING
- CONCRETE DRILLING / DEMOLITION
- MIXING / STIRRING
- CUTTING (CONCRETE / METAL)
- GRINDING
- SANDING / POLISHING
- SAWING
- MULTI-TOOL
- ROUTERS / PLANERS
- NAILERS / STAPLERS
- HEAT GUN / LASER
- CLEANING
- OPE
- JOB SITE TOOLS
- SPECIALTY TOOLS
- HAND TOOLS / COMBINATION SET
- TOOL HOLDERS AND POUCHES / MAKPAC SYSTEM

DRILLING / FIXING

CONCRETE DRILLING / DEMOLITION

MIXING / STIRRING

CUTTING (CONCRETE / METAL)

GRINDING

SANDING / POLISHING

SAWING

MULTI-TOOL

ROUTERS / PLANERS

NAILERS / STAPLERS

HEAT GUN / LASER

CLEANING

OPE

JOBSITE TOOLS

SPECIALTY TOOLS

HAND TOOLS / COMBINATION SET

TOOL HOLDERS AND POUCHES / МАКРАС СИСТЕМ

### Cove & Bead Bit

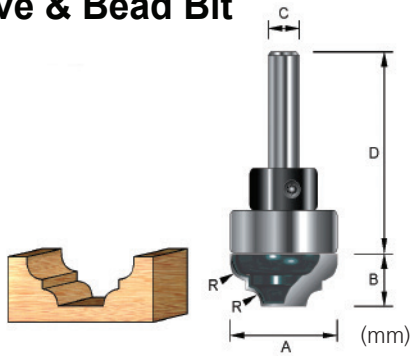

A	B	C	D	R	Part No.
22	9.9	8	40	3.18°	D-11156
35	14.28	12	50	5.56°	D-12566

### Rounding Over Bit

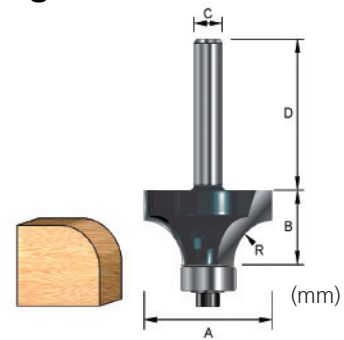

A	B	C	D	R	Part No.
15.9	9.5	6	32	1.59°	D-12603
19	9.5	6	32	3.18°	D-12619
24.7	12.7	6	32	6°	D-12625
25.4	11.11	6	32	6.35°	D-12631
28.6	12.7	6	32	8°	D-12647
31.8	15.9	6	32	9.52°	D-12653
38.1	19	6	32	12.7°	D-12669
20.7	9.5	8	32	4°	D-11209
24.7	12.7	8	32	6°	D-12675
31.8	15.9	8	32	9.52°	D-11243
32.7	16	12	38	10°	D-12588
36.7	19	12	38	12°	D-12594
38.1	19	12	38	12.7°	D-13786
20	10	12.7	40	6°	793104-2

### Classical Plunge Bit

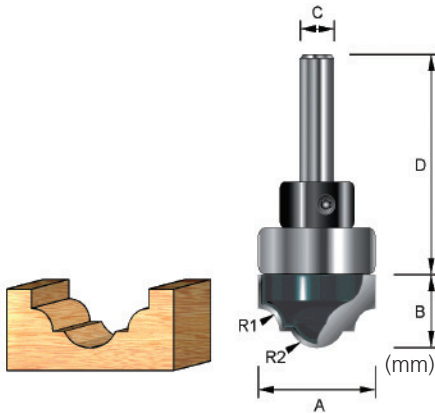

A	B	C	D	R	Part No.
22	12.7	8	40	R1=3.97°, R2=5.55°	D-11178
35	14.28	12	50	R1=6.35°, R2=10.32°	D-12572

### Ball Bearing Corner Rounding Bit

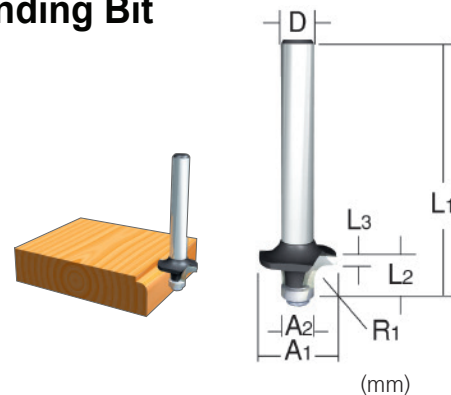

D	A1	A2	L1	L2	L3	R1	Part No.
6	15	8	37	7	3.5	3°	793151-3
6	21	8	40	10	3.5	6°	D-09444
6.35	21	8	40	10	3.5	6°	793169-4

### Classic Mold Bit

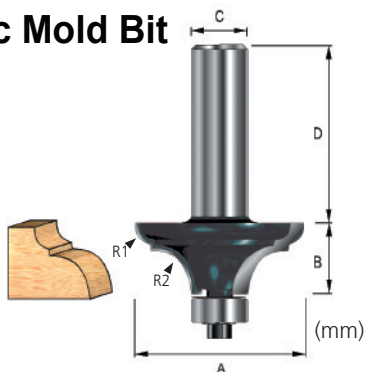

A	B	C	D	R	Part No.
38.1	15.9	8	32	R1=3.18°, R2=9/5°	D-11704
38.1	15.9	12	38	R1=3.18°, R2=9.5°	D-13029

### Slotting Bit

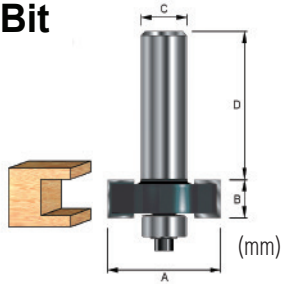

A	B	C	D	Part No.
31.8	3.18	6	32	D-12843
31.8	4.76	6	32	D-12859
31.8	6.35	6	32	D-12865
31.8	7.94	6	32	D-12871
31.8	9.5	6	32	D-12887

### Ogee with Fillet Bit

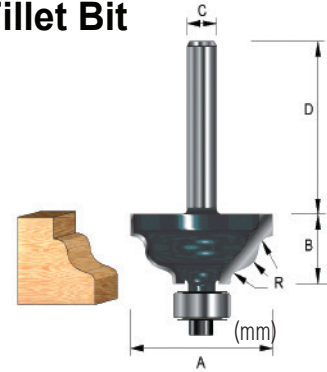

A	B	C	D	R	Part No.
34.9	14.28	8	32	4.76°	D-11586
41.28	17.46	8	32	6.35°	D-11592

### Roman Ogee Bit

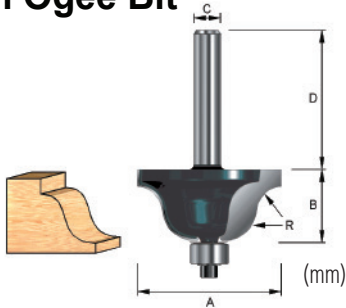

A	B	C	D	R	Part No.
27	11.9	6	32	3.97°	D-12902
34.9	16.6	6	32	6.35°	D-12918
27	11.9	8	32	3.97°	D-11542
34.9	16.6	8	32	6.35°	D-11558
43	25	12	38	8°	D-12893

### Classic Ogee Bit

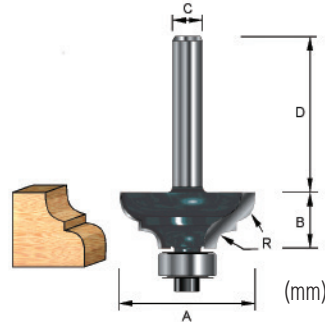

A	B	C	D	R	Part No.
25.4	12.7	6	32	3.18°	D-12946
31.8	14.28	8	32	4.76°	D-11617
38.1	17.46	12	38	6.35°	D-12930

### Ogee Bit

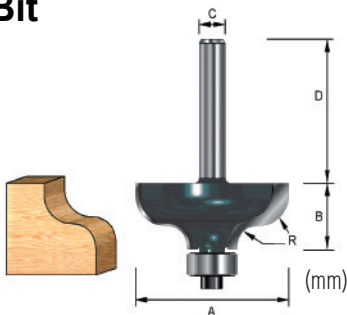

A	B	C	D	R	Part No.
31.8	12.7	8	32	4.76°	D-11564
38.1	17.46	8	32	6.35°	D-11570
38.1	17.46	12	38	6.35°	D-12924

### Classic Roman Ogee Bit

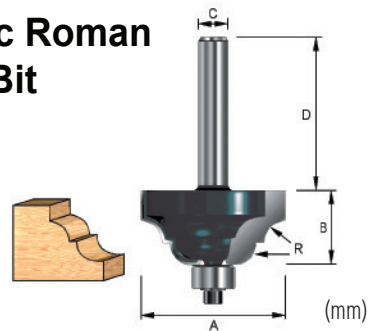

A	B	C	D	R	Part No.
20	10	6	30	4.5°	793155-5
25.4	12.7	6	32	3.18°	D-12968
31.8	15.9	6	32	4.76°	D-12974
25.4	12.7	8	32	3.18°	D-11639
31.8	15.9	8	32	4.76°	D-11645
38.1	19	12	38	6.35°	D-12952

DRILLING / FIXING

CONCRETE DRILLING / DEMOLITION

MIXING / STIRRING

CUTTING (CONCRETE / METAL)

GRINDING

SANDING / POLISHING

SAWING

MULTI-TOOL

ROUTERS / PLANERS

NAILERS / STAPLERS

HEAT GUN / LASER

CLEANING

OPE

JOB SITE TOOLS

SPECIALTY TOOLS

HAND TOOLS / COMBINATION SET

TOOL HOLDERS AND POUCHES / MAKPAC SYSTEM

DRILLING / FIXING

CONCRETE DRILLING / DEMOLITION

MIXING / STIRRING

CUTTING (CONCRETE / METAL)

GRINDING

SANDING / POLISHING

SAWING

MULTI-TOOL

ROUTERS / PLANERS

NAILERS / STAPLERS

HEAT GUN / LASER

CLEANING

OPE

JOB SITE TOOLS

SPECIALTY TOOLS

HAND TOOLS / COMBINATION SET

TOOL HOLDERS AND POUCHES / МАКРАС SYSTEM

## Double Ball Bearing Round Corner Bit

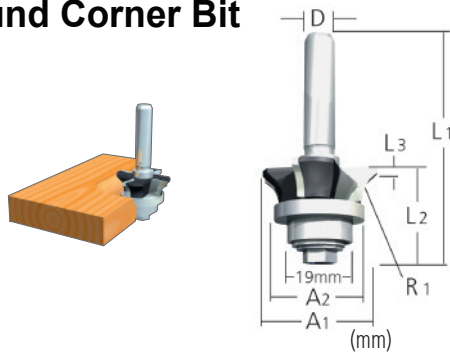

D	A1	A2	L1	L2	L3	R1	Part No.
12.7	35	27	70	11	3.5	3°	793093-1

## Chamfering Bit

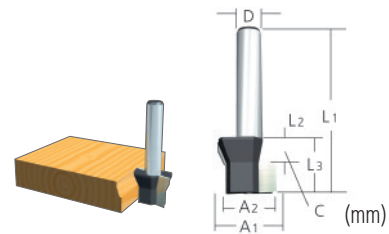

D	A1	A2	L1	L2	L3	C	Part No.
12.7	30	20	55	12	20	4°	793114-9

## Double Round Bit

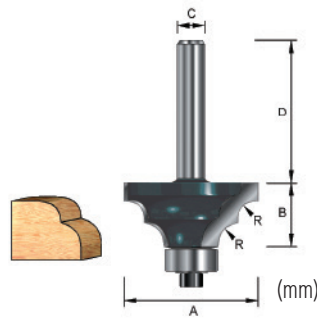

A	B	C	D	R	Part No.
31.8	14.28	6	32	4.76°	D-12784
31.8	14.28	8	32	4.76°	D-11411
38.1	17.46	12	38	6.35°	D-12778

## Chamfer Bit

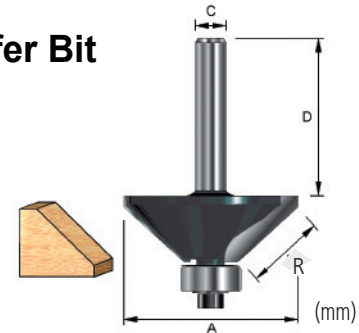

A	C	D	R	Part No.
23	6	35	30°	793144-0
20	6	35	60°	793145-8
26	8	32	45°	D-12837
57.15	12	38	45°	D-12821

## Cove Bit

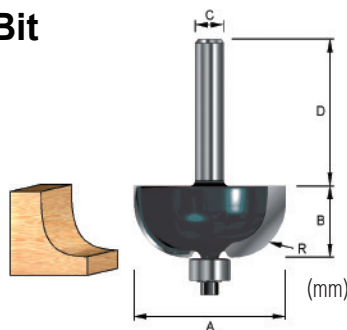

A	B	C	D	R	Part No.
15.9	9.5	6	32	3.18°	D-12790
19	9.5	6	32	4.76°	D-12809
22.2	9.5	6	32	6.35°	D-12815
28.6	12.7	8	32	9.52°	D-11477

## Cavetto Bit

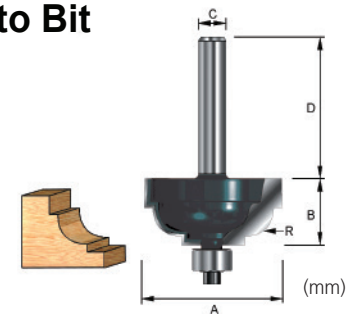

A	B	C	D	R	Part No.
25.4	12.7	6	32	4.76°	D-12996
28.6	14.28	6	32	6.35°	D-13007
28.6	14.28	8	32	6.35°	D-11673
31.8	15.9	8	32	7.94°	D-11689
31.8	15.9	12	38	7.94°	D-12980

### Wavy Mold Bit

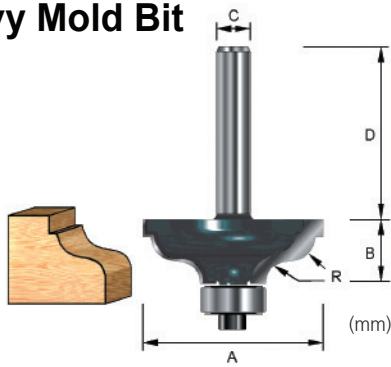

A	B	C	D	R	Part No.
31.8	14.28	8	32	3.18°	D-11695
31.8	14.28	12	38	3.18°	D-13013

### Bead & Cove Bit

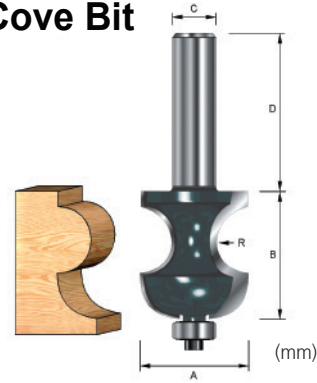

A	B	C	D	R	Part No.
31.8	36.51	8	38	9.52°	D-13063

### Decor Sunk Bead Bit / Radius Sunk Bead Bit

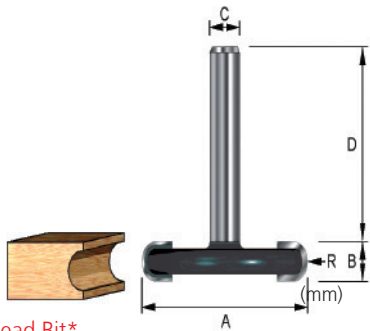

Radius Sunk Bead Bit\*

A	B	C	D	R	Part No.
38.1	6.35	6	32	3.18°	*D-13041
38.1	6.35	6	32	3.18°	D-13057
38.1	6.35	12	38	3.18°	D-13035

### Multi Reed Bit

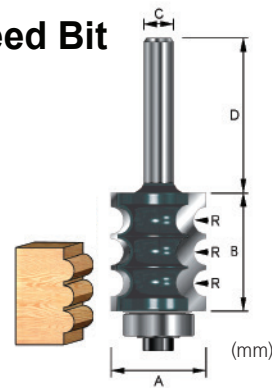

A	B	C	D	R	Part No.
22.2	25.4	6	32	3.18°	D-13079
22.2	25.4	8	32	3.18°	D-13085

### Three Bead Fluting Bit

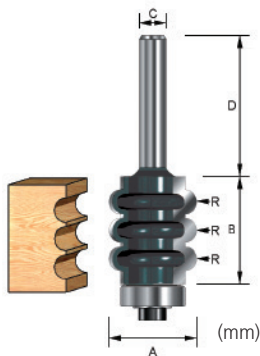

A	B	C	D	R	Part No.
22.2	25.4	6	32	3.18°	D-13091
22.2	25.4	8	32	3.18°	D-13100

### Cove & Bead Bit

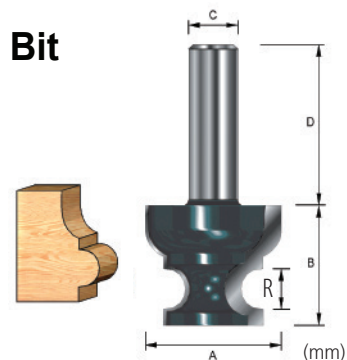

A	B	C	D	R	Part No.
28.6	22.2	12	38	6.35°	D-13116
41.28	31.8	12	38	12.7°	D-13122

DRILLING / FIXING

CONCRETE DRILLING / DEMOLITION

MIXING / STIRRING

CUTTING (CONCRETE / METAL)

GRINDING

SANDING / POLISHING

SAWING

MULTI-TOOL

ROUTERS / PLANERS

NAILERS / STAPLERS

HEAT GUN / LASER

CLEANING

OPE

JOB SITE TOOLS

SPECIALTY TOOLS

HAND TOOLS / COMBINATION SET

TOOL HOLDERS AND POUCHES / MAKPAC SYSTEM

DRILLING / FIXING

CONCRETE DRILLING / DEMOLITION

MIXING / STIRRING

CUTTING (CONCRETE / METAL)

GRINDING

SANDING / POLISHING

SAWING

MULTI-TOOL

ROUTERS / PLANERS

NAILERS / STAPLERS

HEAT GUN / LASER

CLEANING

OPE

JOBSITE TOOLS

SPECIALTY TOOLS

HAND TOOLS / COMBINATION SET

TOOL HOLDERS AND POUCHES / MAKPAC SYSTEM

### Moulding Bit

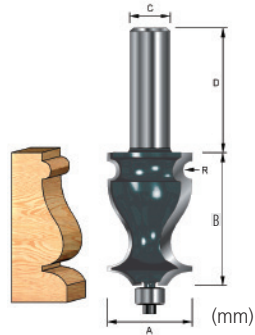

A	B	C	D	R	Part No.
17.46	25.4	6	32	3.18°	D-13194
19	25.4	6	32	1.98°	D-13203
19	25.4	6	32	1.98°	D-13219
17.46	25.4	8	32	3.18°	D-13225
19	25.4	8	32	1.98°	D-13231
23.8	34.9	12	38	3.97°	D-13138
23.8	34.9	12	38	3.97°	D-13144
26.99	41.28	12	38	3.18°	D-11748
25.4	34.9	12	38	3.97°	D-13150
25.4	42.8	12	38	3.18°	D-13166
34.9	41.28	12	38	3.18°	D-13172
38.1	38.1	12	38	3.18°	D-13188

### Multi Profile Bit

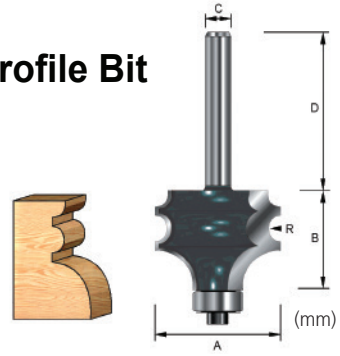

A	B	C	D	R	Part No.
31.8	23.8	12	38	3.18°	D-13253
34.9	19	12	38	2.38°	D-13269
50.8	30.1	12	38	4.76°	D-13275

### Slotting Cutter

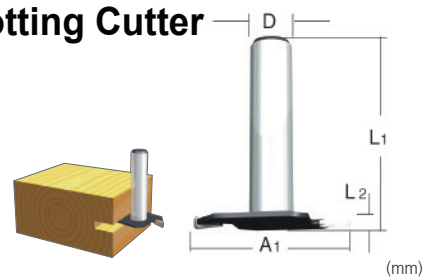

D	A1	L1	L2	Part No.
12	30	55	3	793067-2
12	30	55	6	793068-0

### Multi Profile Bit Decorative Bead Bit

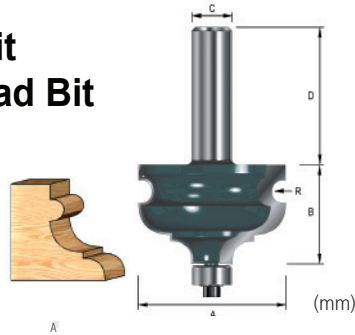

A	B	C	D	R	Part No.
25.4	22.2	12	38	3.97°	D-13247
44.45	28.6	12	38	3.18°	D-11754

### Variable Slot Cutter Set

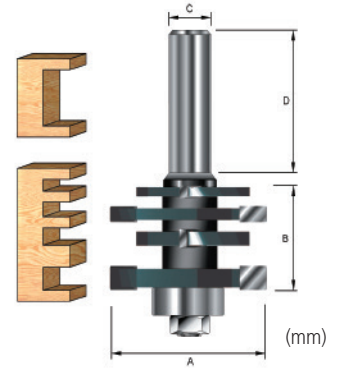

A	B	C	D	Part No.
47.6	18.2	12	38	D-13281

### Classical Multi Profile Bit

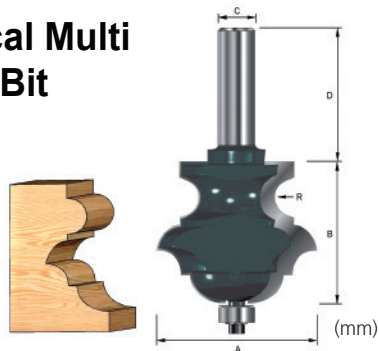

A	B	C	D	R	Part No.
31.8	25.4	8	32	3.97°	D-11760
57.15	47.6	12	45	3.18°	D-11776

### Traditional Table Edge Bit

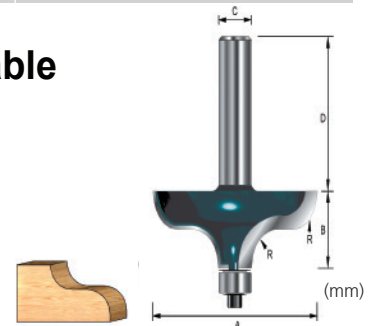

A	B	C	D	R	Part No.
63.5	19	12	38	9.52°	D-11807

### Thumb Mold Bit

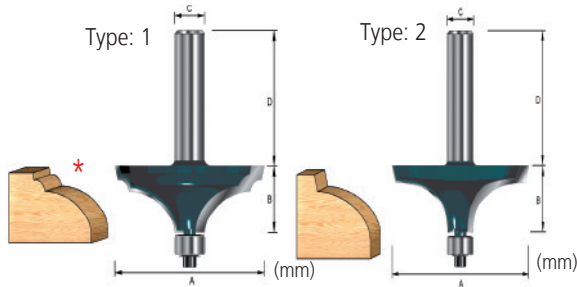

A	B	C	D	Type	Part No.
63.5	19	12	45	2	D-11782
63.5	19	12	38	1	D-13297

### Classic Ogee Bit

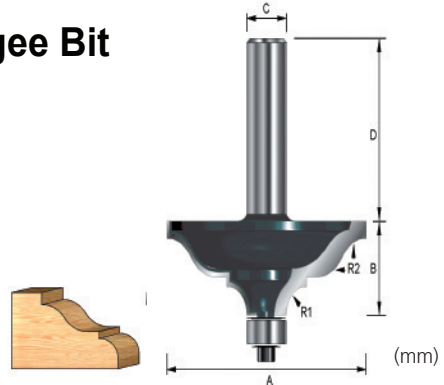

A	B	C	D	R	Part No.
63.5	19.84	12	38	R1=6.35°, R2=9.5°	D-11813

### Classic Profile Bit

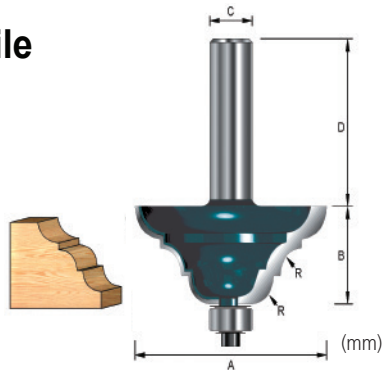

A	B	C	D	R	Part No.
57.15	22.2	12	38	6.35°	D-11798

### Handrail Bit

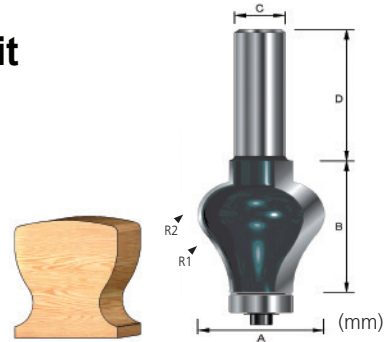

A	B	C	D	R	Part No.
31.8	38.1	12	38	R1=9.52°, R2=12.7°	D-13306

### Decorative Bead Bit

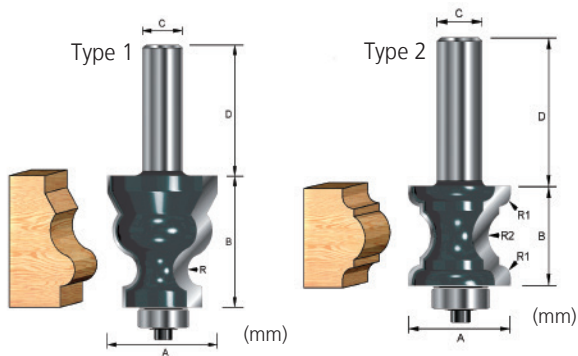

A	B	C	D	R	Type	Part No.
31.8	31.8	12	38	R1=3.97°, R2=7.94°	2	D-13312
34.9	41.28	12	38	R1=4.76°, R2=12.7°	2	D-13328
34.9	38.1	12	38	R = 4.76°	1	D-13334

### Crown Molding Bit

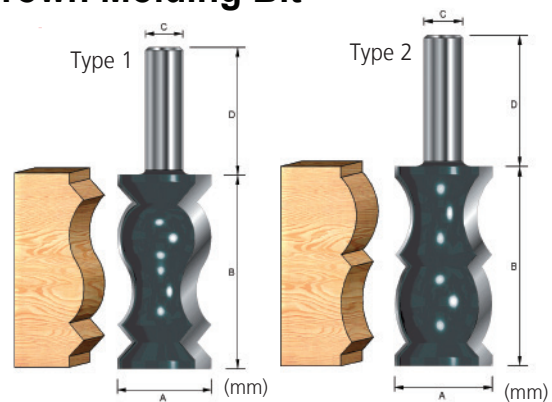

A	B	C	D	Type	Part No.
31.8	57.1	12	38	1	D-13801
31.8	57.1	12	38	2	D-13817

- DRILLING / FIXING
- CONCRETE DRILLING / DEMOLITION
- MIXING / STIRRING
- CUTTING (CONCRETE / METAL)
- GRINDING
- SANDING / POLISHING
- SAWING
- MULTI-TOOL
- ROUTERS / PLANERS
- NAILERS / STAPLERS
- HEAT GUN / LASER
- CLEANING
- OPE
- JOB SITE TOOLS
- SPECIALTY TOOLS
- HAND TOOLS / COMBINATION SET
- TOOL HOLDERS AND POUCHES / MAKPAK SYSTEM

DRILLING / FIXING

CONCRETE DRILLING / DEMOLITION

MIXING / STIRRING

CUTTING (CONCRETE / METAL)

GRINDING

SANDING / POLISHING

SAWING

MULTI-TOOL

ROUTERS / PLANERS

NAILERS / STAPLERS

HEAT GUN / LASER

CLEANING

OPE

JOBSITE TOOLS

SPECIALTY TOOLS

HAND TOOLS / COMBINATION SET

TOOL HOLDERS AND POUCHES / MAKPAC SYSTEM

### Bullnose Mould Bit

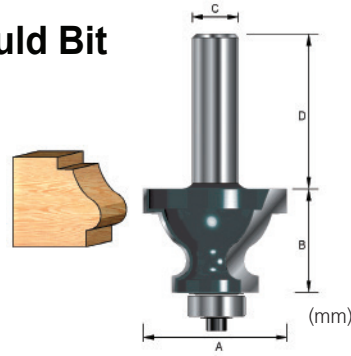

A	B	C	D	Part No.
39.68	25.4	12	38	D-13340

### Raised Panel Bit - Wavy

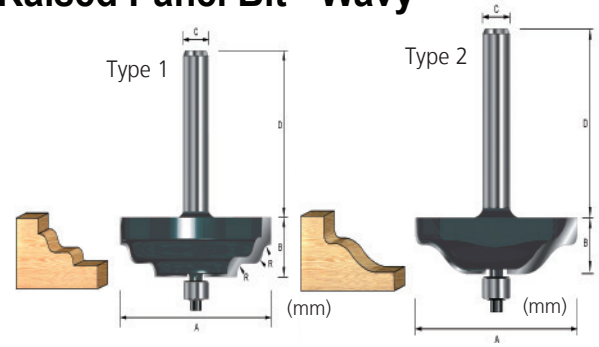

A	B	C	D	Type	Part No.
76.2	19	12	50	1	D-13356
76.2	15.9	12	50	2	D-13362
76.2	15.9	12	50	2	D-13378
76.2	15.9	12	50	2	D-13384

### Decorative Bead Bit

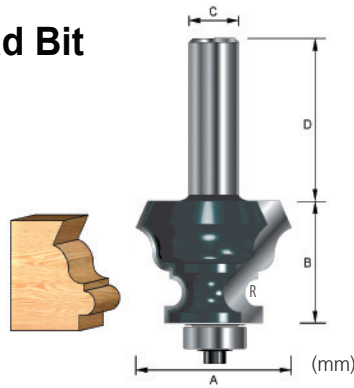

A	B	C	D	R	Part No.
39.7	28.6	12	38	3.18 <sup>0</sup>	D-13792

### Door Edge Bit

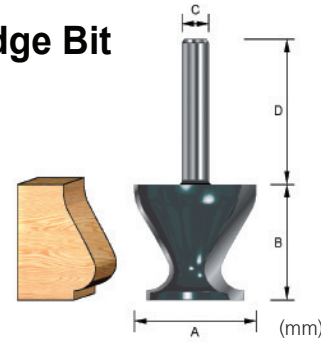

A	B	C	D	Part No.
31.8	25.4	8	32	D-13390

### Solid Surface Cutters - Ogee

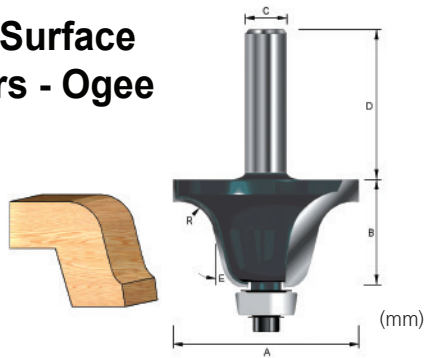

A	B	C	D	E	R	Part No.
51.15	31.8	12	40	15	12.7 <sup>0</sup>	D-13873

### Hinge Boring Bit

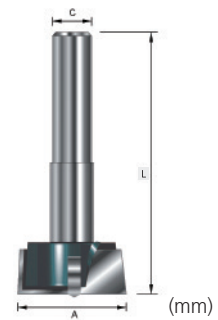

A	C	L	Part No.
20	8	76.2	D-13845
25	8	76.2	D-13867
22.22	10	76.2	D-13851
35	10	76.2	D-13758



### Board-Joining Bit

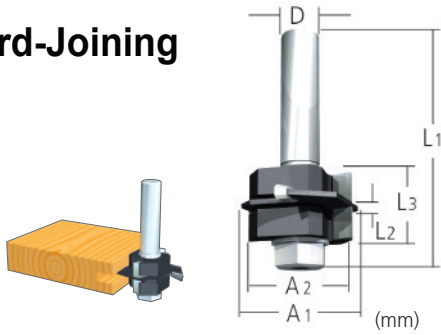

D	A1	A2	L1	L2	L3	Part No.
12	38	26	61	4	20	793189-8
12.7	38	26	61	4	20	793191-1

### Straight Sash Router Bit

For Model: 4402

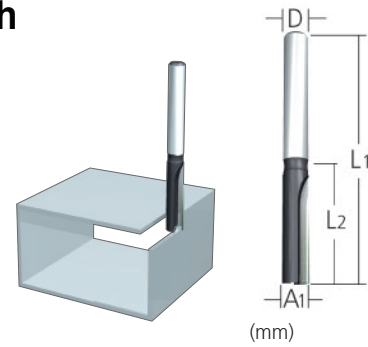

D	A1	L1	L2	Part No.
6	6	65	18	D-16988
6.35	6.5	60	15	793119-9

### Economy Tongue & Groove Set

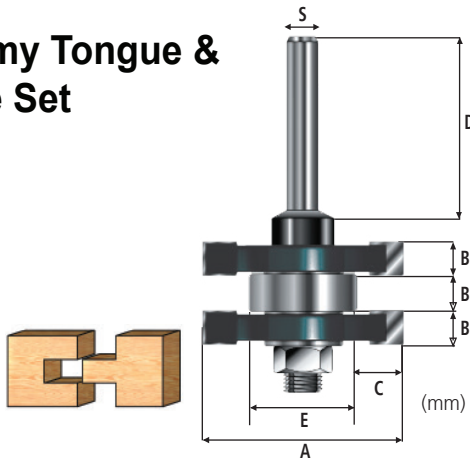

A	B	C	D	E	S	Part No.
41	6.35	9.5	32	32	8	D-12011
41	6.35	9.5	38	22	12	D-12027

### Double Drill Bit

For Model: 4402

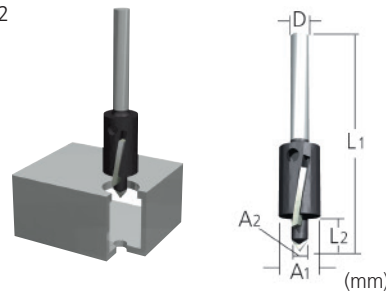

D	A1	A2	L1	L2	Part No.
6	12	6.5	60	12	793082-6
6.35	18	6.5	60	12	793115-7

### Ball Bearing

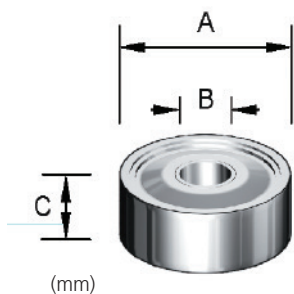

A	B	C	Part No.
9.52	4.76	3.18	D-13764
12.7	4.76	4.76	D-13770

### Router Bit Starter Set (3pcs / Set)

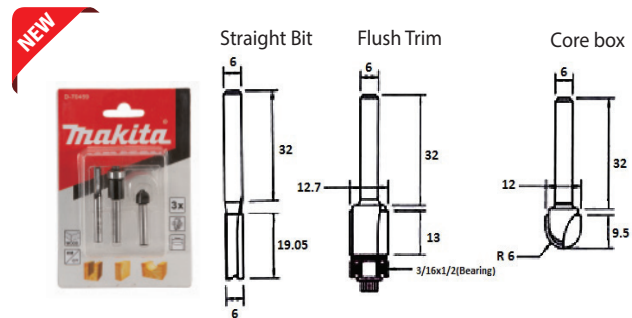

Type / Size	Dia	L	R	Shank	Bearing Size	Flutes	Part No.
Straight Bit	6	19.05	-	6	-	1	D-70459
Flush Trim Bit	12.7	13	-	6	12.7	2	
Core Box	12	9.5	6	6	-	2	

DRILLING / FIXING

CONCRETE DRILLING / DEMOLITION

MIXING / STIRRING

CUTTING (CONCRETE / METAL)

GRINDING

SANDING / POLISHING

SAWING

MULTI-TOOL

ROUTERS / PLANERS

NAILERS / STAPLERS

HEAT GUN / LASER

CLEANING

OPE

JOBSITE TOOLS

SPECIALTY TOOLS

HAND TOOLS / COMBINATION SET

TOOL HOLDERS AND POUCHES / MAKPAC SYSTEM

DRILLING / FIXING

CONCRETE DRILLING / DEMOLITION

MIXING / STIRRING

CUTTING (CONCRETE / METAL)

GRINDING

SANDING / POLISHING

SAWING

MULTI-TOOL

ROUTERS / PLANERS

NAILERS / STAPLERS

HEAT GUN / LASER

CLEANING

OPE

JOBSITE TOOLS

SPECIALTY TOOLS

HAND TOOLS / COMBINATION SET

TOOL HOLDERS AND POUCHES / MAKPAC SYSTEM

## Router Bit Set (12pcs / Set)

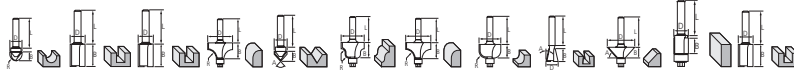

Size	1	2	3	4	5	6	7	8	9	10	11	12	Part No.
8mm	D:12.7 R:6.35 B:8.8	D:16.0 B:20.0 L:28.0	D:6.0 B:20.0 L:25.0	D:28.6 R:9.5 B:17.0 L:25.5	D:12.7 B:9.1 A:90° L:29.0	D:25.0 R:4.0 B:16.0 L:26.5	D:22.2 R:6.3 B:13.5 L:25.0	D:22.0 R:6.3 B:12.7 L:26.5	D:12.7 B:12.7 A:14° L:29.0	D:32.0 B:12.2 A:45° L:30.0	D:12.7 B:13.0 L:29.0	D:12.0 B:20.0 L:28.0	A-88054
6mm													A-87921

## Multipurpose Router Bits (22pcs Set)



Shank mm	Diameter mm	Overall Length mm	Carbide Height mm	Part No.	
<b>Straight Bit 2 Flutes</b>					
8	20	51	19	D-74778	
8	16	51	19		
8	12	51	19		
8	10	51	19		
8	8	51	19		
<b>Straight Bit 1 Flutes</b>					
8	6	51	19		
8	4	51	13		
8	3	51	13		
<b>Rounding Over</b>					
8	17.3	51	8		
8	19	53.4	9.5		
8	25.4	56.5	13.5		
8	22.2	55	12.7		
<b>Chamfer</b>					
8	30.2	54.5	12.7		
<b>Cove</b>					
8	22.2	55.6	12.7		
<b>Corebox</b>					
8	12.7	41.5	10		
<b>V Grooving</b>					
8	12.7	48	16		
8	12.7	44.7	12.7		
<b>Flush Trim</b>					
8	9.5	67	26		
8	12.7	68.5	26		
<b>Dovetail</b>					
8	15	52	14.3		
<b>Rabbeting</b>					
8	31.8	54.6	12.2		
<b>Panel Pilot Bit</b>					
8	6.35	65	19		

## Basic grooving Router Bits (22pcs Set)



Shank mm	Diameter mm	Overall Length mm	Carbide Height mm	Part No.	
<b>Straight Bit 2 Flutes</b>					
8	12	51	19	D-74784	
8	10	51	19		
8	8	51	19		
8	6	51	19		
8	6	48	16		
<b>Straight Bit 1 Flutes</b>					
8	6	51	19		
8	5	48	13		
<b>Corebox</b>					
8	6.35	38.3	6.35		
8	7.9	40	8		
8	12.7	41.5	10		
8	9.5	41.3	9.5		
<b>V Grooving</b>					
8	12.7	48	16		
8	12.7	44.7	12.7		
<b>Flush Trim</b>					
8	9.5	67	26		
<b>Dovetail</b>					
8	12.7	45	13		
8	9.5	40	9.5		
8	6.35	63.5	8		
<b>Panel Pilot Bit</b>					
	6.35	65	19		
<b>Round Nose Bit</b>					
8	6.35	44.5	12.7		
8	9.5	44.5	12.7		
<b>Keyhole Bit</b>					
8	9.5	48	10.5		
<b>Ball Groove Bit</b>					
8	9.5	41.3	8.3		

## Templet Guide

For fast production and complicated shapes by using templet.

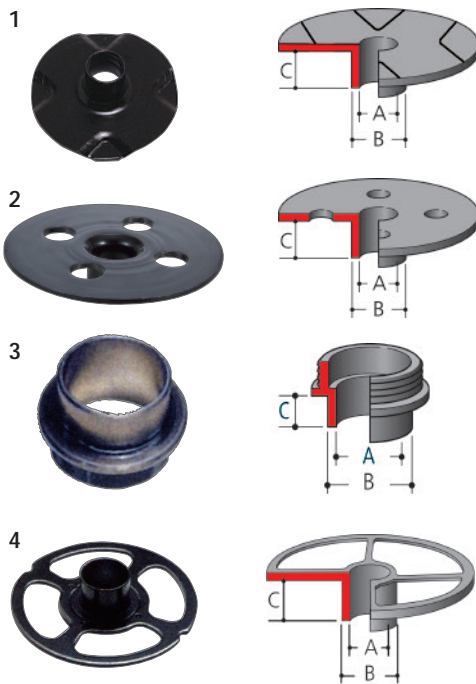

\*RT0700C & DRT50 - Use with base assembly

For Model	A (mm)	B (mm)	C (mm)	Part No.
3700B, N3701, 3703, 4402, 3709, 3710	8	10	9.5	343577-5
3606, 3612BR, 3620, 3612C, 3612, RP0900, RP1800, RP2300FC *RT0700C, *RT0702C, *DRT50, *RT001G	7.7	9.5	11.5	164379-4
	9	11	13	164775-6
	10	12	9	164388-3
	11	12.7	13	164776-4
	14	17	20	165366-6
	14.5	16	13	344364-5
	18	20	13	164393-0
	24	27	13	164470-8
	25	29	15	163080-8
	27	30	13	164471-6
3600, 3600H, 3601B	37	40	13	165046-4
	37	40	13	164472-4
	11.1	12.7	14.3	321472-9
	10.9	12.7	8	323449-0
RP0910, RP1110C	14	16	8	323018-7
	14	16	14.5	321308-2
	7.7	9.5	8	193330-7
	10.5	12	14	193332-3
	14	17	20	165365-8
	18	20	13	193335-7
	24	27	13	193336-5
25	29	13	193337-3	
37	40	13	193339-9	

## Templet Guide 25

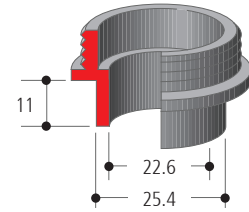

For Model	Part No.
All routers	321812-1

\*RT0700C, \*RT0702C \*DRT50, \*RT001G - Use with base assembly

## Templet Guide adapter 30

For B&D, Porter Cable, two-piece templet guide.

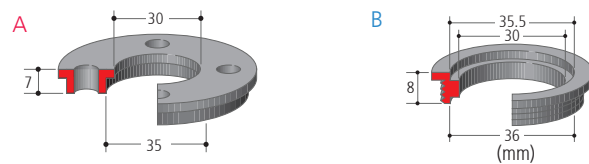

\*RT0700C & DRT50 - Use with base assembly

For Model	Type	Part No.
3612 /C/BR, 3620, RP0900, RP1800, RP2300FC, *RT0700C, *RT0702C, *DRT50, *RT001G	A	321492-3
3600/H, 3601B	B	321493-1

## Nut M30

Use with Templet Guide 25 and Templet Guide Adapter 30

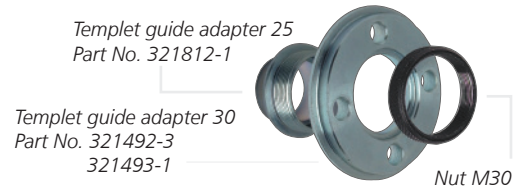

For Model	Part No.
All routers	252627-4



- DRILLING / FIXING
- CONCRETE DRILLING / DEMOLITION
- MIXING / STIRRING
- CUTTING (CONCRETE / METAL)
- GRINDING
- SANDING / POLISHING
- SAWING
- MULTI-TOOL
- ROUTERS / PLANERS
- NAILERS / STAPLERS
- HEAT GUN / LASER
- CLEANING
- OPE
- JOBSITE TOOLS
- SPECIALTY TOOLS
- HAND TOOLS / COMBINATION SET
- TOOL HOLDERS AND POUCHES / MAKPAC SYSTEM

DRILLING /  
FIXING

CONCRETE  
DRILLING /  
DEMOLITION

MIXING /  
STIRRING

CUTTING  
(CONCRETE /  
METAL)

GRINDING

SANDING /  
POLISHING

SAWING

MULTI-TOOL

ROUTERS /  
PLANERS

NAILERS /  
STAPLERS

HEAT GUN /  
LASER

CLEANING

OPE

JOBSITE  
TOOLS

SPECIALTY  
TOOLS

HAND TOOLS /  
COMBINATION SET

TOOL HOLDERS  
AND POUCHES /  
MAKPAC SYSTEM

## Straight Guide Assembly

A: Straight guide

B : Straight guide with  
micro adjustment

C: Guide Holder Assembly

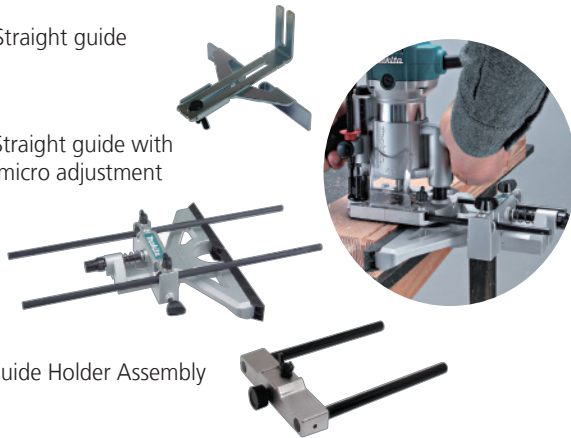

For Model	Type	Part No.
3700B, N3701, 3703, 4402	A	122391-0
3600, 3600H, 3601B	A	123029-0
3709, 3710	A	122704-5
3612BR	A	342428-9
RP0900, RP1110C, 3620	A	164834-6
3612BR, RP0900, RP0910 RP1100, RP1101, RP1800, RP2300FC, *RT0700C, *RT0702C, *DRT50, *RT001G	B Steel	193312-9
RP1800, RP2300FC, RP0900, RP1110C, *RT0700C, *RT0702C, *DRT50, *RT001G	B Aluminium	195136-9
3612BR, 3612C, 3612	C	122256-6
RP1800, RP2300FC	C	122700-3

\*RT0700C, \*RT0702C, \*DRT50, \*RT001G : Use with plunge base assembly

## Trimmer Guide Assembly



For Model	Part No.
3600H, 3601B, 3600	122343-1
3612BR, 3612C, 3612, RP1800, RP2300FC	123022-4
3620, RP0900, *RT0700C, *RT0702C, *DRT50, *RT001G	STEX122385
3709, 3710	122703-7

\*RT0700C, \*RT0702C, \*DRT50, \*RT001G : Use with plunge base assembly

## Guide Rail Adapter Set

A. Guide rail adapter set

B. Guide rail

C. Clamp set

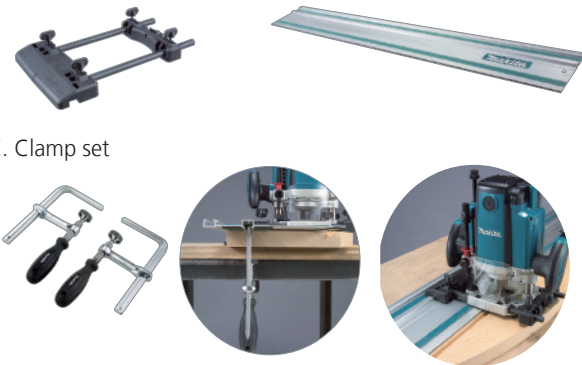

For Model	Type	Part No.
3612BR, RP0900, RP1800, RP2300FC, *RT0700C, *RT0702C, *DRT50, *RT001G	A	194579-2
Guide rail 1.4m	B	194368-5
Guide rail 3.1m	B	194367-7
Clamp set (2Pc)	C	194385-5

\*RT0700C, \*RT0702C, \*DRT50, \*RT001G : Use with plunge base assembly

## Collet Sleeve

Reduces collet size from :  
12mm to 10mm, 8mm or 6mm, 1/2" to 10mm, 3/8" or 1/4".

- Available for inch collet chuck.



For Model	Size	Part No.
3600, 3600H, 3601B, 3612BR, 3612, 3612C, RP1800, RP2300FC	6mm	763801-4
	6.35mm	763808-0
	8mm	763804-8
	10mm	763807-2
	• 1/4"	763803-0
3706	• 3/8"	763805-6
	• 10mm	763806-4
	3.18mm	324149-5

## Collet Cone (Collet Chuck)

- Collet chuck
- Collet cone assembly

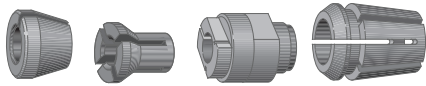

For Model	Size	Part No.
3700NB, N3701, 3703, 3704, 4402, 3606, 3706	6mm	763607-0
	6.35mm	763608-8
3709	6mm	763662-2
3710	12.7mm	763663-0
3600H, 3612BR, 3612C, 3612, RP1800 / RP2300FC	13mm	763632-1
	12mm	763628-2
	12.7mm	763622-4
3600, 3600BR, 3601B	12mm	•763601-2
	12.7mm	•763602-0
3620, RP0900, RT0700C, RT0702C, DRT50, RT001G	8mm	763618-5
	9.5mm	763619-3
	6mm	763636-3
	6.35mm	763637-1
RP1110	6mm	•193180-0

- DRILLING / FIXING
- CONCRETE DRILLING / DEMOLITION
- MIXING / STIRRING
- CUTTING (CONCRETE / METAL)
- GRINDING

## Trimmer Shoe

Enables accurate chamfering and similar edge work.



For Model	Part No.
3700B, N3701, 3703, 4402	155263-4

- SANDING / POLISHING
- SAWING

## Trimmer Base Assembly

- A. Transparent Base.
- B. For chamfering by Straight Bit.
- C. Fine depth adjustment.

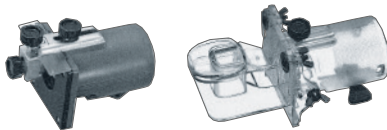

For Model	Type	Part No.
3700B, N3701, 3703, 4402	–	122202-9
	A	122238-8
	B	STEX122390
3709, 3710	–	122753-2
	B, C	194269-7

- MULTI-TOOL
- ROUTERS / PLANERS
- NAILERS / STAPLERS

## Sash Router Base Assembly



For Model	Part No.
3700B, N3701, 3703, 4402	JPA122201

- HEAT GUN / LASER
- CLEANING

## Base Assembly (Attachments) for RT0700C, RT0702C, DRT50, RT001G

- Able to meet a wide range of needs with the motor unit and the following various attachments
- Versatile system enables user to easily customize Model

### Plunge base assembly

Optional fine adjusting straight guide can be used.



Part No. 195563-0

### Tilt base assembly

Tilting capacity: -30° to 45°



Part No. 195561-4

### Offset base assembly

Able to trim close to wall and tight corners with a bit set in offset position.

Distance 18.5mm from the edge to the center of bit



Part No. 195562-2

### Trimmer base assembly

Standard with RT0700C, RT0702C, DRT50, RT001G



Part No. 196613-4

- OPE
- JOBSITE TOOLS
- SPECIALTY TOOLS
- HAND TOOLS / COMBINATION SET
- TOOL HOLDERS AND POUCHES / MAKPAC SYSTEM

## Planer Blade (2pcs per pkg)

DRILLING / FIXING

HSS (High Speed Steel planer blade).  
Fine cutting surface

CONCRETE DRILLING / DEMOLITION

TCT (Tungsten Carbide Tipped planer blade).  
Higher durability suitable for hard wood

MIXING / STIRRING



CUTTING (CONCRETE / METAL)



\* Use with set plate (343692-5)

GRINDING

SANDING / POLISHING

For Model	Size (mm)	Type	Part No	Part No (With country of origin)
1600	80	HSS	793001-2 A-07397	
1100, N1900B/K, 1902, N1923B/K, KP001G, KP0810, KP0800XK, DKP180 / DKP181	82	HSS	-	D-16346
1911B	110	HSS	D-71211	
1804N	136	HSS	793011-9	
			A-07428	
			793012-7	
1805N	155	HSS	D-70910	
2030	155	HSS	793018-5	
2030	155	HSS	793014-3	
2030N	320	HSS	793323-0	
2040	400	HSS	793019-3	
2012, 2012NB	306	HSS	*199911-5	

SAWING

## Mini Planer Blade (2pcs per pkg)

The blade has edges on both sides for long life.

MULTI-TOOL



ROUTERS / PLANERS



\* Use with set plate (343433-9)

For Model	Size (mm)	Type	Part No.
1100, N1900B/K, 1902, N1923B/K, KP0810, KP0800XK, DKP180 / DKP181, KP001G	82	TCT	* D-07945
2012, 2012NB	306	HSS	793346-8 (Disposable)

NAILERS / STAPLERS

## Sharpening Holder Assembly

For high speed steel blades

HEAT GUN / LASER

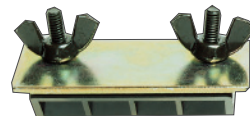

CLEANING

For Model	Size (mm)	Part No.
1100, N1900B/K, 1902, N1923B/K, KP0800XK, KP0810, DKP180 / DKP181	82	123004-6
1804N, 1805N, 1806B	136	123006-2
1002BA, 1911B	110	123055-9
KP001G		191C17-3

OPE

## Dressing Stone

For HSS planer blade

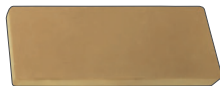

JOBSITE TOOLS

For Model	Size (mm)	Grit	Part No.
1100, N1900B/K, 1902, N1923B/K, KP0800XK, KP0810, DKP180 / 81, KP001G	150	WA1200	794061-7
1804N, 1805N, 1806B	180	WA1200	794060-9

SPECIALTY TOOLS

## Blade Gauge Assembly

For setting up of TCT and HSS blades

HAND TOOLS / COMBINATION SET



For Model	Part No.
1100, N1900B/K, 1902, N1923B/K, KP0800XK, KP0810, DKP180	122695-0
1804N, 1805N, 1806B	123009-6
2012NB	762016-0
DKP181, KP001G	191C19-9

TOOL HOLDERS AND POUCHES / MAKPAC SYSTEM

## Edge Fence (Guide Rule)

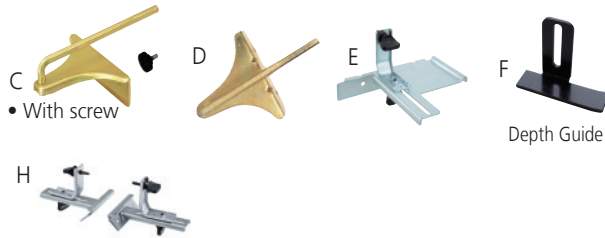

For Model	Type	Part No.
1805N	C	191454-3
N1900B, 1902, 1911B	C	191455-1
N1923B, 1923H	D	164371-0
KP001G	E	191C23-8
KP001G, DKP181, KP0810/C, N1923B, 1923H	F	342390-8
KP001G	H	191C22-0

- DRILLING / FIXING
- CONCRETE DRILLING / DEMOLITION
- MIXING / STIRRING

## Extension Guide Set

For adding length of the fence (use with D type (Hedge fence) Guide rule & screw)

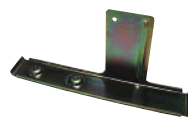

For Model	Part No.
N1900B/K, N1923B/K, 1902, 1911B, KP0800XK	191725-8

- CUTTING (CONCRETE / METAL)
- GRINDING
- SANDING / POLISHING

## Hood Set



For Model	Outer Dia (mm)	Part No.
2012NB	76mm	193036-7

- SAWING
- MULTI-TOOL

## Nozzle Assembly

Non-clogging hip deflection in desired direction



For Model	Part No.
1805N	JPA122197
N1900B, N1923B	JPA122194
DKP180 / DKP181 KP0810/C, KP0800 (Elbow)	416368-8
KP001G	191C20-4

- ROUTERS / PLANERS
- NAILERS / STAPLERS

## Planer Stand

L x W x H :  
442 x 271 x 450mm



For Model	Part No.
2012, 2012NB	193902-8

- HEAT GUN / LASER
- CLEANING
- OPE

## Triangular Rule



For Model	Part No.
1600, 1923H	762001-3

- JOBSITE TOOLS
- SPECIALTY TOOLS

## Magnetic Holder

For setting of blade

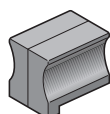

For Model	Part No.
2012, 2012NB	762014-4

- HAND TOOLS / COMBINATION SET
- TOOL HOLDERS AND POUCHES / MAKPAC SYSTEM

DRILLING /  
FIXING

## Dust Bag Assembly

For effective chip and dust collection



CONCRETE  
DRILLING /  
DEMOLITION

MIXING /  
STIRRING

CUTTING  
(CONCRETE /  
METAL)

## Hex Wrench



GRINDING

## Socket Wrench 9



SANDING /  
POLISHING

SAWING

MULTI-TOOL

ROUTERS /  
PLANERS

NAILERS /  
STAPLERS

HEAT GUN /  
LASER

CLEANING

OPE

JOBSITE  
TOOLS

SPECIALTY  
TOOLS

HAND TOOLS /  
COMBINATION SET

TOOL HOLDERS  
AND POUCHES /  
MAKPAC SYSTEM

For Model	Part No.
1100	STEX122312
1911B	122402-1
1923H	192268-3
1902, N1900B/K, N1923B/K	122230-4
1901	STEX122269
KP0810, KP0800XK, DKP180, DKP181	122793-0
KP001G	191C21-2

For Model	Size (mm)	Part No.
1806B, N1923B, 1911B	4.0	783202-0
2012NB	2.5	783208-8

For Model	Part No.
1100, N1900B/K, 1911B, N1923B/K, 1902, 1805N, KP0810, KP0800K, DKP180, DKP181	782209-3
2012NB	782203-5

## Plate Joiner Accessories

### Cutter Blade

- Carbide-tipped plate joiner blade

For Model	Dia (mm)	Bore Dia(mm)	Teeth	Tip thickness	Part No.
DPJ180, PJ7000, 3901	100	22	6	4	B-20644

### Cross-cut Saw Blade

- For smoother cross-cut work. Makes smoother cuts than combination blade.



For Model	Dia (mm)	Teeth	Tip thickness	Part No.
DPJ180, PJ7000, 3901	110	60	4mm	792012-4

### Set Plate

- To center joiner blade on 12mm stock while using pivoting fence.



For Model	Part No.
DPJ180, PJ7000, 3901	415579-2

### Angle Guide



For Model	Part No.
DPJ180, PJ7000, 3901	122473-8

### Biscuit (1000 pcs. in set)

- Premium quality.
- Select cut size.
- High strength.
- Finely ground edges.
- Compressed beachwood.

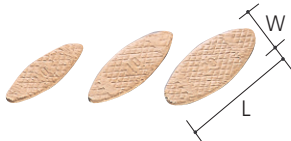

For Model	Type	L x W (mm)	Part No.
DPJ180, PJ7000, 3901	#0	46 x 15	P-08838
DPJ180, PJ7000, 3901	#10	54 x 19.5	P-08844
DPJ180, PJ7000, 3901	#20	56 x 23.5	P-08850



### Lock Nut Wrench



For Model	Part No.
DPJ180, PJ7000, 3901	782401-1

### Dust Bag

- For cleaner work area



For Model	Part No.
3901	122474-6
DPJ180	123150-5

## Chain Mortiser Accessories

### Cutter chain

A: Use with the sprocket (Part No. 221502-5) & chain bar (Part No. 122235-4)



For Model	Size (mm)	Type	Part No.
7104L	15	-	A-16564
	16.5	-	A-16570
	18	-	A-16586
	21	-	A-16592
	24	-	A-16601
	30	A	A-16617

### Oil supply 100 mL



For Model	Part No.
7104L	182229-1

- DRILLING / FIXING
- CONCRETE DRILLING / DEMOLITION
- MIXING / STIRRING
- CUTTING (CONCRETE / METAL)
- GRINDING
- SANDING / POLISHING
- SAWING
- MULTI-TOOL
- ROUTERS / PLANERS
- NAILERS / STAPLERS
- HEAT GUN / LASER
- CLEANING
- OPE
- JOBSITE TOOLS
- SPECIALTY TOOLS
- HAND TOOLS / COMBINATION SET
- TOOL HOLDERS AND POUCHES / MAKPAC SYSTEM

# Stapler, Pinner, Brad Nailer, Coil Nailer



**FN001G** 40V MAX | **XGT**

**Cordless Brad Nailer**



**High Power and High Speed Brad Nailer**

- XGT Li-Ion battery and BL motor quickly re-compress the spring for next firing
- Counterweight mechanism - reduces vibration
- Anti-dry fire mechanism - prevent driving blanks and damage to work surface
- Low recoil mechanism - reduces a recoil when shooting
- Contact arm mechanism - enables continuous nailing and drag nailing
- Contact top designed easy nail placement
- Slim nose with nose adapter

**40V MAX BL MOTOR XPT**

<b>Capacity</b>	Length: 15, 20, 25, 30, 35, 40 mm
	Gauge: 18 Ga
<b>Magazine Capacity</b>	100
<b>Vibration Level</b>	2.5 m/s <sup>2</sup> or less
<b>Sound Pressure Level</b>	81 dB(A)
<b>Sound Power Level</b>	92 dB(A)
<b>Dimensions (L x W x H)</b>	234 x 86 x 243 mm (without battery)
<b>Net weight</b>	1.9 kg (without battery)

**Standard Equipment:** Nose Adapter, Safety Goggles, Belt Clip, Hex Wrench

AVAILABLE VARIANTS	
<b>2.0Ah</b>	<b>"Z" VARIANT</b>
<b>FN001G A2</b> INCLUDES 2 BATTERIES / 1 CHARGER / MAKPAC CONNECTOR CASE	<b>FN001G Z</b> TOOL ONLY (DOES NOT INCLUDE BATTERY / CHARGER / CARRYING CASE)

**DFN350** 18V | **LXT**

**Cordless Brad Nailer**



**Ideal for light duty applications such as fastening chamfer strip to concrete form plywood wall**

- Counterweight mechanism - reduces vibration
- Anti-dry fire mechanism - prevent driving blanks and damage to work surface
- Low recoil mechanism - reduces a recoil when shooting
- Contact arm mechanism - enables continuous nailing and drag nailing
- Contact top designed easy nail placement
- Slim nose with nose adapter

**18V LXT XPT**

<b>Capacity</b>	Length: 15 - 35 mm / Gauge: 18 Ga
<b>Magazine Capacity</b>	110
<b>Shot q'ty on a single full battery charge</b>	w/ BL1850B: 4,000
<b>Vibration Level</b>	2.5 m/s <sup>2</sup> or less
<b>Sound Pressure Level</b>	81 dB(A)
<b>Sound Power Level</b>	92 dB(A)
<b>Dimensions (L x W x H)</b>	257x79x228 mm
<b>Net weight</b>	2.4 kg

**Standard Equipment:** Safety Goggles, Belt Clip, Hex Wrench

AVAILABLE VARIANTS	
<b>5.0Ah</b>	<b>"Z" VARIANT</b>
<b>DFN350 RTJ</b> INCLUDES 2 BATTERIES / 1 CHARGER / MAKPAC CONNECTOR CASE	<b>DFN350 Z</b> TOOL ONLY (DOES NOT INCLUDE BATTERY / CHARGER OR CARRY CASE)

**AF301**

**Pneumatic Brad Nailer**



**Accurate high caliber nailer**

- Durable and lightweight die cast housing
- 360 degree multi-direction exhaust ports
- Rubber handle
- Uses 18 gauge brad nails from 13/32" to 1-3/16" (10 mm to 30 mm)

**F/S**

<b>Operating air pressure</b>	65 PSIG (4.5 kgf / cm <sup>2</sup> G)
<b>Nail size</b>	Head : 2.0 mm (0.079")
	Shank width : 1.25mm (0.050")
	Shank thickness : 1.05mm (0.041")
	Gauge : 18
	Length : 10 - 30 mm (13/32" - 1-3/16")
<b>Nail capacities</b>	100
<b>Overall length</b>	250 mm (9-7/8")
<b>Net weight</b>	1.3kg (2.86 lbs)

**Standard Equipment:** Oil Supply, Hex Wrench

**AF506**

**Pneumatic Brad Nailer**



**18 Ga 50 mm (2") Pneumatic Brad Nailer**

- Durable and compact design with ease-of-use features
- Narrow nose design allows easy nailing access in confined areas
- "Tool-less" easy to clear nose for fast and easy nail extraction
- Easy to use "tool-less" depth adjustment dial for a wide variety of finish applications
- Built-in air duster provides convenient air flow to clear work surface
- Multi-directional exhaust port rotates 360° to direct exhaust air away from user.
- The cast-and-machined nose piece is engineered for precise contact with the workpiece, with a non-marring rubber nose engineered to protect the work surface.
- Ideal for trim work, baseboard and crown molding installation, flooring and other woodworking applications
- Dual nail reload indicator window alerts the user when to reload nails to avoid blank drives

**F/S**

<b>Capacity</b>	Length: 15 - 50 mm (5/8" - 2")
	Gauge: 18 Ga
<b>Operating Pressure</b>	0.49 - 0.83 MPa (70 - 120 PSI)
<b>Magazine Capacity</b>	100
<b>Dimensions (L x W x H)</b>	250x70x256 mm
<b>Net weight</b>	1.3 kg

**Standard Equipment:** Oil Supply, Safety Goggles, Nose Adapter, Hook

- DRILLING / FIXING
- CONCRETE DRILLING / DEMOLITION
- MIXING / STIRRING
- CUTTING (CONCRETE / METAL)
- GRINDING
- SANDING / POLISHING
- SAWING
- MULTI-TOOL
- ROUTERS / PLANERS
- NAILERS / STAPLERS
- HEAT GUN / LASER
- CLEANING
- OPE
- JOB SITE TOOLS
- SPECIALTY TOOLS
- HAND TOOLS / COMBINATION SET
- TOOL HOLDERS AND POUCHES / MAKPAC SYSTEM

- DRILLING / FIXING
- CONCRETE DRILLING / DEMOLITION
- MIXING / STIRRING
- CUTTING (CONCRETE / METAL)
- GRINDING
- SANDING / POLISHING
- SAWING
- MULTI-TOOL
- ROUTERS / PLANERS
- NAILERS / STAPLERS
- HEAT GUN / LASER
- CLEANING
- OPE
- JOBSITE TOOLS
- SPECIALTY TOOLS
- HAND TOOLS / COMBINATION SET
- TOOL HOLDERS AND POUCHES / MAKPAC SYSTEM

PT001G
40V MAX | XGT

**Cordless Pin Nailer**



**Quick firing thanks to XGT system and BL motor**

- Fires both vertically and horizontally
- High-quality finish nailing.
- Low recoil mechanism - enables easier nailing of long pins without pushing down the pin nailer firmly.
- Contact arm mechanism - enables continuous nailing and drag nailing
- Contact top designed easy nail placement
- Slim nose with nose adapter

<b>Capacity</b>	Length: 15, 18, 25, 30, 35 mm
	Dia.: 0.6 mm
	Gauge: 23 Ga
<b>Magazine Capacity</b>	120
<b>Dimensions (L x W x H)</b>	218 x 86 x 226 mm
<b>Net weight</b>	1.7 kg (without battery)

**Standard Equipment:** Nose Adapter, Safety Goggles, Belt Clip

AVAILABLE VARIANTS

<b>2.0Ah</b>	<b>"Z" VARIANT</b>
<b>PT001G A1</b> INCLUDES 1 BATTERY / 1 CHARGER / MAKPAC CONNECTOR CASE	<b>PT001G Z</b> TOOL ONLY (DOES NOT INCLUDE BATTERY / CHARGER / CARRYING CASE)

DPT353
18V | LXT

**Cordless Pin Nailer**



**Low Reaction Force Mechanism Enables Easier Long Pin Nailing and High-Quality Finish**

- Easy-to-see slim nose tip allows quick and easy access to a desired fastening point
- Nails can be fired in the groove of baseboard
- Shoots 6,400 nails on a single full BL1860B charge
- Contact arm mechanism enables "continuous nailing" and "drag nailing"

<b>Capacity</b>	Length: 15, 18, 25, 30, 35 mm
	(5/8", 11/16", 1", 1-3/16", 1-3/8")
	Dia.: 0.6 mm (1/32")
	Gauge: 23 Ga
<b>Magazine Capacity</b>	120
<b>Dimensions (L x W x H)</b>	257x79x226 mm
<b>Net weight</b>	2.3 kg

**Standard Equipment:** Nose Adapter, Safety Goggles, Belt Clip, Hex Wrench

AVAILABLE VARIANTS

"Z" VARIANT

**DPT353 Z**  
 TOOL ONLY (DOES NOT INCLUDE BATTERY / CHARGER OR CARRY CASE)

DPT351
18V | LXT

**Cordless Pin Nailer**



**"Hose-less" enables to perform efficient operation in interior finish work without being disturbed by air hose.**

- Uses pin nails from 18 to 35mm (11/16 to 1-3/8).
- Anti-dry-fire mechanism protects workpiece from damages.
- LED Job light for illuminated operation.
- Double trigger prevents accidental shooting.

<b>Capacity</b>	Length : 18,25,30,35mm
	(11/16,1,1-3/16,1-3/8")
	Diameter : 0.6mm (1/32")
<b>Magazine capacity</b>	130pcs
<b>Dimensions (L x W x H)</b>	249x79x227mm (9-3/4"x3-1/8"x8-15/16")
<b>Net weight</b>	1.8kg (4.0lbs)

**Standard Equipment:** Safety goggles, Hex wrench

AVAILABLE VARIANTS

"Z" VARIANT

**DPT351 Z**  
 TOOL ONLY (DOES NOT INCLUDE BATTERY / CHARGER OR CARRY CASE)

PT354D
12V MAX | CXT

**Cordless Pin Nailer**



**Low Reaction Force Mechanism Enables Easier Long Pin Nailing**

- High-Quality Finish
- Easy-to-see slim nose tip allows quick and easy access to a desired fastening point
- Nails can be fired in the groove of baseboard
- Contact arm mechanism enables "continuous nailing" and "drag nailing"

<b>Capacity</b>	Length: 15, 18, 25, 30, 35 mm
	Dia.: 0.6 mm / Gauge: 23 Ga
<b>Magazine Capacity</b>	120
<b>Dimensions (L x W x H)</b>	231x66x226 mm
<b>Net weight</b>	1.8kg

**Standard Equipment:** Nose Adapter, Safety Goggles, Belt Clip, Hex Wrench

AVAILABLE VARIANTS

"Z" Version

**PT354D Z**  
 TOOL ONLY (DOES NOT INCLUDE BATTERY / CHARGER OR CARRY CASE)

**DST112** 18V | **LXT**

**Cordless Stapler**



**Compact and Lightweight can Operable in either way of "contact actuation" or "single sequential actuation"**

- Lightweight for reduced operator fatigue
- Built-in LED job light illuminates the work area
- Contact actuation mode drives staples repetitively for quick operation
- Anti-dry-fire mechanism
- Low reaction force
- Continuous shooting



<b>Staple</b>	Width: 10 mm (3/8")
	Length: 7 - 10 mm (9/32" - 3/8")
	Gauge: 0.5 x 0.7 mm
<b>Magazine Capacity</b>	150pcs (max 160) with BL1830B
<b>Dimensions (L x W x H)</b>	235x79x165 mm
<b>Net weight</b>	1.8 kg

**Standard Equipment:** Safety Goggles, Hook

AVAILABLE VARIANTS

**"Z" VARIANT**

**DST112 Z**  
TOOL ONLY +MAKPAC CASE (DOES NOT INCLUDE BATTERY / CHARGER)

**DST221** 18V | **LXT**

**Cordless Stapler**



**Machined aluminum magazine ensures smooth staple loading and feeding.**

- Ergonomically designed rubberized grip provides more control and comfort.
- Driving depth adjustment is provided.
- Remaining staple view window.
- Staple can be fired one after the other.
- Contact arm for bump fire
- 4 stage depth control
- Machined aluminum magazine



<b>Capacity</b>	Width : 10mm (3/8")
	Length : 10, 13, 16, 19, 22mm
	(3/8, 1/2, 5/8, 3/4, 7/8")
<b>Magazine capacity</b>	98pcs : with BL1830B
<b>Dimensions (L x W x H)</b>	251x91x212mm
<b>Net weight</b>	2.4kg

**Standard Equipment:** Safety goggles

AVAILABLE VARIANTS

**"Z" VARIANT**

**DST221 Z**  
TOOL ONLY (DOES NOT INCLUDE BATTERY / CHARGER OR CARRY CASE)

**ST113D** 12V MAX | **CXT**

**Cordless Stapler**



**More Compact and lightweight Stapler**

- Operable in either way of "contact actuation" or "single sequential actuation"
- Contact actuation mode drives staples repetitively for quick operation
- Single sequential actuation mode drives one staple by one sequential operation
- Driving depth adjuster set 197731-1 (optional)



<b>Staple</b>	Width: 10 mm
	Length: 7 - 10 mm
	Gauge: 0.5 x 0.7 mm
<b>Magazine Capacity</b>	150 (max 160)
<b>Dimensions (L x W x H)</b>	211x81x159 mm
<b>Net weight</b>	1.3 kg

**Standard Equipment:** Safety Goggles, Belt Clip

AVAILABLE VARIANTS

**"Z" Version**

**ST113D Z**  
TOOL ONLY (DOES NOT INCLUDE BATTERY / CHARGER OR CARRY CASE)

**AT1025B**

**Pneumatic Stapler**



**Accurate and precise**

- Durable and lightweight die cast housing.
- 360 degrees multi-direction exhaust ports.
- Rubber handle.
- Uses 20 gauge staples from 13/32" to 1" (10 mm to 25 mm), crown size 1/5" (5.1mm).



<b>Operating air pressure</b>	65 PSIG (4.5 kgf / cm <sup>2</sup> G)
<b>Staple size</b>	Crown : 11.2mm (7/16")
	Width : 1.16mm (0.046")
	Thickness : 0.56mm (0.022")
	Gauge : 20
	Length : 10 - 25 mm (13/32" - 1")
<b>Staple capacities</b>	100
<b>Overall length</b>	250 mm (9-7/8")
<b>Net weight</b>	1.3 kg (2.86 lbs)

**Standard Equipment:** Oil Supply, Hex Wrench

- DRILLING / FIXING
- CONCRETE DRILLING / DEMOLITION
- MIXING / STIRRING
- CUTTING (CONCRETE / METAL)
- GRINDING
- SANDING / POLISHING
- SAWING
- MULTI-TOOL
- ROUTERS / PLANERS
- NAILERS / STAPLERS
- HEAT GUN / LASER
- CLEANING
- OPE
- JOB SITE TOOLS
- SPECIALTY TOOLS
- HAND TOOLS / COMBINATION SET
- TOOL HOLDERS AND POUCHES / MAKPAC SYSTEM

- DRILLING / FIXING
- CONCRETE DRILLING / DEMOLITION
- MIXING / STIRRING
- CUTTING (CONCRETE / METAL)
- GRINDING
- SANDING / POLISHING
- SAWING
- MULTI-TOOL
- ROUTERS / PLANERS
- NAILERS / STAPLERS
- HEAT GUN / LASER
- CLEANING
- OPE
- JOBSITE TOOLS
- SPECIALTY TOOLS
- HAND TOOLS / COMBINATION SET
- TOOL HOLDERS AND POUCHES / MAKPAC SYSTEM

## AT1225BZ

### Pneumatic Stapler



#### Accurate and precise

- Durable and lightweight die cast housing.
- 360 degrees multi-direction exhaust ports.
- Rubber handle.
- Uses 21 gauge staples from 13/32" to 1" (10 mm to 25 mm), crown size 1/5" (5.1mm).

#### Specifications:-

<b>Operating air pressure</b>	60 PSIG (4 kgf / cm <sup>2</sup> G)
<b>Staple size</b>	Crown : 12.95mm (1/2")
	Width : 0.95mm (0.037")
	Thickness : 0.66 mm (0.026")
	Gauge : 21
	Length : 10 - 25 mm (13/32" - 1")
<b>Staple capacities</b>	100
<b>Overall length</b>	250mm (9-7/8")
<b>Net weight</b>	1.3kg (2.86 lbs)

**Standard Equipment:** Oil Supply, Hex Wrench

## AT425B

### Pneumatic Stapler



#### Robust - uses 20 Gauge staples

- Durable and lightweight die cast housing.
- 360 degree multi-direction exhaust ports.
- Rubber handle.
- Uses 20 gauge staples from 13/32" to 1" (10 mm to 25 mm), crown size 1/5" (5.1mm).



<b>Operating air pressure</b>	65 PSIG (4.5 kgf / cm <sup>2</sup> G)
<b>Staple size</b>	Crown : 5.1mm (0.20")
	Width : 1.14mm (0.045")
	Thickness : 0.58mm (0.023")
	Gauge : 20
	Length : 10 - 25 mm (13/32" - 1")
<b>Staple capacities</b>	100
<b>Overall length</b>	250 mm (9-7/8")
<b>Net weight</b>	1.3 kg (2.86 lbs)

**Standard Equipment:** Oil Supply, Hex Wrench

## AN613

### Pneumatic Coiler Nailer



#### Pneumatic coil nailer powered by normal pressure air

- Efficient motor and trigger design offers leading fastening performance
- "Tool-less" depth adjustment
- 2-mode selector switch; single sequential mode and contact actuation mode
- Smooth nose tip prevents scratching
- Multi-directional exhaust port directs exhaust air away from operator
- Reversible belt hook allows the tool to remain close
- Clear loading canister with nail size adjustment allows user to quickly view the nails
- Anti-slip ribs added to the grip rubber provides more control
- Ergonomic rubberized grip for increased comfort on the job
- Built-in air duster provides convenient air flow to clear work materials and tools
- Rubber bumpers protect work surface and tool
- Low noise & Low recoil
- Ideal for installing fiber cement and wood shingle siding, sub-floor framing, exterior nailing, interior nailing, framing



<b>Capacity</b>	Length: 38 - 65 mm
<b>Nail gauge</b>	Gauge: 2.3 - 2.5 mm
	70 - 120 psi
<b>Operating Pressure</b>	0.49 - 0.83 MPa (70 - 120 PSI)
<b>Magazine Capacity</b>	200 - 300
<b>Dimensions (L x W x H)</b>	250x70x256 mm
<b>Net weight</b>	2.2 kg

**Standard Equipment:** Safety Goggles, Nose Adapter, Hook, Hex Wrench

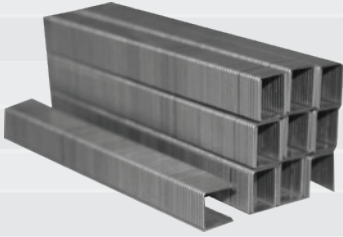
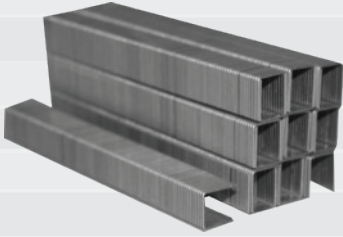
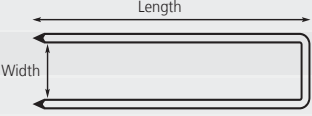

## Staples

For Model		W X L (mm)	Pcs/Pkg	Part No.
AT425B		4 x 10	5,000	B-04400
		4 x 13		B-04416
		4 x 16		B-04422
		4 x 19		B-04438
		4 x 22		B-04444
		4 x 25		B-04450
AT1025B		10 x 10	5,000	B-04466
		10 x 13		B-04472
		10 x 16		B-04488
		10 x 19		B-04494
		10 x 22		B-04503
		10 x 25		B-04519
AT1225BZ		12 x 10	5,000	B-04525
		12 x 12		B-04531
		12 x 14		B-04547
		12 x 16		B-04553
		12 x 18		B-04569
		12 x 20		B-04575
		12 x 25		B-04581

For Model		W X L (mm)	Pcs/Pkg	Part No.
DST221Z		10 x 10	5,040	F-32647
		10 x 13		F-32650
		10 x 16		F-32663
		10 x 19		F-32676
		10 x 22		F-32689
DST112, ST113D		7 x 10	25,000	F-81518
		10 x 10	15,000	F-81521

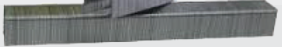
## Driving depth adjustment

Driving depth is adjustable by installing the optional Adjuster set

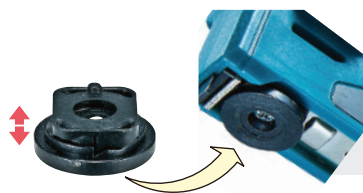

For Model	Part No.
DST112, ST113D	197731-1

- DRILLING / FIXING
- CONCRETE DRILLING / DEMOLITION
- MIXING / STIRRING
- CUTTING (CONCRETE / METAL)
- GRINDING
- SANDING / POLISHING
- SAWING
- MULTI-TOOL
- ROUTERS / PLANERS
- NAILERS / STAPLERS
- HEAT GUN / LASER
- CLEANING
- OPE
- JOB SITE TOOLS
- SPECIALTY TOOLS
- HAND TOOLS / COMBINATION SET
- TOOL HOLDERS AND POUCHES / MAKPAC SYSTEM

DRILLING /  
FIXING

CONCRETE  
DRILLING /  
DEMOLITION

MIXING /  
STIRRING

CUTTING  
(CONCRETE /  
METAL)

GRINDING

SANDING /  
POLISHING

SAWING

MULTI-TOOL

ROUTERS /  
PLANERS

NAILERS /  
STAPLERS

HEAT GUN /  
LASER

CLEANING

OPE

JOBSITE  
TOOLS

SPECIALTY  
TOOLS

HAND TOOLS /  
COMBINATION SET

TOOL HOLDERS  
AND POUCHES /  
MAKPAC SYSTEM

## Brad Nails

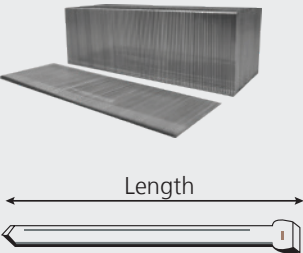
For Model		Length (mm)	Pcs/Pkg	Part No.
AF301, AF506 DFN350, FN001G		15	5,000	B-04307
		20		B-04313
		25		B-04329
		30		B-04335
		35		B-04357
AF506, DFN350, FN001G		40		B-04379 / F-31931
AF506, FN001G		45		B-04385
AF506		50		B-04391

## Pin Nails

For Model		Length (mm)	Pcs/Pkg	Part No.
AF201Z, DPT351, DPT353, PT354D, PT001G		18mm	10,000	F-31825
AF201Z, DPT351, DPT353, PT354D, PT001G		25mm		F-31838
DPT351Z, DPT353, PT354D, PT001G		30mm		F-31841
DPT351Z, DPT353, PT354D, PT001G		35mm		F-31854

## Coil Nails

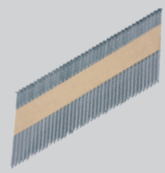
For Model		Dia (mm)	Length (mm)	Pcs/Pkg	Part No.	
AN613		Smooth	2.5 mm	45mm	10,800	F-30810
		Screw Chisel	2.5 mm	50mm	10,800	F-30865
		Smooth	2.5 mm	50mm	10,800	F-31243
		Screw Chisel	2.5 mm	57mm	8,100	F-30878
		Smooth	2.5 mm	57mm	8,100	F-31256
		Smooth	2.5 mm	65mm	8,100	F-30900
		Screw Chisel	2.5 mm	65mm	8,100	F-31269



# Heat Gun

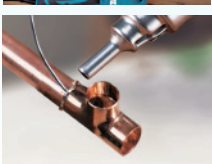
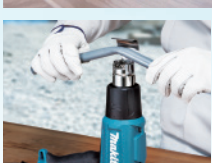
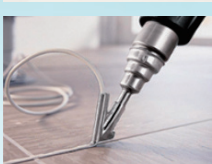

- DRILLING / FIXING
- CONCRETE DRILLING / DEMOLITION
- MIXING / STIRRING
- CUTTING (CONCRETE / METAL)
- GRINDING
- SANDING / POLISHING
- SAWING
- MULTI-TOOL
- ROUTERS / PLANERS
- NAILERS / STAPLERS
- HEAT GUN / LASER
- CLEANING
- OPE
- JOB SITE TOOLS
- SPECIALTY TOOLS
- HAND TOOLS / COMBINATION SET
- TOOL HOLDERS AND POUCHES / MAKPAC SYSTEM

DHG181
18V |

**Cordless Heat Gun**



**Powerful Cordless Heat gun produce 200 L/min max air flow**

- Max 550 degrees Celsius air temperature for a wide range of cordless works, e.g. putting up wall paper, drying or removal of paint, and more
- Max air flow of 200 L/min
- Quick release mechanism - Nozzle can be removed without touching the hot metal part simply by turning Plastic ring
- Up to 30 minutes of continuous run time with 18V LXT 6.0Ah Battery

**Air Temperature (°C)** Ambient temperature - 550

**Air Flow** Stage 1: 120 L/min / Stage 2: 200 L/min

**Continuous run time (min.)** w/ BL1860B: 21min

**Dimensions (L x W x H)** 173 x 79 x 255 mm

**Net weight** 0.73 kg (without battery)

**Continuous run time**  
At max air temperature 550°C, Air Flow: 200L/min (Stage 2)

about 21 min

Battery: BL1860B (on a full battery charge)

**Standard Equipment:** Glass protection nozzle, Wide-slot nozzle, Reflector nozzle, Reduction nozzle

AVAILABLE VARIANTS

<b>5.0Ah</b>	<b>"Z" VARIANT</b>
<b>DHG181 RT</b> <small>INCLUDES 1 BATTERY / 1 CHARGER / CARRY CASE</small>	<b>DHG181 ZK</b> <small>TOOL ONLY (WITH CARRY CASE) (DOES NOT INCLUDE BATTERY / CHARGER)</small>

HG5030

**Heat gun**



NEW

**New design with easy-to-operate slide switch**

- 1,600W class
- Temperature Settings / Stages: Slide Switch / 2 Stages
- Airflow setting Slide switch / 2 stages (temperature setting activated)
- Ergonomic soft rubber grip design for comfortable operation
- Various optional nozzles

**Continuous rating input** 1,600W

**Air Temperature (°C) / Flow (L/min)** Stage 1: 350 / 300  
Stage 2: 500 / 500

**Dimensions (L x W x H)** 233 x 80 x 208 mm

**Net weight** 0.56 kg (1.2 lbs.)

**Power supply cord** 2.0 m

**Standard Equipment:** (Nozzles does not comes with the tool)

HG6030K

**Heat gun**



**New design with easy-to-operate slide switch**

- 1,800W class
- Temperature Settings / Stages: Slide Switch / 2 Stages plus cooling mode
- Airflow setting Slide switch / 3 stages (temperature setting activated)
- Ergonomic soft rubber grip design for comfortable operation
- Various optional nozzles

**Continuous rating input** 1,800W

**Air Temperature (°C) / Flow (L/min)** Switch 1: 50 / 250  
Switch 2: 300 / 250  
Switch 3: 600 / 500

**Dimensions (L x W x H)** 233x80x208 mm

**Net weight** 0.57 kg

**Power supply cord** 2.0 m

**Standard Equipment:** Comes with carry case. (Nozzles does not comes with the tool)

HG6531CK

**Heat gun**



**New design with Preset function and liquid crystal display**

- 2,000W class
- Temperature Settings / Adjustment interval : Push button switch / by every 5° C.
- Airflow setting: Push button / 5 stages
- Preset function - Depending on intended use, you can recall the saved settings and easily set the temperature and air flow volume.
- The name of each setting is displayed on the LCD screen.
- Various optional nozzles

**Continuous rating input** 2,000W

**Air Temperature (°C)** 50 - 650

**Air Flow** 200 - 550 L/min

**Dimensions (L x W x H)** 253x85x205 mm

**Net weight** 0.72 kg

**Power supply cord** 2.0 m

**Standard Equipment:** Includes various types of nozzles. Comes with carry case.

**HG6530V****Heat gun****New design with Variable temperature heat gun with LCD Digital Display**

- 2,000W class
- Ideal for vehicle wraps and tinting, stripping lacquer, paint and varnish, thawing frozen pipes, loosening tile and putty, re-melting adhesive, removing stickers, waxing and de-waxing, bending plastic pipes and sheets, and more
- Various optional nozzles



<b>Continuous rating input</b>	2,000W
<b>Air Temperature (°C)</b>	50 - 650
<b>Air Flow</b>	Stage 1: 280 L/min Stage 2: 280 L/min Stage 3: 550 L/min
<b>Dimensions (L x W x H)</b>	253x85x205 mm
<b>Net weight</b>	0.73 kg
<b>Power supply cord</b>	2.0 m

Nozzles and carry case does not comes with the tool

**Heat Gun Accessories**

For models : DHG181/ HG6030K / HG6531CK / HG6530V / HG5030

Shape		Part No.
	Glass protection nozzle	PR00000028
	Wide - slot nozzle	PR00000029
	Reflector nozzle	PR00000030
	Reduction nozzle 20	PR00000031
	Overlap welding nozzle	PR00000032
	Solder sleeves reflector	PR00000033
	Welding nozzle	PR00000034
	Speed welding nozzle	PR00000039

For models : HG6020 / HG651C/K, HG5012/K, HG1100, HL500

	Part no.	HG6020	HG651C/K	HG5012/K	HG1100	HL500
Reflector Nozzle	53155000 103155000	●			●	●
	P-71445		●	●		
Reduction Nozzle	103155100	●			●	
	P-71439		●			
Welding Nozzle	53155200 103155200				●	
	P-71451		●			
Soldering Reflector Nozzle	53155300				●	
Surface Nozzle 75mm	103154900	●			●	●
Wide-slot Nozzle	P-71423		●	●		
Overlap Welding Nozzle	P-71489		●			

**Pressure Roller and Plastic welding Rod (Universal)**

Shape		Part No.
Pressure Roller		P-71504
Pressure roller		PR00000035

Shape		Part No.
Plastic Welding Rod		PVC Plastic 103154700
		ABS Plastic 103154800

DRILLING / FIXING

CONCRETE DRILLING / DEMOLITION

MIXING / STIRRING

CUTTING (CONCRETE / METAL)

GRINDING

SANDING / POLISHING

SAWING

MULTI-TOOL

ROUTERS / PLANERS

NAILERS / STAPLERS

HEAT GUN / LASER

CLEANING

OPE

JOBSITE TOOLS

SPECIALTY TOOLS

HAND TOOLS / COMBINATION SET

TOOL HOLDERS AND POUCHES / MAKPAC SYSTEM

# Laser

Laser Distance Measures, Rotary Laser,  
Cross line Laser



SK312GD

12V MAX | CXT

Rechargeable Green Multi Line Laser

Large handle prevents the tool from falling

Shock absorbing construction prevents the tool from vibration during transport

Leveling accuracy  
**± 1 mm / 10 m**



Allows to be charged from LXT batteries by using USB adapter ADP05 and power supply cable. Power supply cable: 199006-4

Brightness indicator

Bright  
Normal  
Eco mode



Line beam mode selection  
Laser line selection

- Fine adjustment knob fine-adjusted from either side by turning fine-adjustment knob
- Adjustment screw leg Horizontal line can be adjusted at any places
- Aluminium Storage case



Horizontal / 3-Vertical lines

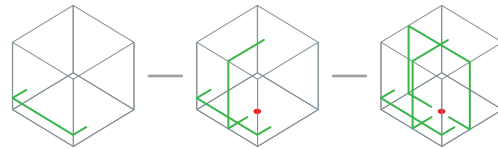

Leveling accuracy	1 mm / 10 m
Self-leveling range	2
Laser fan angle	Horizontal: 110° / Vertical: 130°
Number of laser lines	3
Laser type	Laser class 2: 515 nm
Operating Temperature	-10 - 40°C
Tripod thread	5/8"
Protection class	IP54
Operating Time (Approx. Hours)	10 - 28
Dimensions (L x W x H)	122 x 110 x 225 mm
Net weight	1.6 kg

Standard Equipment: Laser Viewing Glass, Shoulder Strap, Storage Case

AVAILABLE VARIANTS

"Z" Version

SK312GD Z  
TOOL + ALUMINIUM STORAGE CASE (DOES NOT INCLUDE BATTERY / CHARGER)

DRILLING / FIXING

CONCRETE DRILLING / DEMOLITION

MIXING / STIRRING

CUTTING (CONCRETE / METAL)

GRINDING

SANDING / POLISHING

SAWING

SK40GD

12V MAX | CXT

Rechargeable Green Multi Line Laser

Leveling accuracy  
**± 1 mm / 10 m**



Stand: minimizes accidental overturning of the tool body



Optional AA battery pack ADP09 Available as an emergency power source when the capacity of CXT battery runs out Able to supply power directly from the CXT battery port by using ADP09 with 8 nos of AA batteries

Brightness indicator

Normal  
Eco mode



Laser line selection  
Line beam mode selection

- Fine adjustment knob fine-adjusted from either side by turning fine-adjustment knob
- Adjustment screw leg Horizontal line can be adjusted at any places

Horizontal / 4-Vertical lines

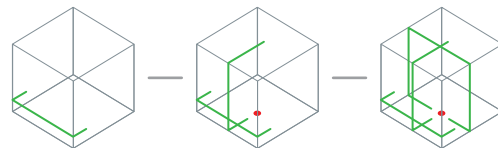

Leveling accuracy	1 mm / 10 m
Self-leveling range	4
Laser type	Laser class 2: 515 nm
Operating Temperature	-10 - 40°C
Protection class	IP54
Net weight	1.6 kg

Standard Equipment:  
Laser Viewing Glass, Storage Pouch

AVAILABLE VARIANTS

"Z" Version

SK40GD Z  
TOOL + STORAGE POUCH (DOES NOT INCLUDE BATTERY / CHARGER)

MULTI-TOOL

ROUTERS / PLANERS

NAILERS / STAPLERS

HEAT GUN / LASER

CLEANING

OPE

JOB SITE TOOLS

SPECIALTY TOOLS

HAND TOOLS / COMBINATION SET

TOOL HOLDERS AND POUCHES / MAKPAC SYSTEM



12V max Lithium-ion Battery



- DRILLING / FIXING
- CONCRETE DRILLING / DEMOLITION
- MIXING / STIRRING
- CUTTING (CONCRETE / METAL)
- GRINDING
- SANDING / POLISHING
- SAWING
- MULTI-TOOL
- ROUTERS / PLANERS
- NAILERS / STAPLERS
- HEAT GUN / LASER
- CLEANING
- OPE
- JOBSITE TOOLS
- SPECIALTY TOOLS
- HAND TOOLS / COMBINATION SET
- TOOL HOLDERS AND POUCHES / MAKPAC SYSTEM

**SK700GD**

12V MAX | **CXT**

**Rechargeable Multi Line Laser**

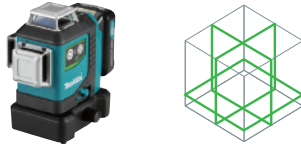

3 x full 360-degree lines

**GREEN**

Levelling unlocked

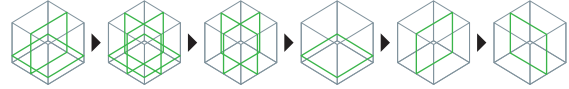

Levelling locked

For tilt applications

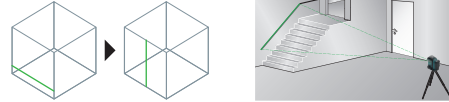

**Full 360-degree line is created by letting the laser from a light source reflect on a con mirror.**

- Rotary base with eccentric rotation mechanism reduces setup time.
- Vertical laser lines can rotate around the defined plumb point up to 10° left and right (with a dial for fine adjustment).
- Eccentric rotation mechanism enables the laser body to rotate without changing the position of the defined plumb point, enabling easy line positioning.

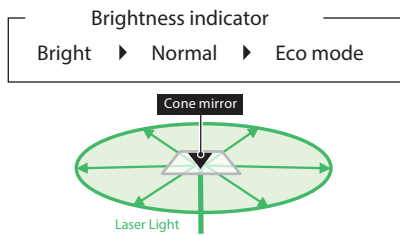

Measuring range	Up to: 35 m
Measuring range w/ detector	Up to: 70 m
Leveling accuracy	±2 mm / 10 m
Self-leveling range	±4°
Laser type	Laser class 2: 510 - 530 nm
Operating Temperature	-10 - 50°C
Protection class	IP54
Continuous Runtime (Approx. Hours)	14 hours (with 4.0Ah battery)
Dimensions (L x W x H)	w/ BL1041B: 168 x 104 x 153 mm
Net weight	1.2 kg

**Standard Equipment:** Target Plate, Adapter, Soft Bag

**AVAILABLE VARIANTS**

**"Z" Version**

**SK700GD Z**  
TOOL ONLY  
(DOES NOT INCLUDE BATTERY / CHARGER OR CARRY CASE)

**SK700D**

12V MAX | **CXT**

**Rechargeable Multi Line Laser**

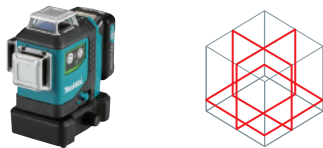

3 x full 360-degree lines

**RED**

Levelling unlocked

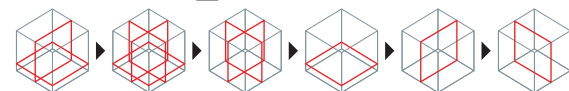

Levelling locked

For tilt applications



**Full 360-degree line is created by letting the laser from a light source reflect on a con mirror.**

- Rotary base with eccentric rotation mechanism reduces setup time.
- Vertical laser lines can rotate around the defined plumb point up to 10° left and right (with a dial for fine adjustment).
- Eccentric rotation mechanism enables the laser body to rotate without changing the position of the defined plumb point, enabling easy line positioning.

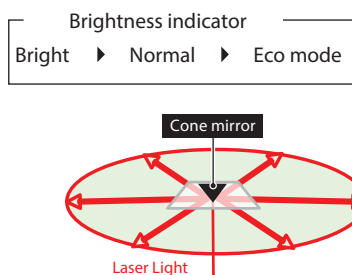

Measuring range	Up to: 35 m
Measuring range w/ detector	Up to: 70 m
Leveling accuracy	±2 mm / 10 m
Self-leveling range	±4°
Laser type	Laser class 2: 510 - 530 nm
Operating Temperature	-10 - 50°C
Protection class	IP54
Continuous Runtime (Approx. Hours)	14 hours (with 4.0Ah battery)
Dimensions (L x W x H)	w/ BL1041B: 168 x 104 x 153 mm
Net weight	1.2 kg

**Standard Equipment:** Target Plate, Adapter, Soft Bag

**AVAILABLE VARIANTS**

**"Z" Version**

**SK700D Z**  
TOOL ONLY  
(DOES NOT INCLUDE BATTERY / CHARGER OR CARRY CASE)

**Optional AA battery pack ADP09 (for SK40GD, SK700GD, SK700D)**



Available as an emergency power source when the capacity of CXT battery runs out. Able to supply power directly from the CXT battery port by using ADP09 with 8 nos of AA batteries

**SK106GD** 12V MAX | **CXT**

**Rechargeable 4-point Cross Line Laser**

**GREEN**

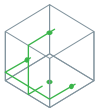
**Bright 525nm class II green laser with measuring range upto 35m and with ±3mm / 10m for best-in-class accuracy**

- High brightness green laser for increased visibility at bright site
- External Power Supply Jack for LXT Battery Use
- Line visibility range up to 35 m / 80 m (with Receiver)
- Pendulum lock enables slope incline applications for increased versatility; Offers added protection of laser diode during transport and storage

Measuring range	Up to: 35 m
Measuring range w/ detector	Up to: 80 m
Leveling accuracy	±3 mm / 10 m
Self-leveling range	±4°
Laser fan angle	Horizontal: 180° / Vertical: 170°
Number of laser points / Lines	4 / 2
Laser type	Laser class 2: 525 nm
Operating temperature	-10 - 50 °C
Operating Time (Approx. Hours)	7 - 20hrs
Dimensions (L x W x H)	138x64x102 mm (with 2.0Ah battery)
Net weight	0.48kg (without battery)

**Standard Equipment:** Soft bag, Adapter, Target Plate

AVAILABLE VARIANTS

**"Z" Version**

**SK106GD Z**  
TOOL ONLY  
(DOES NOT INCLUDE BATTERY / CHARGER OR CARRY CASE)

**SK106D** 12V MAX | **CXT**

**Rechargeable 4-point Cross Line Laser**

**RED**

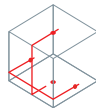
**Bright 635nm class II red laser with measuring range upto 25m and with ±3mm / 10m for best-in-class accuracy**

- External Power Supply Jack for LXT Battery Use
- Line visibility range up to 35 m / 80 m (with Receiver)
- Pendulum lock enables slope incline applications for increased versatility; Offers added protection of laser diode during transport and storage

Measuring range	Up to: 25 m
Measuring range w/ detector	Up to: 80 m
Leveling accuracy	±3 mm / 10 m
Self-leveling range	±4°
Laser fan angle	Horizontal: 180° / Vertical: 170°
Number of laser points / Lines	4 / 2
Laser type	Laser class 2: 635nm
Operating temperature	-10 - 50 °C
Operating Time (Approx. Hours)	15 - 40hrs
Dimensions (L x W x H)	138x64x102 mm (with 2.0Ah battery)
Net weight	0.48kg (without battery)

**Standard Equipment:** Soft bag, Adapter, Target Plate

AVAILABLE VARIANTS



**"Z" Version**

**SK106D Z**  
TOOL ONLY  
(DOES NOT INCLUDE BATTERY / CHARGER OR CARRY CASE)

**SK105GD** 12V MAX | **CXT**

**Rechargeable Cross Line Laser**

**GREEN**

**Bright 525nm class II green laser with measuring range upto 35m and with ±3mm / 10m for best-in-class accuracy**

- High brightness green laser for increased visibility at bright site
- External Power Supply Jack for LXT Battery Use
- Line visibility range up to 35 m / 80 m (with Receiver)
- Pendulum lock enables slope incline applications for increased versatility; Offers added protection of laser diode during transport and storage

Measuring range	Up to: 35 m
Measuring range w/ detector	Up to: 80 m
Leveling accuracy	±3 mm / 10 m
Self-leveling range	±4°
Laser fan angle	Horizontal: 180° / Vertical: 160°
Number of laser lines	2
Laser type	Laser class 2: 525 nm
Operating temperature	-10 - 50 °C
Operating Time (Approx. Hours)	7 - 20hrs
Dimensions (L x W x H)	138x64x102 mm (with 2.0Ah battery)
Net weight	0.46 kg (without battery)

**Standard Equipment:** Soft bag, Adapter, Target Plate

AVAILABLE VARIANTS

**"Z" Version**

**SK105GD Z**  
TOOL ONLY  
(DOES NOT INCLUDE BATTERY / CHARGER OR CARRY CASE)

**SK105D** 12V MAX | **CXT**

**Rechargeable Cross Line Laser**

**RED**

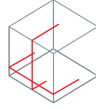
**Bright 635nm class II red laser with measuring range upto 25m and with ±3mm / 10m for best-in-class accuracy**

- External Power Supply Jack for LXT Battery Use
- Line visibility range up to 35 m / 80 m (with Receiver)
- Pendulum lock enables slope incline applications for increased versatility; Offers added protection of laser diode during transport and storage

Measuring range	Up to: 25 m
Measuring range w/ detector	Up to: 80 m
Leveling accuracy	±3 mm / 10 m
Self-leveling range	±4°
Laser fan angle	Horizontal: 180° / Vertical: 160°
Number of laser lines	2
Laser type	Laser class 2: 635nm
Operating temperature	-10 - 50 °C
Operating Time (Approx. Hours)	15 - 40hrs
Dimensions (L x W x H)	138x64x102 mm (with 2.0Ah battery)
Net weight	0.46 kg (without battery)

**Standard Equipment:** Soft bag, Adapter, Target Plate

AVAILABLE VARIANTS

**"Z" Version**

**SK105D Z**  
TOOL ONLY  
(DOES NOT INCLUDE BATTERY / CHARGER OR CARRY CASE)

- DRILLING / FIXING
- CONCRETE DRILLING / DEMOLITION
- MIXING / STIRRING
- CUTTING (CONCRETE / METAL)
- GRINDING
- SANDING / POLISHING
- SAWING
- MULTI-TOOL
- ROUTERS / PLANERS
- NAILERS / STAPLERS
- HEAT GUN / LASER
- CLEANING
- OPE
- JOB SITE TOOLS
- SPECIALTY TOOLS
- HAND TOOLS / COMBINATION SET
- TOOL HOLDERS AND POUCHES / MAKPAC SYSTEM

DRILLING /  
FIXING

CONCRETE  
DRILLING /  
DEMOLITION

MIXING /  
STIRRING

CUTTING  
(CONCRETE /  
METAL)

GRINDING

SANDING /  
POLISHING

SAWING

MULTI-TOOL

ROUTERS /  
PLANERS

NAILERS /  
STAPLERS

HEAT GUN /  
LASER

CLEANING

OPE

JOBSITE  
TOOLS

SPECIALTY  
TOOLS

HAND TOOLS /  
COMBINATION SET

TOOL HOLDERS  
AND POUCHES /  
MAKPAC SYSTEM

## Makita LD050P and LD080PI

These compact and handy models are specifically designed for indoor applications. Shortcut keys for addition, subtraction, area and volume calculation make measuring fast and very reliable. The last 5 or 20 measurements are also automatically stored depending on model. The laser dot is clearly visible. You can always see your targeting point, even if the target object is in a hard to access area.



### Robust End Piece

The LD080P and LD080PI end pieces are strong and rugged, offering excellent support when measuring from corners or edges. Position 1 offers a solid piece to butt up against edges, while position 2 provides ultimate accuracy when measuring from corners.



### Swiss Built Optics

Swiss precision optics and a sturdy titanium inner housing have been used in all models in order to give clear focusing of the laser over long distances, resistance to wear and tear on the building site and temperature change.

## Explanations

Typical Measuring Accuracy	2.0mm	1.5mm
Single Distance	●	● <b>80m</b> ●
Max / Min Distance	●	●
Add / Subtract	●	●
Area Calculation	●	●
Volume Calculation	●	●
Tracking Function	●	●
Pythagoras (2 point) - A	●	●
Pythagoras (3 point) - B	●	●
Partial Height - C	● <b>50m</b> ●	●
Timer Function		●
Corner Measuring Pin		●
Memory	5	20
Incline Measurement - D		●
Height Tracking		●
Stake Out		●



## LD050P

### Laser Distance Measure



### Compact, handy, and accurate

- New angle measuring method

Measuring Range	0.05m-50m
Power supply	Cell battery : AAA 15V x 2pcs
Net weight	0.1kg (0.22lbs)

Standard Equipment: Alkaline battery x2, Carrying strap, Target plate

## LD080PI

### Laser Distance Measure



### Compact, handy, and accurate

- New angle measuring method
- With inclination sensor

Measuring Range	0.05m-80m
Power supply	Cell battery : AAA 15V x 2pcs
Net weight	0.14kg (0.31lbs)

Standard Equipment: Alkaline battery x2, Carrying strap, Target plate



**LD030P****Laser Distance Measure****Compact, handy and specially designed for indoor applications**

- Laser dot clearly visible up to 30M
- Functions: Single Measurement
- Tracking function
- Area calculation

**3 Mode**

**Single measurement** **ON**

**Tracking function** **ON** 2sec.

**Area calculation** **UNIT**

Quick & easy automatic area calculation.

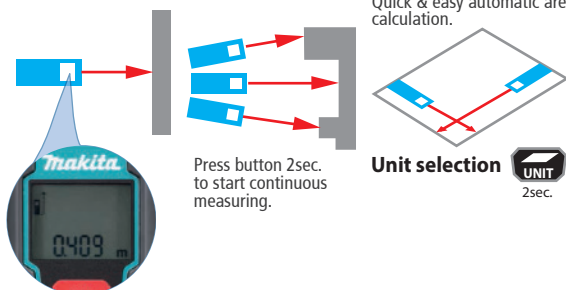

Press button 2sec. to start continuous measuring.

**Unit selection** **UNIT** 2sec.

**Precise measurement**

**Measuring Range**  
**0.2 - 30m**

**Protection Class**  
**IP54**

<b>Measuring Range</b>	0.2 - 30 m
<b>Storage temperature range</b>	-25 - 70 degrees
<b>Typical measuring tolerance</b>	±2.0mm / 10m
<b>Max measuring tolerance</b>	±3.0mm / 10m
<b>Diameter of laser point</b>	6mm / 10m
<b>Laser type</b>	(Laser class 2) : 635nm
<b>Dimensions (H x D x W)</b>	115x53x25mm (4-1/2"x2-1/16"x1")
<b>Net weight</b>	0.09kg

**Standard Equipment:** AAA 2x1.5V batteries

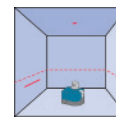
**SKR301****Rotating Laser Level****Automatic operation in both horizontal and vertical modes**

- Superior leveling range. • Choice of beams : spot, chalk line or Plumb line.
- Variable rotation speed.

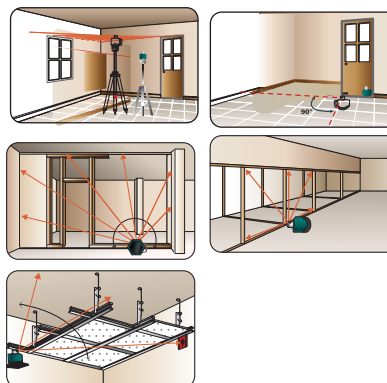

<b>Measuring range</b>	15m
<b>Measuring range with detector</b>	30m
<b>Rotation Speed</b>	0-535rpm
<b>Leveling accuracy</b>	+ - 10mm / 100m
<b>Leveling range</b>	+ - 8°
<b>Power supply</b>	Cell battery : 2pcs
<b>Operating time (approx. hrs)</b>	160

**Standard Equipment:** Remote control, CB60 Magnetic Target, Laser Intensive Glasses, Rechargeable (Ni-Cd) 2D Alkaline x 2 and Charger

**SKR200Z****Automatic Self-Leveling Laser Level****Automatic operation in both horizontal and vertical modes**

- SKR200Z has three rotation speeds, fast electronic self levelling, variable scanning, spot mode, manual slope capabilities and H.I alert system.
- SKR200Z for a wide range of applications ideal for general construction site levelling, plumb and squaring, drywall installation and drop ceilings.
- The SKR200Z is accurate to +-1mm at 10m making it a brilliant investment for anyone who is looking for a complete laser solution.



<b>Operating range</b>	Rotating beam (diameter): 200 m Plumb beam (up to): 30 m
<b>Rotation Speed (rpm)</b>	0, 300, 450, 600
<b>Leveling accuracy</b>	1 mm / 10 m
<b>Leveling range</b>	6°
<b>Operating Time (Approx. Hours)</b>	60
<b>Power supply</b>	Cell battery: 2 pcs
<b>Net weight</b>	1.6 kg

**Standard Equipment:** Remote controller, Wall Mount Bracket, Receiver

DRILLING / FIXING

CONCRETE DRILLING / DEMOLITION

MIXING / STIRRING

CUTTING (CONCRETE / METAL)

GRINDING

SANDING / POLISHING

SAWING

MULTI-TOOL

ROUTERS / PLANERS

NAILERS / STAPLERS

HEAT GUN / LASER

CLEANING

OPE

JOBSITE TOOLS

SPECIALTY TOOLS

HAND TOOLS / COMBINATION SET

TOOL HOLDERS AND POUCHES / MAKPAC SYSTEM

## Laser Accessories

DRILLING / FIXING

CONCRETE DRILLING / DEMOLITION

MIXING / STIRRING

CUTTING (CONCRETE / METAL)

GRINDING

SANDING / POLISHING

SAWING

MULTI-TOOL

ROUTERS / PLANERS

NAILERS / STAPLERS

HEAT GUN / LASER

CLEANING

OPE

JOBSITE TOOLS

SPECIALTY TOOLS

HAND TOOLS / COMBINATION SET

TOOL HOLDERS AND POUCHES / MAKPAC SYSTEM

### Tripod

(Aluminium)



Type	Max Height	Part No.
Standard Tripod - Flat head	1.65m	<span style="color: red;">■</span> P-81088
Tripod with Elevating Column	2.7m	P-81315
SK312GD, SK700GD, SK700D, SK106D/GD, SK105D/GD	0.4 - 1.1m	TK0LM2000F
	0.6 - 1.8m	TK0LM4001F
	0.7 - 2.9m	TK0LM5030F

### Aluminium Scale Rod



Description	Size	Part No.
Aluminium Rod	4m	P-46414

### Laser Detectors



For Model		Detecting distance (feet)	Part No.
SK106D/GD, SK105D/GD, SK700D/GD	LDX1	262f	LE00855702
SK312GD	LDX3	65f	TK0LDG301F
SK40GD, SK312GD	LDX5	65f	TK0LDG501G
SKR301	LD150A		P-67876

### Wall mount

With fine adjustment



For Model	Type	Part No.
SK312GD	a	TK000ET03F
SK312GD, SK40GD	a	TK00ET03F1
SK700DGD, SK106D/GD, SK105D/GD	b	LE00870137

### Power supply cable

Helps to connects the Laser and the adpater ADP05



For Model	Part No.
SK312GD	199006-4
SK106GD, SK106D, SK105GD, SK105D	199178-5

### Hand strap set



For Model	Part No.
SK312GD	199007-2

### Magnetic Target for SKR301

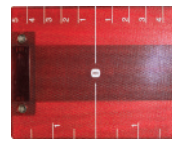

Type	Part No.
CB60 Magnetic Target	P-66531

### ADP09 - Adapter / AA Battery Pack



**Model ADP09 is an AA battery pack designed to supply power to the CXT Lasers**

- Adapts AA Batteries to be used a power source
- Uses 8 x AA Batteries to power compatible 12Vmax CXT lasers SK700GD, SK700D, SK40GD

(ADP09 does not includes AA batteries)

# Cleaning

Vacuum Cleaners, Backpack Vacuum Cleaners, Upright Cleaner, Robotic Cleaner, Stick Type Cleaners, High Pressure Washer



# Growing Concern About Dust Hazards to Health

Recently more and more people are showing their stronger interest in hazards dusts which may cause the sickness of the nose, throat, lungs and skin. Some fine dust may cause lung cancer once accumulated inside the body.

## Dust classes in accordance with the EU standard

Since 1997, hazardous dusts have been categorized into 3 ( three ) classes, namely, Class L, Class M and Class H, which is regulated by IEC69-2-60335 ( world wide ) and by EN 69-2-60335. The vacuum cleaners suitable for each of dust class have been also defined by these regulations as follows :

Dust class	Requirement	Dust permeability (Permeability of limestone (marble) particles having a diameter of 5 microns or less,
<b>H</b> VC3211H	Air flow sensor Filter protection structure (Note:-Filters should be protected from sharp objects such as nails when they are accidentally sucked up) Structure that requires a tool for filter removal / installation (Filters loaded with dust should not be easily removed.) Structure that protects users from exposure to dust when emptying dust bag (Dust should be prevented from flying around when emptying dust bags or replacing filters)	Less than 0.005%
<b>L</b> DVC750L, DVC864L, DVC860, DVC157L, DVC154L, DVC150L, VC3210L, VC2000L, VC003GL, VC004GL, VC005GL, VC007GL	-	Less than 1%

## HEPA filter





"HEPA" is widely recognized as one of famous guidelines of the filtration efficiency.

According to EU standard, the filter of "HEPA" should remove more than 99.97% of airborne particles of 0.3µm in diameter. Thus, it stipulates only a filtration efficiency of the filter itself, while IEC/EN69-2-60335 defines the vacuum machine suitable for each dust class (construction, mechanical strength of machine) as well as its dust permeability.

In this sense, Dust Class H vacuum cleaner does not always have to be equipped with HEPA filter as long as it meets the requirements of IEC/EN69-2-60335.

Another difference between HEPA testing methods and the IEC/EN69-2-60335 is the dust loading. Filter elements for dust classes M and H are to be tested with the limestone dust particles in large quantities for checking the physical strength of filter, while HEPA tests are done with very small liquid droplets.

## VACUUM CLEANERS (DRUM TYPE)

											
	VC007GL	VC004GL	VC003GL	VC005GL	DVC157L DVC154L	DVC150L	DVC864L	DVC860L	VC3211HX1	VC3210LX1	VC2000L
AC/DC	DC	DC	DC	DC	DC	AC + DC	DC	AC + DC	AC	AC	AC
PARALLEL BATTERY		✓	✓	✓							
BL MOTOR	✓	✓	✓	✓	✓		✓		✓	✓	
AUTOMATIC SELF CLEANING SYSTEM	✓	✓			✓		✓		✓	✓	
AUTO START WIRELESS SYSTEM	✓	✓			✓		✓				
DUST CAPACITY (WET & DRY)	40L DRY 30L WET	15L DRY	15L DRY 12L WET	8L DRY	15L DRY	15L DRY 12L WET	8L DRY	8L DRY 6L WET	32L DRY 27L WET	32L DRY 27L WET	20L DRY 13L WET

\*with optional AWS adapter WUTO2



FOR USED WITH POWER TOOL TO EXTRACT DUST



FOR CLEANING

# DRUM TYPE CORDLESS VACUUM CLEANER

## HIGH SUCTION POWER

Brushless motor provide higher suction power

## AUTOMATIC SELF-CLEANING SYSTEM

When the power is switched on, Prefilter collapses into itself to compress damper and fits closely over damper and powder filter. When the power is switched off, damper expands back to its original size and shakes off dust from prefilter automatically with its expanding power.

### Efficient three stage HEPA filtration system

Captures 99.97% of particles 0.3 microns and larger



STRUCTURE :  
VC004GL, DVC157L, DVC154L, DVC184L



STRUCTURE :  
VC007GL (twin filter)

## AUTO START WIRELESS SYSTEM (AWS)



AWS Dust Extractor connects wirelessly with the power tool and allows the dust extractor to start automatically when the tool starts. Also dust extractor stops on its own when the tool is in rest

Wireless unit slot allows to insert Bluetooth chip that communicates between tool and dust extractor for on/off function (198900-7)

## LONGER RUN TIME WITH TWO PARALLEL BATTERY

Runs with two batteries in parallel (Only for models VC005GL, VC004GL, VC003GL)

Vacuum Cleaner adapts two XGT battery that works parallel. Cleaner automatically switches to the second battery when the first battery runs out



## AC / DC - DUAL POWER SOURCE (Only for models DVC150L / DVC860L)

Versatile Use: Thanks to 2 different Power Sources provides easy maneuverability anywhere you need cleaning



DRILLING / FIXING

CONCRETE DRILLING / DEMOLITION

MIXING / STIRRING

CUTTING (CONCRETE / METAL)

GRINDING

SANDING / POLISHING

SAWING

MULTI-TOOL

ROUTERS / PLANERS

NAILERS / STAPLERS

HEAT GUN / LASER

CLEANING

OPE









JOB SITE TOOLS

SPECIALTY TOOLS

HAND TOOLS / COMBINATION SET

TOOL HOLDERS AND POUCHES / MAKPAC SYSTEM

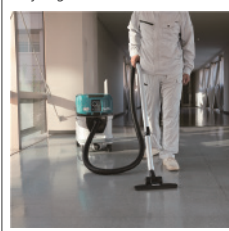
## XGT VACUUM CLEANERS

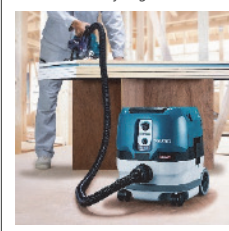
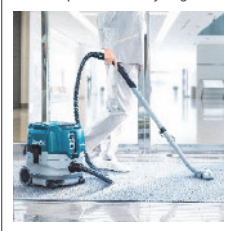
	VC007GL 80V(40V+40V) MAX   XGT	VC003GL 40V MAX   XGT	VC004GL 40V MAX   XGT	VC005GL 40V MAX   XGT
				
	<b>40L/30L</b> WET/DRY (AWS)	<b>15L/12L</b> WET/DRY	<b>15L</b> DRY(AWS)	<b>8L</b> DRY
				
	<b>80V MAX BL XPT AWS</b>	<b>40V MAX BL XPT</b>	<b>40V MAX BL XPT AWS</b>	<b>40V MAX BL XPT</b>
	Type: Wet / Dry (AWS) Filter Type: HEPA + GYUPPA	Type: Wet / Dry Filter Type: Cloth Filter	Type: Dry (AWS) Filter Type: HEPA + GYUPPA	Type: Dry Filter Type: Filter cage + Cloth filter
	Tank Capacity (dry / wet): 40L / 30L	Tank Capacity (dry / wet): 15L / 12L	Tank Capacity (dry / wet): 15L	Tank Capacity (dry / wet): 8L
	Continuous Use (min.) (aprox.): 25-80 min. (5.0Ah x 2)	Continuous Use (min.) (aprox.): 28-220 min. (5.0Ah x 2 parallel)	Continuous Use (min.) (aprox.): 28-220 min. (5.0Ah x 2 parallel)	Continuous Use (min.) (aprox.): 28-220 min. (5.0Ah x 2 parallel)
	Max Suction Power: High: 350W	Max Suction Power: High: 310W	Max Suction Power: High: 205W	Max Suction Power: High: 265W
	Max Air Flow: 3.7 m³/min	Max Air Flow: 3.2 m³/min	Max Air Flow: 1.8 m³/min	Max Air Flow: 2.8 m³/min
	Max Sealed Suction: 18 kPa	Max Sealed Suction: 23 kPa	Max Sealed Suction: 23 kPa	Max Sealed Suction: 23 kPa
	Noise (dB): 69 dB(A)	Noise (dB): 67 dB(A)	Noise (dB): 67dB(A)	Noise (dB): 66dB(A)
	Dimensions (L x W x H): 586x385x598 mm	Dimensions (L x W x H): 366x334x475 mm	Dimensions (L x W x H): 366x334x475 mm	Dimensions (L x W x H): 366x334x397 mm
	Net weight (without battery): 17.6 kg	Net weight (without battery): 8.9 kg	Net weight (without battery): 9.1 kg	Net weight (without battery): 8.4 kg
	AVAILABLE VARIANT	AVAILABLE VARIANT	AVAILABLE VARIANT	AVAILABLE VARIANT
	"Z" VARIANT	"Z" VARIANT	"Z" VARIANT	"Z" VARIANT
	<b>VC007G LZ</b> TOOL ONLY (DOES NOT INCLUDE BATTERY / CHARGER) Standard Equipments: Straight pipe, Bend pipe, Hoses 38-2.5m, front cuffs, Corner nozzle, Floor nozzle, Poly Bag Set	<b>VC003G LZ</b> TOOL ONLY (DOES NOT INCLUDE BATTERY / CHARGER) Standard Equipments: Telescopic pipe assembly, Bent Pipe, Hose 32-1.7m, Corner nozzle, Floor-Carpet nozzle, Poly Bag Set	<b>VC004G LZ</b> TOOL ONLY (DOES NOT INCLUDE BATTERY / CHARGER) Standard Equipments: Straight pipe, Bend pipe, Hoses 38-2.5m, & 28-3.5m, front cuffs, Corner nozzle, Floor nozzle, Poly Bag Set	<b>VC005G LZ</b> TOOL ONLY (DOES NOT INCLUDE BATTERY / CHARGER) Standard Equipments: Telescopic pipe assembly, Bent Pipe, Hose 32-1.7m, Corner nozzle, Floor-Carpet nozzle, Poly Bag Set
				





Suction Power, Air flow, sealed suction are with ø38 x 2.5m hose

## LXT VACUUM CLEANERS (WITH AWS) (recommended for dust collecting with power tools)

	DVC157L 18Vx2 LXT	DVC154L 18Vx2 LXT	DVC864L 18Vx2 LXT
			
	<b>15L</b> DRY(AWS)	<b>15L</b> DRY(AWS)	<b>8L</b> DRY(AWS)
			
	<b>36V LXT BL AWS XPT</b>	<b>36V LXT BL AWS XPT</b>	<b>36V LXT BL AWS XPT</b>
	AWS: Yes	AWS: Yes (In-built)	AWS: Yes (In-built)
	Dust: 15 L	Dust: 15 L	Dust: 8 L
	Continuous Use (min.) (aprox.): With 2 x BL1860B: 40-100	Continuous Use (min.) (aprox.): With 2 x BL1860B: 50-120	Continuous Use (min.) (aprox.): With 2 x BL1860B: 50-120
	Max Suction Power: High: 110 - 40 W	Max Suction Power: High: 90 - 25 W	Max Suction Power: High: 90 - 25 W
	Max Air Flow: 2.1 m³/min	Max Air Flow: 2.1 m³/min	Max Air Flow: 2.1 m³/min
	Max Sealed Suction: 11 - 5.3 kPa	Max Sealed Suction: 9.8 - 4.4 kPa	Max Sealed Suction: 9.8 - 4.4 kPa
	Noise (dB): 64-57 dB(A)	Noise (dB): 65-66 dB(A)	Noise (dB): 65-66 dB(A)
	Dimensions (L x W x H): 366x334x368 mm	Dimensions (L x W x H): 366x334x421 mm	Dimensions (L x W x H): 366x334x368 mm
	Net weight: 8.4 kg	Net weight: 8.6 kg	Net weight: 8.4 kg
	AVAILABLE VARIANT	AVAILABLE VARIANT	AVAILABLE VARIANT
	"Z" VARIANT	"Z" VARIANT	"Z" VARIANT
	<b>DVC157 LZ</b> TOOL ONLY (DOES NOT INCLUDE BATTERY / CHARGER)	<b>DVC154 LZ</b> TOOL ONLY (DOES NOT INCLUDE BATTERY / CHARGER)	<b>DVC864 LZ</b> TOOL ONLY (DOES NOT INCLUDE BATTERY / CHARGER)

Standard Equipments: Front Cuffs, 28mm Dia - 3.5m Hose, Hepa Filter Set, Polybag Set. (Specifications are with ø38 x 2.5m hose) (without straight pipe and nozzle assembly)

# LXT VACUUM CLEANERS (WET/DRY) (AC/DC)

	DVC150L 18Vx2 LXT	DVC860L 18Vx2 LXT
		
	15L/12L WET/DRY	8L/6L WET/DRY
		
<b>Type</b>	Wet / Dry	Wet / Dry
<b>Filter Type</b>	Cloth Filter	Cloth Filter
<b>Tank Capacity</b>	15 / 12 L	8 / 6 L
<b>Continuous Use (min.) (approx.)</b>	30-65 min. (with BL1850B x 2)	30-65 min. (with BL1850B x 2)
<b>Max Suction Power</b>	AC / DC: 320 / 70 W	AC / DC: 320 / 70 W
<b>Max Air Flow</b>	AC / DC: 3.6 / 2.1 m³/min	AC / DC: 3.6 / 2.1 m³/min
<b>Max Sealed Suction</b>	AC / DC: 24 / 9 kPa	AC / DC: 24 / 9 kPa
<b>Noise (dB)</b>	AC / DC: 75 / 64 dB(A)	AC / DC: 75 / 64 dB(A)
<b>Dimensions (L x W x H)</b>	366x334x421 mm	366x334x368 mm
<b>Net weight (without battery)</b>	8.2 kg	7.8 kg
	<b>AVAILABLE VARIANT</b> "Z" VARIANT	<b>AVAILABLE VARIANT</b> "Z" VARIANT
	<b>DVC150 LZ</b> TOOL ONLY (DOES NOT INCLUDE BATTERY / CHARGER)	<b>DVC860 LZ</b> TOOL ONLY (DOES NOT INCLUDE BATTERY / CHARGER)
	Standard Equipments: Floor Nozzle, Corner Nozzle, Bend pipe, Straight Pipe, 38mm Dia - 2.5m Hose, Cloth Filter, Poly Bag Set (Suction Power, Air flow, sealed suction are with ø38 x 2.5m hose)	

## VC2000L

### Vacuum Cleaner (Wet & Dry)



**20 L "Dust Class L" Vacuum Cleaner (Wet & Dry)**

- Class L - Removes 99.0% of dust with limit value for occupational exposure >1.0mg/m3
- Suitable for processes involving mica, china clay, gypsum.
- Push & Clean semi-automatic filter cleaning system for extended operating time and filter life
- Convenient integrated carry handle for easier transportation
- Designed for domestic and commercial vacuum cleaning
- Double Insulation



<b>Continuous rating Input</b>	1,000W
<b>Max. peak air flow</b>	3.6 m³/min
<b>Max. sealed suction</b>	21.0 kPa
<b>Tank capacity</b>	Dust : 20L / Water : 13L
<b>Noise sound pressure</b>	72 dB(A)
<b>Hose length</b>	3.5 m
<b>Hose Diameter</b>	32mm
<b>Dimensions (L x W x H)</b>	390x385x505 mm
<b>Net weight</b>	7.5kg
<b>Power supply cord</b>	5.0m

**Standard Equipment:** Hose, Straight Pipes, Nozzle Assembly

## WUT02 (part # 199838-9)

### Auto-Start Wireless Universal Adapter



- WUT02 adapter converts our VC3210LX1 and VC3211HX1 vacuum cleaners compatible with our AWS powered tools by connecting the adapter with on-board AC outlet of the vacuum cleaners



WUT02 - Auto-Start Wireless Adapter connected with AC outlet of the cleaner

**Compatible with Makita AC outlet Cleaners VC3210LX1 / VC3211HX1**

WUT02 is a universal adapter therefore it also converts some of the other branded AC Cleaners (with on-board AC outlet) compatible with our AWS powered tools



Channel setting button is used to test the successful pairing of the tool and extractor

Caution Lamp lights up red if adapter is overheating or other malfunction occurs

Wireless unit slot  
Wireless unit Part#: 198900-7 (optional)

- DRILLING / FIXING
- CONCRETE DRILLING / DEMOLITION
- MIXING / STIRRING
- CUTTING (CONCRETE / METAL)
- GRINDING
- SANDING / POLISHING
- SAWING
- MULTI-TOOL
- ROUTERS / PLANERS
- NAILERS / STAPLERS
- HEAT GUN / LASER
- CLEANING
- OPE
- JOB SITE TOOLS
- SPECIALTY TOOLS
- HAND TOOLS / COMBINATION SET
- TOOL HOLDERS AND POUCHES / MAKPAC SYSTEM

DRILLING /  
FIXING

CONCRETE  
DRILLING /  
DEMOLITION

MIXING /  
STIRRING

CUTTING  
(CONCRETE /  
METAL)

GRINDING

SANDING /  
POLISHING

SAWING

MULTI-TOOL

ROUTERS /  
PLANERS

NAILERS /  
STAPLERS

HEAT GUN /  
LASER

CLEANING

OPE

JOBSITE  
TOOLS

SPECIALTY  
TOOLS

HAND TOOLS /  
COMBINATION SET

TOOL HOLDERS  
AND POUCHES /  
MAKPAC SYSTEM

## VC3211HX1



### Vacuum Cleaner (Wet & Dry)



**GYUPPA!**

#### 32 L "Dust Class H" GYUPPA Vacuum Cleaner (Wet & Dry)

- High maneuverability and easy mobility thanks to 32 Liter compact stainless steel tank
- Best suitable for working with power tools

### Automatic Self-cleaning Filtration System achieved by two filter units

Constantly high suction power throughout operation because dust is removed from Prefilters every 10 seconds during operation.



#### Specifications:-



Continuous rating input	1,050W
Max peak air flow	2.0 m <sup>3</sup> / min
Max Sealed Suction (water column)	22.0 kPa
Tank capacity	Dust : 32 L Water : 27 L
Dimensions (L x W x H)	552x398x685 mm
Net weight	16.9 kg
Power supply cord	5.0 m

**Standard Equipment:** Hose, Front Cuffs (38 ,24 ,22), Belt Hook, Hose Band, Cap, Poly bag set

## VC3210LX1



### Vacuum Cleaner (Wet & Dry)



**GYUPPA!**

#### 32 L "Dust Class L" GYUPPA Vacuum Cleaner (Wet & Dry)

- High maneuverability and easy mobility thanks to 32 Liter compact stainless steel tank
- Best suitable for working with power tools

### Automatic self-cleaning filter obtained by Triple filter structure composed of:

#### Powder filter + Damper + Prefilter

Constantly high suction power  
Easy filter cleaning simply by tapping dust off of Prefilter  
Quiet cleaning because Damper and Prefilter make no noise

When the power is switched on, Prefilter collapses into itself to compress Damper, and fits closely over Damper and Powder filter.

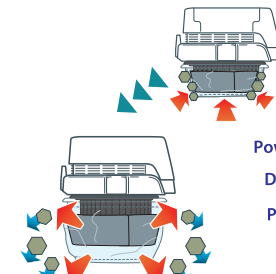

When the power is switched off, Damper expands back to its original size and shakes off dust from Prefilter automatically with its expanding power.



Allows for:

#### Constantly high suction power

Easy filter cleaning simply by tapping dust off of Prefilter

Quiet cleaning because Damper and Prefilter make no noise

#### Specifications:-



Continuous rating Input	1,050W
Max. peak air flow	2.0m <sup>3</sup> / min
Max. sealed suction (water column)	22.0kPa
Tank capacity	Dust : 32L Water : 27L
Overall height	552x398x685mm
Net weight	14.5kg
Power supply cord	5.0m

**Standard Equipment:** Hose, Front Cuffs (38 ,24 ,22), Holder 33-10, Bending pipe, Straight pipe, Nozzle assembly, Poly bag set



# XGT BACKPACK VACUUM CLEANERS

Combination of XGT battery and brushless motor provide higher suction power

**Efficient two stage HEPA filtration system**  
Captures 99.97% of particulates, 0.3 microns and larger

Improved switch that allows you to check the remaining battery capacity and the operating mode

**AWS** Bluetooth   
**Auto Wireless Start Function**  
Dust extractor connects the power tool via bluetooth for efficient cleaning (only for VC009G)



DRILLING / FIXING

CONCRETE DRILLING / DEMOLITION

MIXING / STIRRING

CUTTING (CONCRETE / METAL)

GRINDING

SANDING / POLISHING

SAWING

MULTI-TOOL

ROUTERS / PLANERS

NAILERS / STAPLERS

HEAT GUN / LASER

CLEANING

OPE

JOB SITE TOOLS

SPECIALTY TOOLS

HAND TOOLS / COMBINATION SET

TOOL HOLDERS AND POUCHES / MAKPAC SYSTEM

## VC009G 40V MAX | XGT

### Cordless Backpack Vacuum Cleaner (AWS)

Recommended for dust collecting with power tools



Combination of XGT battery and brushless motor provide higher suction power but with quiet operation

- Auto-Start Wireless System (AWS) connects to AWS-enabled tools via Bluetooth
- HEPA filter to effectively capture very fine particles
- It has an improved switch that allows you to check the remaining battery capacity and the operating mode.
- 3 suction power modes with mode memory function



Capacity	Cloth Dust Bag: 2 / 1.5 L
Max Air Flow	1.9 m³/min
Max Sealed Suction	18 kPa
Suction Power	with hose 28-1.5, Max / High / Normal : 165 / 85 / 45W
Dimensions (L x W x H)	233 x 151 x 376 mm
Net weight	3.6 kg (without battery)

**Standard Equipment:** Hose, Hose Band, Dust Bag, Front Cuff (without straight pipe and nozzle assembly)

AVAILABLE VARIANTS

"Z" VARIANT

**VC009G**  
TOOL ONLY  
(DOES NOT INCLUDE BATTERY / CHARGER / BLUETOOTH CHIP / CARRYING CASE)

## VC008G 40V MAX | XGT

### Cordless Backpack Vacuum Cleaner



Combination of XGT battery and brushless motor provide higher suction power but with quiet operation

- HEPA filter to effectively capture very fine particles
- It has an improved switch that allows you to check the remaining battery capacity and the operating mode. Built-in LED work light illuminates the work area
- With 4 different suction modes.
- Low noise mode allows for use in noise-sensitive environments such as office, hospital and more



Capacity	Cloth Dust Bag: 2 / 1.5 L
Max Air Flow	2.4 m³/min
Max Sealed Suction	18 kPa
Suction Power	with hose 32-1.0 (Max): 180 W
Dimensions (L x W x H)	233 x 151 x 376 mm
Net weight	3.6 kg (without battery)

**Standard Equipment:** Floor Nozzle, Hose, Hose Band, Telescopic pipe assembly, Bent Pipe, Switching nozzle Dust Bag

AVAILABLE VARIANTS

"Z" VARIANT

**VC008G**  
TOOL ONLY  
(DOES NOT INCLUDE BATTERY / CHARGER / CARRYING CASE)

DRILLING / FIXING

CONCRETE DRILLING / DEMOLITION

MIXING / STIRRING

CUTTING (CONCRETE / METAL)

GRINDING

SANDING / POLISHING

SAWING

MULTI-TOOL

ROUTERS / PLANERS

NAILERS / STAPLERS

HEAT GUN / LASER

CLEANING

OPE

JOBSITE TOOLS

SPECIALTY TOOLS

HAND TOOLS / COMBINATION SET

TOOL HOLDERS AND POUCHES / MAKAPAC SYSTEM

# LXT BACKPACK VACUUM CLEANERS

**Higher suction power with brushless motor**

**Efficient two stage HEPA filtration system**

Captures 99.97% of particulates, 0.3 microns and larger

Easily accessible side-loading batteries for added convenience (DVC660/ DVC665)

**Cleaning mechanism with paper dust bag (for DVC660)**

Dust that tending to clog filters actuated automatically due to vibration or pulling down the lever

**AWS Bluetooth**  
**Auto Wireless Start Function**

Dust extractor connects the power tool via bluetooth for efficient cleaning (DVC665 / DVC265)

## DVC665

18Vx2 LXT

### Cordless Backpack Vacuum Cleaner (AWS)

Recommended for dust collecting with power tools



<b>Capacity</b>	Paper dust b/ag: 6.0 L / Cloth dust bag: 5.5 L
<b>Continuous Use (min.)</b>	High / Normal: 40 / 75 (with BL1860B x2)
<b>Max Air Flow</b>	1.8 m³/min (28mm-1.5m Hose)
<b>Max Sealed Suction</b>	11 kPa
<b>Max Suction Power</b>	High / Normal: 85 / 45 W (28mm-1.5m Hose)
<b>Vibration Level</b>	Operation w/o Load: 2.5 m/s² or less
<b>Sound Pressure Level</b>	High: 66 / Normal: 62dB(A)
<b>Dimensions (L x W x H)</b>	297x174x523 mm
<b>Net weight</b>	6.7 kg

**Standard Equipment:** 28mm dia 1.5m hose, front cuff 22 ,38, Rubber joint 24, Paper bag (without straight pipe and nozzle assembly)

#### AVAILABLE VARIANTS

#### "Z" VARIANT

**DVC665 Z**  
TOOL ONLY (WITH BLUETOOTH CHIP)  
(DOES NOT INCLUDE BATTERY / CHARGER OR CARRY CASE)

## DVC265

18Vx2 LXT

### Cordless Backpack Vacuum Cleaner (AWS)

Recommended for dust collecting with power tools



<b>Capacity</b>	Paper Dust Bag: 2.0 L / Cloth Dust Bag: 1.5 L
<b>Continuous Use (min.)</b>	High: 40 / Low: 75 (with BL1860B)
<b>Max Air Flow</b>	1.8 m³/min (28mm-1.5m Hose)
<b>Max Sealed Suction</b>	11 kPa
<b>Suction Power</b>	High / Normal: 85 / 45 W (28mm-1.5m Hose)
<b>Vibration Level</b>	Operation without Load: 2.5 m/s² or less
<b>Sound Pressure Level</b>	High: 69 / Normal: 65dB(A)
<b>Dimensions (L x W x H)</b>	230x152x373 mm
<b>Net weight</b>	4.5 kg

**Standard Equipment:** 28mm dia 1.5m hose, front cuff 22 ,38, Rubber joint 24, Paper bag (without straight pipe and nozzle assembly)

#### AVAILABLE VARIANTS

#### "Z" VARIANT

**DVC265 ZXU**  
TOOL ONLY (WITH BLUETOOTH CHIP)  
(DOES NOT INCLUDE BATTERY / CHARGER OR CARRY CASE)

## DVC660

18Vx2 LXT

### Cordless Backpack Vacuum Cleaner



<b>Capacity</b>	Paper dust bag: 6.0 L / Cloth dust bag: 5.5 L
<b>Continuous Use (min.)</b>	Max: 40 / High:75 / Normal: 140 (with BL1860B x2)
<b>Max Air Flow</b>	2.2 m³/min (32mm-1m Hose)
<b>Max Sealed Suction</b>	11 kPa
<b>Max Suction Power</b>	Max / High / Normal: 95 / 50 / 25 W (32mm-1m Hose)
<b>Vibration Level</b>	Operation w/o Load: 2.5 m/s² or less
<b>Sound Pressure Level</b>	Max: 66 / High: 62 / Normal: 58 dB(A)
<b>Dimensions (L x W x H)</b>	297x174x523 mm
<b>Net weight</b>	6.7 kg

**Standard Equipment:** 32mm dia 1m hose, Floor Nozzle, Hose, Hose Band, Nozzle assembly, Telescopic pipe assembly, Bent Pipe, Seat nozzle, Round Brush, Flexible Nozzle, Dust Bag.

#### AVAILABLE VARIANTS

#### "Z" VARIANT

**DVC660 ZX8**  
TOOL ONLY  
(DOES NOT INCLUDE BATTERY / CHARGER OR CARRY CASE)

## DVC261

18Vx2 LXT

### Cordless Backpack Vacuum Cleaner



<b>Capacity</b>	Paper Dust Bag: 2.0 L / Cloth Dust Bag: 1.5 L
<b>Continuous Use (min.)</b>	Max: 40 / High: 75 / Normal: 140 (with BL1860Bx 2 )
<b>Max Air Flow</b>	2.0 m³/min (28mm-1m Hose)
<b>Max Sealed Suction</b>	11 kPa
<b>Suction Power</b>	Max / High / Normal : 90 / 45 / 25 W (28mm-1m Hose)
<b>Vibration Level</b>	Operation w/o Load: 2.5 m/s² or less
<b>Sound Pressure Level</b>	Max: 69 / High: 65 / Normal: 62 dB(A)
<b>Dimensions (L x W x H)</b>	230x152x373 mm
<b>Net weight</b>	4.5 kg

**Standard Equipment:** 28mm dia 1m hose, Floor Nozzle, Hose, Hose Band, Nozzle assembly, Telescopic pipe assembly, Bent Pipe, Flexible Nozzle, Dust Bag

#### AVAILABLE VARIANTS

#### "Z" VARIANT

**DVC261 ZX11**  
TOOL ONLY  
(DOES NOT INCLUDE BATTERY / CHARGER OR CARRY CASE)

**DVC560**
**18Vx2 LXT**

Cordless Upright Vacuum Cleaner



5L

90° range of operation for use at any angle and under furniture

**Cordless Upright Vacuum to provide both a rotating power brush for deep carpet cleaning & a detachable hand-wand for cleaning with the onboard accessories**

- 3 Stage power selection for optimum suction performance
- Low profile design allows access to more areas
- Compact and lightweight



5.0L Capacity disposable bags with high-grade filtration and a HEPA filter that captures up 99.97% of particles at 0.3 micron HEPA Filter (191E39-5)



- Hose Complete 28mm-0.7 (140S37-0)
- Pipe Assembly (127522-6)
- Long sash nozzle (191D65-8)
- Round brush (191D67-4)
- Disposable Bag 10-Pk (191D63-2)
- Re-usable dust bag (Optional) (191Y86-6)
- Replacement main brush (191D69-0)
- Caster Rubber wheels (140S28-1)

<b>Capacity</b>	5.0L
<b>Max. sealed suction</b>	12.0kPa
<b>Max. air volume</b>	1.9m³/min
<b>Working width</b>	318mm
<b>Max. airflow in Litres</b>	30L/sec
<b>Continuous Runtime (2 x 6.0Ah)</b>	H: 30 / N: 60 / L: 120 mins
<b>Overall length</b>	1,146 mm
<b>Net weight</b>	9.0 kg

**5.0Ah**

**DVC560 PT2**  
INCLUDES 2 BATTERIES / 1 TWO PORT CHARGER

**"Z" VARIANT**

**DVC560 Z**  
TOOL ONLY (WITH CARRY CASE)  
(DOES NOT INCLUDE BATTERY / CHARGER)

**DCL501**
**18V LXT**

Cordless Cyclone Cleaner

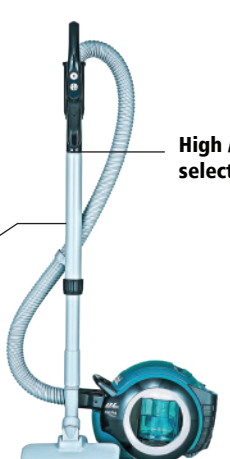

**Telescopic pipe**  
Can be extended to allow for grip height adjustment to suit users height.

**Warning lights**

1. Orange LED indicator for filter cleaning warning
2. Red LED indicator for battery capacity warning

**HEPA filter with high filtration capacity.**

**Advanced Filtration system with cyclone separation**



Cleaner has the advanced Cyclonic filtration system with HEPA filter collects large and small dust particles efficiently



**Easy dust disposal**



- Dust cup can be removed for easy dust disposal simply by pulling up the cup release lever then by pushing the release button
- The dust cup and the filter are washable in water

<b>Capacity</b>	250 mL
<b>Continuous Use (min.)</b>	High: 35 / Low: 77 (with BL1860B)
<b>Max Air Flow</b>	1.2 m³/min
<b>Max Sealed Suction</b>	10 kPa
<b>Dimensions (L x W x H)</b>	352x189x252 mm
<b>Net weight</b>	3.1 kg

**Standard Equipment:** Shoulder Belt, Crevice Nozzle, Cleaning Brush, Floor Nozzle, Telescopic Pipe, Hose, Hose Hook

**"Z" VARIANT**

**DCL501 Z**  
TOOL ONLY  
(DOES NOT INCLUDE BATTERY / CHARGER OR CARRY CASE)

**AVAILABLE VARIANTS**

- DRILLING / FIXING
- CONCRETE DRILLING / DEMOLITION
- MIXING / STIRRING
- CUTTING (CONCRETE / METAL)
- GRINDING
- SANDING / POLISHING
- SAWING
- MULTI-TOOL
- ROUTERS / PLANERS
- NAILERS / STAPLERS
- HEAT GUN / LASER
- CLEANING
- OPE
- JOBSITE TOOLS
- SPECIALTY TOOLS
- HAND TOOLS / COMBINATION SET
- TOOL HOLDERS AND POUCHES / MAKPAC SYSTEM

- DRILLING / FIXING
- CONCRETE DRILLING / DEMOLITION
- MIXING / STIRRING
- CUTTING (CONCRETE / METAL)
- GRINDING
- SANDING / POLISHING
- SAWING
- MULTI-TOOL
- ROUTERS / PLANERS
- NAILERS / STAPLERS
- HEAT GUN / LASER
- CLEANING
- OPE
- JOBBSITE TOOLS
- SPECIALTY TOOLS
- HAND TOOLS / COMBINATION SET
- TOOL HOLDERS AND POUCHES / MAKPAC SYSTEM

DRC300
18V | LXT

**Cordless Robotic Cleaner with mapping function**



**NEW**



Compatible with Smartphone app (Makita RoboPro DRC300)

### Large side brushes + Large power brush

Side brushes enable to clean alongside walls, around obstacles or tight corners in either of pattern/ random

Side Brush Part no: 191P28-6 (Brush for tatami mats: 191P26-0)

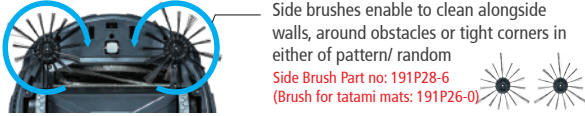

ø50mm x 260mm Large Power rotating brush

A: Main brush complete set Part no: 191P22-8  
 B: Main brush complete set Part no: 191P20-2  
 C: Bottom plate assembly set 191P24-4

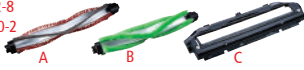

**Robotic cleaner for commercial/industrial use**

- Clean an area of 600m<sup>2</sup> per 240min, (coverage rate of 95%) (2 x BL1860B in parallel)
- Wireless remote controller

**Two navigation options; "Mapping Pattern Navigation" for more efficient cleaning in less than half the time and "Free mode" for immediate cleaning without room registry**





LIDAR sensor + Camera sensor

**Obstacle detection with six ultrasonic sensors, one bumper sensor, and one LiDAR sensor (2D)**

- LiDAR sensor and front camera sensor help to map and save up to 5 rooms over 100,000sqft
- Automatic Homing Function enables the vacuum to return to its original cleaning position once cleaning is completed or the battery charge is low

**Excellent cleaning features useful in commercial applications**





**Dust box with 3L capacity**

Dual compartment structure - one for small debris, the other for large debris and Equipped with a highly efficient **filter Part no: 191P31-7**

**Cleaning prohibited areas with Magnet tape.** This tape laid on the floor prevents the cleaner from entering in cleaning prohibited areas

part # 191P18-9



**Sponge sheet for bumper** to protect the surrounding objects from damage part # 191X35-7



<b>Continuous Use (min.)</b>	w/ BL1860B x2: 240
<b>Max cleaning area</b>	w/ BL1860B x2: 600 m <sup>2</sup>
<b>Max registrable mapping area</b>	10,000 m <sup>2</sup>
<b>Rotation speed</b>	Main brush: 1,600 RPM / Side brush: 200 RPM
<b>Max running speed</b>	0.3 m/sec
<b>Dust box capacity</b>	3.0 L
<b>Dimensions (L x W x H)</b>	500 x 500 x 204 mm
<b>Net weight</b>	10.6 kg

**Standard Equipment:** Wireless remote controller (including two AAA alkaline batteries), Side brush, (Battery and charger sold separately)

**AVAILABLE VARIANTS**

**"Z" VARIANT**

**DRC300 Z**  
TOOL ONLY (DOES NOT INCLUDE BATTERY / CHARGER OR CARRY CASE)

DRC200
18V | LXT

**Cordless Robotic Cleaner**



### Large side brushes + Large power brush

Side brushes enable to clean alongside walls, around obstacles or tight corners in either of pattern/ random

Side Brush Part no: SH0000065

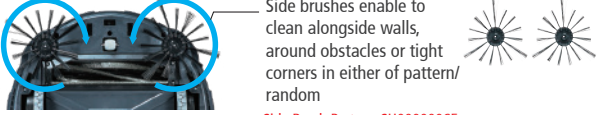

ø50mm x 260mm Large Power rotating brush

Power Brush Part no: SH0000063  
 Turn Brush Cover Part no: SH0000064



**Robotic cleaner for commercial/industrial use**

- Clean an area of 600m<sup>2</sup> per 240min, (coverage rate of 80%) (2 x BL1860B in parallel)
- Wireless remote controller

**Automatic cleaning (Pattern and Random mode)**

**Pattern cleaning mode**

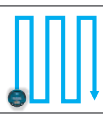

**Random cleaning mode**

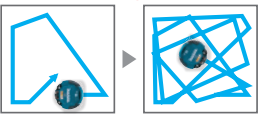

**Cleaning area setting function**

Area outside the defined cleaning area

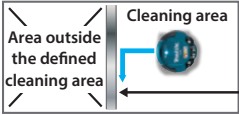



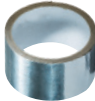

Cleaning area



Boundary line tape Part no: SH00000231

Enables user to define a cleaning area by putting boundary tape on the floor as boundary line that the cleaner cannot pass

**Excellent cleaning features useful in commercial applications**

**Dust box with 2.5L capacity**

Dual compartment structure - one for small debris, the other for large debris and Equipped with a highly efficient **filter Part no: SH00000213**



<b>Continuous use (minutes)</b>	w/ BL1850B x2: 200   w/ BL1830B x2: 120
<b>Max cleaning area</b>	w/ BL1850B x2: 500 m <sup>2</sup>   w/ BL1830B x2: 300 m <sup>2</sup>
<b>Max running speed</b>	0.3 m/sec
<b>Tank</b>	2.5 L
<b>Dimensions (L x W x H)</b>	460 x 460 x 180 mm
<b>Net weight</b>	7.8 kg

**Standard Equipment:** Wireless remote controller (including two AAA alkaline batteries), Side brush, (Battery and charger sold separately)

**AVAILABLE VARIANTS**

**"Z" VARIANT**

**DRC200 Z**  
TOOL ONLY (DOES NOT INCLUDE BATTERY / CHARGER OR CARRY CASE)

**DVC750L** 18V | **LXT**

**Cordless Vacuum Cleaner / Dust Extractor / Blower**



**Compact, portable and easy-to-use**  
**3 in ONE tools (Cleaning / Dust Extraction / Blowing)**  
 High power and long run time with Brushless Motor

**Nozzle can be stored**  
 Blower outlet Insert the hose to blower outlet and turn it clockwise until it clicks.



**2** **18V** **BL** **HEPA** **filter**

<b>Capacity</b>	Dust : 7.5 L / Water : 4.5L
<b>Continuous Use (min.)</b>	w/ BL1860B (High) : 35 / w/ BL1860B (Low) : 70
<b>Max Air Flow</b>	1.6 m³/min
<b>Max Sealed Suction</b>	6.7 kPa
<b>Suction Power</b>	High / Low : 50 / 25 W
<b>Dimensions (L x W x H)</b>	418x251x278 mm
<b>Net weight</b>	4.6 kg

**Standard Equipment:** Hose, Floor Nozzle, Sash Nozzle, Shoulder belt 199486-4 (optional)

**AVAILABLE VARIANTS**

**"Z" VARIANT**

**DVC750L ZX1**  
 TOOL ONLY  
 (DOES NOT INCLUDE BATTERY / CHARGER OR CARRY CASE)

**DCL184** 18V | **LXT**

**Cordless Car Cleaner / Blower**



**Compact cordless cleaner Powered by 18V Li-ion LXT battery**  
 • Ideal for in-car cleaning • Variable attachments suitable for in-car cleaning  
 • 2 functions in 1 machine convertible into a blower  
 • Battery capacity warning lamp starts blinking when the remaining battery capacity gets low

**3** **18V** **LITHIUM-ION**

<b>Capacity</b>	Cloth / Paper Dust Bag: 500 / 330 mL
<b>Continuous Use (min.)</b>	Max / High / Normal: 33 / 50 / 133
<b>Max Air Flow/</b>	Cleaning: 1.4 m³/mi / Blowing: 0.8 m³/min
<b>Max Air Velocity</b>	Blowing: 7.2 m/s
<b>Max Sealed Suction (water column)</b>	5.4 kPa
<b>Noise Level</b>	Max / High / Normal: 68 / 65 / 58 dB(A)
<b>Dimensions (L x W x H)</b>	365x138x202 mm
<b>Net weight</b>	2.2 kg

**Standard Equipment:** Seat vacuum nozzle, Mat nozzle, Rubber nozzle, Soft brush, Blower attachment, Dust Bag, Shoulder Belt

**AVAILABLE VARIANTS**

<b>3.0Ah</b>	<b>"Z" VARIANT</b>
<b>DCL184 RF</b> INCLUDES 1 BATTERY / 1 CHARGER AND TOOL BAG	<b>DCL184 Z</b> TOOL ONLY (DOES NOT INCLUDE BATTERY / CHARGER AND TOOL BAG)

**DVC350** 18V | **LXT**

**18V LXT - Lithium-ion Cordless Dust Extractor / Blower**



**Portable Dust extractor powered by 18V Li-ion battery.**  
**Convenient for use with Makita cordless tools**  
 • Variable switch provides High/Low air volume settings to suit your application.  
 • Shoulder belt can be easily slung over your shoulder for added mobility.

**2 functions in 1 machine**  
 Convertible into a blower by attaching nozzle assembly.



**2** **18V** **LITHIUM-ION**

<b>Max. peak air flow</b>	3.4m³ / min
<b>Max. sealed suction (water column)</b>	5.5kpa
<b>Recoverable capacity</b>	3.0L
<b>Dimensions (L x W x H)</b>	273 x 195 x 226mm
<b>Net weight</b>	2.2kg

**Standard Equipment:** Nozzle Assembly, Dust Bag Assembly, Hose Complete with front cuffs, Shoulder Belt

**AVAILABLE VARIANTS**

**"Z" VARIANT**

**DVC350 Z**  
 TOOL ONLY  
 (DOES NOT INCLUDE BATTERY / CHARGER OR CARRY CASE)

**CL121D** 12V MAX | **CXT**

**Cordless Car Cleaner / Blower**



**Compact cordless cleaner Powered by 12V Li-ion LXT battery**  
 • Ideal for in-car cleaning • Variable attachments suitable for in-car cleaning  
 • 2 functions in 1 machine convertible into a blower  
 • Battery capacity warning lamp starts blinking when the remaining battery capacity gets low

**3** **12V max** **LITHIUM-ION**

<b>Capacity</b>	Dust Bag : 500 mL / Paper Pack : 330 mL
<b>Continuous Use (min.)</b>	Max : 27 / High : 32 / Normal : 67
<b>Max Air Flow/</b>	1.3 m³/min
<b>Max Sealed Suction (water column)</b>	4.4 kPa (450 mmH <sub>2</sub> O)
<b>Noise Level</b>	Max : 30 W / High : 20 W / Normal : 5 W
<b>Dimensions (L x W x H)</b>	345x138x202 mm
<b>Net weight</b>	1.8 kg

**Standard Equipment:** Seat vacuum nozzle, Mat nozzle, Rubber nozzle, Soft brush, Blower attachment, Dust Bag, Shoulder Belt

**AVAILABLE VARIANTS**

<b>4.0Ah</b>	<b>"Z" VARIANT</b>
<b>CL121D SM</b> INCLUDES 1 BATTERY / 1 CHARGER AND TOOL BAG	<b>CL121D Z</b> TOOL ONLY (DOES NOT INCLUDE BATTERY / CHARGER AND TOOL BAG)

- DRILLING / FIXING
- CONCRETE DRILLING / DEMOLITION
- MIXING / STIRRING
- CUTTING (CONCRETE / METAL)
- GRINDING
- SANDING / POLISHING
- SAWING
- MULTI-TOOL
- ROUTERS / PLANERS
- NAILERS / STAPLERS
- HEAT GUN / LASER
- CLEANING
- OPE
- JOB SITE TOOLS
- SPECIALTY TOOLS
- HAND TOOLS / COMBINATION SET
- TOOL HOLDERS AND POUCHES / MAKPAC SYSTEM

# Cordless Stick Type Cleaners

DRILLING / FIXING

CONCRETE DRILLING / DEMOLITION

MIXING / STIRRING

CUTTING (CONCRETE / METAL)

GRINDING

SANDING / POLISHING

SAWING

MULTI-TOOL

ROUTERS / PLANERS

NAILERS / STAPLERS

HEAT GUN / LASER

CLEANING

OPE

JOBSITE TOOLS

SPECIALTY TOOLS

HAND TOOLS / COMBINATION SET

TOOL HOLDERS AND POUCHES / MAKAPAC SYSTEM



CL001G | CL002G | CL003G



DCL286F | DCL281 | DCL280 | DCL180



CL108FD | CL106FD



CL117FD



**High Power / Compact / Lightweight / Low noise**

Ideal for residential & commercial spaces like shops, offices, hospitals, schools, transport vehicles and home use.



## Brushless Motor

Provides High Power | High Performance | High Durability (for CL001G | CL002G | CL003G | DCL281, DCL280)

## HEPA Filter provides high filtration rate of 99.97%

(Standard with CL001G and DCL281, DCL280 optional for other stick cleaners)

## Push Button with speed selection and on/off function

with 3-speed power selection (for DCL281 | CL108FD)

with 4-speed power selection (for CL001G | CL002G | CL003G)

## LED joblight

With battery exhaust notification (Flashes when the battery capacity becomes low) (Except for DCL180 and CL183D)

## Pipe lock system

Pipe is fixed with the locking mechanism to prevent it from accidentally coming off (for DCL281 | DCL280 | CL001G | CL002G | CL003G)

## DUST COLLECTION

### Capsule type

Quick dust disposal, no need to use dust bag

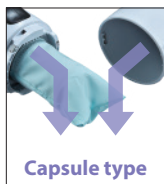

Capsule type

For models: CL001G, DCL281, DCL280, DCL180, CL108FD, CL106FD, CL183D

### Dust bag

Can be used with paper dust bag or cloth dust bag



Dust bag

For model: CL002G

### Cyclone type

Easy disposal of the fine dust



Cyclone unit

Maintain the high performance (suction power) even if the filter is clogged

For model: CL003G



# Attachments for Cleaners

COLOR CODE: IVORY SNOW-WHITE BLUE BLACK GREY

## Hoses



Type A  
Cuffs can be detachable



Type B  
fixed cuff



Type C  
with sleeve



● Standard ○ Suitable

PART #	DIA (mm)	CUFF TIP SIZE (mm)	LENGTH (m)	Type	VC3210L VC3211H VC007GL VC004GL	DVC157L DVC154L DVC864L	DVC150L DVC860L	VC003GL VC005GL	VC008G DVC261 DVC660	VC009G DVC265 DVC665	DVC750L	DVC350
143787-2	28mm	22, 24, 38	1.0m	A						○		
A-34235	28mm	22, 24, 38	1.5m	A	○	○	○	○		●		●
140G04-3	28mm	38	2.0m	B							●	
195437-5	28mm	22, 24, 38	2.5m	A	○	○	○	○		○		
195433-3	28mm	22, 24, 38	3.5m	A	●	●	○	○		○		
195436-7	28mm	22, 24, 38	5.0m	A	○	○	○	○		○		
199453-9	32mm	28	1.0m	C				○	●			
199493-7	32mm	28	1.7m	C				○	○			
199388-4	38mm	28	1.5m	C				○	○			
198757-6	38mm	38	1.5m	B	○	○	○	○		○		
195434-1	38mm	38	2.5m	B	●	○	●	○		○		
195435-9	38mm	38	5.0m	B	○	○	○	○		○		

PIPES PART #	CUFF TIP SIZE (mm)			VC3210L VC3211H VC007G VC004G	DVC157L DVC154L DVC864L	DVC150L DVC860L	VC003GL VC005GL	VC008G DVC261 DVC660	VC009G DVC265 DVC665	DVC750L	DVC350
192563-1	38mm	Straight Pipe	970mm	●	●	●				○	
192562-3		Bend Pipe		●	●	●				○	
1912G4-5	38mm	Telescopic Pipe	790 -	○	○	○					
1912G5-3		Bend Pipe	1140mm	○	○	○					
140G19-0	28mm	Telescopic Pipe	780 -				●	●	●		
140G26-3		Bend Pipe	1130mm				●	●	●		

Note:- Above pipes can fix with its respective hose with the same cuff tip size

⚡ Stopper for 1912G4-5 38mm straight pipe : 413R35-4 ■

## 38mm cuff tip attachments (For models: VC007GL, VC3210LX1, VC3211HX1, DVC150L, DVC860L, DVC750L)

(The below attachments can also be used with the cleaners VC004GL, DVC154L, DVC1547L DVC864L with the help of the cleaner attachment set 195439-1)

### ROUND BRUSH

● 191657-9



### LONG SASH NOZZLE

- 458919-1
- 410306-2
- 411891-8



### UPHOLSTERY NOZZLE

● 458891-7



### NOZZLE ASSEMBLY FLOORING & CARPET (DRY) WITH SWITCH

○ 198184-7



### FOR FLOOR (WET/DRY)

○ 195551-7



### COMPACT NOZZLE FOR FLOOR

● 195549-4 (DRY)



● 195550-9 (WET)



### WIDE NOZZLE FOR FLOOR (WET)

● A-47846



### NOZZLE FOR FLOOR (DRY)

● 199455-5



### HOSE STAND AND CLIP

Stand : 197323-6  
Clip : 195544-4

## Stick cleaner attachments

Stick Cleaners models: CL001G, CL002G, CL003G, DCL286F, DCL281, DCL280F, DCL180, CL108FD, CL106FD, CL183D, CL117FD

### STRAIGHT PIPE WITH LOCK

For models CL001G, CL002G, CL003G, DCL286F, DCL281, CL117FD, CL108FD,

- 459353-8
- 459356-2
- 458942-6
- 1910Y3-1 (Telescopic) ■



### STRAIGHT PIPE

For models DCL180, CL106FD

- 451424-7
- 451241-5
- 451244-9



### FLEXIBLE HOSE

- 191496-7
- 198867-9
- 198541-9
- 198543-5



### FLEXIBLE HOSE WITH LOCK

For models CL001G, CL002G, CL003G DCL281

● 191E30-3

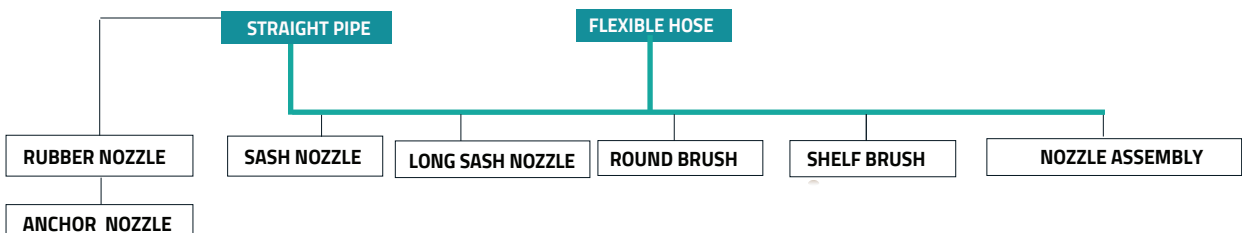

















COLOR CODE: IVORY SNOW-WHITE BLUE BLACK GREY

## 28mm cuff tip attachments and Stick Cleaners:

28mm cuff tip attachment models: VC003GL, VC005GL, VC008G, DVC660, DVC261  
 CL001G, CL002G, CL003G, DCL286F, DCL281, DCL280F, DCL180, CL108FD, CL106FD, CL183D, CL117FD  
 (The below attachments can also be used with the cleaner DVC750L with the help of the joint 418500-0)

 <p><b>SASH NOZZLE</b></p> <ul style="list-style-type: none"> <li>● 413769-1</li> <li>○ 413770-6</li> <li>● 451243-1 / 413859-0</li> <li>● 456586-6 / 413809-5</li> </ul>	 <p><b>SASH NOZZLE (LONG)</b></p> <ul style="list-style-type: none"> <li>○ 198919-6</li> <li>● 198990-0</li> <li>● 198992-6</li> <li>● 191D65-8</li> </ul>	 <p><b>ROUND BRUSH</b></p> <ul style="list-style-type: none"> <li>● 198548-5</li> <li>○ 198878-4</li> <li>● 198549-3</li> <li>● 198555-8</li> </ul>	 <p><b>SHELF BRUSH</b></p> <ul style="list-style-type: none"> <li>● 198537-0</li> <li>○ 198873-4</li> <li>● 198534-6</li> <li>● 198540-1</li> </ul>	 <p><b>RUBBER NOZZLE</b></p> <ul style="list-style-type: none"> <li>● 197901-2</li> </ul>	 <p><b>ANCHOR NOZZLE</b></p> <ul style="list-style-type: none"> <li>● 192236-6</li> </ul> <p>Rubber nozzle is additionally required</p>
--	---	--	--	--	--

**NOZZLE ASSEMBLY**

<p>For floor / carpet (swivel type)</p> <ul style="list-style-type: none"> <li>○ 127825-8</li> <li>● 127827-4</li> <li>● 127828-2</li> </ul> 	<p>For floor / carpet (with switch)</p> <ul style="list-style-type: none"> <li>○ 198183-9</li> <li>● 199431-9</li> </ul> 	<p>For floor / carpet (with switch &amp; swivel)</p> <ul style="list-style-type: none"> <li>○ 191G86-8</li> </ul> 	<p>For floor</p> <ul style="list-style-type: none"> <li>● 123485-4</li> <li>○ 123486-2</li> <li>● 123488-8</li> <li>● 123539-7</li> </ul> 	<p>For rug / carpet</p> <ul style="list-style-type: none"> <li>● 198150-4</li> <li>○ 198525-7</li> <li>● 198523-1</li> <li>● 198526-5</li> </ul> 	<p>Seat nozzle For automobile</p> <ul style="list-style-type: none"> <li>○ 199037-3</li> <li>● 199040-4</li> <li>● 199039-9</li> </ul> 	<p>Flat type</p> <ul style="list-style-type: none"> <li>● 199454-7</li> </ul> 	<p>Hard floor nozzle</p> <ul style="list-style-type: none"> <li>○ 191114-0</li> </ul> 	<p>Carpet nozzle</p> <ul style="list-style-type: none"> <li>○ 191116-6</li> </ul> 
--	--	---	---	--	---	---	---	---

Swivel joint with wheels provide increased maneuverability

- DRILLING / FIXING
- CONCRETE DRILLING / DEMOLITION
- MIXING / STIRRING
- CUTTING (CONCRETE / METAL)
- GRINDING
- SANDING / POLISHING
- SAWING
- MULTI-TOOL
- ROUTERS / PLANERS
- NAILERS / STAPLERS
- HEAT GUN / LASER
- CLEANING
- OPE
- JOB SITE TOOLS
- SPECIALTY TOOLS
- HAND TOOLS / COMBINATION SET
- TOOL HOLDERS AND POUCHES / MAKPAC SYSTEM

## Compact Cyclone Unit

(For stick cleaners)

Maintain the high performance (suction power) even if the filter is clogged



Easy disposal of the fine dust collected in dust case



- 1910D3-4
- 1910D4-2
- 1910D5-0

Compact cyclone unit comes as a standard with the cleaner CL003G, DCL286F  
 Cyclone unit also recommended to use with models: CL001G, DCL281F, DCL180

## Stand

(For stick cleaners)

- 1911L1-0



Base can hold LXT charger and small accessories

## Wall Bracket

(For stick cleaners)

- 199971-7

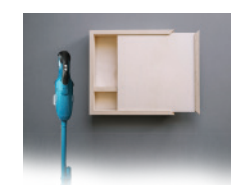

Accepts all 18V LXT / XGT Stick Cleaners

## Cyclone Unit

(For stick cleaners/ backpack Cleaners)

Cyclonic Vacuum Attachment is designed to expand the capacity to collect debris.

- Powerful cyclonic action captures up to 90% of dust particles before entering the main dust box
- Reduces the frequency of emptying the main dust box
- One-touch release for easy disposal of debris



Part # 191D71-3  
 With lock system (for stick type cleaners & Backpack cleaners with lock system)

Part # 199491-1  
 Without lock system (for stick type cleaners Backpack cleaners without lock system)



## Battery Adapter - BAP18C

Specially designed for use with 18V LXT cordless cleaners  
 Transfers the battery weight from the cleaner to user's waist to reduce the stress on hand

- 191M50-5

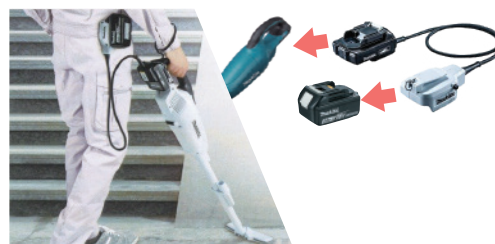

- TOOL HOLDERS AND POUCHES / MAKPAC SYSTEM

DRILLING /  
FIXING

## Attachments for Car Cleaners

For models: DCL184, CL121D

CONCRETE  
DRILLING /  
DEMOLITION

**FLEXIBLE HOSE**

● 140H92-6



**SOFT BRUSH**

● 140H94-2



**CORNER NOZZLE**

● 422437-5



**BLOWER NOZZLE**

● 140H94-2



**SEAT NOZZLE**

For automobile

○ 199037-3

● 199040-4

● 199039-9



**FLOOR & MATT  
NOZZLE**

● 459056-4



**UPHOLSTERY  
NOZZLE**

● 140H95-0



MIXING /  
STIRRING

CUTTING  
(CONCRETE /  
METAL)

## Attachments for Cyclone Cleaner

For model: DCL501

GRINDING

**HOSE**

● SH00000034



**STRAIGHT PIPE**

● SH00000060



**NOZZLE ASSEMBLY  
FLOOR & CARPET**

● SH00000058



**CREVICE NOZZLE**

● SH00000042



SANDING /  
POLISHING

SAWING

### For Model VC0002L

**STRAIGHT PIPE**

● P-72942



**NOZZLE ASSEMBLY  
FOR FLOOR AND MATT  
(WET / DRY)**

● W107402706



**FOR FLOOR  
(WET)**

● W000014295



**HOSE**

● P-81739  
32mm dia | 3.5m length

MULTI-TOOL

ROUTERS /  
PLANERS

## Cleaning set

195439-1

Straight pipe, Bend pipe, Nozzle assembly, Corner nozzle, 38mm Hose - 2.5m with cuff 38mm

For model VC007GL, VC004GL, VC005GL, VC003GL, DVC154L, DVC157L, DVC150L, DVC864L, DVC860L, VC3210LX1, VC3211HX1



NAILERS /  
STAPLERS

HEAT GUN /  
LASER

CLEANING

## BACKPACK HARNESS

Padded shoulder straps distribute weight evenly for improved comfort

Easily adjustable belt and straps for improved balance and control

Accessory holders on each side of the harness for added convenience

For Models: - VC008G & VC009G

**PART # : 191Y14-1** ■



OPE

JOBSITE  
TOOLS

SPECIALTY  
TOOLS

HAND TOOLS /  
COMBINATION SET

TOOL HOLDERS  
AND POUCHES /  
MAKPAC SYSTEM

## PROTECTION COVER

The padded protection cover is designed to protect backpack cleaners from knocks and bumps when vacuuming in tight spaces. Made from tear-resistant and water-repellent material. For Models: - DVC265, DVC261



**PART # : 191054-7** ■

### Filters and dust bags



	VC008G, VC009G	DVC660, DVC665	DVC261 DVC265
			
Main filter H set (HEPA Filter)	191Y27-2 	191D12-9 	123636-9 
Filter bag set (Paper dust bag)	197903-8 10PCS 	191C26-2 10PCS 	197782-4 10PCS 
Dust bag assembly (Cloth type)	197898-5 	191C30-1 	197898-5 



### Filters and dust bags



	DVC350 	DCL184 CL121D 
Dust bag	122918-6 	194566-1 5PCS 
Valve stay complete		143677-9 
Sponge sheet		422440-6 
 CL121D  Valve stay complete  Dust bag		







### Filters and dust bags

**Capsule Type Dust Box models: CL001G, DCL281, DCL180, CL108FD, CL106FD, CL183D**







Option 1 Stay with sponge  Option 1 HEPA Filter 

Pre-filter + filter  or Easy shake off Filter 



Easy shake off filter  or Pre-filter 

HEPA Filter 	199989-8
Pre-Filter 	451208-3 198750-0 (with package & country of origin)
Easy shake-off filter 	199966-0
Filter 	443060-3
Stay (Filter flame) 	458467-0
Sponge sheet 	422268-2 (not suitable for CL183D)

### Dust Bag type model: CL002G, DCL286F





















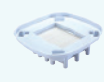



























Cloth dust bag 	198747-9
Paper dust bag 5pcs set 	194566-1
Easy shake off bag 	198748-7
High performance dust bag set 	1910M4-5
Valve stay complete 	143677-9
Guard 	413J77-0

### Cyclone unit type model: CL003G, DCL286F

Filter set <b>HEPA filter</b> 	1910C9-5
High performance filter set 	1910C7-9

- DRILLING / FIXING
- CONCRETE DRILLING / DEMOLITION
- MIXING / STIRRING
- CUTTING (CONCRETE / METAL)
- GRINDING
- SANDING / POLISHING
- SAWING
- MULTI-TOOL
- ROUTERS / PLANERS
- NAILERS / STAPLERS
- HEAT GUN / LASER
- CLEANING
- OPE
- JBSITE TOOLS
- SPECIALTY TOOLS
- HAND TOOLS / COMBINATION SET
- TOOL HOLDERS AND POUCHES / MAKPAC SYSTEM

Filters and dust bags

	DVC150L DVC860L	DVC154L DVC157L DVC864L	VC003GL VC004GL VC005GL	VC007GL	VC3211H	VC3210L	DVC750L	VC2000L	
									
Used as a set	Powder Filter Set (Dry use only) *HEPA filter	*197166-6 	*197166-6 	*191V70-3 	■ *1911B7-8 	196251-2 	195441-4 	*162518-0 	
	Pre-filter set	195553-3 	195553-3 	191V68-0 	■ 1911B5-2 	196253-8 	195612-3 	162635-6 	
	Damper set	195552-5 	195552-5 	191V69-8 	■ 1911B4-4 	196254-6 	195552-5 	422449-8 	
Cloth filter	140248-3 		144625-1  191V71-1 for VC005GL						
Water filter (Wet only)	195555-9 		191V67-2 	■ 1910N0-0 		195611-5 	191M39-3		
Filter bag set (For dry dust)	195557-5 15L / 5PCS (DVC150L) ■ 1912R3-4 10L / 5PCS (DVC860L)	195557-5 15L / 5PCS (DVC154L / 157L) ■ 1912R3-4 10L / 5PCS (DVC864L)	195557-5 15L / 5PCS (VC003GL, 4GL) ■ 1912R3-4 10L / 5PCS (VC005GL)	■ 1910Y4-9 35L / 5PCS 	195558-3 25L / 5PCS 	195558-3 25L / 5PCS 			
PAPER FILTER (For dry dust except powder)	A-48430 5PCS 	A-48430 5PCS 							
Poly bag set	195432-5 10PCS 	195432-5 10PCS 	195432-5 10PCS 	■ 1910R3-2 10PCS 	195440-6 10PCS 	195440-6 10PCS 			
Disposable bag								P-70297 5PCS 	
Filter bag								P-72899 5PCS 	

SHOULDER BAG DVC750L: 199486-4

### 406, 407, 440 - Vacuum Cleaner Hoses



■ Standard equipment

For Vacuum Model	Type	Vacuum Fitting		Attachment Fitting		Hose length	Part No.
		Inner dia (mm)	Outer dia (mm)	Inner dia (mm)	Outer dia (mm)		
406, 407	a	± 44	± 48	± 38	± 44	2.5 m	■ 193326-8
406, 407	a	± 44	± 48	± 38	± 44	5.0 m	193328-4
440	b	± 54	± 60	± 38	± 44	2.0 m	■ 01316B0N for vacuum attachment

Additional Hoses	Type	Tool Fitting		Hose to Hose Fitting		Hose length Meter	Part No.
		Inner dia (mm)	Outer dia (mm)	Inner dia (mm)	Outer dia (mm)		
Extremely flexible for connecting to small tools	d	± 19	± 25	± 32	± 38	2.5 m	192108-5

Attaches directly to 407/440 38mm standard equipment hoses

### 406, 407, 440 - Vacuum Cleaner Nozzles, Pipes and Filters

For Model	Type	Part No.
406, 407	Nozzle assembly	Standard Equipment
406, 407		Compact type (wet)
4072D		Floor Nozzle
440		Enables liftig of liquids (for carpets)
440	Pipe / Nozzle	Straight Pipe
440		Triangular Head Nozzle
440		Crevice Nozzle (size 45mm)
440		Multi Use brush (for Hard floors, concrete, tiles, carpets)
406, 407	Filter	Nylon Filter Set
440		Sponge Filter (for wet applications)
440		Powder Filter (Dry type)

### WUT02 - AWS Adapter for AC Cleaners

- Enables wireless On/Off communication of Makita AWS capable tools with AC Dust Extractors that include a tool-activated power outlet
- Allows communication between battery operated tools and extractor to eliminate cords, increase productivity, and reduce noise
- Includes an adaptable hanging hook and strap for easy attachment to multiple extractors



WUT02  
Part#: 199838-9



Channel setting button is used to test the successful pairing of the tool and extractor

Caution Lamp lights up red if adapter is overheating or other malfunction occurs



Wireless unit (Bluetooth chip)  
Part#: 198900-7 (optional)



**AWS**  
Auto-start wireless system enables the Dust Extractor runs automatically

DRILLING / FIXING

CONCRETE DRILLING / DEMOLITION

MIXING / STIRRING

CUTTING (CONCRETE / METAL)

GRINDING

SANDING / POLISHING

SAWING

MULTI-TOOL

ROUTERS / PLANERS

NAILERS / STAPLERS

HEAT GUN / LASER

CLEANING

OPE











JOBSITE TOOLS

SPECIALTY TOOLS



HAND TOOLS / COMBINATION SET

TOOL HOLDERS AND POUCHES / MAKPAC SYSTEM







## System Chart - Dust Collecting with Power Tools

<b>A</b>	<b>B</b>	<b>C</b>	<b>D</b>	<b>E</b>	<b>F</b>	<b>FRONT CUFFS</b>			<b>JOINT</b>
						<b>38</b> Dia 38mm	<b>22</b> Dia 22mm	<b>24</b> Dia 24mm	<b>22-38</b> Dia 22mm
<b>W/ Ø28mm Hose W/ Ø38mm Hose</b> VC3211H VC3210L VC004GL VC007GL (comes with Ø38mm Hose only)	<b>W/ Ø28mm Hose</b> DVC157L DVC154L DVC864L	<b>W/ Ø38mm Hose with fixed cuff 38</b> DVC150L DVC860L  <b>Use Optional Hose</b> VC003GL VC005GL	<b>W/ Ø28mm Hose</b> VC009G DVC665 DVC265	<b>W/ Ø28mm Hose</b> DVC350	<b>W/ Ø38mm Hose fixed cuff 38</b> DVC750L	 Thread type: Fit with 28mm Hose	 Thread type: Fit with 28mm Hose	 Rubber Type can fix with 38 & 22mm cuffs	 Fit with front cuff 38
						<b>Part No</b> 195545-2	<b>Part No</b> 195547-8	<b>Part No</b> 195546-0	<b>Part No</b> 195548-6









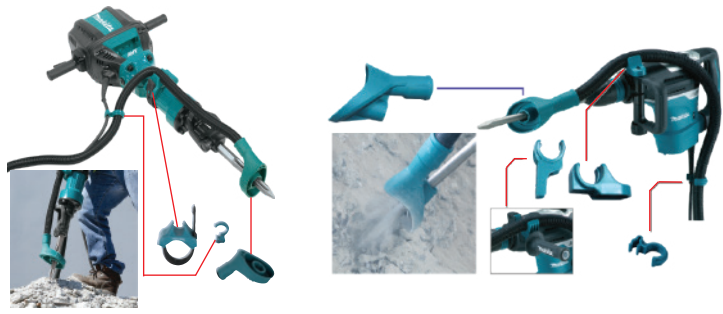









**Hose** Type a: Removable: front cuff can be removed and interchangeable with 22 and 38 front cuffs  
Type b: Front cuff is fixed with hose and cannot be removed



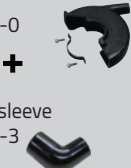































Type A Cuffs can be detachable  Type B fixed cuff 

PART #	DIA (mm)	CUFF TIP SIZE (mm)	LENGTH (m)	TYPE	VC3210L VC3211H VC007GL VC004GL	DVC157L DVC154L DVC864L	DVC150L DVC860L	VC003GL VC005GL	VC009G DVC265 DVC665	DVCL750L	DVC350
<b>143787-2</b>	28mm	22, 24, 38	1.0m	A					○		○
<b>A-34235</b>	28mm	22, 24, 38	1.5m	A	○	○	○	○	●		●
<b>140G04-3</b>	28mm	38	2.0m	B						●	
<b>195437-5</b>	28mm	22, 24, 38	2.5m	A	○	○	○	○	○		○
<b>195433-3</b>	28mm	22, 24, 38	3.5m	A	●	●	○	○	○		○
<b>195436-7</b>	28mm	22, 24, 38	5.0m	A	○	○	○	○	○		○
<b>198757-6</b>	38mm	38	1.5m	B	○	○	○	○	○		○
<b>195434-1</b>	38mm	38	2.5m	B	●	○	●	○	○		○
<b>195435-9</b>	38mm	38	5.0m	B	○	○	○	○	○		○





































	Model	Dust attachment	Part #	Cuffs size
<b>BREAKERS</b>	HM1511		191M21-2	Ø28mm hose can be directly connected to the suction device without front cuff
	HM1304, HM1306, HM1307C, HM1317C, HM1500, HM1801, HM1802, HM1810, HM1812		197168-2 197148-8	Ø28mm hose can be directly connected to the suction device without front cuff Cuff 24 or cuff 38
<b>DEMOLITION HAMMER</b>	HM001G, HM002G, HM0830, HM0870C, HM0871C, HM1101C, HM1111C, HM1201, HM1203C, HM1205C, HM1213C, HM1214C		199143-4	Ø28mm hose can be directly connected to the suction device without front cuff
	HM0870C/71C, HM1101C/11C, HM1203C/13C, HM1214C		196568-3	Ø28mm hose can be directly connected to the suction device without front cuff
<b>ROTARY HAMMER</b>	DHR400N, HR3540C/41FC, HR4030C, HR4001C/02/11C, HR4501C/11C		196568-3	Ø28mm hose can be directly connected to the suction device without front cuff
	DHR400N, HR005G HR4013C, HR4003C		197148-8	Cuff 24 or cuff 38
	HR5212C, HR5202C, HR4001C, HR4002, HR4010C, HR4501C, HR4510C, HR4511C, HR4041C, HR4030C, HR4013C, HR4003C, HR3541C, DHR400N, HR005G, HR006G		199144-2 199143-4	Cuff 24 or cuff 38 Ø28mm hose can be directly connected to the suction device without front cuff























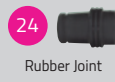







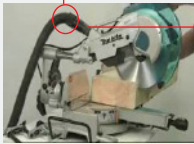



POWER TOOLS		SUCTION DEVICE		EXTRACTION UNITS WITH HOSE & CUFFS			
Rotary / Combi Hammer HR1841F, DHR182, DHR171, HR166D DHR202, DHR263 HR2800, HR2810 HR002G, DHR281, DHR283, HR2610T, HR2611FT, HR2630T, HR2631FT, HR3012FC HR003G, HR007G, DHR242, DHR280, HR2600, HR2630, HR2631F, HR2661, HR2663 HR008G, HR3011FC, HR3001C HR010G, DHR283		Grip base set + Dust cup set 194581-5 + 198362-9 194582-3 + 198362-9 - 198362-9 - 195179-1 - 195173-3 191L91-5 (spacer) - 1911P8-4		 <p>Dust cap set Hose with front cuff can be attached here</p> 		<p><b>A</b> VC3210LX1 / VC3211HX1 / VC004GL 28mm Standard Hose with 22mm front cuff</p>  <p>VC007GL 38mm Standard Hose with 22mm front cuff</p> 	
Rotary / Combi Hammer HR166D, DHR171, DHR182, DHR263, DHR264, HR2020, HR2460/F, HR2470/F/FT/T, HR26 & HR28 series		Dust Extractor 193472-7 		 <p>Dust Extractor Hose with front cuff</p>		<p><b>B</b> DVC157L / 154L, DVC864L 28mm Standard Hose with 22mm front cuff</p> 	
Rotary Hammer HR2010		Dust Extractor 192176-8		 <p>Hose with front cuff</p>		<p><b>C</b> DVC860L / 150L 38mm Standard Hose (to be used with joint 38-22)</p> 	
Rotary Hammer (Max. Bit Diameter 40mm) HR4011C, HR4001C HR4511C/01C, HR4002 HR5212C, HR5202C HR006G HR005G, DHR400N, HR4013C, HR4003C		Vacuum attachment 196074-8 		 <p>Hose with front cuff</p>		<p>VC003GL / VC005GL Use any Optional 28mm Hose with 22mm front cuff</p> 	
Angle Grinder N9500N, 9500NB 		Dust collecting wheel guard 192212-0 Rubber sleeve 192202-3 		 <p>Rubber sleeve Hose with front cuff Wheel guard</p>		<p><b>D</b> VC009G / DVC265 / DVC665 28mm Standard Hose with 22mm front cuff</p> 	
Angle Grinder For 115, 125mm For 100mm		Dust collecting wheel guard 192618-2 192475-8 				<p><b>E</b> DVC350 28mm Standard Hose with 22mm front cuff</p> 	
						<p><b>F</b> DVC750L 38mm Standard Hose (to be used with joint 38-22)</p> 	







POWER TOOLS	SUCTION DEVICE		EXTRACTION UNITS WITH HOSE & CUFFS
<p>Angle Grinder</p> <p>For 115, 125mm models for the grinder with 1 notch on bearing box</p> <p>For 115, 125mm XGT grinders</p> <p>For 180mm grinders</p>	<p>Dust collecting wheel guard - For cup type diamond wheel</p> <p>195237-3</p> <p>191F81-2</p> <p>191X44-6</p> 	 <p>Wheel guard</p> <p>Hose with front cuff</p>	<p><b>A</b> VC3210LX1 / VC3211HX1 / VC004GL 28mm Standard Hose with 38mm front cuff</p>  <p>VC007GL 38mm Standard Hose with 38mm front cuff</p>  <p><b>B</b> DVC157L / 154L, DVC864L 28mm Standard Hose with 38mm front cuff</p>  <p><b>C</b> DVC860L / 150L 38mm Standard Hose with 38mm front cuff</p>  <p>VC003GL / VC005GL Use any Optional 28mm Hose with 38mm front cuff</p>  <p><b>D</b> VC009G / DVC265 / DVC665 28mm Standard Hose with 38mm front cuff</p>  <p><b>E</b> DVC350 28mm Standard Hose with 38mm front cuff</p>  <p><b>F</b> DVC750L 38mm Standard Hose with 38mm front cuff</p> 
<p>For 115, 125mm models for the grinder with 1 notch on bearing box for the grinder with 3 notches on bearing box</p> <p>For 115, 125mm LXT X-LOCK grinders</p> <p>For 115, 125mm XGT grinders</p>	<p>Dust collecting wheel guard</p> <p>196846-1</p> <p>196845-3</p> <p>191G05-4</p> <p>191G06-2</p> 	 <p>Hose with front cuff</p> <p>Wheel guard</p>	
<p>For 115, 125mm</p> <p>For 180mm</p> <p>For 230mm</p>	<p>Dust collecting wheel guard</p> <p>193794-5</p> <p>194303-3</p> <p>194044-1</p> 	 <p>Hose with front cuff</p> <p>Wheel guard</p>	
<p>For 230mm models for XGT 180mm model for XGT 230mm model</p>	<p>Dust collecting wheel guard</p> <p>198380-7</p> <p>198514-2</p> <p>198440-5</p> 		
<p>Power Cutter CE002G</p> 	<p>Directly connected</p>		
<p>Angle Cutter 4112HS</p> 	<p>Elbow joint 32 192613-2</p> 	 <p>Hose with front cuff</p> <p>Elbow joint</p>	
<p>Dustless Cutter 4105KB</p> 			
<p>DCC501</p>	<p>Directly connected</p>		
<p>Wall Chaser SG1251, SG1250</p> 	<p>Directly connected</p>	 <p>Extraction point (comes along with the machine)</p> <p>Hose with front cuff</p>	
<p>Concrete Planer PC5000C, PC5001C</p> 	<p>Directly connected</p>	 <p>Hose with front cuff</p>	
<p>Belt Sander 9924DB</p> 	<p>Joint 192518-6</p> 		
<p>9403, 9404, 9910, 9920, 9921</p> 	<p>Directly connected</p>	 <p>Hose with front cuff</p> <p>Extraction point (comes along with the machine)</p>	
<p>Wheel Sander 9741</p> 	<p>Joint 410899-9</p> 		



POWER TOOLS	SUCTION DEVICE		EXTRACTION UNITS WITH HOSE & CUFFS
<p>Compact Cutter DMC300</p> 	<p>Dust collecting wheel guard 122C54-6</p> 		
<p>Circular Saw DSS610 HS301D</p> 	<p>Joint 419283-5 452237-9</p> 	 <p>Hose with front cuff</p> <p>Joint</p>	<p><b>A</b> VC3210LX1 / VC3211HX1 / VC004GL 28mm Standard Hose with 22mm front cuff</p> 
<p>Plate Joiner PJ7000, 3901 DPJ180</p> 	<p>Directly connected</p>	 <p>Extraction point (comes along with the machine)</p> <p>Hose with front cuff</p>	<p>VC007GL 38mm Standard Hose with 22mm front cuff</p> 
<p>Jig Saw JV100D, JV101D, JV183D, 4326, 4327, 4328, 4329</p> 	<p>Directly connected</p>	 <p>Hose with front cuff</p>	<p><b>B</b> DVC157L / 154L, DVC864L 28mm Standard Hose with 22mm front cuff</p> 
<p>Jig Saw DJV180, 4350CT/FCT, 4351FCT</p> 	<p>Dust nozzle 417853-4</p> 	 <p>Dust nozzle</p> <p>Hose with front cuff</p>	<p><b>C</b> DVC860L / 150L 38mm Standard Hose (to be used with joint 38-22)</p> 
<p>Drywall Cutter DSD180 SD100D</p> 	<p>Directly connected</p>	 <p>Extraction point (comes along with the machine)</p> <p>Hose with front cuff</p>	<p>VC003GL / VC005GL Use any optional 28mm Hose with 22mm front cuff</p> 
<p>Cut-out-Tool 3706 DCO181</p> 	<p>Dust collecting cover 193449-2</p> 	 <p>Dust collecting cover</p> <p>Hose with front cuff</p>	<p><b>D</b> VC009G / DVC265 / DVC665 28mm Standard Hose with 22mm front cuff</p> 
<p>Multi Tool TM3000C TM3010CK DTM51 DTM52</p> 	<p>Dust attachment 196022-7 196550-2 196765-1 191R02-6</p> 	 <p>Dust attachment</p> <p>Hose with front cuff</p>	<p><b>E</b> DVC350 28mm Standard Hose with 22mm front cuff</p> 
<p>Belt Sander DBS180, 9032</p> 	<p>Dust nozzle 122652-8</p> 	 <p>Dust nozzle</p> <p>Hose with front cuff</p>	<p><b>F</b> DVC750L 38mm Standard Hose (to be used with joint 38-22)</p> 
<p>Belt Sander 9031</p> 	<p>Directly connected</p>		
<p>Finishing Sander 9046, B03700, B03710 B04900, B04901, B04555 B04556, B04565, B04566, DB0482, DB0380, DB0381</p> 	<p>Directly connected</p>	 <p>Extraction point (comes along with the machine)</p> <p>Hose with front cuff</p>	
<p>Random Orbit Sander B05030, B05041 B06030 B06040, DB0180</p> 	<p>Directly connected</p>		

POWER TOOLS	SUCTION DEVICE	EXTRACTION UNITS WITH HOSE & CUFFS
Random Orbit Sander B06050 	 <p>24 Rubber Joint</p>	
Drywall Sander DSL800, DSL801	 <p>24 Rubber Joint</p>	<p><b>A</b> VC3210LX1 / VC3211HX1 / VC004GL 28mm Standard Hose with 38mm front cuff</p>  <p>VC007GL 38mm Standard Hose with 38mm front cuff</p> 
Aluminum Groove Cutter CA5000XJ 	 <p>24 Rubber Joint</p>	<p><b>B</b> DVC157L / 154L, DVC864L 28mm Standard Hose with 22mm or 38mm front cuff</p> 
Plunge cut circular saw SP001G, SP6000 DSP600, DSP601 Circular Saw HS004G, HS009G, HS011G, DHS900 Rear handle saw RS001G, DRS780 RS002G	 <p>24 Rubber Joint</p>	<p><b>C</b> DVC860L / 150L 38mm Standard Hose with 38mm front cuff</p> 
Circular Saw DHS660, DHS661 HS012G, DHS680 DHS783, HS7010 HS0600	Joint (Dust nozzle) 199230-9 196952-2 196520-1 198263-1  <p>24 Rubber Joint</p>	<p><b>D</b> DVC009G / DVC265 / DVC665 28mm Standard Hose with 22mm or 38mm front cuff</p> 
Jig Saw JV103D, JV102D DJV184 JV001G	Joint (Dust nozzle) 457801-1 413F05-1 122C71-6  <p>24 Rubber Joint</p>	<p><b>E</b> DVC350 28mm Standard Hose with 22mm front cuff</p> 
Circular Saw 5143R 5704R N9500N	Joint (Nozzle) 192490-2 192420-3 193068-4  <p>(Note: 5143R, 5704R &amp; N9500N fits only to the front cuff 38)</p>	<p><b>F</b> DVC750L 38mm Standard Hose with 38mm front cuff</p> 
Slide Compound Miter Saw LS1219L, LS1019L, DLS211, DLS111 LS002G, LS003G, LS004G	 <p>24 Rubber Joint</p>	

POWER TOOLS	SUCTION DEVICE		EXTRACTION UNITS WITH HOSE & CUFFS								
<p>Slide Compound Saw / Miter Saw / Compound Saw LS0714, LS1016, LS1216, DLS714, DLS713 LS1018L, LS0815FL / LS1440, LS1040 / DLS600</p>  <p>Table Top Miter Saw LH1201FL, LH1040</p> 	<p>Directly connected</p>	<p>Hose with front cuff</p>  <p>Extraction point (comes along with the machine)</p>	<p><b>A</b> VC3210LX1 / VC3211HX1 / VC004GL 28mm Standard Hose with 38mm front cuff</p>  <p>VC007GL 38mm Standard Hose with 38mm front cuff</p> 								
<p>Flip Over Saw LF1000</p>  <p>Table Saw</p> 	<p>Directly connected</p> <p>Joint</p> <table border="1" data-bbox="386 948 670 1097"> <tr> <td>MLT100</td> <td>JM27000090</td> </tr> <tr> <td>2703</td> <td>192799-2</td> </tr> <tr> <td>2704</td> <td>419093-0</td> </tr> <tr> <td>2712</td> <td>Directly connected</td> </tr> </table> 	MLT100	JM27000090	2703	192799-2	2704	419093-0	2712	Directly connected	<p>Hose with front cuff</p>  <p>Extraction point (comes along with the machine)</p>	<p><b>B</b> DVC157L / 154L, DVC864L 28mm Standard Hose with 38mm front cuff</p>  <p><b>C</b> DVC860L / 150L 38mm Standard Hose with 38mm front cuff</p>  <p>VC003GL / VC005GL Use any optional 28mm Hose with 38mm front cuff</p> 
MLT100	JM27000090										
2703	192799-2										
2704	419093-0										
2712	Directly connected										
<p>Band Saw LB1200F</p> 	<p>Dust point 419093-0</p>		<p><b>D</b> VC009G / DVC265 / DVC665 <i>(not recommended to use with these cleaners)</i></p> 								
<p>Scroll saw SJ401</p>	<p>Rubber sleeve 36-38 A-30617</p>		<p><b>E</b> DVC350 <i>(not recommended to use with these cleaners)</i></p>  <p><b>F</b> DVC750L 38mm Standard Hose with 38mm front cuff</p> 								

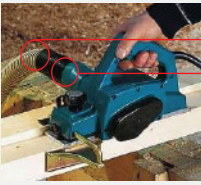
POWER TOOLS	SUCTION DEVICE		EXTRACTION UNITS WITH HOSE & CUFFS
<b>Router</b> RP1800/F, RP2300FC RP0900, RT001G, DRT50, RT0700C, RT0702C, For model RT001G, DRT50, RT0700C, RT0702C, Use with plunge base assembly	Nozzle 194934-8 194733-8	 <p>Hose with front cuff</p> <p>Nozzle</p>	<p>Recommended to use 38mm dia hose when using router, trimmer and planer</p> <p><b>A</b> VC3210LX1 / VC3211HX1 / VC004GL                      38mm Standard Hose with 38mm front cuff</p>  <p>VC007GL                      38mm Standard Hose with 38mm front cuff</p>  <p><b>B</b> DVC157L / 154L, DVC864L                      Use any 38mm Optional Hose with 38mm front cuff</p>  <p><b>C</b> DVC860L / 150L                      38mm Standard Hose with 38mm front cuff</p>  <p>VC003GL / VC005GL                      Use any 38mm Optional Hose with 38mm front cuff</p> <p><b>D</b> VC009G / DVC265 / DVC665                      Use any 38mm Optional Hose with 38mm front cuff</p>  <p><b>E</b> DVC350                      Use any 38mm Optional Hose with 38mm front cuff</p> <p>DVC350 cannot be used with Power Planer models</p>
<b>Trimmer</b> RT001G, DRT50, RT0700C	Nozzle 195559-1		
<b>Power Planer</b> DKP180	Nozzle 451329-1	 <p>Hose with front cuff</p> <p>Nozzle</p>	
<b>Power Planer</b> 1911B	Nozzle 192082-7	 <p>Hose with front cuff</p> <p>Nozzle</p>	
<b>Power Planer</b> 1805N N1900B, N1923B KP0800XK	Nozzle + Joint JPA122277 (nozzle)+ 181575-9 (joint) 181572-5 (nozzle)+ JPA122275 (joint) 451329-1(nozzle) + 416368-8 (elbow)		
<b>Power Planer</b> KP001G, DKP181, KP0810	Directly connected		

POWER TOOLS	SUCTION DEVICE	EXTRACTION UNITS WITH HOSE & CUFFS
Planer / Thicknesser 2012NB	Hood set 193036-7 (Outer dia. 76 mm)	Connects with inner dia. 76 mm Hose

# High Pressure Washer



DHW080

18V+18V | LXT

Cordless Pressure Washer

**50L**

Water tank capacity



Featuring transportability and high washing performance enough to clean cars or agricultural machinery

Supplying water from a tank / reservoir



- Water can be supplied not only from a faucet but also from a tank or bucket using self-suction hose set.
- 50L Tank with Functional storage box

- Adjustable pressure function with two pressure modes for various applications



<b>Max Feed Volume</b>	6.3 L/min
<b>Water Flow Rate</b>	High / Low: 5.5 / 4.0 L/min
<b>Max Permissible Pressure</b>	8.0 MPa
<b>Working Pressure</b>	High / Low: 5.5 / 3.0 MPa
<b>Max Feed Temperature</b>	40 °C
<b>Max Suction Height</b>	1 m
<b>Max Run Time (min)</b>	w/ BL1850B x2: High / Low : 12.5 / 28
<b>Hose Length</b>	5 m
<b>Tank capacity</b>	50 L
<b>Dimensions (L x W x H)</b>	438x218x269 mm
<b>Net weight</b>	7.7 kg

**Standard Equipment:** Trigger Gun, High Pressure Hose 5m, Suction Hose, Storage Box, Variospray Lance, Variable Nozzle, Absorption Connector, One Touch Joint.

5.0Ah	3.0Ah	"Z" VARIANT
<b>DHW080 PT2</b> INCLUDES 2 BATTERIES / 1 TWO PORT CHARGER (WITH WATER TANK)	-	<b>DHW080 ZK</b> TOOL ONLY (WITH WATER TANK) (DOES NOT INCLUDE BATTERY / CHARGER)

- DRILLING / FIXING
- CONCRETE DRILLING / DEMOLITION
- MIXING / STIRRING
- CUTTING (CONCRETE / METAL)
- GRINDING
- SANDING / POLISHING
- SAWING
- MULTI-TOOL
- ROUTERS / PLANERS
- NAILERS / STAPLERS
- HEAT GUN / LASER
- CLEANING
- OPE
- JOBSITE TOOLS
- SPECIALTY TOOLS
- CARRY CASE / TOOL HOLDERS / POUCHES

## HW1200

### High Pressure Washer

**Makita-built powerful 1,800 W series motor provides up to 12 MPa for maximum cleaning power (Self-Priming Function)**

- Pressure adjustable function for easy and quick control by turning the handle
- 420 L/hr max flow rate
- Powerful washing 10 MPa (100 bar) of working pressure (up to 50X as tap water)
- Lightweight and compact, middle class power washer

Continuous rating input	1,800W
Max Pressure	12 MPa (120 bar, 1,740 PSI)
Max Flow Rate	420 L/h
Max Feed Temperature	40 °C (104 °F)
High Pressure Hose Length	10 m (33 ft.)
Sound Pressure Level	72 dB(A)
Vibration Level	4.11 m/s <sup>2</sup>
Dimensions (L x W x H)	292x358x830 mm
Net weight	11.0 kg
Power supply cord	5.0 m

**Standard Equipment:** Trigger Gun, Vario-Power Spray Lance, Cyclone jet nozzle, Detergent Bottle, Cleaner Pin, Coupling Sleeve, High Pressure Hose 10 m, Water Hose Connector, Foam Nozzle, Connector

## HW1300

### High Pressure Washer

**Makita-built powerful 1,800 W series motor provides up to 13 MPa for maximum cleaning power (Self-Priming Function)**

- Pressure adjustable function and low noise mode
- Pressure adjustable function for easy and quick control by turning the handle
- Low noise mode enables soft washing of screen door, air conditioner outdoor unit, car, etc.
- 450 L/hr max flow rate

Continuous rating input	1,800W
Max Pressure	13 MPa (130 bar, 1,885 PSI)
Max Flow Rate	420 L/h
Max Feed Temperature	40 °C (104 °F)
High Pressure Hose Length	10 m (33 ft.)
Sound Pressure Level	76 dB(A)
Vibration Level	4.86 m/s <sup>2</sup>
Dimensions (L x W x H)	292x358x830 mm
Net weight	12.7 kg
Power supply cord	5.0 m

**Standard Equipment:** Trigger Gun, Vario-Power Spray Lance, Cyclone jet nozzle, Detergent Bottle, Cleaner Pin, Coupling Sleeve, High Pressure Hose 10 m, Water Hose Connector, Foam Nozzle, Connector

## HW131

### High Pressure Washer

**Must be used lying down**

**Ideal for industrial users.**

- Is fitted with a Triplex pump with ceramic coated pistons controlled by connecting a rod system for heavy duty tasks and prolonged use.
- It is equipped with a wheeled trolley for easy moving and an integrated accessory holder for easy storage.
- It also has a water filter, an induction electric motor as well as an adjustable spray head with high/low pressure with pencil/fan jet settings.

Maximum Pressure	Max 130 bar
Maximum Flow	500 L/hr
Induction Motor	2,3 kW 230V 50Hz
Hose Length	15m
Net Weight	33kg

**Standard Equipment:** Gun and Lance with Hi/Low and Pencil/fan Adjustable Nozzle, Rotopower Turbo Lance, On Board Detergent Tank, Pressure Gauge, Triplex Plunger Pump with Connecting Rod System.

## HW151

### High Pressure Washer

**Ideal for industrial users.**

- Built-in accessories holder.
- Rubber tread wheels.
- Built-in hose reel.
- Swivel connection accessories, Steel armed hose.
- Brass head / Steel frame.

Maximum Pressure	Max 150 bar
Maximum Flow	500 L/hr
Induction Motor	2,5 kW
Hose Length	10m
Net Weight	26.9 kg

**Standard Equipment:** Gun (metal type), Adjustable Spray Lance and Detergent head.

# High Pressure Washer accessories for DHW080, HW1200, HW1300



**Cyclone jet nozzle set**  
Part No. 197824-4



**Cyclone guard set**  
Part No. 197864-2



**Variospray lance set**  
Part No. 197876-5



**Foam nozzle set**  
Part No. 197886-2



**Wash brush set**  
Part No. 197828-6



**Variable nozzle set**  
Part No. 197822-8



**Rotating brush set**  
Part No. 197831-7



**Pipe cleaning hose**  
Part No. 197837-5 (10m)  
197840-6 (15m)

**Under body spray lance set**  
DHW080  
HW1200, HW1300  
for 110-127V)  
197859-5  
HW1200, HW1300  
for 220V-240V)  
198909-9

**Vario spray lance set**  
191U88-8  
**Vario spray nozzle set**  
191U86-2

**Accessory joint set**  
Part No. 197853-7

**Trigger gun set**  
Part No. 197842-2

**Extension pipe set**  
Part No. 197870-7

**Twist prevention joint set**  
Part No. 197867-6

**High pressure extension hose**  
Part No. 197845-6 (5m)  
197847-2 (8m)  
197850-3 (10m)

**High pressure hose**  
Part No. 126766-5 (PVC) (5m)



**Water Reservoir Set 1**  
1978 81-2 Connector + 197873-1 Self suction hose with strainer 1

**Water Reservoir Set 2**  
1910R1-6 Water hose with connector and one touch joint + 1910R2-4 Self suction hose with strainer 2

**For connecting with water tap**  
1910R1-6 Water hose with one touch joint + connector

One touch joint 197883-8 (for water hose to tap water)

**Trolley - able to stack on for easy loading**  
Part No. TR0000002

**Cleaner pin set**  
Part No.: 197879-9  
**Shoulder Belt**  
199486-4

# Garden Tools

Muti Function Power Head, Chain Saw, Hedge Trimmer, Brush Cutter, Edger, Grass Trimmer, Grass Shear, Lawn Mower, Blower. Sprayer. Earth Auger





# Makita Lithium-ion Cordless Garden Tools

Best choices for resorts, hotels, public places and among residential areas due to

**ZERO** EMISSION + **ZERO** POLLUTION + **LOW** NOISE + **LOW** VIBRATION + **EASY** MAINTENANCE

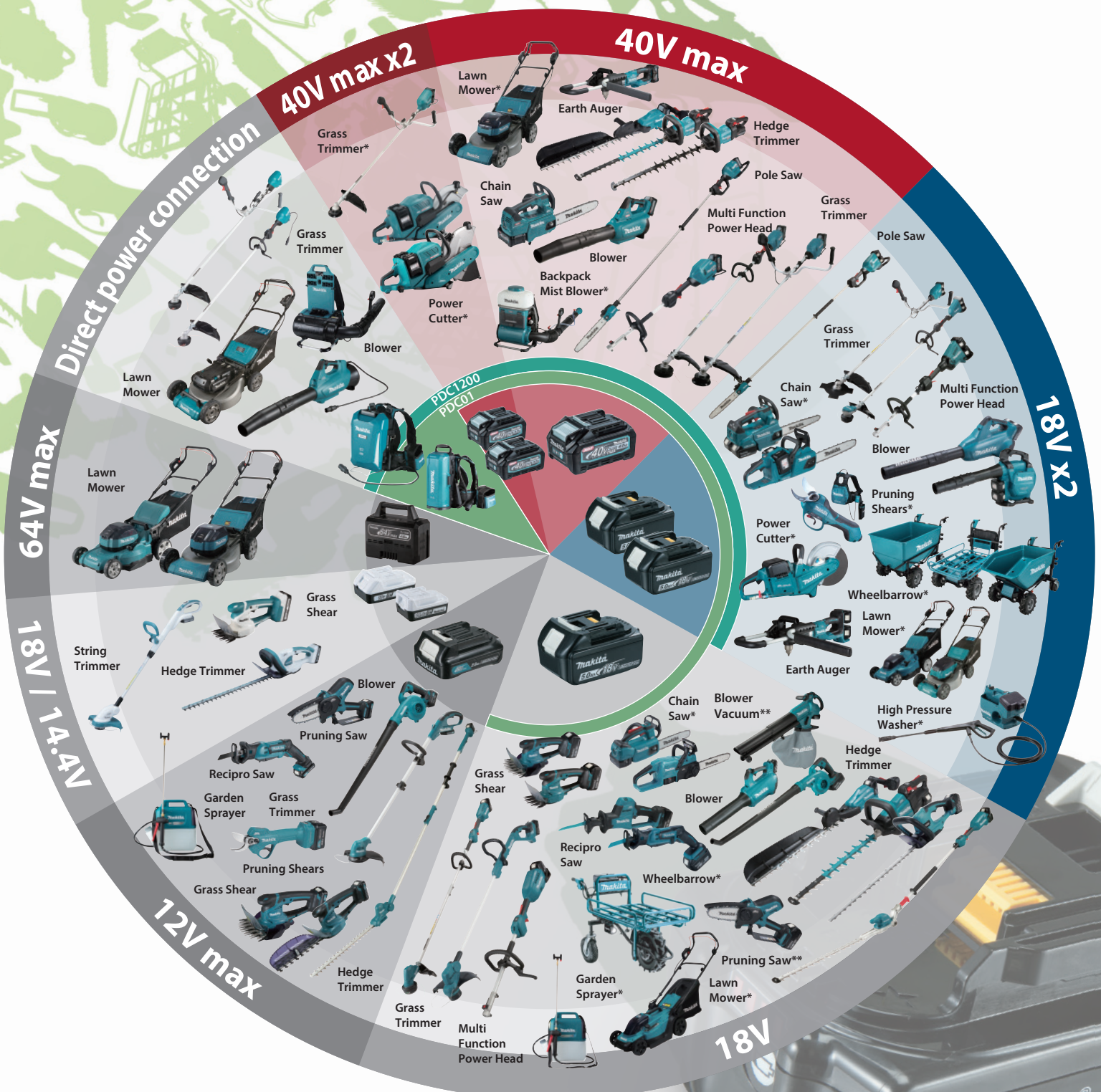

\* These models are not compatible with Portable Power Pack (PDC1200, PDC01)

Only rear handle type chainsaws are compatible

\*\* These models are not compatible with Portable Power Pack (PDC1200)



# Cordless advantage

ZERO Emission



Low noise



## Easy to Use



### Start-up

Engine tools



Engine tools need time and tips to start-up.

### Constant speed control

Engine tools

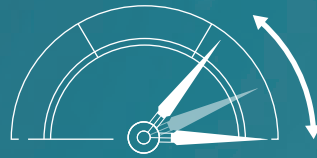

Engine tools are hard to keep the constant rotation speed under load

Cordless tools



Cordless tools start just after inserting battery and switching on

Cordless tools

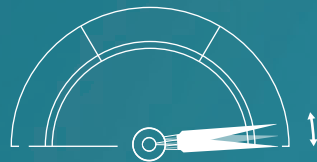

Cordless tools keep rotation speed under load with "Constant speed control" function

## Clean & Easy Maintenance



### Zero emission

Engine tools



Cordless tools



Cordless tools don't generate any exhaust gas

### Cost and time reduction

Engine tools



It takes time to prepare mixed fuel for Engine

Cordless tools



Just insert battery and ready to use

### Easy maintenance

Engine tools

Engine tools take time for maintenance



Cordless tools

Cordless tools are maintenance-free unlike Engine tools



### Long term storage

Engine tools

If you store the tool for a long period, when the fuel remained in the tank

It may be a cause of trouble or defect

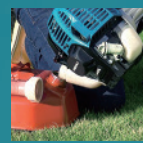

Remaining fuel must be extracted completely before storage

Cordless tools

Even if you store the tools for a long period,

Just insert battery and ready to use



# Multi Function Power Head

**Multi Function Power Head** designed for wide range of garden and agricultural applications. Multi Function Power Head is for users with multiple garden applications with different attachments. This reduces the need for purchasing multiple tools for different applications thereby saving cost and space.



## VARIOUS OPTIONAL ATTACHMENTS FOR ALL YOUR GARDEN NEEDS

<b>Brushcutter</b> EM400MP 195654-7	<b>Rotary Scissors</b> EM407MP 191M60-2	<b>Edger</b> EE400MP 196752-0	<b>Pole saw</b> EY401MP 196104-5	<b>Hedge trimmer</b> EN410MP 197740-0	<b>Ground trimmer</b> EN420MP 198060-5	<b>Cultivator</b> KR400MP 195713-7	<b>Power brush</b> BR400MP 199326-6	<b>Power sweep</b> SW400MP 199347-8	<b>Blower</b> UB400MP 191F72-3	<b>Water Pump</b> PF400MP BRAPF400MP
<b>Grass trimmer</b> EM408MP 191N35-7 ER400MP 195528-2	<b>Pole hedge trimmer</b> EN401MP 196342-9	<b>Pole saw</b> EY403MP 191T39-5	<b>Ground trimmer</b> EN424MP 1913D3-2	<b>Cultivator</b> KR401MP 199188-2	<b>Power brush</b> BR400MP 199326-6	<b>Power sweep</b> SW400MP 199347-8	<b>Blower</b> UB401MP 191P78-1 UB402MP 1912S0-7	<b>Water Pump</b> PF400MP BRAPF400MP		

**Shaft extension LE400MP - 196032-4**  
For Pole saw, Pole hedge trimmer

**Easy change**  
Lever style lock system allows for quick toolless installation and replacement of the attachments.

**Active Feedback sensing Technology**

- If kickback occurs while using below attachment, brake works automatically:
  - Brushcutter attachment with metal blade
  - Pole saw attachment
- If the sensor detects drastically decrease of rotation, the motor stops immediately

**AFT**

Reverse button for easy removal of grass clippings from t/he cutting tool only for UX01G and DUX60

**Extreme Protection Technology (XPT)**  
Enhanced Dust and Drip-proof performance ensure reliable operation even under bad weather

**Wet Guard / IPX4**  
High water-resistance allows to operate the machine even if it is wet with water

	<b>UX01G</b> 40V MAX   <b>XGT</b>	<b>DUX60</b> 18Vx2   <b>LXT</b>	<b>DUX18</b> 18V   <b>LXT</b>
	<b>40V MAX XGT</b>	<b>18V + 18V LXT</b>	<b>18V LXT</b>
<b>Max Output</b>	1.0 kW	0.6kW	0.47 kW
<b>No Load Speed (RPM)</b>	High: 0 - 9,700 Medium: 0 - 8,200 Low: 0 - 5,700	High: 0 - 9,700 Medium: 0 - 8,200 Low: 0 - 5,700	High: 0 - 9,700 Low: 0 - 6,800 -
<b>Dimensions (L x W x H)</b>	1,027 x 320 x 209 mm	1,011x320x216 mm	983 x 318 x 175 mm
<b>Net weight (without battery)</b>	3.5kg	3.3kg	2.5 kg
<b>Motor</b>	Brushless Motor	Brushless Motor	Brushless Motor
<b>Variable speed control</b>	3-speed selection	3-speed selection	2-speed selection
<b>Active Feedback Sensing Technology</b>	✓	✓	✓
<b>Grass clipping removal function</b>	✓	✓	-
<b>Protection against Dust and Water</b>	Wet Guard	XPT	XPT
<b>Constant speed control</b>	✓	✓	✓
<b>Brake</b>	✓	✓	✓
<b>Soft Start</b>	✓	✓	✓
	<b>"Z" VARIANT</b>	<b>"Z" VARIANT</b>	<b>"Z" VARIANT</b>
	<b>UX01G Z</b> TOOL ONLY	<b>DUX60 Z</b> TOOL ONLY	<b>DUX18 Z</b> TOOL ONLY

- DRILLING / FIXING
- CONCRETE DRILLING / DEMOLITION
- MIXING / STIRRING
- CUTTING (CONCRETE / METAL)
- GRINDING
- SANDING / POLISHING
- SAWING
- MULTI-TOOL
- ROUTERS / PLANERS
- NAILERS / STAPLERS
- HEAT GUN / LASER
- CLEANING
- OPE
- JOB SITE TOOLS
- SPECIALTY TOOLS
- HAND TOOLS / COMBINATION SET
- TOOL HOLDERS AND POUCHES / MAKPAC SYSTEM

# Chain Saw



DRILLING /  
FIXING

CONCRETE  
DRILLING /  
DEMOLITION

MIXING /  
STIRRING

CUTTING  
(CONCRETE /  
METAL)

GRINDING

SANDING /  
POLISHING

SAWING

MULTI-TOOL

ROUTERS /  
PLANERS

NAILERS /  
STAPLERS

HEAT GUN /  
LASER

CLEANING

OPE

JOBSITE  
TOOLS

SPECIALTY  
TOOLS

HAND TOOLS /  
COMBINATION SET

TOOL HOLDERS  
AND POUCHES /  
MAKPAC SYSTEM

## Cordless Chain Saw

MODEL NO	VOLTAGE	GUIDE BAR	CHAIN SPEED	NET WEIGHT	BL MOTOR	BRAKE	CONSTANT SPEED
UC012G	40V MAX XGT	400mm (16")	0-25.5 m/s	4.5kg	YES	YES	-
UC002G	40V MAX XGT	250mm (10")	0-24.8 m/s	2.6kg	YES	YES	-
DUC405	18V+18V LXT	400mm (16")	0 - 20 m/s	4.4kg	YES	YES	YES
DUC252	18V+18V LXT	250mm (10")	8.3 m/s	3.4kg	-	YES	YES
DUC307	18V LXT	300mm (10")	7.7 m/s	3.7kg	YES	YES	-
DUC254	18V LXT	250mm (10")	0 - 24 m/s	2.0kg	YES	YES	-

## Petrol Chain Saw

MODEL NO	GUIDE BAR	DISPLACEMENT	POWER RATING	FUEL TANK	CHAIN OIL TANK	WEIGHT
EA3502S40B	400mm (16")	35 mL	1.7KW / 2.4PS	0.4L	0.29L	4.4kg
EA6100P	500mm (20")	60.7 mL	3.4KW/ 4.6PS	0.8L	0.48L	6.0kg

## Electric Chain Saw

MODEL NO	GUIDE BAR	POWER	CHAIN SPEED	NET WEIGHT	BRAKE	SOFT START
UC4041A	400mm (16")	1,800W	870m/min	4.7kg	YES	-
UC4551A	450mm (18")	2,000W	870m/min	5.7kg	YES	YES

**UC012G 40cm** **40V MAX | XGT**

**Cordless Chain Saw**

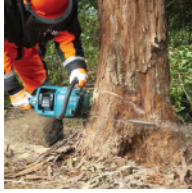
**As powerful as 42cc petrol chain saw**

- **Outer Rotor BL Brushless motor** direct-drive system delivers 0-24.8 m/s
- Excellent work efficiency
- **With Captive nuts** for solid bar retention
- Kickback brake and Variable speed trigger switch provide high operability
- **Wet Guard** - High water-resistance allows to operate the machine even if it is wet with water



<b>Guide Bar Length</b>	400 mm (16")
<b>Chain Pitch / Chain Gauge</b>	0.325 1.1mm / .043"
<b>Chain Speed</b>	0-25.5 m/s
<b>Chain Oil Tank Volume</b>	260 mL
<b>Sound Power Level</b>	104dB(A)
<b>Vibration Level (Front/ Rear)</b>	3.4/ 4.4 m/s <sup>2</sup> (saw chain: 90PX)
<b>Dimensions (L x W x H)</b>	w/o guide bar: 445 x 230 x 275 mm (17-1/2 x 9 x 10-7/8")
<b>Overall length</b>	708 mm
<b>Net weight</b>	4.5kg (without guide bar and battery)

**Standard Equipment:** 40cm Guide Bar and Chain with 1.1mm Gauge / 3/8" Pitch / 80TXL MC

**AVAILABLE VARIANTS**

5.0Ah	"Z" VARIANT
<b>UC012G T1</b> - 1 x BL4050F BATTERY - DC40RA CHARGER	<b>UC012G Z</b> TOOL ONLY (DOES NOT INCLUDE BATTERY / CHARGER)

**UC002G 25cm** **40V MAX | XGT**

**Cordless Chain Saw**



**As powerful as 30cc petrol chain saw**

- **Outer Rotor BL Brushless motor** direct-drive system delivers 0-24.8 m/s
- Lightweight design & Excellent work efficiency
- **With Captive nuts** for solid bar retention
- Kickback brake and Variable speed trigger switch provide high operability
- **Wet Guard** - High water-resistance allows to operate the machine even if it is wet with water



<b>Guide Bar Length</b>	250 mm (10")
<b>Chain Pitch / Chain Gauge</b>	6.35mm (1/4") / 1.3 mm or 9.5 mm (3/8") / 1.1or 1.3 mm
<b>Chain Speed</b>	0-24.8 m/s
<b>Chain Oil Tank Volume</b>	200 mL
<b>Sound Power Level</b>	100dB(A)
<b>Vibration Level (Front/ Rear)</b>	2.9/ 2.4 m/s <sup>2</sup> (saw chain: 90PX)
<b>Dimensions (L x W x H)</b>	266 x 194 x 227 mm (without battery)
<b>Overall length</b>	486mm (with guide bar)
<b>Net weight</b>	2.6kg (without guide bar and battery)



**Standard Equipment:** 25cm Guide Bar and Chain with 1.3mm Gauge / 3/8" Pitch / 91PX CC

**AVAILABLE VARIANTS**

4.0Ah	"Z" VARIANT
<b>UC002G M1</b> - 1 x BL4040 BATTERY - DC40RA CHARGER	<b>UC002G Z</b> TOOL ONLY (DOES NOT INCLUDE BATTERY / CHARGER)

**DUC405 40cm** **18Vx2 LXT**

**Cordless Chain Saw**

**Cordless chain saws powered by two 18V Li-ion batteries**

- **Outer Rotor BL Brushless motor** direct-drive system delivers 0-20 m/s
- **With Captive nuts** for solid bar retention
- Kickback brake and Variable speed trigger switch provide high operability
- Main power switch with auto power-off function for battery saving and avoiding unintentional start up



<b>Guide Bar Length</b>	400 mm (16")
<b>Cutting Length</b>	370 mm
<b>Chain Pitch</b>	3/8"
<b>Chain Gauge</b>	1.1 / 1.3 mm
<b>Chain Speed</b>	0 - 20 m/s
<b>Chain Oil Tank Volume</b>	200 mL
<b>Sound Pressure / Power Level</b>	87.7 dB(A) / 100.4 dB(A)
<b>Vibration Level</b>	Cutting Wood: 5.3 m/s <sup>2</sup>
<b>Dimensions (L x W x H)</b>	800x211x235 mm
<b>Net weight</b>	4.4 kg (without battery)



**Standard Equipment:** 40cm Guide Bar and Chain with 1.3mm Gauge / 3/8" Pitch / 90SG SC

**AVAILABLE VARIANTS**

5.0Ah	"Z" VARIANT
<b>DUC405 PT2</b> INCLUDES 2 BATTERIES / 1 TWO PORT CHARGER	<b>DUC405 Z</b> TOOL ONLY (DOES NOT INCLUDE BATTERY / CHARGER)

**DUC252 25cm** **18Vx2 LXT**

**Cordless Chain Saw**

**Cordless chain saws powered by two 18V Li-ion batteries**

- Tool-less chain adjustment for convenient operation and maintenance
- Kickback brake & electric brake for maximum productivity and maximum operator safety
- Soft grip top handle is engineered for the user to more easily apply even cutting pressure
- Adjustable automatic chain lubrication with large oil reservoir
- Soft start feature gradually increases speed to eliminate start up shock



<b>Guide Bar Length</b>	250 mm (10")
<b>Chain Pitch</b>	3/8"
<b>Chain Gauge</b>	1.3 mm
<b>Chain Speed</b>	8.3 m/s
<b>Chain Oil Tank Volume</b>	85 mL
<b>Dimensions (L x W x H)</b>	545x234x198 mm
<b>Net weight</b>	3.4 kg (without guide bar and battery)

**Standard Equipment:** 25cm Guide Bar and Chain with 1.3mm Gauge / 3/8" Pitch / 91PX CC

**AVAILABLE VARIANTS**

"Z" VARIANT
<b>DUC252 Z</b> TOOL ONLY (DOES NOT INCLUDE BATTERY / CHARGER)

- DRILLING / FIXING
- CONCRETE DRILLING / DEMOLITION
- MIXING / STIRRING
- CUTTING (CONCRETE / METAL)
- GRINDING
- SANDING / POLISHING
- SAWING
- MULTI-TOOL
- ROUTERS / PLANERS
- NAILERS / STAPLERS
- HEAT GUN / LASER
- CLEANING
- OPE
- JOB SITE TOOLS
- SPECIALTY TOOLS
- HAND TOOLS / COMBINATION SET
- TOOL HOLDERS AND POUCHES / MAKPAC SYSTEM

DRILLING / FIXING
CONCRETE DRILLING / DEMOLITION
MIXING / STIRRING
CUTTING (CONCRETE / METAL)
GRINDING
SANDING / POLISHING
SAWING
MULTI-TOOL
ROUTERS / PLANERS
NAILERS / STAPLERS
HEAT GUN / LASER
CLEANING
OPE
JOBSITE TOOLS
SPECIALTY TOOLS
HAND TOOLS / COMBINATION SET
TOOL HOLDERS AND POUCHES / MAKPAC SYSTEM

**DUC307** 30cm 18V | **LXT**

**Cordless Chain Saw**



**Runs at lower rpm yet with higher torque**

- Tool-less change and tension adjustment of saw chainLock-off button
- Large oil tank cap allows for easy chain oil filling
- Guide Bar Length: 300mm and Saw Chain Type: 90PX

<b>Guide Bar Length</b>	300 mm (12")
<b>Chain speed</b>	7.7 m/s
<b>Chain Pitch / Chain Gauge</b>	3/8" / 1.1 mm (0.043") or 1.3 mm (0.050")
<b>Chain oil tank volume</b>	150 mL
<b>Vibration Level</b>	5.4m/s2
<b>Dimensions (L x W x H)</b>	w/o Guide Bar: 428 x 214 x 234 mm
	w/ Guide bar/saw chain: 704 x 214 x 234 mm
<b>Net weight</b>	3.7 kg (without battery)

**Standard Equipment:** 30cm Guide Bar and Chain with 1.3mm Gauge / 3/8" Pitch / 90PX CC

**AVAILABLE VARIANTS**

5.0Ah	"Z" VARIANT
<b>DUC307 RT</b> INCLUDES 1 BATTERY / 1 FAST CHARGER	<b>DUC307 Z</b> TOOL ONLY (DOES NOT INCLUDE BATTERY / CHARGER)

**DUC254** 25cm 18V | **LXT**

**Cordless Chain Saw**



**Cordless chain saws powered by 18V Li-ion battery**

- Outer Rotor BL Brushless motor direct-drive system delivers 0-24 m/s
- With Captive nuts for solid bar retention
- Chain brake and Variable speed trigger switch provide high operability equivalent to engine chain saw.
- Torque boost mode provides more power for cutting thick branches/hard branches.

<b>Guide Bar Length</b>	250 mm (10")
<b>Chain Pitch / Chain Gauge</b>	3/8" / 1.1 mm
	3/8" / 1.3 mm
<b>Chain Speed</b>	0 - 24 m/s
<b>Chain Oil Tank Volume</b>	140 mL
<b>Sound Pressure Level</b>	92.2 dB(A)
<b>Sound Power Level</b>	103.2 dB(A)
<b>Vibration Level</b>	Cutting Wood: 3.1 m/s <sup>2</sup>
<b>Dimensions (L x W x H)</b>	258x184x191 mm (without guide bar)
<b>Net weight</b>	2 kg (without guide bar and battery)

**Standard Equipment:** 25cm Guide Bar and Chain with 1.1mm Gauge / 3/8" Pitch / 90PX CC

**AVAILABLE VARIANTS**

"Z" VARIANT
<b>DUC254 Z</b> TOOL ONLY (DOES NOT INCLUDE BATTERY / CHARGER OR CARRY CASE)

**DUC101** 10cm 18V | **LXT**

**Cordless Pruning Saw**



**For use in a variety of outdoor applications such as pruning and cutting branches or small trees**

- Brushless motor for efficient and powerful cutting
- Tool-less chain adjustment for easy maintenance
- Automatic oiling system to keep the chain lubricated
- Electric brake for added safety
- Two-handed operation for improved control
- Lock-off lever accessible from both sides
- Comes with 100mm (10") Guide bar and Saw chain (80 TX)

<b>Guide bar length</b>	100 mm (4")
<b>Chain speed</b>	8.0 m/s
<b>Chain oil tank volume</b>	55 mL
<b>Dimensions (L x W x H)</b>	394 x 90 x 245 mm
<b>Net weight</b>	1.3 kg

**Standard Equipment:** Saw Chain, Guide Bar, Guide Bar Cover, Round File

**AVAILABLE VARIANTS**

3.0Ah	"Z" VARIANT
<b>DUC101 RF</b> INCLUDES 1 BATTERY / FAST CHARGER	<b>DUC101 Z</b> TOOL ONLY (DOES NOT INCLUDE BATTERY / CHARGER)

**UC100D** 10cm 12V MAX | **CXT**

**Cordless Pruning Saw**



**For use in a variety of outdoor applications such as pruning and cutting branches or small trees**

- Brushless motor for efficient and powerful cutting
- Tool-less chain adjustment for easy maintenance
- Automatic oiling system to keep the chain lubricated
- Electric brake for added safety
- Two-handed operation for improved control
- Lock-off lever accessible from both sides
- Comes with 100mm (10") Guide bar and Saw chain (80 TX)

<b>Guide bar length</b>	100 mm (4")
<b>Chain speed</b>	8.0 m/s
<b>Chain oil tank volume</b>	55 mL
<b>Dimensions (L x W x H)</b>	357 x 90 x 215 mm
<b>Net weight</b>	1.2kg

**Standard Equipment:** Saw Chain, Guide Bar, Guide Bar Cover, Round File

**AVAILABLE VARIANTS**

2.0Ah	"Z" VARIANT
<b>UC100D WA</b> INCLUDES 1 BATTERY / CHARGER	<b>UC100D Z</b> TOOL ONLY (DOES NOT INCLUDE BATTERY / CHARGER)

**EA3502S40B 40cm**

**Petrol Chain Saw**



**Entry class chain saw for home and garden with more power.**

- Rapid start and Touch & Stop switch for easy operating.
- Environment-friendly 2-stroke engine.
- Compact and lightweight body for better handling.
- Metal spike bumper firmly grips workpiece to provide more control, making cutting easier



Standard guide bar	400mm (6")
Saw chain	Pitch : 3/8" Gauge : 1.1mm / 1.3mm
Displacement	35.0mL
Engine power	1.7kW / 2.4PS
Fuel tank	0.4 L
Chain oil tank	0.29 L
Vibration level Front handle	4.9m/s <sup>2</sup>
Vibration level Rear handle	5.0m/s <sup>2</sup>
Dimensions (L x W x H)	415x247x273mm
Power head weight	4.4kg

**Standard Equipment:** 40cm Guide Bar and Chain with 1.3mm Gauge / 3/8" Pitch / 90SG SC

**EA6100P 50cm**

**Petrol Chain Saw**



**3.4 kW (4.6 HP) professional chain saw**

- Magnesium housing for improved durability and less weight
- Easy Start spring-assisted starter for quick starting with less force
- Heavy-duty cyclonic-cartridge air filter system for improved durability
- Touch & Stop single lever control shuts off engine with just a touch
- Stratified scavenging system complying with many exhaust emission regulations
- Perfect saw for felling and debranching in one machine
- Low-vibration system with damper springs to absorb vibration from engine



Saw chain	Pitch : 0.325 or 3/8" Gauge: 1.5 mm (0.058")
Displacement	60.7 mL
Engine power	3.4 kW / 4.6 PS
Fuel Tank Capacity	0.8 L
Chain Oil Tank Volume	0.48 L
Sound Pressure Level	105 dB(A)
Sound Power Level	117 dB(A)
Vibration Level Front Grip	5.0 m/s <sup>2</sup>
Vibration Level Rear Grip	4.0 m/s <sup>2</sup>
Dimensions (L x W x H)	435x243x312 mm
Power head weight	6.0 kg

**Standard Equipment:** 50cm Guide Bar and Chain with 1.5mm Gauge / 3/8" Pitch / 91VG SC

**UC4551A 45cm**



**Electric Chain Saw**



**New adjustment lever for easier Tool-less tension adjustment of saw chain.**

- Improved oil pump keeps the delivery of chainoil constant regardless of temperature and the oil viscosity.
- Large view window of oil tank allows operator to easily check oil level.
- Large separate-type metal spike bumper.
- Longitudinal motor provides better maneuverability.
- Electronic control: Soft start and current limiter



Continuous rating input	1,800W
Chain speed per minute	870m/min
Guide bar length	450mm (18")
Chain blade	Pitch : 3/8" Gauge : 0.050"
Sound pressure level	90.8dB(A)
Sound power level	101.8dB(A)
Vibration level	5.2m/s <sup>2</sup>
Dimensions (L x W x H)	505x200x220mm (19-7/8" x7-7/8" x8-5/8")
Net weight	5.7kg (12.5lbs)
Power supply cord	0.3m (0.98ft)

**Standard Equipment:** Chain blade, Guide bar cover, Hook complete, Wrench

**UC4041A 40cm**



**Electric Chain Saw**



**New adjustment lever for easier Tool-less tension adjustment of saw chain.**

- Improved oil pump keeps the delivery of chainoil constant regardless of temperature and the oil viscosity.
- Large view window of oil tank allows operator to easily check oil level.
- Large separate-type metal spike bumper.
- Flat motor housing end.
- Easy-to-grip Front loop handle.



Continuous rating Input	1,800W
Chain speed per minute	870m/min (2,900ft/min)
Guide bar length	400mm (16")
Chain blade	Pitch : 3/8" Gauge : 1.1mm (.043") / or 1.3mm (.050")
Sound pressure level	90.3dB(A)
Sound power level	101.3dB(A)
Vibration level	4.7m/s <sup>2</sup>
Dimensions (L x W x H)	455x245x200mm (17-7/8" x9-5/8" x7-7/8")
Net weight	4.7kg (10.5lbs)

**Standard Equipment:** Chain blade, Guide bar cover, Hook complete, Wrench

DRILLING / FIXING

CONCRETE DRILLING / DEMOLITION

MIXING / STIRRING

CUTTING (CONCRETE / METAL)

GRINDING

SANDING / POLISHING

SAWING

MULTI-TOOL

ROUTERS / PLANERS

NAILERS / STAPLERS

HEAT GUN / LASER

CLEANING

OPE

JOBSITE TOOLS

SPECIALTY TOOLS

HAND TOOLS / COMBINATION SET

TOOL HOLDERS AND POUCHES / MAKPAC SYSTEM

- DRILLING / FIXING
- CONCRETE DRILLING / DEMOLITION
- MIXING / STIRRING
- CUTTING (CONCRETE / METAL)
- GRINDING
- SANDING / POLISHING
- SAWING
- MULTI-TOOL
- ROUTERS / PLANERS
- NAILERS / STAPLERS
- HEAT GUN / LASER

## Telescopic Pole Saw

### Ideal for pruning and limbing in tall trees or hard-to-reach areas

- Tool-less pole extension and fixing for easy adjustment of pole length
- Designed to provide high performance similar to 30ml class engine pole saws
- Excellent tool balance - The motor is located in the battery housing, this reducing the saw head weight allowing for easier control of the saw head.
- Retractable oil tank cap decreases the chance that the saw head will be snagged in branches
- LXT model DUA301 is featured with torque boost mode raises the current limit temporarily similar to XGT model UA004G for easy cutting of trunks or thick limbs

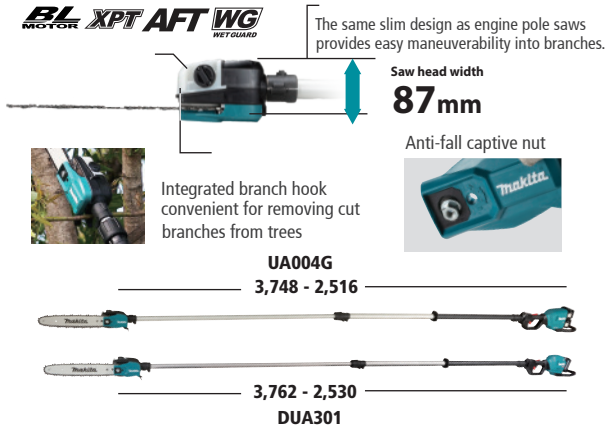

UA004G		40V MAX   XGT
<b>Cordless Telescopic Pole Saw</b>		
<b>Max output: kW</b>	1.5 kW	
<b>Guide Bar Length</b>	300mm (12")	
<b>Saw chain</b>	Gauge : 1.1mm / Pitch: 3/8"	
<b>Chain Speed</b>	0 - 20.0 m/s	
<b>Fuel Tank</b>	-	
<b>Oil Tank Capacity</b>	160 mL	
<b>Dimensions (L x W x H) w/o Guide Bar</b>	2,515 - 3,747 x 157 x 191 mm	
<b>Net weight w/o Guide Bar</b>	6.4kg (without battery)	
<b>Standard Equipment:</b> 30cm Guide Bar and Chain with 1.1mm Gauge / 3/8" Pitch / 90PX CC		
<b>AVAILABLE VARIANTS</b>		
<b>4.0Ah "Z" VARIANT</b>		
<b>UA004G M1</b>	<b>UA004G Z</b>	
- 1 x BL4040 - DC40RA CHARGER	TOOL ONLY (DOES NOT INCLUDE BATTERY / CHARGER)	

DUA301		18Vx2   LXT
<b>Cordless Telescopic Pole Saw</b>		
<b>Max output: kW</b>	1.5 kW	
<b>Guide Bar Length</b>	300mm (12")	
<b>Saw chain</b>	Gauge : 1.1 mm / Pitch: 3/8"	
<b>Chain Speed</b>	0 - 20.0 m/s	
<b>Fuel Tank</b>	-	
<b>Oil Tank Capacity</b>	160 mL	
<b>Dimensions (L x W x H) w/o Guide Bar</b>	2,530 - 3,762 x 155 x 191 mm	
<b>Net weight w/o Guide Bar</b>	6.4 kg (without battery)	
<b>Standard Equipment:</b> 30cm Guide Bar and Chain with 1.1mm Gauge / 3/8" Pitch / 90PX CC		
<b>AVAILABLE VARIANTS</b>		
<b>5.0Ah "Z" VARIANT</b>		
<b>DUA301 PT2</b>	<b>DUA301 Z</b>	
- 2PCS x BL1850B - DC18RC CHARGER	TOOL ONLY (DOES NOT INCLUDE BATTERY / CHARGER)	

DUP362		18Vx2   LXT
<b>Cordless Pruning Shear</b>		
<b>18V X2 (36V) LXT Li-Ion Battery Powered Pruning Shear</b>		
<ul style="list-style-type: none"> <li>• Higher torque for increased cutting performance</li> <li>• Smooth cutting similar to that of a hand pruner</li> <li>• Extra sharp, made-in-Japan forged blade</li> <li>• Comfortable backpack harness with Switch box and Controller box</li> </ul>		
<b>Capacity</b>	Max cutting : 33 mm / Max blade opening : 54 mm	
<b>Cutting Torque</b>	250 N	
<b>Dimensions (L x W x H)</b>	305x43x106 mm	
<b>Net weight</b>	0.8 kg	
<b>Standard Equipment:</b> Wrench set, Holster, Harness, Arm Band		
<b>AVAILABLE VARIANTS</b>		
<b>"Z" VARIANT</b>		
<b>DUP362 Z</b>	<b>TOOL ONLY</b>	
(DOES NOT INCLUDE BATTERY / CHARGER)		

UP100D		12V MAX   CX1
<b>Cordless Pruning Shear</b>		
<b>The opening angle of the shear blades can be set in two levels</b>		
<ul style="list-style-type: none"> <li>• BL motor provide high power and excellent cutting performance</li> <li>• Adjustment of blade overlap when closed</li> <li>• Anti-vibration structure</li> <li>• Wet Guard - High water-resistance allows to operate the machine even if it is wet with water</li> </ul>		
Adjustment of blade opening angle		
<b>Max Cutting Capacity</b>		
Max cutting: 25 mm (1")		<b>Work Amount</b> <b>2,200 Cuts</b> with BL1021B When cutting ø15mm branches
<b>Dimensions (L x W x H)</b>		
259 x 53 x 98 mm		
<b>Net weight</b>		
1.1 kg (With 4.0Ah battery)		
<b>Standard Equipment:</b> Blade Cover, Chip Receiver		
<b>AVAILABLE VARIANTS</b>		
<b>4.0Ah "Z" VARIANT</b>		
<b>UP100D SMJ</b>	<b>UP100D Z</b>	
- 2PCS OF BL1041B BATTERY - DC105B CHARGER AND MAKPAC CASE	TOOL ONLY (DOES NOT INCLUDE BATTERY / CHARGER)	



# Hedge Trimmer



	MODELS	BLADE DIA.	BL MOTOR	Sharp edge blade, (Smooth cutting of thin branches)	Sharp edge curved blade, (Rough cutting of thick branches)	Standard Blade	Maximum branch diameter	Twigs are caught easily and held firmly	Reverse rotation system	5 position rotating rear handle	Highly durable crank mechanism	Anti-vibration structure
	UH007G	750mm	•	•			25.5mm	•	•	•		•
	UH005G		•		•		23.5mm	•	•	•		•
	DUH551	550mm				•	18mm			•		
	DUH751	750mm	•		•			•	•	•		•
	DUH606	600mm	•			•	20mm				•	•
	DUH607					•	15mm				•	•
	DUH507		500mm				•	15mm				•

## SINGLE SIDE BLADE MODELS



	UH014G	750mm	•	•			23.5mm	•	•			•
	DUH754S	750mm	•	•			23.5mm	•	•			•

## POLE HEDGE TRIMMERS



	DUN500W	500mm	•	•			23.5mm	•	•			•
	DUN461W	460mm				•	18.0mm					•
	UN460DW	460mm				•	18.0mm					

- DRILLING / FIXING
- CONCRETE DRILLING / DEMOLITION
- MIXING / STIRRING
- CUTTING (CONCRETE / METAL)
- GRINDING
- SANDING / POLISHING
- SAWING
- MULTI-TOOL
- ROUTERS / PLANERS
- NAILERS / STAPLERS
- HEAT GUN / LASER
- CLEANING
- OPE
- JOB SITE TOOLS
- SPECIALTY TOOLS
- HAND TOOLS / COMBINATION SET
- TOOL HOLDERS AND POUCHES / MAKPAC SYSTEM

- DRILLING / FIXING
- CONCRETE DRILLING / DEMOLITION
- MIXING / STIRRING
- CUTTING (CONCRETE / METAL)
- GRINDING
- SANDING / POLISHING
- SAWING
- MULTI-TOOL

**UH005G - 750 mm** 40V MAX |

**Cordless Hedge Trimmer**

**Runtime**  
**365 / 155 / 80min**  
 Low / Medium / High  
with BL4040

**Reliable cutting performance superior to engine hedge trimmers**  
**High power and longer runtime achieved with XGT battery**

- Sharp edge curved blade - Ideal for smoothly and efficiently trimming twigs, thin branches or dense hedges
- BL motor provide high power and excellent cutting performance
- 5 position rotating rear handle
- Anti-vibration structure
- Wet Guard - High water-resistance allows to operate the machine even if it is wet with water

(Sharp edge curved Blade)

<b>Blade Length</b>	750 mm
<b>Max Cutting Capacity</b>	23.5 mm
<b>Strokes Per Minute (SPM)</b>	High / Mid / Low: 5,000 / 3,600 / 2,000
<b>Sound Pressure Level</b>	86 dB(A)
<b>Sound Power Level</b>	97 dB(A)
<b>Vibration Level</b>	Front / Rear: 3.1 / 2.7
<b>Dimensions (L x W x H)</b>	1,263 x 223 x 191 mm
<b>Net weight</b>	3.8 kg (without battery)

**Standard Equipment:** Blade Cover, Chip Receiver

AVAILABLE VARIANTS

4.0Ah	"Z" VARIANT
<b>UH005G M2</b> <small>- 2PCS OF BL4040 BATTERY - DC40RA CHARGER</small>	<b>UH005G Z</b> <small>TOOL ONLY (DOES NOT INCLUDE BATTERY / CHARGER)</small>

- ROUTERS / PLANERS
- NAILERS / STAPLERS
- HEAT GUN / LASER
- CLEANING
- OPE
- JOBSITE TOOLS
- SPECIALTY TOOLS
- HAND TOOLS / COMBINATION SET
- TOOL HOLDERS AND POUCHES / MAKPAC SYSTEM

**UH007G - 750 mm** 40V MAX |

**Cordless Hedge Trimmer (for rough cut)**

**Runtime**  
**180 / 105 / 65min**  
 Low / Medium / High  
with BL4040

**Reliable cutting performance superior to engine hedge trimmers**

- Sharp edge Blade - Ideal for trimming overgrown hedges and trimming thick and hard branches
- BL motor provide high power and excellent cutting performance
- 5 position rotating rear handle
- Anti-vibration structure
- Wet Guard - High water-resistance allows to operate the machine even if it is wet with water

(Sharp edge Blade)

<b>Blade Length</b>	750 mm
<b>Max Cutting Capacity</b>	25.0 mm
<b>Strokes Per Minute (SPM)</b>	High / Mid / Low: 4,000 / 3,000 / 2,000
<b>Sound Pressure Level</b>	81 dB(A)
<b>Sound Power Level</b>	92 dB(A)
<b>Vibration Level</b>	Front / Rear: 3.4 / 3.1
<b>Dimensions (L x W x H)</b>	1,274 x 223 x 191 mm
<b>Net weight</b>	3.9 kg (without battery)

**Standard Equipment:** Blade Cover, Chip Receiver

AVAILABLE VARIANTS

4.0Ah	"Z" VARIANT
<b>UH007G M2</b> <small>- 2PCS OF BL4040 BATTERY - DC40RA CHARGER</small>	<b>UH007G Z</b> <small>TOOL ONLY (DOES NOT INCLUDE BATTERY / CHARGER)</small>

**UH014G - 750 mm** 40V MAX |

**Cordless Hedge Trimmer (Single side blade)**

**High performance as petrol hedge trimmer**  
**Easy-to-use Front handle**

- Anti-vibration structure
- Optimum blade shape for smooth cutting
- Twigs are caught easily and held firmly
- High performance with brushless motor

Front handle  
 Handle end

<b>Blade Length</b>	750 mm
<b>Tooth Spacing</b>	35 mm
<b>Max Branch Capacity</b>	23.5 mm
<b>Max Cutting Capacity</b>	18 mm
<b>Strokes Per Minute (SPM)</b>	High / Med / Low: 5,000 / 3,600 / 2,000
<b>Continuous Use (min.)</b>	w/ BL4040 High / Med / Low: 80 / 155 / 380
<b>Sound Pressure / Power Level</b>	81 dB(A) / 92 dB(A)
<b>Vibration Level Front Grip</b>	3.2 m/s²
<b>Dimensions (L x W x H)</b>	1,225 x 270 x 135 mm (without battery)
<b>Net weight</b>	3.4kg (without battery)

**Standard Equipment:** Blade Cover, Chip Receiver

AVAILABLE VARIANTS

4.0Ah	"Z" VARIANT
<b>UH014G M1</b> <small>- 1PC OF BL4040 XGT BATTERY - FAST CHARGER DC40RA</small>	<b>UH014G Z</b> <small>TOOL ONLY (DOES NOT INCLUDE BATTERY / CHARGER)</small>

**DUH551 550 mm** 18Vx2

**Cordless Hedge Trimmer**

**Runtime**  
**125-75min**  
BL1850B x2

**High maneuverability and environment friendly**  
**5 position adjustable handle**

for easy and fast trimming in any angle.

**Well balanced tool design**  
 by positioning the batteries at rear end of the tool.

<b>Blade length</b>	550mm (21-5/8")
<b>Strokes per minute(spm)</b>	2,000-3,600
<b>Sound pressure level</b>	81.5dB(A)
<b>Sound power level</b>	91dB(A)
<b>Dimensions (L x W x H)</b>	1,065 x 225 x 200mm
<b>Max. output</b>	0.32kW
<b>Net weight</b>	5.1kg (11.3lbs)

**Standard Equipment:** Blade cover.

AVAILABLE VARIANTS

"Z" VARIANT
<b>DUH551 Z</b> <small>TOOL ONLY (DOES NOT INCLUDE BATTERY / CHARGER)</small>

**DUH751 - 750 mm** 18V | **LXT**

**Cordless Hedge Trimmer (Twin blade)**



**Runtime**  
**160 / 70 / 45 min**  
Low / Medium / High  
with BL1860B

**Reliable cutting performance superior to engine hedge trimmers**

- Sharp edge curved blade - Ideal for smoothly and efficiently trimming twigs, thin branches or dense hedges
- BL motor provide high power and excellent cutting performance
- 5 position rotating rear handle
- Anti-vibration structure



<b>Blade Length</b>	750 mm
<b>Max Cutting Capacity</b>	23.5 mm
<b>Strokes Per Minute (SPM)</b>	High / Med / Low: 0 - 4,400 / 0 - 3,600 / 0 - 2,000
<b>Sound Pressure Level</b>	84 dB(A)
<b>Sound power level</b>	97 dB(A)
<b>Vibration Level</b>	2.5 m/s <sup>2</sup>
<b>Dimensions (L x W x H)</b>	1,261x225x192 mm
<b>Net weight</b>	4.5 kg

**AVAILABLE VARIANTS**

5.0Ah	3.0Ah	"Z" VARIANT
<b>DUH751 PTE</b> 2PCS OF BATTERIES / 1PC TWO PORT CHARGER (DOES NOT INCLUDE CARRY CASE)	-	<b>DUH751 Z</b> TOOL ONLY (DOES NOT INCLUDE BATTERY / CHARGER OR CARRY CASE)

**DUH754S - 750 mm** 18V | **LXT**

**Cordless Hedge Trimmer (Single side blade)**



**18V LXT BL Cordless Hedge Trimmer with single side blade**

- Reliable cutting performance like engine/AC hedge trimmers
- The no load continuous run time on a full battery charge is the same or longer than that on a full tank of petrol



<b>Blade Length</b>	750 mm
<b>Max Cutting Capacity</b>	23.5 mm
<b>Continuous Use (min.)</b>	High: 65   Mid: 80   Low: 190 (using 6.0Ah battery)
<b>Sound Pressure Level</b>	80.6 dB(A)
<b>Sound power level</b>	91.6 dB(A)
<b>Vibration Level</b>	2.5 m/s <sup>2</sup> or less
<b>Strokes Per Minute (SPM)</b>	High / Med / Low: 4,400 / 3,600 / 2,000
<b>Dimensions (L x W x H)</b>	1,200 x 282 x 143 mm
<b>Net weight</b>	3.9 kg

**AVAILABLE VARIANTS**

5.0Ah	3.0Ah	"Z" VARIANT
		<b>DUH754S Z</b> TOOL ONLY (DOES NOT INCLUDE BATTERY / CHARGER OR CARRY CASE)

**DUH607 - 600 mm** 18V | **LXT**

**Cordless Hedge Trimmer**



**NEW**

**Runtime**  
**60 min**  
BL1830B

**Compact, Lightweight and well balanced design allows for long periods of use with minimal fatigue**

- 2 handed starting switch prevents accidental start-up
- Large main switch lever for easy operation
- Easy-to-press front handle safety that can be gripped from multiple angles
- Aluminium guide bar reduces overall weight of blade assembly
- Angled teeth for effective branch entry into cutting area
- Highly durable crank mechanism minimizes the risk of the blade falling off



<b>Blade Length</b>	600 mm
<b>Max Cutting Capacity</b>	15 mm
<b>Strokes Per Minute (SPM)</b>	2,700
<b>Continuous Use (min.)</b>	w/ BL1830B: 60
<b>Sound Pressure Level</b>	Front/Rear: 1.2/0.7 m/s
<b>Sound Power Level</b>	73 dB(A)
<b>Vibration Level</b>	84 dB(A)
<b>Dimensions (L x W x H)</b>	1,029 x 209 x 188 mm (with BL1860B)
<b>Net weight</b>	2.42 kg (without battery)

**Standard Equipment:** Blade cover.

**AVAILABLE VARIANTS**

**"Z" VARIANT**

**DUH607 Z**  
TOOL ONLY (DOES NOT INCLUDE BATTERY / CHARGER OR CARRY CASE)

**DUH507 - 500 mm** 18V | **LXT**

**Cordless Hedge Trimmer**



**NEW**

**Runtime**  
**77 min**  
BL1830B

**Compact, Lightweight and well balanced design allows for long periods of use with minimal fatigue**

- 2 handed starting switch prevents accidental start-up
- Large main switch lever for easy operation
- Easy-to-press front handle safety that can be gripped from multiple angles
- Aluminium guide bar reduces overall weight of blade assembly
- Angled teeth for effective branch entry into cutting area
- Highly durable crank mechanism minimizes the risk of the blade falling off



<b>Blade Length</b>	500 mm
<b>Max Cutting Capacity</b>	15 mm
<b>Strokes Per Minute (SPM)</b>	2,700
<b>Continuous Use (min.)</b>	with BL1830B: 77
<b>Sound Pressure Level</b>	Front/Rear: 1.1/0.6 m/s
<b>Sound Power Level</b>	74 dB(A)
<b>Vibration Level</b>	85 dB(A)
<b>Dimensions (L x W x H)</b>	925 x 209 x 188 mm (with BL1860B)
<b>Net weight</b>	2.34 kg (without battery)

**Standard Equipment:** Blade cover.

**AVAILABLE VARIANTS**

**"Z" VARIANT**

**DUH507 Z**  
TOOL ONLY (DOES NOT INCLUDE BATTERY / CHARGER OR CARRY CASE)

- DRILLING / FIXING
- CONCRETE DRILLING / DEMOLITION
- MIXING / STIRRING
- CUTTING (CONCRETE / METAL)
- GRINDING
- SANDING / POLISHING
- SAWING
- MULTI-TOOL
- ROUTERS / PLANERS
- NAILERS / STAPLERS
- HEAT GUN / LASER
- CLEANING
- OPE
- JOB SITE TOOLS
- SPECIALTY TOOLS
- HAND TOOLS / COMBINATION SET
- TOOL HOLDERS AND POUCHES / MAKPAC SYSTEM

DRILLING / FIXING
CONCRETE DRILLING / DEMOLITION
MIXING / STIRRING
CUTTING (CONCRETE / METAL)
GRINDING
SANDING / POLISHING
SAWING
MULTI-TOOL

**DUH606 - 600 mm** 18V | **LXT**

**Cordless Hedge Trimmer**

NEW







Runtime

70min

BL1860B

**BL motor, Compact, Lightweight and well balanced design allows for long periods of use with minimal fatigue**

- 2 handed starting switch prevents accidental start-up
- Large main switch lever for easy operation
- Easy-to-press front handle safety that can be gripped from multiple angles
- Aluminium guide bar reduces overall weight of blade assembly
- Angled teeth for effective branch entry into cutting area
- Highly durable crank mechanism minimizes the risk of the blade falling off

Blade Length	600 mm
Max Cutting Capacity	20.0 mm
Strokes Per Minute (SPM)	4,000
Continuous Use (min.)	w/ BL1860B: 70
Sound Pressure Level	79 dB(A)
Sound Power Level	90 dB(A)
Vibration Level	2.5 m/s or less
Dimensions (L x W x H)	1,016 x 207 x 185 mm
Net weight	2.7 kg

**Standard Equipment:** Blade cover.

AVAILABLE VARIANTS

5.0Ah	"Z" VARIANT
<b>DUH606 RT</b> 1PC OF BATTERY / FAST CHARGER	<b>DUH606 Z</b> TOOL ONLY (DOES NOT INCLUDE BATTERY / CHARGER)



ROUTERS / PLANERS
NAILERS / STAPLERS
HEAT GUN / LASER
CLEANING
OPE
JOBSITE TOOLS
SPECIALTY TOOLS
HAND TOOLS / COMBINATION SET
TOOL HOLDERS AND POUCHES / MAKPAC SYSTEM

**EH7500S 750mm**

**Petrol Hedge Trimmer (single side blade)**

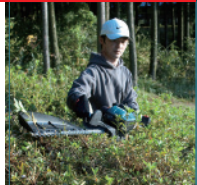
**Environment-friendly 2-stroke engine**

Anti-vibration System  
Blade Teeth with 3 Sharpened Edges



Blade length	750mm (29-1/2")
Displacement	22.2mL
Power rating	0.68kW (1.0PS)
Fuel mixture	50 : 1
Fuel tank	0.4L
Dimensions (L x W x H)	1,150mm x 323mm x 212mm (45-1/4"x12-3/4"x8-3/8")
Net weight	4.7kg(10.4lbs)

**EH7500W 750mm**

**Petrol Hedge Trimmer (double blade)**





**Environment-friendly 2-stroke engine**

Anti-vibration System  
Blade Teeth with 3 Sharpened Edges  
5 Position Rotating Rear Handle





Blade length	750mm (29-1/2")
Displacement	22.2mL
Power rating	0.68kW / 1.0PS
Fuel mixture	50 : 1
Fuel tank	0.4L
Dimensions (L x W x H)	1,259mm x 262mm x 216mm (49-1/2"x10-3/8"x8-1/2")
Net weight	5.2kg (11.4lbs)

**UH5261** 520mm 

**Electric Hedge Trimmer (2 sided blade)**



**Ergonomically designed grips provides more control and comfort while minimizing hand fatigue.**

- Stain-free shear blade surface obtained by non-electrolyzed nickel plating features high anti-abrasion surface for a long lasting coating.
- Protection of extension cord from breakage.



<b>Continuous rating Input</b>	400W
<b>Blade length</b>	520mm (20-1/2")
<b>Strokes per minute (spm)</b>	3,200
<b>Dimensions (L x W x H)</b>	921 x 194 x 194mm (36-1/4" x 7-5/8" x 7-5/8")
<b>Net weight</b>	3.0kg (6.5lbs)
<b>Power supply cord</b>	0.3m (0.98ft)

**UH6570** 650mm 

**Electric Hedge Trimmer (2 sided blade)**

**Comfortable operation by ergonomically designed rubberized soft grip.**

- Three switches are installed in handle, front grip and sub grip.
- Tool starts only when any two pair of the three switches are pressed at the same time.
- Guard is provided at the tip of blades to prevent kick-back.
- Blades are coated to improve durability.



<b>Continuous rating Input</b>	550W
<b>Blade length</b>	650mm (25-1/2")
<b>Strokes per minute (spm)</b>	3,200
<b>Dimensions (L x W x H)</b>	1,042 x 223 x 206mm (41" x 8-3/4" x 8-1/8")
<b>Net weight</b>	3.7kg (8.1lbs)
<b>Power supply cord</b>	0.3m (0.98ft)

**UH7580** 750mm 

**Electric Hedge Trimmer (2 sided blade)**



**High power and superior operation.**

- Ergonomically designed rubberized soft grips provide more control and comfort.
- Three switches are installed in handle, front grip and sub grip.
- Tool starts only when any two pair of the three switches are pressed at the same time.
- Guard is provided at the tip of blades to prevent kick-back.
- Blades are coated to improve durability.



<b>Continuous rating Input</b>	670W
<b>Blade length</b>	750mm (29-1/2")
<b>Strokes per minute (spm)</b>	3,000
<b>Dimensions (L x W x H)</b>	1,157 x 223 x 206mm (45-1/2" x 8-3/4" x 8-1/8")
<b>Net weight</b>	4.6kg (10.1lbs)
<b>Power supply cord</b>	0.3m (0.98ft)



- DRILLING / FIXING
- CONCRETE DRILLING / DEMOLITION
- MIXING / STIRRING
- CUTTING (CONCRETE / METAL)
- GRINDING
- SANDING / POLISHING
- SAWING
- MULTI-TOOL
- ROUTERS / PLANERS
- NAILERS / STAPLERS
- HEAT GUN / LASER
- CLEANING
- OPE**
- JOB SITE TOOLS
- SPECIALTY TOOLS
- HAND TOOLS / COMBINATION SET
- TOOL HOLDERS AND POUCHES / MAKPAC SYSTEM

- DRILLING / FIXING
- CONCRETE DRILLING / DEMOLITION
- MIXING / STIRRING
- CUTTING (CONCRETE / METAL)
- GRINDING
- SANDING / POLISHING
- SAWING
- MULTI-TOOL
- ROUTERS / PLANERS
- NAILERS / STAPLERS
- HEAT GUN / LASER
- CLEANING
- OPE
- JOBSITE TOOLS
- SPECIALTY TOOLS
- HAND TOOLS / COMBINATION SET
- TOOL HOLDERS AND POUCHES / MAKPAC SYSTEM

**DUN461W - 460 mm** 18V | *LXT*

**18V LXT - Cordless Pole Hedge Trimmer**

Angle adjustable hedge trimmer head  
60° to tilt-up  
75° to tilt-down

**For tall and hard to reach hedges**

- Length adjustable telescopic system
- The angle of hedge trimmer head can be changed simply by pushing a button

Can be folded in the 180° position for easy transport and storage

<b>18V XPT</b>		<b>Run time</b>
		BL1850B
		<b>122 min</b>

<b>Blade Length</b> 460 mm	<b>Max Cutting Capacity</b> 18 mm
<b>Strokes Per Minute (SPM)</b> 3,600	<b>Cycles Per Minute (CPM)</b> 1,800
<b>Dimensions (L x W x H)</b> 1,889 - 2,511 x 87 x 133 mm	
<b>Net weight</b> 2.6 kg (without battery)	

**Standard Equipment:** Blade Cover

**AVAILABLE VARIANTS**

<b>3.0Ah</b>	<b>"Z" VARIANT</b>
<b>DUN461W RF</b> 1PC BATTERY / 1PC CHARGER (DOES NOT INCLUDE CARRY CASE)	<b>DUN461W Z</b> TOOL ONLY (DOES NOT INCLUDE BATTERY / CHARGER OR CARRY CASE)

**UN460WD - 460 mm** 12V MAX | *CXT*

**12V MAX CXT - Cordless Pole Hedge Trimmer**

Angle adjustable hedge trimmer head  
60° to tilt-up  
75° to tilt-down

**For tall and hard to reach hedges**

- Length adjustable telescopic system
- The angle of hedge trimmer head can be changed simply by pushing a button

Can be folded in the 180° position for easy transport and storage

<b>12V MAX XPT</b>		<b>Run time</b>
		BL1041B
		<b>53 min</b>

<b>Blade Length</b> 460 mm	<b>Max Cutting Capacity</b> 18 mm
<b>Strokes Per Minute (SPM)</b> 3,600	<b>Cycles Per Minute (CPM)</b> 1,800
<b>Dimensions (L x W x H)</b> 1,889 - 2,511 x 87 x 133 mm	
<b>Net weight</b> 3.0 kg	

**Standard Equipment:** Blade Cover

**AVAILABLE VARIANTS**

<b>"Z" VARIANT</b>	
<b>UN460WD Z</b> TOOL ONLY (DOES NOT INCLUDE BATTERY / CHARGER OR CARRY CASE)	

**DUN500W 500 mm** 18V | *LXT*

**18V LXT - Cordless Pole Hedge Trimmer**

(Curved blades)

**Cutting blade angle: 115° foldable for easy transport and storage:**

- New triple-edged cutting teeth are designed to easily catch and firmly hold twigs, also featuring excellent sharpness
- Curved blades reduce friction resistance to suppress energy loss.
- Reverse rotation system frees the blade when it is jammed by thick branches

<b>Blade Length</b> 500 mm (19-3/4")	<b>Max Cutting Capacity</b> 23.5 mm (15/16")
<b>Sound Pressure Level</b> 81.5 dB(A)	<b>Sound Power Level</b> 92.5 dB (A)
<b>Vibration Level: Left hand (Front grip / Handle)</b> 4.7 m/s <sup>2</sup>	
<b>Vibration Level: Right hand (Rear grip)</b> 2.5 m/s <sup>2</sup> or less	
<b>Strokes Per Minute (SPM)</b> High / Med / Low: 4,400 / 3,600 / 2,000	
<b>Overall length</b> 2,115 mm	
<b>Net weight</b> 4.5 kg	

**Standard Equipment:** Blade Cover, Harness

**AVAILABLE VARIANTS**

<b>6.0Ah</b>	<b>"Z" VARIANT</b>
<b>DUN500W RGE</b> 2PCS OF BATTERIES / 1PC CHARGER (DOES NOT INCLUDE CARRY CASE)	<b>DUN500W Z</b> TOOL ONLY (DOES NOT INCLUDE BATTERY / CHARGER OR CARRY CASE)

**EN4950H 490mm**

**Petrol Pole Hedge Trimmer**

**4-stroke engine with the multi-position engine lubrication system**

- Compact design for greater versatility in the garden as well as in commercial applications
- Angle adjustable hedge trimmer head
- 45° tilt-up to 90° tilt-down from the horizontal position
- Blade does not move while hedge trimmer head is 180° in the folded position
- 180° foldable for easy transport and storage
- 13 angle settings (11.25° each):

<b>Blade length</b> 490mm(19-1/4")	<b>Displacement</b> 25.4mL
<b>Engine power</b> 0.77kW / 1.1PS	<b>Fuel tank</b> 0.6L
<b>Strokes per minute (spm)</b> 4,200	<b>Sound pressure level</b> 90dB(A)
<b>Sound power level</b> 102.2dB(A)	<b>Vibration level Front handle</b> 6.3m/s <sup>2</sup>
<b>Vibration level Rear handle</b> 8.9m/s <sup>2</sup>	<b>Dimensions (L x W x H)</b> 2,550x242x241mm
<b>Net weight</b> 6.9kg (15lbs)	<b>Net weight</b> 6.9kg (15lbs)

**Standard Equipment:** Blade cover, Box driver, Accessory bag, Oil set, Shoulder strap, Safety goggles, End cover set, Hex wrench

# Grass Shears



**GRASS CUTTING**

2-TOOLS IN ONE



**HEDGE TRIMMING**

Grass shears can be easily converted to hedge trimmer by simply replacing the grass shear blade with the optional hedge trimmer blade for a wide variety of purposes

**DUM604**
18V | **LXT**

Cordless Grass Shear







Hedge trimmer blade (only with "Z" Variant) Part No.198409-9

18V LXT Li-Ion Cordless 160mm Grass Shear

- Ergonomically designed handle with sure grip provides more control and comfort
- Grass receiver for reduced grass clean-ups
- Up to 250 min of run time with BL1860B
- 2,500 SPM for efficient cutting
- 2 in 1: Both trimmer blade and shear blade can be attached

	
<b>Cutting Width</b>	160 mm
<b>Depth Adjustment</b>	15, 20, 25 mm
<b>Strokes Per Minute (SPM)</b>	2,500
<b>Continuous Use (min.)</b>	with BL1860B / BL1850B / BL1830B: 250 / 200 / 125min
<b>Sound Pressure Level</b>	76 dB(A)
<b>Vibration Level</b>	2.5 m/s <sup>2</sup> or less
<b>Dimensions (L x W x H)</b>	337x177x131 mm
<b>Net weight</b>	1.8 kg

**Standard Equipment:** Grass shear blade, Grass Receiver, Blade Cover , Hedge Trimmer Blade (only with "z" variant)

AVAILABLE VARIANTS

5.0Ah	"Z" VARIANT
DUM604 RT	DUM604 ZX
INCLUDES 1 BATTERIES / 1 CHARGER + GRASS SHEAR BLADE	TOOL + GRASS SHEAR BLADE + HEDGE TRIMMER BLADE ONLY (DOES NOT INCLUDE BATTERY / CHARGER)

**DUM111**
18V | **LXT**

Cordless Grass Shear







Hedge trimmer blade included Part No.191N24-2

18V LXT Li-Ion Cordless 110mm Grass Shear

- Ergonomically designed handle with sure grip provides more control and comfort
- Grass receiver for reduced grass clean-ups
- Up to 67 min of run time with BL1815N
- 2,500 SPM for efficient cutting
- 2 in 1: Both trimmer blade and shear blade can be attached

	
<b>Cutting Width</b>	Grass Shear Blade: 110 mm / Hedge Trimmer Blade: 200 mm
<b>Depth Adjustment</b>	15, 20, 25 mm
<b>Strokes Per Minute (SPM)</b>	2,500
<b>Continuous Use (min.)</b>	67 (w/ BL1815N)
<b>Sound Pressure Level</b>	70 dB(A)
<b>Vibration Level</b>	2.5 m/s <sup>2</sup> or less
<b>Dimensions (L x W x H)</b>	300 x 120 x 130 mm
<b>Net weight</b>	1.4 kg

**Standard Equipment:** Grass Receiver, Blade Cover

AVAILABLE VARIANTS

1.5Ah
DUM111 SYX
INCLUDES 1 BATTERY / 1 CHARGER DC18SD + GRASS SHEAR BLADE + HEDGE TRIMMER BLADE

**UM600D**
12V MAX | **CXT**

Cordless Grass Shear







Hedge trimmer blade (only with "Z" Variant) Part No.198409-9

12V max CXT Li-Ion Cordless 16 cm Grass Shear

- Slimmer handle. More runtime. High performance
- Ergonomically designed handle with sure grip provides more control and comfort
- Up to 90 min of run time on a single battery BL1041B charge
- 2,500 SPM for efficient cutting
- 2 in 1: Both trimmer blade and shear blade can be attached

	
<b>Cutting Width</b>	160 mm (6-5/16")
<b>Depth Adjustment</b>	15, 20, 25 mm
<b>Strokes Per Minute (SPM)</b>	2,500
<b>Continuous Use (min.)</b>	with BL1041B / BL1021B : 90 / 45min
<b>Sound Pressure Level</b>	75 dB(A)
<b>Vibration Level</b>	2.5 m/s <sup>2</sup> or less
<b>Dimensions (L x W x H)</b>	329x177x131 mm
<b>Net weight</b>	1.5 kg

**Standard Equipment:** Grass shear blade, Grass Receiver, Blade Cover , Hedge Trimmer Blade (only with "z" variant)

AVAILABLE VARIANTS

4.0Ah	"Z" VARIANT
UM600D SM	UM600D ZX
INCLUDES 1 BATTERIES / 1 CHARGER + GRASS SHEAR BLADE	TOOL + GRASS SHEAR BLADE + HEDGE TRIMMER BLADE ONLY (DOES NOT INCLUDE BATTERY / CHARGER)

- DRILLING / FIXING
- CONCRETE DRILLING / DEMOLITION
- MIXING / STIRRING
- CUTTING (CONCRETE / METAL)
- GRINDING
- SANDING / POLISHING
- SAWING
- MULTI-TOOL
- ROUTERS / PLANERS
- NAILERS / STAPLERS
- HEAT GUN / LASER
- CLEANING
- OPE
- JOBSITE TOOLS
- SPECIALTY TOOLS
- HAND TOOLS / COMBINATION SET
- TOOL HOLDERS AND POUCHES / MAKPAC SYSTEM



# Brush Cutter / Grass Trimmer

	<b>XGT 80V<sup>max</sup></b>		<b>XGT 40V<sup>max</sup></b>			<b>connection cord</b>		<b>36V LITHIUM-ION</b>			<b>18V LITHIUM-ION</b>				<b>12V<sup>max</sup> LITHIUM-ION</b>
	UR012G	UR013G	UR006G	UR007G	UR003G	UR101C	UR201C	DUR369N	DUR369A	DUR364L	DUR192L	DUR193	DUR190	DUR194	UR100D
Handle	Bike	Bike	Bike	Loop	Loop	Bike	Loop	Loop	Bike	Loop	Loop	Loop	Bike	Loop	Loop
Nylon Head	480mm	480mm	430mm	430mm	350mm	430mm	430mm	430mm	430mm	350mm	300mm	260mm	300mm	280mm	260mm
Metal Blade	305mm	305mm	255mm	255mm	230mm	255mm	255mm	255mm	-	-	-	-	230mm	200mm	-
Plastic Blade	305mm	305mm	305mm	305mm	255mm	255mm	255mm	255mm	-	-	-	-	255mm	230mm	230mm



UR101C / UR201C

36V | 

Cordless Grass Trimmer powered by Portable Power Pack Units



- Used with PDC01 or PDC1200 power source kit
- Excellent tool in continuous work
- High power 1 kW equivalent to petrol tool
- Electronic 3-Speed control

**Reverse switch**  
for clearing entangled weeds and grass from cutting head

**BL Motor**  
Rear end mounted brushless motor makes the tool balance similar to engine grass trimmers

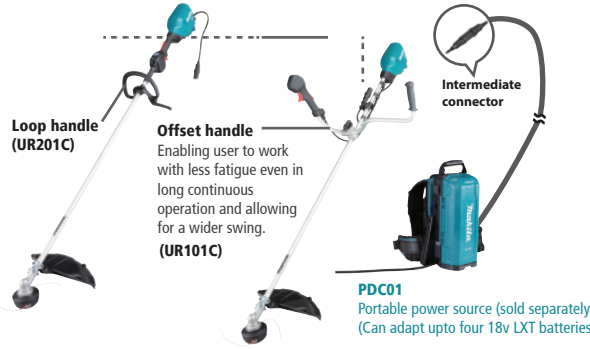

**Runtime\***  
Nylon cutting head (430mm)

Low	Mid	Hi
58	40	26
min		
PDC01 (BL1860B x4)		

\*No load continuous run time (approx)

Specifications:-

<b>Cutting Width</b>	<b>UR101C</b> Metal Blade: 255 mm Nylon Cutting Head: 430 mm Plastic Blade: 255 mm
<b>No Load Speed (RPM)</b>	<b>UR101C</b> Metal Blade (3 / 2 / 1): 0 - 7,000 / 0 - 5,500 / 0 - 4,600 Nylon Cutting Head (3 / 2 / 1): 0 - 5,500 / 0 - 5,000 / 0 - 4,600 Plastic Blade (305 mm) (3 / 2 / 1): 0 - 7,000 / 0 - 5,500 / 0 - 4,600 Plastic Blade (255 mm) (3 / 2 / 1): 0 - 5,500 / 0 - 5,000 / 0 - 4,600 M10 x 1.25 LH Left / Right: 2.5 / 2.5 m/s <sup>2</sup> or less
<b>Spindle Size</b>	M10 x 1.25 LH
<b>Vibration Level</b>	Left / Right: 2.5 / 2.5 m/s <sup>2</sup> or less
<b>Dimensions (L x W x H)</b>	1,760x628x550 mm
<b>Net weight</b>	5.2 kg

<b>Cutting Width</b>	<b>UR201C</b> Metal Blade: 255 mm Nylon Cutting Head: 430 mm Plastic Blade: 255 mm
<b>No Load Speed (RPM)</b>	<b>UR201C</b> Metal Blade (3 / 2 / 1): 0 - 7,000 / 0 - 5,500 / 0 - 4,600 Nylon Cutting Head (3 / 2 / 1): 0 - 5,500 / 0 - 5,000 / 0 - 4,600 Plastic Blade (305 mm) (3 / 2 / 1): 0 - 7,000 / 0 - 5,500 / 0 - 4,600 Plastic Blade (255 mm) (3 / 2 / 1): 0 - 5,500 / 0 - 5,000 / 0 - 4,600 M10 x 1.25 LH Left / Right: 2.5 / 2.5 m/s <sup>2</sup> or less
<b>Spindle Size</b>	M10 x 1.25 LH
<b>Vibration Level</b>	Left / Right: 2.5 / 2.5 m/s <sup>2</sup> or less
<b>Dimensions (L x W x H)</b>	1,795x400x269 mm
<b>Net weight</b>	4.7 kg

**Standard Equipment:** Safety Goggles, Hex Wrench

**AVAILABLE VARIANTS**  
"Z" VARIANT

**AVAILABLE VARIANTS**  
"Z" VARIANT

**UR101C Z**  
TOOL ONLY  
(DOES NOT INCLUDE PORTABLE POWER PACK)

**UR201C Z**  
TOOL ONLY  
(DOES NOT INCLUDE PORTABLE POWER PACK)

UR012G 480mm

80V MAX | 

Cordless Grass Trimmer

As powerful as 40cc petrol grass trimmer  
Ideal for heavy-duty operation due to high output power

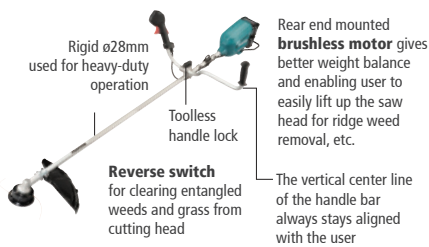

<b>Max Output</b>	2.0 kW
<b>Cutting Width</b>	Metal Blade: 305 mm Chisel Blade: 225 mm Nylon Cutting Head: 480 mm Shredder Blade: 270 mm Plastic Blade: 305 mm
<b>No Load Speed (RPM)</b>	Metal Blade (3 / 2 / 1): 0 - 6,800 / 0 - 5,000 / 0 - 3,500 Nylon Cutting Head (3 / 2 / 1): 0 - 5,000 / 0 - 4,200 / 0 - 3,500
<b>Spindle Size</b>	M10 x 1.25 LH
<b>Dimensions (L x W x H)</b>	1,829 x 680 x 590 mm
<b>Net weight</b>	6.6 kg (without battery)

AVAILABLE VARIANTS

"Z" VARIANT

**UR012G Z**  
TOOL ONLY  
(DOES NOT INCLUDE BATTERY / CHARGER)

UR013G 450mm

40V MAX | 

Cordless Grass Trimmer

As powerful as 35cc petrol grass trimmer  
Ideal for heavy-duty operation due to high output power

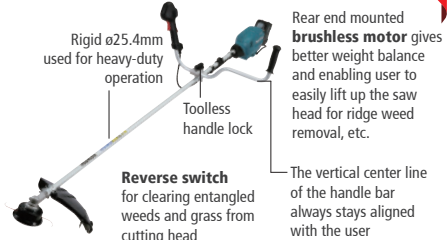

<b>Max Output</b>	1.5 kW
<b>Cutting Width</b>	Metal blade: 255 mm Chisel blade: 225 mm, Nylon Cutting Head: 450 mm, Shredder blade: 270 mm, Plastic Blade: 305 mm
<b>No Load Speed (RPM)</b>	Metal blade: 3,500-6,700, Nylon Cutting Head: 3,500-5,000
<b>Spindle Size</b>	M10 x 1.25 LH
<b>Dimensions (L x W x H)</b>	1,863 x 690 x 546 mm (Tool only)
<b>Net weight</b>	5.3 kg (without battery)

AVAILABLE VARIANTS

"Z" VARIANT

**UR013G Z**  
TOOL ONLY  
(DOES NOT INCLUDE BATTERY / CHARGER)

DRILLING / FIXING

CONCRETE DRILLING / DEMOLITION

MIXING / STIRRING

CUTTING (CONCRETE / METAL)

GRINDING

SANDING / POLISHING

SAWING

MULTI-TOOL

ROUTERS / PLANERS

NAILERS / STAPLERS

HEAT GUN / LASER

CLEANING

OPE

JOB SITE TOOLS

SPECIALTY TOOLS

HAND TOOLS / COMBINATION SET

TOOL HOLDERS AND POUCHES / MAKPAC SYSTEM

DRILLING / FIXING
CONCRETE DRILLING / DEMOLITION
MIXING / STIRRING
CUTTING (CONCRETE / METAL)
GRINDING
SANDING / POLISHING
SAWING
MULTI-TOOL

### UR007G - 430 mm 40V MAX | XGT

#### Cordless Grass Trimmer (Loop handle)

**As powerful as 30cc petrol grass trimmer**

Rear end mounted **brushless motor** gives better weight balance and enabling user to easily lift up the saw head for ridge weed removal, etc.

**Reverse switch** for clearing entangled weeds and grass from cutting head



**ADAPT TO**

- METAL BLADE
- NYLON CUTTING HEAD
- PLASTIC BLADE

**Standard Equipment:** Safety Goggles, Accessory Bag, Hex Wrench, Box Driver, Shoulder Belt

AVAILABLE VARIANTS	
<b>4.0Ah</b>	<b>"Z" VARIANT</b>
<b>UR007G M1</b> - 1PC OF BL4040 XGT BATTERY - FAST CHARGER DC40RA	<b>UR007G Z</b> TOOL ONLY (DOES NOT INCLUDE BATTERY / CHARGER)

### UR006G - 430mm 40V MAX | XGT

#### Cordless Grass Trimmer (Bike handle)

**As powerful as 30cc petrol grass trimmer**

The vertical center line of the handle bar always stays aligned with the user

Toolless handle lock

**Reverse switch** for clearing entangled weeds and grass from cutting head

Rear end mounted **brushless motor** gives better weight balance and enabling user to easily lift up the saw head for ridge weed removal, etc.

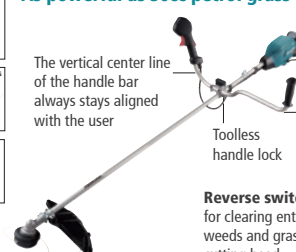

**ADAPT TO**

- METAL BLADE
- NYLON CUTTING HEAD
- PLASTIC BLADE

**Standard Equipment:** Safety Goggles, Accessory Bag, Hex Wrench, Box Driver, Shoulder Belt

AVAILABLE VARIANTS	
<b>4.0Ah</b>	<b>"Z" VARIANT</b>
<b>UR006G M1</b> - 1PC OF BL4040 XGT BATTERY - FAST CHARGER DC40RA	<b>UR006G Z</b> TOOL ONLY (DOES NOT INCLUDE BATTERY / CHARGER)

ROUTERS / PLANERS
NAILERS / STAPLERS
HEAT GUN / LASER
CLEANING
OPE
JOB SITE TOOLS
SPECIALTY TOOLS
HAND TOOLS / COMBINATION SET
TOOL HOLDERS AND POUCHES / MAKPAC SYSTEM

### UR003G - 350 mm 40V MAX | XGT

#### Cordless Grass Trimmer

**As powerful as 25cc petrol grass trimmer**

**Outer Rotor Brushless motor** provides high operating efficiency.

Direct drive system for more power, more speed and longer run time

**Reverse switch** for clearing entangled weeds and grass from cutting head



**ADAPT TO**

- METAL BLADE
- NYLON CUTTING HEAD
- PLASTIC BLADE

**Standard Equipment:** Safety Goggles, Accessory Bag, Hex Wrench, Box Driver, Shoulder Belt

AVAILABLE VARIANTS	
<b>"Z" VARIANT</b>	
<b>UR003G Z</b> TOOL ONLY (DOES NOT INCLUDE BATTERY / CHARGER)	

### DUR369N 18Vx2 LXT

#### Cordless Grass Trimmer

**Loop handle**

**BL Motor**  
Rear end mounted brushless motor makes the tool balance similar to engine grass trimmers

**Reverse switch** for clearing entangled weeds and grass from cutting head



**ADAPT TO**

- NYLON CUTTING HEAD
- PLASTIC BLADE

**Standard Equipment:** Safety Goggles, Hex Wrench

AVAILABLE VARIANTS	
<b>"Z" VARIANT</b>	
<b>DUR369N Z</b> TOOL ONLY (DOES NOT INCLUDE BATTERY / CHARGER)	

**DUR369A** 18Vx2 **LXT**

**Cordless Grass Trimmer**

**ADAPT TO**

- METAL BLADE
- NYLON CUTTING HEAD
- PLASTIC BLADE



**Offset handle**  
Enabling user to work with less fatigue even in long continuous operation and allowing for a wider swing.

**BL Motor**  
Rear end mounted brushless motor makes the tool balance similar to engine grass trimmers

**Reverse switch**  
for clearing entangled weeds and grass from cutting head

**Reverse switch** for clearing entangled weeds and grass from cutting head

**Reverse switch** for clearing entangled weeds and grass from cutting head

<b>Cutting Width</b>	Metal Blade: 255 mm Nylon Cutting Head: 430 mm Plastic Blade: 305 mm
<b>No Load Speed (RPM)</b>	Metal Blade (3 / 2 / 1): 0 - 7,000 / 0 - 5,500 / 0 - 4,600 Nylon Cutting Head (3 / 2 / 1): 0 - 5,500 / 0 - 5,000 / 0 - 4,600 Plastic Blade (305 mm) (3 / 2 / 1): 0 - 7,000 / 0 - 5,500 / 0 - 4,600 Plastic Blade (255 mm) (3 / 2 / 1): 0 - 5,500 / 0 - 5,000 / 0 - 4,600
<b>Spindle Size</b>	M10 x 1.25 LH
<b>Vibration Level</b>	Left / Right: 2.5 / 2.5 m/s <sup>2</sup> or less
<b>Dimensions (L x W x H)</b>	1,846x628x530 mm
<b>Net weight</b>	6.3 kg

**Standard Equipment:** Safety Goggles, Hex Wrench

**AVAILABLE VARIANTS**

**"Z" VARIANT**

**DUR369A Z**  
TOOL ONLY  
(DOES NOT INCLUDE BATTERY / CHARGER)

**DUR364L** 18Vx2 **LXT**

**Cordless Grass Trimmer**

**ADAPT TO**

- NYLON CUTTING HEAD
- PLASTIC BLADE



**Loop handle**

**Reverse switch**  
for clearing entangled weeds and grass from cutting head

**Direct drive system**  
for more power, more speed and longer run time

**BL Motor**  
Outer Rotor BL Motor provides high operating efficiency

**Reverse switch** for clearing entangled weeds and grass from cutting head

<b>Cutting Width</b>	Trimmer Head: 350 mm
<b>No Load Speed (RPM)</b>	High / Low: 6,500 / 5,000
<b>Spindle Size</b>	M8 x 1.25 RH
<b>Vibration Level</b>	Front / Rear: 2.5 / 2.5 m/s <sup>2</sup> or less
<b>Dimensions (L x W x H)</b>	1,754x310x229 mm
<b>Net weight</b>	4.4 kg

**Standard Equipment:** Safety Goggles, Hex Wrench

**AVAILABLE VARIANTS**

**"Z" VARIANT**

**DUR364L Z**  
TOOL ONLY  
(DOES NOT INCLUDE BATTERY / CHARGER)

**DUR192L** 18V | **LXT**

**Cordless Grass Trimmer**

**ADAPT TO**

- NYLON CUTTING HEAD



**Powerful, Lightweight and Ergonomical brushless motor**

- Cost competitive model with increased output power, the switch and protector are simplified by specializing this trimmer for use with nylon cutting head only
- Split type shaft allows for smaller package, which is suitable for online delivery or space saving storage and display at retailer
- Better maneuverability through lightweight and more powerful cutting performance than DUR190L series

<b>Cutting Width</b>	300 mm
<b>No Load Speed (RPM)</b>	High / Low: 0 - 4,500 / 0 - 6,000
<b>Spindle Size</b>	M10 x 1.25 LH
<b>Sound Pressure Level</b>	74.8 dB(A)
<b>Sound Power Level</b>	87.8 dB(A)
<b>Vibration Level</b>	Front / Rear: 2.5 / 2.5 m/s <sup>2</sup> or less
<b>Dimensions (L x W x H)</b>	1,670 x 186 x 246 mm
<b>Net weight</b>	3.0 kg

**Standard Equipment:** Band Assembly, Hex Wrench

**AVAILABLE VARIANTS**

<b>5.0Ah</b>	<b>"Z" VARIANT</b>
<b>DUR192L RT</b> INCLUDES 1 BATTERY / 1 CHARGER (DOES NOT INCLUDE CARRY CASE)	<b>DUR192L Z</b> TOOL ONLY (DOES NOT INCLUDE BATTERY / CHARGER OR CARRY CASE)

**DUR194** 18V | **LXT**

**Cordless Grass Trimmer**

**ADAPT TO**

- STANDARD METAL BLADE
- PLASTIC BLADE
- NYLON CUTTING HEAD



**Lightweight 2-Speed Grass Trimmer, Loop Handle**

- Speed Change Switch for easy high/low speed selection
- Toolless shaft lock for plastic blade change
- Soft grip of ergonomic design
- Non-Adjustable Loop Handle with Barrier

<b>Cutting Width</b>	Metal Blade: 200 mm Nylon Cutting Head Head: 280 mm Plastic Blade: 230 mm
<b>No Load Speed (RPM)</b>	High / Low: 6,000 / 4,500
<b>Spindle Size</b>	M10 x 1.25 LH
<b>Sound Pressure Level</b>	Metal Blade: 73.5 dB(A)
<b>Sound Power Level</b>	Metal Blade: 88.6 dB(A)
<b>Vibration Level</b>	Front / Rear: 2.5 / 2.5 m/s <sup>2</sup> or less
<b>Dimensions (L x W x H)</b>	1,630 x 288 x 236 mm
<b>Net weight</b>	2.2 kg (without battery)

**Standard Equipment:** Shoulder Belt, Hex Wrench, Box Driver, Accessory Bag

**AVAILABLE VARIANTS**

<b>5.0Ah</b>	<b>"Z" VARIANT</b>
<b>DUR194 RF</b> INCLUDES 1 BATTERY / 1 CHARGER (DOES NOT INCLUDE CARRY CASE)	<b>DUR194 Z</b> TOOL ONLY (DOES NOT INCLUDE BATTERY / CHARGER OR CARRY CASE)

- DRILLING / FIXING
- CONCRETE DRILLING / DEMOLITION
- MIXING / STIRRING
- CUTTING (CONCRETE / METAL)
- GRINDING
- SANDING / POLISHING
- SAWING
- MULTI-TOOL
- ROUTERS / PLANERS
- NAILERS / STAPLERS
- HEAT GUN / LASER
- CLEANING
- OPE
- JOB SITE TOOLS
- SPECIALTY TOOLS
- HAND TOOLS / COMBINATION SET
- TOOL HOLDERS AND POUCHES / MAKPAC SYSTEM

DRILLING / FIXING
CONCRETE DRILLING / DEMOLITION
MIXING / STIRRING
CUTTING (CONCRETE / METAL)
GRINDING
SANDING / POLISHING
SAWING
MULTI-TOOL
ROUTERS / PLANERS
NAILERS / STAPLERS
HEAT GUN / LASER
CLEANING
OPE
JOBSITE TOOLS
SPECIALTY TOOLS
HAND TOOLS / COMBINATION SET
TOOL HOLDERS AND POUCHES / MAKPAC SYSTEM

**DUR190**
18V | **LXT**

### Cordless Grass Trimmer

**ADAPT TO**

METAL BLADE

PLASTIC BLADE

NYLON CUTTING HEAD

**18V LXT BL ADT Cordless Grass Trimmer, Lightweight design with excellent tool balance for easy handling during operation**

- Multifunctional control panel for power on-off / variable speed control / reversing blade rotation
- Nylon cutting head rotating clockwise prevents grass clippings from flying towards user's side
- Anti-weed winding guard - The guard integrated with receive washer prevents weed winding.
- Toolless shaft lock for easy blade change

<b>Cutting Width</b>	Trimmer Head: 300 mm Metal Blade: 230 mm Plastic Blade: 255 mm
<b>Max Run Time (min)</b>	66 / 89 / 210 (with nylon cutting head) ( BL1860B)
<b>No Load Speed (RPM)</b>	3,500 - 6,000
<b>Spindle Size</b>	M10 x 1.25 LH
<b>Dimensions (L x W x H)</b>	1,836x610x473 mm
<b>Net weight</b>	3.4 kg

AVAILABLE VARIANTS

5.0Ah	3.0Ah	"Z" VARIANT
<b>DUR190 RT</b> <small>INCLUDES 1 BATTERY / 1 CHARGER</small>	-	<b>DUR190 Z</b> <small>TOOL ONLY (DOES NOT INCLUDE BATTERY / CHARGER)</small>

**DUR193**
18V | **LXT**

### Cordless Grass Trimmer

**ADAPT TO**

NYLON CUTTING HEAD

**Lightweight for reduced operator fatigue**

- Telescopic shaft pipe adjustable in length from 1,248mm to 1,436mm.
- Easy-to-operate front grip adjustable to a desired height by changing the angle and position
- Angle adjustment of motor head : The cutting angle can be adjusted in 5 steps
- Edger function: also suitable for cutting the grass growing along the bricks or blocks.

<b>Cutting Width</b>	Nylon Cutting Head: 260 mm
<b>No Load Speed (RPM)</b>	7,800
<b>Max Run Time (min)</b>	w/ BL1830B: 45
<b>Sound Pressure Level</b>	73.2 dB(A)
<b>Sound Power Level</b>	83.1 dB(A)
<b>Vibration Level</b>	Left / Right: 2.5 / 2.5 m/s <sup>2</sup> or less
<b>Dimensions (L x W x H)</b>	1,248 - 1,436 x 265 x 358 mm
<b>Net weight</b>	1.9 kg (without battery)

**Standard Equipment:** Shoulder Belt

AVAILABLE VARIANTS

5.0Ah	3.0Ah	"Z" VARIANT
<b>DUR193 RF</b> <small>INCLUDES 1 BATTERY / 1 CHARGER (DOES NOT INCLUDE CARRY CASE)</small>	-	<b>DUR193 Z</b> <small>TOOL ONLY (DOES NOT INCLUDE BATTERY / CHARGER OR CARRY CASE)</small>

**DUR189**
18V | **LXT**

### Cordless Grass Trimmer

**ADAPT TO**

PLASTIC BLADE

NYLON CUTTING HEAD

**18V LXT BL ADT Cordless Grass Trimmer, Short Telescopic Pipe, Loop Handle (3 Speed Control)**

- Comfortable short telescopic pipe provides easy handling in tight spaces
- Multifunctional control panel for power on-off / variable speed control / reversing blade rotation
- Nylon cutting head rotating clockwise prevents grass clippings from flying towards user's side

<b>Cutting Width</b>	Trimmer Head: 300 mm
<b>No Load Speed (RPM)</b>	High / Medium / Low / ADT Mode: 6,000 / 5,000 / 4,000 / 4,000 - 6,000
<b>Spindle Size</b>	M8 x 1.25 RH
<b>Vibration Level</b>	Front / Rear: 2.1 / 1.6 or less
<b>Dimensions (L x W x H)</b>	1,518-1,618x258x369 mm
<b>Max Run Time (min)</b>	with BL1850B: 139
<b>Net weight</b>	3.4 kg

**Standard Equipment:** Safety Goggles, Hex Wrench

AVAILABLE VARIANTS

5.0Ah	3.0Ah	"Z" VARIANT
-	<b>DUR189 RFE</b> <small>INCLUDES 2 BATTERIES / 1 CHARGER</small>	<b>DUR189 Z</b> <small>TOOL ONLY (DOES NOT INCLUDE BATTERY / CHARGER)</small>

**UR100D**
12V MAX | **CXT**

### Cordless Grass Trimmer

**ADAPT TO**

PLASTIC BLADE

NYLON CUTTING HEAD

**12V max CXT Li-Ion Cordless Grass Trimmer**

- Well balanced design with fully adjustable features to suit any operator
- Delivers 10,000 / 9,000 RPM for faster cutting
- Compact size is ideal for trimming and precise edging

<b>Cutting Width</b>	Nylon Cutting Head: 260 mm
<b>No Load Speed (RPM)</b>	Nylon Cutting Head: 9,000
<b>Spindle Size</b>	M8 x 1.25 RH
<b>Vibration Level</b>	-
<b>Dimensions (L x W x H)</b>	835 - 1,185x267x210 - 315 mm
<b>Max Run Time (min)</b>	With BL1041B: 38
<b>Net weight</b>	2.3 kg

**Standard Equipment:** Safety Goggles, Hex Wrench

AVAILABLE VARIANTS

4.0Ah	2.0Ah	"Z" VARIANT
<b>UR100D WME</b> <small>INCLUDES 2 BATTERIES / 1 CHARGER</small>	-	<b>UR100D Z</b> <small>TOOL ONLY (DOES NOT INCLUDE BATTERY / CHARGER)</small>

**RST250** 24.5mL

**Petrol String Trimmer**



**Light weight and handy string trimmer.**

- Automatic / bump line feed trimmer head.
- Low noise and vibration.
- Solid state ignition for easy starting.
- Carburetor : Diaphragm-type, Ignition system : Solid state ignition.



<b>Displacement</b>	24.5 mL
<b>Power rating</b>	0.95KW / 1.3PS
<b>Fuel tank</b>	0.5L
<b>Fuel mixture</b>	25 : 1
<b>Dimensions</b>	1,490mm x 300mm x 485mm
<b>Net weight</b>	4.2kg (9.2lbs)

**Standard Equipment:** Tool kit.

**EM2650UH** 25.4mL-4stroke

**Petrol Brush Cutter**



**Maneuverable pole and handle.**

- Ergonomically designed rubberized soft grip provides more control and comfort.
- Universal guard for both saw blade and Nylon cutter.
- Light weight.
- No choke at starting engine.
- Good oil maintenance feature.



<b>Displacement</b>	25.4mL
<b>Engine power</b>	0.77kW / 1.1PS
<b>Fuel tank</b>	0.6L
<b>Spindle size</b>	M10 X 1.25LH
<b>Dimensions</b>	1,765 x 620 x 474mm
<b>(L x W x H)</b>	(69-1/2" x 24-3/8" x 18-2/3")
<b>Net weight</b>	5.5kg (12.14lbs)

**Standard Equipment:** Socket Wrench, Hex Wrenches

**EM4350RH** 43.0mL 4-stroke (Multi-position)

**Petrol Backpack Brush cutter**



**43.0ml 4-stroke backpack brushcutter for real professionals**

- The flexible shaft between engine and shaft allowing efficiently work on slops undulating ground or in narrow space.
- Professional-user type for superior maneuverability for heavy-duty applications in forestry and construction site area.
- Able to start/stop engine while carrying machine.
- Less recoil pulling power by mechanical decompression.
- Low vibration.



<b>Displacement</b>	43.0mL
<b>Engine power</b>	1.5kW / 2.1PS
<b>Fuel tank</b>	0.8L
<b>Spindle size</b>	M10 x 1.25LH
<b>Sound pressure level</b>	93dB(A)
<b>Sound power level</b>	111dB(A)
<b>Vibration level Front handle</b>	3.4m/s <sup>2</sup>
<b>Vibration level Rear handle</b>	2.4m/s <sup>2</sup>
<b>Dimensions (L x W x H)</b>	358x280x587mm (14-1/8" x 11" x 23-1/8")
<b>Net weight</b>	12.0kg (26.6lbs)

**Standard Equipment:** Tool set

**EE2650H** 25.4mL 4-stroke (Multi-position)

**Petrol Edger**



**Equipped with environment-friendly and cost-saving 25.4cc 4-stroke engine.**

- Multi-position engine lubrication system.
- Straight shaft (solid shaft).
- Plate on gear housing for protection against contact to concrete etc.



<b>Displacement</b>	25.4mL
<b>Engine power</b>	0.77kW / 1.1PS
<b>Fuel tank</b>	0.6L
<b>Sound pressure level</b>	88.6dB(A)
<b>Sound power level</b>	98.4dB(A)
<b>Vibration level Front handle</b>	3.7m/s <sup>2</sup>
<b>Vibration level Rear handle</b>	8.8m/s <sup>2</sup>
<b>Dimensions (L x W x H)</b>	1,773x242x315mm (69-3/4" x 9-1/2" x 12-3/8")
<b>Net weight</b>	6.6kg (14.6lbs)

**Standard Equipment:** Socket wrench, Hex wrench

DRILLING / FIXING

CONCRETE DRILLING / DEMOLITION

MIXING / STIRRING

CUTTING (CONCRETE / METAL)

GRINDING

SANDING / POLISHING

SAWING

MULTI-TOOL

ROUTERS / PLANERS

NAILERS / STAPLERS

HEAT GUN / LASER

CLEANING

OPE

JOBSITE TOOLS

SPECIALTY TOOLS

HAND TOOLS / COMBINATION SET

TOOL HOLDERS AND POUCHES / MAKPAC SYSTEM



# Lawn Mowers

MODEL #	VOLTS	DECK	CUTTING CAPACITY (mm)	BATTERY SLOT	BL MOTOR	TYPE	MOWING AREA (VALUES ARE WITH PUSH TYPE)	DISCHARGE TYPE
LM004J	64V MAX	Steel	534	1 Slot (parallel)	✓	Self Propelled	3,800 m <sup>2</sup> (WITH BL64100 / 10.Ah)	Rear   Side
LM002J	64V MAX	Plastic	534		✓	-	1,600 m <sup>2</sup> (WITH BL6440 / 4.0.Ah)	Rear
LM001J	64V MAX	Plastic	480		✓	-	1,400 m <sup>2</sup>	Rear
LM002G	40V MAX	Steel	534	2 Slot (parallel)	✓	Self Propelled	3,400 m <sup>2</sup> (WITH BL4080F x2 / 8.0.Ah)	Rear   Side
LM001C	Connection Cord	Steel	534	-	✓	Self Propelled	6,900 m <sup>2</sup> (WITH PDC1200)	Side
DLM533	18V X 2LXT	Aluminium	534	4 Slot (parallel)	✓	Self Propelled	2,300 m <sup>2</sup> (WITH BL1860B x4 / 6.0.Ah)	Rear
DLM532	18V X 2LXT	Steel	534		✓	Self Propelled	2,300 m <sup>2</sup> (WITH BL1860B x4 / 6.0.Ah)	Side
DLM531	18V X 2LXT	Steel	534		✓	-	2,300 m <sup>2</sup> (WITH BL1860B x4 / 6.0.Ah)	Side
DLM539	18V X 2LXT	Plastic	534	2 Slot	-	Self Propelled	800 m <sup>2</sup> (WITH BL1860B x2 / 6.0.Ah)	Rear
DLM538	18V X 2LXT	Plastic	534		-	-	800 m <sup>2</sup> (WITH BL1860B x2 / 6.0.Ah)	Rear
DLM481	18V X 2LXT	Plastic	480		-	Self Propelled	800 m <sup>2</sup> (WITH BL1860B x2 / 6.0.Ah)	Rear
DLM480	18V X 2LXT	Plastic	480		-	-	800 m <sup>2</sup> (WITH BL1860B x2 / 6.0.Ah)	Rear
DLM460	18V X 2LXT	Steel	460	2 Slot	✓	-	800 m <sup>2</sup> (WITH BL1860B x2 / 6.0.Ah)	-
DLM431	18V X 2LXT	Plastic	430		-	-	475 m <sup>2</sup> (WITH BL1850B x2 / 5.0.Ah)	-
DLM382	18V X 2LXT	Plastic	382		-	-	560 m <sup>2</sup> (WITH BL1860B x2 / 6.0.Ah)	-
DLM330	18V LXT	Plastic	330	1 Slot	-	-	450 m <sup>2</sup> (WITH BL1860B x1 / 6.0.Ah)	-

# 64V Li-ion max

The 64V Max range from Makita is a high voltage lithium-ion battery platform which is powered exclusively by 64V max lithium ion battery

Please note that 64V max Battery is exclusively designed for 64v max range of tools and it is not interchangeable with any other battery platform tools.



**DC64WA**  
64V max lithium-ion charger  
(Developed specially for charging 64Vmax battery)

64V max  
Lithium-ion battery

<b>BL64100</b> 10.0Ah	<b>BL6440</b> 4.0Ah
--------------------------	------------------------

300 min CHARGING TIME	120 min CHARGING TIME
--------------------------	--------------------------

DRILLING / FIXING

CONCRETE DRILLING / DEMOLITION

MIXING / STIRRING

CUTTING (CONCRETE / METAL)

GRINDING

SANDING / POLISHING

SAWING

MULTI-TOOL

ROUTERS / PLANERS

NAILERS / STAPLERS

HEAT GUN / LASER

CLEANING

OPE

JOBSITE TOOLS

SPECIALTY TOOLS

HAND TOOLS / COMBINATION SET

TOOL HOLDERS AND POUCHES / MAKPAC SYSTEM

## LM004J - 530mm 64V MAX

### Cordless Lawn Mower

Steel Deck | Self Propelled | Rear & Side Discharge



### 530mm High power Cordless Lawnmower, Powered by 64Vmax Li-Ion battery

- Lightweight design with a plastic cutting deck for increased maneuverability
- 3 in 1 (Cutting, Collecting, Mulching)
- 3 cutting modes (Normal/ Soft no-load/ Noise reduction)
- Foldable handle for quick and compact storage
- Grass box with grass level indicator
- Single-lever cutting height adjustment
- Child lock key
- 2-speed mode
- IPX4 : water resistant

Mowing area



Runtime  
**66 min**



Cutting width	534 mm	with BL64100 (push drive)
Cutting height adjustment	Adjustment range: 20 - 100 mm, Stage: 10	
No load speed (RPM)	Normal mode: 2,800, Soft no-load mode: 2,300 - 2,800	
	Noise reduction mode: 2,300	
Grass box	Capacity: 70 L	
Vibration level	2.5 m/s <sup>2</sup> or less	
Measured sound power level	91 dB(A)	
Sound pressure level	82 dB(A)	
Dimensions (L x W x H)	1,740 - 1,810 x 595 x 970 - 1,080 mm	
Net weight	31.5kg (without battery)	

**Standard Equipment:** Blade, Mulching plug, Socket wrench, Rod, Discharge chute,

10.0Ah

"Z" VARIANT

**LM004J B1**  
1PC BATTERY + 1 CHARGER

**LM004J Z**  
TOOL ONLY  
(DOES NOT INCLUDE BATTERY / CHARGER)

## LM002J - 530mm 64V MAX

### Cordless Lawn Mower

Plastic Deck | Push Type | Rear Discharge



### 530mm High power Cordless Lawnmower, Powered by 64Vmax Li-Ion battery

- Lightweight design with a plastic cutting deck for increased maneuverability
- 3 in 1 (Cutting, Collecting, Mulching)
- 3 cutting modes (Normal/ Soft no-load/ Noise reduction)
- Foldable handle for quick and compact storage
- Grass box with grass level indicator
- Single-lever cutting height adjustment
- Child lock key
- 2-speed mode
- IPX4 : water resistant

Mowing area

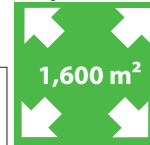

Runtime  
**39 min**



Cutting Width	534 mm	with BL6440 (push drive)
Cutting Height	20 - 100 mm	
Grass Box capacity	70 L	
No Load Speed (RPM)	Standard Mode: 2,800	
	Soft No-Load Mode: 2,300 - 2,800	
	Low Noise Mode: 2,300	
Sound Pressure / Power Level	82.1 dB(A) / 91.6 dB(A)	
Vibration Level	2.5 m/s <sup>2</sup> or less	
Dimensions (L x W x H)	1,710 - 1,800 x 585 x 985 - 1,115 mm	
Net weight	25.4 kg (without battery)	

**Standard Equipment:** Blade, Mulching Plug, Box Wrench, Rod

AVAILABLE VARIANTS

4.0Ah

**LM002J M1**  
1PC BATTERY + 1 CHARGER

- DRILLING / FIXING
- CONCRETE DRILLING / DEMOLITION
- MIXING / STIRRING
- CUTTING (CONCRETE / METAL)
- GRINDING
- SANDING / POLISHING
- SAWING
- MULTI-TOOL
- ROUTERS / PLANERS

**LM001J** - 480mm
**64V MAX**

**64V MAX - Cordless Lawn Mower**

**Plastic Deck | Push Type | Rear Discharge**

**480mm High power Cordless Lawnmower, Powered by 64Vmax Li-Ion battery**

- Lightweight design with a plastic cutting deck for increased maneuverability
- 3 in 1 (Cutting, Collecting, Mulching)
- 3 cutting modes (Normal/ Soft no-load/ Noise reduction)
- Foldable handle for quick and compact storage
- Grass box with grass level indicator
- Single-lever cutting height adjustment
- Child lock key | 2-speed mode | IPX4 : water resistant

Runtime  
34 min

Mowing area  
1,400 m<sup>2</sup>

with BL6440 x 1 (push drive)

<b>Cutting Width</b>	480 mm
<b>Cutting Height</b>	20 - 100 mm
<b>Grass Box capacity</b>	62L
<b>No Load Speed (RPM)</b>	Standard Mode: 3,200 Soft No-Load Mode: 2,500 - 3,200 Low Noise Mode: 2,500
<b>Sound Pressure / Power Level</b>	84.9 dB(A) / 92.5 dB(A)
<b>Vibration Level</b>	2.5 m/s <sup>2</sup> or less
<b>Dimensions (L x W x H)</b>	1,610 - 1,690 x 530 x 930 - 1,050 mm
<b>Net weight</b>	24.4 kg (without battery)

**Standard Equipment:** Blade, Mulching Plug, Box Wrench, Rod

**4.0Ah**

**LM001J M1**  
 1PC BATTERY + 1 CHARGER



- NAILERS / STAPLERS
- HEAT GUN / LASER
- CLEANING
- OPE
- JOBSITE TOOLS
- SPECIALTY TOOLS
- HAND TOOLS / COMBINATION SET
- TOOL HOLDERS AND POUCHES / MAKPAC SYSTEM

**LM001C** - 534mm
**36V**

**Cordless Lawn Mower Powered by Portable Power Pack Units**

**Steel deck | Self-propelled type | Side Discharge**

**Provides longer runtime to get through the largest jobs**  
**Achieved by connecting directly through power pack units**

- Mowing area Up to 5,100m<sup>2</sup> or over 1 acre worth of runtime with PDC1200 (self-propelled mode)
- 3 cutting modes to suit the working environment
- Self-propelled type with variable speed control allowing you to select the accurate speed between 2.5km/h to 5.0km/h
- Optimum blade design for less rotational speed reduction of the blade
- Cutting height is adjustable by one handle

**Works with Portable Power Pack Units PDC1200 or PDC01 (sold separately)**

Runtime  
150 min

Mowing area  
5,100 m<sup>2</sup>

with PDC1200 (push drive)

**PDC1200**  
 36V built-in battery



**PDC01**  
 4 x 18V LXT battery

**WG**  
 WET GUARD  
 Wet Guard / IPX4  
 High water-resistance allows to operate the machine even if it is wet with water  
**LM001C + PDC1200 only**

	with PDC1200	with PDC01
<b>Actual Mowing Area</b>	Self-Propelled: 5,100 m <sup>2</sup> push-drive: 6,900 m <sup>2</sup>	Self-Propelled: 1,700 m <sup>2</sup> push-drive: 2,300 m <sup>2</sup>
<b>Continuous Use (min.)</b>	Self-Propelled: 120 push-drive: 150	Self-Propelled: 40 push-drive: 50

\* the above values are calculated with 2-tooth blade



**LM002G - 534mm**

40V MAX | **XGT**

**Cordless Lawn Mower**

Aluminium Deck | Self Propelled | Rear Discharge | Side Discharge

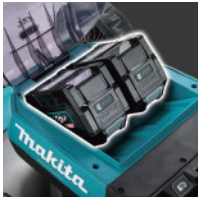

Powered by 40Vmax XGT Li-Ion battery (two in parallel or one)



**Automatic battery switching**  
If two batteries are installed and one battery in use has run out of power, the battery system automatically switches to the other one.

**Self-propelled type**  
with a speed range of 1.5-5.0km/h

- On/off switch lever for self-propelled function
- Quick acceleration (0.5s to full speed)
- The lowest speed has been reduced to enable the machine to turn in a small space.

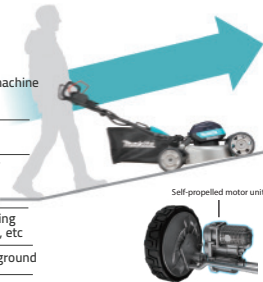

Approx speed range: km/h	Main application
1.5-2.5	Mowing a small area around tree, near obstacle, etc where lawn mower is required to turn in a small space
2.5-4.0	Heavy-duty applications such as mowing on slope, cutting dense and long grass, etc
4.0-5.0	Light to medium duty mowing on flat ground

**As powerful as AC Lawn Mower**

- 3 in 1 (Cutting, Collecting, Mulching)
- Grass box with grass level indicator
- Single-lever cutting height adjustment
- Built-in ball bearing on axles for added durability
- Child lock key
- 2-speed mode



Mowing area  
**3,300 m<sup>2</sup>**

Runtime  
**76 min**  
with BL1880B x 2 (push drive)



<b>Cutting width</b>	53 mm (2 1/8")
<b>Cutting height adjustment</b>	Adjustment range: 20 - 100 mm Stage: 10
<b>No load speed (RPM)</b>	Normal / Soft no-load / Noise reduction mode: 2,800 / 2,300 - 2,800 / 2,300
<b>Grass box</b>	Capacity: 70 L
<b>Vibration Level</b>	2.5 m/s <sup>2</sup> or less
<b>Measured sound power level</b>	91 dB(A)
<b>Sound pressure level</b>	81 dB(A)
<b>Dimensions (L x W x H)</b>	During operation: 1,740 - 1,810 x 595 x 970 - 1,080 mm When stored (w/o Grass box): 580 x 595 x 930 mm
<b>Net weight</b>	34.7 kg

**Standard Equipment:** Blade, Mulching plug, Socket wrench, Rod,

AVAILABLE VARIANTS	
5.0Ah	"Z" VARIANT
<b>LM002G T2</b> - 2 x BATTERY - 1 x FAST CHARGER	<b>LM002G Z</b> TOOL ONLY (DOES NOT INCLUDE BATTERY / CHARGER)

**4 battery slots Lawn Mower for continuous operation**

Long continuous operation time achieved by parallely connecting two pairs of 18V LXT Li-Ion batteries connected in series

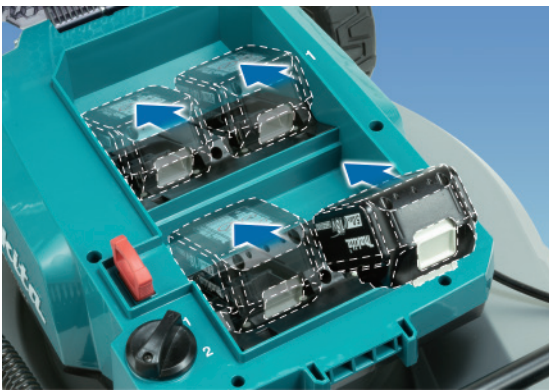

**Only for models DLM533, DLM532, DLM531**



**DLM533 - 534mm**

18Vx2 | **LXT**

**Cordless Lawn Mower with 4 battery slots**

Aluminium Deck | Self Propelled | Rear Discharge

4 battery slots



**Powered by two 18V LXT Batteries. Holds 4 batteries for twice the run time**

- 3 in 1 (Cutting, Collecting, Mulching)
- Grass box with grass level indicator
- Single-lever cutting height adjustment
- Built-in ball bearing on axles for added durability
- Child lock key and 2-speed mode
- IPX4 : water resistant

Mowing area  
**2,300 m<sup>2</sup>**

Runtime  
**54 min**  
with BL1860B x 4 (push drive)



<b>Cutting Width</b>	534 mm
<b>Cutting Height</b>	20 - 100 mm
<b>Deck Type</b>	Aluminium
<b>No. of stages</b>	10 stages
<b>No Load Speed (RPM)</b>	2,300 - 2,800
<b>Propelling speed</b>	2.5 - 5.0 km/h
<b>Dimensions (L x W x H)</b>	1,655-1,740x590x990-1,100 mm
<b>Net weight</b>	47.9 kg

**Standard Equipment:** Mulch Plug, Socket Wrench, Rod

AVAILABLE VARIANTS	
"Z" VARIANT	
<b>DLM533 Z</b> TOOL ONLY (DOES NOT INCLUDE BATTERY / CHARGER)	

DRILLING / FIXING

CONCRETE DRILLING / DEMOLITION

MIXING / STIRRING

CUTTING (CONCRETE / METAL)

GRINDING

SANDING / POLISHING

SAWING

MULTI-TOOL

ROUTERS / PLANERS

NAILERS / STAPLERS

HEAT GUN / LASER

CLEANING

OPE

JOB SITE TOOLS

SPECIALTY TOOLS

HAND TOOLS / COMBINATION SET



TOOL HOLDERS AND POUCHES / MAKPAC SYSTEM

- DRILLING / FIXING
- CONCRETE DRILLING / DEMOLITION
- MIXING / STIRRING
- CUTTING (CONCRETE / METAL)
- GRINDING
- SANDING / POLISHING
- SAWING
- MULTI-TOOL
- ROUTERS / PLANERS
- NAILERS / STAPLERS
- HEAT GUN / LASER
- CLEANING
- OPE
- JOBSITE TOOLS
- SPECIALTY TOOLS
- CARRY CASE / TOOL HOLDERS / POUCHES

**DLM532 - 534mm** 18Vx2 **LXT**

**Cordless Lawn Mower with 4 battery slots**

Steel Deck | Self Propelled | Side Discharge 4 battery slots

**Powered by two 18V LXT Batteries. Holds 4 batteries for twice the run time**

- Optimum blade design for less rotational speed reduction of the blade
- Enhanced rigidity of handle
- Grass box with grass level indicator
- Single-lever cutting height adjustment
- Built-in ball bearing on axles for added durability
- Child lock key
- 2-speed mode

Mowing area **2,300 m<sup>2</sup>**

Runtime **54 min** with BL1860B x 4 (push drive)

Cutting Width	534 mm
Cutting Height	20 - 100 mm
Deck Type	Steel
No. of stages	10 stages
No Load Speed (RPM)	2,300 - 2,800
Propelling speed	2.5 - 5.0 km/h
Dimensions (L x W x H)	1,630-1,715x590x990-1,095 mm
Net weight	42.9 kg

Standard Equipment: Mulch Plug, Side Discharge Mouth, Socket Wrench, Rod

AVAILABLE VARIANTS



**"Z" VARIANT**

**DLM532 Z**  
TOOL ONLY  
(DOES NOT INCLUDE BATTERY / CHARGER)

**DLM531 - 534mm** 18Vx2 **LXT**

**Cordless Lawn Mower with 4 battery slots**

Steel Deck | Push Type | Side Discharge 4 battery slots

**Powered by two 18V LXT Batteries. Holds 4 batteries for twice the run time**

- Optimum blade design for less rotational speed reduction of the blade
- Enhanced rigidity of handle
- Grass box with grass level indicator
- Single-lever cutting height adjustment
- Built-in ball bearing on axles for added durability
- Child lock key
- 2-speed mode

Mowing area **2,300 m<sup>2</sup>**

Runtime **54 min** with BL1860B x 4 (push drive)

Cutting Width	534 mm
Cutting Height	20 - 100 mm
Deck Type	Steel
No. of stages	10 stages
No Load Speed (RPM)	2,300 - 2,800
Propelling speed	2.5 - 5.0 km/h
Dimensions (L x W x H)	1,630-1,715x590x990-1,095 mm
Net weight	38.3 kg

Standard Equipment: Side Discharge, Socket wrench

AVAILABLE VARIANTS

**"Z" VARIANT**

**DLM531 Z**  
TOOL ONLY  
(DOES NOT INCLUDE BATTERY / CHARGER)

**DLM539 - 534mm** 18Vx2 **LXT**

**Cordless Lawn Mower**

Plastic Deck | Self Propelled | Rear Discharge



**Plastic Cutting Deck allows for lightweight design to increase maneuverability in turns, preparation, storage and more.**

- Multi-purpose 2-tooth blade for mowing and mulching
- Grass box with grass level indicator
- Single-lever cutting height adjustment
- Built-in ball bearing on axles for added durability
- Child lock key

Recommended mowing area **800 m<sup>2</sup>**

Runtime **25 min** with BL1860B x 2 (push drive)

Cutting Width	534 mm
Cutting Height	20 - 100 mm
Deck Type	Plastic
No. of stages	10 stages
No Load Speed (RPM)	3,800
Propelling speed	2.5 - 5.0 km/h
Dimensions (L x W x H)	1,810 - 1,870 x 580 x 920 - 1,040 mm
Net weight	29.1 kg

Standard Equipment: Mulch Plug, Socket Wrench, Rod

AVAILABLE VARIANTS

**5.0Ah** **"Z" VARIANT**

**DLM539 PT2**  
INCLUDES 2 BATTERIES / 1 TWO PORT CHARGER

**DLM539 Z**  
TOOL ONLY  
(DOES NOT INCLUDE BATTERY / CHARGER)

**DLM538 - 534mm** 18Vx2 **LXT**

**Cordless Lawn Mower**

Plastic Deck | Push Type | Rear Discharge



**Plastic Cutting Deck allows for lightweight design to increase maneuverability in turns, preparation, storage and more.**

- Multi-purpose 2-tooth blade for mowing and mulching
- Grass box with grass level indicator
- Single-lever cutting height adjustment
- Built-in ball bearing on axles for added durability
- Child lock key

Recommended mowing area **800 m<sup>2</sup>**

Runtime **25 min** with BL1860B x 2 (push drive)

Cutting Width	534 mm
Cutting Height	20 - 100 mm
Deck Type	Plastic
No. of stages	10 stages
No Load Speed (RPM)	3,800
Propelling speed	-
Dimensions (L x W x H)	1,810 - 1,870 x 580 x 920 - 1,040 mm
Net weight	26.7 kg

Standard Equipment: Mulch Plug, Socket Wrench, Rod

AVAILABLE VARIANTS

**5.0Ah** **"Z" VARIANT**

**DLM538 PT2**  
INCLUDES 2 BATTERIES / 1 TWO PORT CHARGER

**DLM538 Z**  
TOOL ONLY  
(DOES NOT INCLUDE BATTERY / CHARGER)

**DLM481 - 480mm** 18Vx2 **LXT**

**Cordless Lawn Mower**

Plastic Deck | Self Propelled | Rear Discharge



**Plastic Cutting Deck allows for lightweight design to increase maneuverability in turns, preparation, storage and more.**

- Multi-purpose 2-tooth blade for mowing and mulching
- Grass box with grass level indicator
- Single-lever cutting height adjustment
- Built-in ball bearing on axles for added durability
- Child lock key

Recommended mowing area **800 m<sup>2</sup>**

Runtime **28min**  
with BL1860B x 2 (push drive)

<b>Cutting Width</b>	480 mm
<b>Cutting Height</b>	20 - 100 mm
<b>Deck Type</b>	Plastic
<b>No. of stages</b>	10 stages
<b>No Load Speed (RPM)</b>	3,100
<b>Propelling speed</b>	2.5 - 5.0 km/h
<b>Dimensions (L x W x H)</b>	1,690 - 1,740 x 530 x 930 - 1,060 mm
<b>Net weight</b>	28 kg

**Standard Equipment:** Mulch Plug, Socket Wrench, Rod

AVAILABLE VARIANTS

5.0Ah	"Z" VARIANT
<b>DLM481 PT2</b> INCLUDES 2 BATTERIES / 1 TWO PORT CHARGER	<b>DLM481 Z</b> TOOL ONLY (DOES NOT INCLUDE BATTERY / CHARGER)

**DLM480 - 480mm** 18Vx2 **LXT**

**Cordless Lawn Mower**

Plastic Deck | Push Type | Rear Discharge



**Plastic Cutting Deck allows for lightweight design to increase maneuverability in turns, preparation, storage and more.**

- Multi-purpose 2-tooth blade for mowing and mulching
- Grass box with grass level indicator
- Single-lever cutting height adjustment
- Built-in ball bearing on axles for added durability
- Child lock key

Recommended mowing area **800 m<sup>2</sup>**

Runtime **28min**  
with BL1860B x 2 (push drive)

<b>Cutting Width</b>	480 mm
<b>Cutting Height</b>	20 - 100 mm
<b>Deck Type</b>	Plastic
<b>No. of stages</b>	10 stages
<b>No Load Speed (RPM)</b>	3,100
<b>Propelling speed</b>	-
<b>Dimensions (L x W x H)</b>	1,690 - 1,740 x 530 x 930 - 1,060 mm
<b>Net weight</b>	25.4 kg

**Standard Equipment:** Mulch Plug, Socket Wrench, Rod



AVAILABLE VARIANTS

5.0Ah	"Z" VARIANT
<b>DLM480 PT2</b> INCLUDES 2 BATTERIES / 1 TWO PORT CHARGER	<b>DLM480 Z</b> TOOL ONLY (DOES NOT INCLUDE BATTERY / CHARGER)

**DLM460 - 460mm** 18Vx2 **LXT**

**Cordless Lawn Mower**

Steel Deck | Push Type

**18vx2 460mm Cordless Lawn Mower with better usability.**

- 3 in 1 (Cutting, Collecting, Mulching)
- Grass box with grass level indicator
- Single-lever cutting height adjustment
- Built-in ball bearing on axles for added durability
- Child lock key
- 2-speed mode
- IPX4 : water resistant

Recommended mowing area **800 m<sup>2</sup>**

Runtime **21min**  
with BL1860B x 2 (push drive)

<b>Cutting Width</b>	460 mm
<b>Cutting Height</b>	20 - 75 mm
<b>No Load Speed (RPM)</b>	2,500 - 3,300
<b>Recommended mowing area</b>	6.0Ah x2: 800 - 1,600 m <sup>2</sup> / 5.0Ah x2: 680 - 1,360 m <sup>2</sup>
<b>Continuous Use (min.)</b>	6.0Ah: 21min / 5.0Ah: 18min / 3.0Ah: 10min
<b>Dimensions (L x W x H)</b>	During operation: 1,319-1,518x532x879-1,138 mm
<b>Net weight</b>	27.6 kg

**Standard Equipment:** Socket wrench

AVAILABLE VARIANTS

"Z" VARIANT
<b>DLM460 Z</b> TOOL ONLY (DOES NOT INCLUDE BATTERY / CHARGER)

**DLM431 - 460mm** 18Vx2 **LXT**

**Cordless Lawn Mower**

Plastic Deck | Push Type



**18vx2 430mm Cordless Lawn Mower with better usability.**

- Grass box with grass level indicator
- Single-lever cutting height adjustment
- Built-in ball bearing on axles for added durability
- Child lock key
- 2-speed mode

Recommended mowing area **475 m<sup>2</sup>**

Runtime **30min**  
with BL1850B x 2 (push drive)

<b>Cutting width</b>	430mm (17")
<b>Cutting height</b>	20-75mm
<b>No load speed (rpm)</b>	3,600
<b>Recommended mowing area</b>	500-1,000m <sup>2</sup>
<b>Grass box capacity</b>	50L
<b>Dimensions (L x W x H)</b>	1,450x460x950mm
<b>Max output</b>	730W
<b>Net weight</b>	18.0kg

**Standard Equipment:** Socket wrench

AVAILABLE VARIANTS

5.0Ah	"Z" VARIANT
<b>DLM431 PT2</b> INCLUDES 2 BATTERIES / 1 TWO PORT CHARGER	<b>DLM431 Z</b> TOOL ONLY (DOES NOT INCLUDE BATTERY / CHARGER)



- DRILLING / FIXING
- CONCRETE DRILLING / DEMOLITION
- MIXING / STIRRING
- CUTTING (CONCRETE / METAL)
- GRINDING
- SANDING / POLISHING
- SAWING
- MULTI-TOOL
- ROUTERS / PLANERS
- NAILERS / STAPLERS
- HEAT GUN / LASER
- CLEANING
- OPE
- JOBSITE TOOLS
- SPECIALTY TOOLS
- CARRY CASE / TOOL HOLDERS / POUCHES

- DRILLING / FIXING
- CONCRETE DRILLING / DEMOLITION
- MIXING / STIRRING
- CUTTING (CONCRETE / METAL)
- GRINDING
- SANDING / POLISHING
- SAWING
- MULTI-TOOL
- ROUTERS / PLANERS
- NAILERS / STAPLERS
- HEAT GUN / LASER
- CLEANING
- OPE
- JOBSITE TOOLS
- SPECIALTY TOOLS
- HAND TOOLS / COMBINATION SET
- TOOL HOLDERS AND POUCHES / MAKPAC SYSTEM

**DLM382 - 380mm**
**18Vx2 LXT**

**Cordless Lawn Mower**

**Plastic Deck | Push Type**

**18Vx2 380mm Cordless Lawn Mower with better usability.**

- Grass box with grass level indicator
- Single-lever cutting height adjustment
- Easy installation and removal of the grass box
- Child lock key
- Single speed mode

**Recommended mowing area**  
560m<sup>2</sup>

**Runtime**  
35min

<b>Cutting Width</b>	380 mm
<b>Cutting Height</b>	20 - 75 mm with BL1860B x 2 (push drive)
<b>Deck Type</b>	Plastic
<b>No. of stages</b>	13 stages
<b>No Load Speed (RPM)</b>	3,700
<b>Dimensions (L x W x H)</b>	1,380-1,410x450x985-1,005 mm
<b>Net weight</b>	16.9 kg

**Standard Equipment:** Socket wrench

**AVAILABLE VARIANTS**

**"Z" VARIANT**

**DLM382 Z**  
TOOL ONLY  
(DOES NOT INCLUDE BATTERY / CHARGER)

**DLM330 - 330mm**
**18V | LXT**

**Cordless Lawn Mower**

**Plastic Deck | Push Type**



**Plastic Cutting Deck allows for lightweight design to increase maneuverability in turns, preparation, storage and more.**

- Multi-purpose 2-tooth blade for mowing and mulching
- Grass box with grass level indicator
- Single-lever cutting height adjustment
- Built-in ball bearing on axles for added durability
- Child lock key

**Recommended mowing area**  
450m<sup>2</sup>

**Runtime**  
22min

<b>Cutting Width</b>	330 mm
<b>Cutting Height</b>	20 - 75 mm with BL1860B x 1 (push drive)
<b>Deck Type</b>	Plastic
<b>No. of stages</b>	8
<b>No Load Speed (RPM)</b>	4,300
<b>Dimensions (L x W x H)</b>	1,285 - 1,350 x 375 x 935 - 975 mm
<b>Net weight</b>	11.8 kg

**Standard Equipment:** Mulch Plug, Socket Wrench

**AVAILABLE VARIANTS**

<b>5.0Ah</b>	<b>"Z" VARIANT</b>
<b>DLM330 RT</b> <small>INCLUDES 1 BATTERY / 1 CHARGER</small>	<b>DLM330 Z</b> <small>TOOL ONLY (DOES NOT INCLUDE BATTERY / CHARGER)</small>

**ELM3320 330mm**

**Electric Lawn Mower**

**Plastic Deck | Push Type**



**Series motor**

- Designed to stand upright for easy maintenance and storage
- D-shaped cutting height adjusting lever
- Improved mowing efficiency
- Improved grass collection efficiency
- Light weight plastic deck.
- Smooth running

<b>Continuous rating input</b>	1,200W
<b>Motor</b>	Universal
<b>Cutting Width</b>	330 mm (13")
<b>Cutting Height</b>	20 - 55 mm (13/16" - 2-3/16")
<b>No Load Speed (RPM)</b>	3,400
<b>Recommended mowing area up to</b>	400 m <sup>2</sup>
<b>Grass box capacity</b>	30 L
<b>Wheel Size Front / Rear:</b>	139 / 178 mm (5-1/2 / 7")
<b>Vibration Level</b>	2.5 m/s <sup>2</sup> or less
<b>Sound Pressure Level</b>	83 dB(A)
<b>Sound Power Level</b>	94 dB(A)
<b>Dimensions (L x W x H)</b>	1,230x380x870 - 1,100 mm
<b>Net weight</b>	10.2 kg

**Standard Equipment:** Blade, Wrench

**ELM3720 370mm**

**Electric Lawn Mower**

**Plastic Deck | Push Type**



**Series motor**

- Designed to stand upright for easy maintenance and storage
- D-shaped cutting height adjusting lever
- Improved mowing efficiency
- Improved grass collection efficiency
- Light weight plastic deck.
- Smooth running

<b>Continuous rating input</b>	1,400W
<b>Motor</b>	Universal
<b>Cutting Width</b>	370 mm (14-1/2")
<b>Cutting Height</b>	20 - 55 mm (13/16" - 2-3/16")
<b>No Load Speed (RPM)</b>	3,400
<b>Recommended mowing area up to</b>	500 m <sup>2</sup>
<b>Grass box capacity</b>	40 L
<b>Wheel Size Front / Rear:</b>	139 / 178 mm (5-1/2 / 7")
<b>Vibration Level</b>	2.5 m/s <sup>2</sup> or less
<b>Sound Pressure Level</b>	83 dB(A)
<b>Sound Power Level</b>	94 dB(A)
<b>Dimensions (L x W x H)</b>	1,330x415x890 - 1,120 mm
<b>Net weight</b>	11.6 kg

**Standard Equipment:** Blade, Wrench

**PLM4120N** 410mm

**Petrol Lawn Mower**

**Steel Deck | Push Type**



**Increased maneuverability.**

- Light weight grass box.
- Cutting height can be adjusted at 5 stages by one handle.
- Large throttle knob is easy to grip.
- Rubber tire for gripping lawn.
- Plastic front cover protects the steel deck.

**P**

<b>Engine</b>	B&S500E, 140mL
<b>Cutting width</b>	410mm (16-1/8")
<b>Cutting height</b>	25, 31, 43, 56, 70mm
<b>Recommended mowing area</b>	1,000m <sup>2</sup>
<b>Grass box capacity</b>	50L
<b>Dimensions (L x W x H)</b>	760 x 500 x410mm
<b>Net weight</b>	26.0kg (57.3lbs)

**Standard Equipment:** Mulching Plug

**PLM4620N2** 460mm

**Petrol Lawn Mower**

**Steel Deck | Push Type**



**Powerful engine and more efficient performance**

- Powerful Briggs & Stratton Engine with ReadyStart function for Easy Start
- Edge trimming feature: able to cut close to walls and around obstacles obtained by offsetting blade position
- 2-in-1 feature for mulching and rear-discharging
- Ergonomic handle and soft grip for easy maneuvering
- Brake for maximum productivity and increased operator safety
- Single-lever cutting height adjustment with 5 positions

**P**

<b>Engine</b>	B&S625E R/S, 150mL
<b>Cutting width</b>	460mm
<b>Cutting height</b>	25, 31, 43, 56, 70mm
<b>Recommended mowing area</b>	Push type
<b>Grass box capacity</b>	1,200m <sup>2</sup>
<b>Dimensions (L x W x H)</b>	60L
<b>Net weight</b>	800x540x400mm 27.6 kg

**Standard Equipment:** Mulch Plug.

**PLM4621N2** 460mm

**Petrol Lawn Mower**

**Steel Deck | Self propelled**



**Self propelled, Powerful engine and more efficient performance**

- Powerful Briggs & Stratton Engine with ReadyStart function for Easy Start
- Edge trimming feature: able to cut close to walls and around obstacles obtained by offsetting blade position
- 2-in-1 feature for mulching and rear-discharging
- Ergonomic handle and soft grip for easy maneuvering
- Brake for maximum productivity and increased operator safety
- Single-lever cutting height adjustment with 5 positions

**P**

<b>Engine</b>	B&S650EXI R/S, 163mL
<b>Cutting width</b>	460mm
<b>Cutting height</b>	25, 31, 43, 56, 70mm
<b>Propelling speed</b>	Self propelling (1 speed)
<b>Recommended mowing</b>	1,400m <sup>2</sup>
<b>Grass box capacity</b>	60L
<b>Dimensions (L x W x H)</b>	800x540x410mm
<b>Net weight</b>	31.0 kg

**Standard Equipment:** Mulch Plug.

**PLM5113N2** 510mm

**Petrol Lawn Mower**

**Steel Deck | Self propelled**



**Self propelled, Powerful engine and more efficient performance**

- Powerful Briggs & Stratton Engine with ReadyStart function for Easy Start
- Edge trimming feature: able to cut close to walls and around obstacles obtained by offsetting blade position
- 3-in-1 feature for mulching and rear-discharging and side discharging
- Ergonomic handle and soft grip for easy maneuvering
- Brake for maximum productivity and increased operator safety
- Single-lever cutting height adjustment with 5 positions

**P**

<b>Engine</b>	B&S675EX1 R/S, 163mL
<b>Cutting width</b>	510mm
<b>Cutting height</b>	25, 31, 40, 53, 70mm
<b>Propelling speed</b>	Self propelling (3 speed)
<b>Recommended mowing</b>	2,000m <sup>2</sup>
<b>Grass box capacity</b>	65L
<b>Dimensions (L x W x H)</b>	890x570x440mm
<b>Net weight</b>	36kg

**Standard Equipment:** Mulch Plug.

- DRILLING / FIXING
- CONCRETE DRILLING / DEMOLITION
- MIXING / STIRRING
- CUTTING (CONCRETE / METAL)
- GRINDING
- SANDING / POLISHING
- SAWING
- MULTI-TOOL
- ROUTERS / PLANERS
- NAILERS / STAPLERS
- HEAT GUN / LASER
- CLEANING
- OPE**
- JOBSITE TOOLS
- SPECIALTY TOOLS
- HAND TOOLS / COMBINATION SET
- TOOL HOLDERS AND POUCHES / MAKPAC SYSTEM



# Blowers

## Cordless Blowers Comparison Chart

	<b>UB002C</b> connection cord	<b>UB001C</b> connection cord	<b>UB001G</b> 40V max	<b>DUB363</b> 36V LITHIUM-ION	<b>DUB362</b> 36V LITHIUM-ION	<b>DUB361</b> 36V LITHIUM-ION	<b>DUB184</b> 18V LITHIUM-ION	<b>DUB187</b> 18V LITHIUM-ION
<b>BLOWING FORCE</b>	<b>22N</b>	<b>20N</b>	<b>17N</b>	<b>14.4N</b>	<b>14.4N</b>	-	<b>10.9N</b>	<b>4.2N</b>
<b>MAX. AIR VELOCITY</b>	<b>71m/s</b>	<b>70m/s</b>	<b>64m/s</b>	<b>65m/s</b>	<b>54m/s</b>	<b>93m/s</b>	<b>52.1m/s</b>	<b>64m/s</b>
<b>MAX. AIR VOLUME</b>	<b>19m<sup>3</sup>/min</b>	<b>17.6m<sup>3</sup>/min</b>	<b>16m<sup>3</sup>/min</b>	<b>13.4m<sup>3</sup>/min</b>	<b>13.4m<sup>3</sup>/min</b>	<b>4.4m<sup>3</sup>/min</b>	<b>13m<sup>3</sup>/min</b>	<b>4.2m<sup>3</sup>/min</b>
<b>NOISE LEVEL</b>	<b>95.5dB(A)</b>	<b>92.9dB(A)</b>	<b>90dB(A)</b>	<b>96dB(A)</b>	<b>94dB(A)</b>	<b>94.7dB(A)</b>	<b>94dB(A)</b>	<b>94.3dB(A)</b>
<b>NET WEIGHT (without battery)</b>	<b>7.1Kg</b>	<b>2.1Kg</b>	<b>2.6Kg</b>	<b>3.5Kg</b>	<b>3.5Kg</b>	<b>2.5Kg</b>	<b>2.4Kg</b>	<b>3.3Kg</b>
<b>BOOST MODE</b>	X	✓	✓	X	X	X	X	X
<b>CRUISE CONTROL</b>	✓	✓	✓	✓	X	X	✓	✓

**UB001G** 40V MAX | 

**Cordless Blower**



Enough power to tackle any job, BL motor provides powerful blowing force Max 17N (with Boost Mode)

- In Boost mode, 17N max blowing force is always available
- High water-resistance (Wet Guard/ IPX4 compatible)
- High power and less user fatigue
- Compact and lightweight for single handed operation power level



VIDEO CLIP



<b>Max Air Volume</b>	CCMode: 0 - 13.5 m³/min   Boost Mode: 16.0 m³/min
<b>Max Air Velocity</b>	CCMode: 0 - 53 m/s   Boost Mode: 64 m/s
<b>Avg. Air Velocity</b>	CCMode: 0 - 44 m/s   Boost Mode: 53.5 m/s
<b>Blowing Force</b>	CCMode: 0 - 12N   Boost Mode: 17N
<b>No Load Speed (RPM)</b>	CCMode: 0 - 20,000   Boost Mode: 23,000
<b>Sound Pressure Level</b>	83.7 dB(A)
<b>Sound Power Level</b>	94.1 dB(A)
<b>Vibration Level</b>	2.5 m/s² or less
<b>Dimensions (L x W x H)</b>	960 - 1,017 x 167 x 297 mm
<b>Net weight</b>	2.6 kg (without battery)

Continuous use minutes: 15 - 8 mins (Cruise control mode: 0-max/ Boost mode)(with 5.0Ah battery) For longer runtime, pair the XGT blower with optional portable power source unit PDC1200 OR PDC01

AVAILABLE VARIANTS

<b>4.0Ah</b>	<b>"Z" VARIANT</b>
<b>UB001G M1</b> - 1PC OF BL4040 XGT BATTERY - FAST CHARGER DC40RA	<b>UB001G Z</b> TOOL ONLY (DOES NOT INCLUDE BATTERY / CHARGER)

**UB001C** 36V | 

**Cordless Blower**



Works with Portable Power Pack Units PDC1200 or PDC01 (sold separately)



Provides longer runtime to get through the largest jobs Achieved by connecting directly through power pack units

- Enough power to tackle any job, Powerful blowing force Max 20N 70 m/s max air velocity | 17.6m³/min max air volume
- Less user fatigue due to the battery weight transferred from the tool body to the portable power pack on user's back
- Low noise level; Smoother air ow, which is achieved by redesigning the position of controller and the air intake port, decreases noise while increasing blowing force



<b>Max Air Volume</b>	CCMode: 0 - 15.0 m³/min   Boost Mode: 17.6 m³/min
<b>Max Air Velocity</b>	CCMode: 0 - 60 m/s   Boost Mode: 70 m/s
<b>Avg. Air Velocity</b>	CCMode: 0 - 50 m/s   Boost Mode: 58 m/s
<b>Blowing Force</b>	CCMode: 0 - 15N   Boost Mode: 20N
<b>No Load Speed (RPM)</b>	CCMode: 0 - 21,000   Boost Mode: 24,000
<b>Sound Pressure / Power Level</b>	83.4 dB(A) / 91.4 dB(A)
<b>Vibration Level</b>	2.5 m/s² or less
<b>Dimensions (L x W x H)</b>	960 - 1,060 x 295 x 180 mm
<b>Net weight</b>	2.1 kg

AVAILABLE VARIANTS

<b>"Z" VARIANT</b>
<b>UB001C Z</b> TOOL ONLY (DOES NOT INCLUDE PORTABLE POWER PACK UNIT)

**UB002C** 36V | 

**Cordless Backpack Blower**



Works with Portable Power Pack Units PDC1200 or PDC01 (sold separately)



High power similar to 53cc engine backpack blower delivers high blowing force of 22 N for heavy debris

- Reduced user's arm fatigue from long continuous operation, due to the weights of the battery and the tool body transferred from the arm to back
- Low noise level with sound absorbing materials
- 3-stage telescopic long nozzle
- Variable speed control by trigger plus Cruise control lever
- The grip position is adjustable forward/ backward and left/right to suit user's size or work posture



<b>Max Air Volume</b>	w/ End nozzle: 0 - 19.0 m³/min; w/ Flat nozzle: 0 - 17.9 m³/min
<b>Max Air Velocity</b>	w/ End nozzle: 0 - 71.7 m/s; w/ Flat nozzle: 0 - 76.0 m/s
<b>Blowing Force</b>	0 - 22.0 N
<b>No load speed (RPM)</b>	0 - 22,000
<b>Continuous run time</b>	78 min
<b>Vibration level</b>	2.5 m/s² or less
<b>Sound pressure level</b>	80.9 dB(A)
<b>Sound power level</b>	95.5 dB(A)
<b>Dimensions (L x W x H)</b>	w/o Nozzle: 267 x 565 x 715 mm; w/ Nozzle: 1,368 x 694 x 715 mm
<b>Net Weight</b>	7.1 kg (without battery pack)

AVAILABLE VARIANTS

<b>"Z" VARIANT</b>
<b>UB002C Z</b> TOOL ONLY (DOES NOT INCLUDE PORTABLE POWER PACK UNIT)

**DUB362** 18Vx2 | 

**Cordless Blower**



18V X2 (36V) LXT BL Brushless Cordless Variable 6-Speed Blower

- Our most powerful cordless blower yet: Amazing 54 m/s & 13.4 m³/min operation
- Delivers up to 28 minutes of run time at 15,800RPM using 5.0Ah batteries
- 6-Stage air velocity/volume selection dial with variable speed control trigger
- 3-Stage telescopic long nozzle with adjustment range of 100 mm for user convenience



<b>Air volume</b>	6.9-13.4m³/min
<b>Air speed</b>	27-54m/s
<b>No load speed (rpm)</b>	11,400-21,500
<b>Sound power level</b>	96dB(A)
<b>Vibration level</b>	0.3m/s²
<b>Dimensions (L x W x H)</b>	830-930x205x295mm
<b>Net weight</b>	3.5kg

AVAILABLE VARIANTS

<b>"Z" VARIANT</b>
<b>DUB362 Z</b> TOOL ONLY (DOES NOT INCLUDE BATTERY / CHARGER)

DRILLING / FIXING

CONCRETE DRILLING / DEMOLITION

MIXING / STIRRING

CUTTING (CONCRETE / METAL)

GRINDING

SANDING / POLISHING

SAWING

MULTI-TOOL

ROUTERS / PLANERS

NAILERS / STAPLERS

HEAT GUN / LASER

CLEANING

OPE

JOBSITE TOOLS

SPECIALTY TOOLS

HAND TOOLS / COMBINATION SET

TOOL HOLDERS AND POUCHES / MAKPAC SYSTEM

- DRILLING / FIXING
- CONCRETE DRILLING / DEMOLITION
- MIXING / STIRRING
- CUTTING (CONCRETE / METAL)
- GRINDING
- SANDING / POLISHING
- SAWING
- MULTI-TOOL
- ROUTERS / PLANERS
- NAILERS / STAPLERS
- HEAT GUN / LASER
- CLEANING
- OPE
- JOB SITE TOOLS
- SPECIALTY TOOLS
- HAND TOOLS / COMBINATION SET
- TOOL HOLDERS AND POUCHES / MAKPAC SYSTEM

**18Vx2 LXT**

## DUB361

**Cordless Blower**



**18V X2 (36V) LXT Li-Ion Cordless 2-Speed Blower**

- Delivers up to 73 minutes of run time using two 4.0Ah 18V LXT batteries on low speed setting
- Makita-built motor produces a maximum air velocity of 93 m/s
- 2-Speed (10,000 & 17,000 RPM) design for optimum speed control
- Compact and lightweight for single handed operation
- Push button air volume selection (High / Low settings)



<b>Air volume</b>	Hi: 4.4m <sup>3</sup> /min / Lo: 2.3m <sup>3</sup> /min
<b>Air speed</b>	Hi: 93m/s / Lo: 57m/s
<b>No load speed (rpm)</b>	Hi: 17,000 / Lo: 10,000
<b>Sound pressure level</b>	82.3dB(A)
<b>Sound power level</b>	94.7dB(A)
<b>Dimensions (L x W x H)</b>	905 x 141 x 194mm
<b>Net weight</b>	2.5kg

**Standard Equipment:** Nozzle, Shoulder belt.

**AVAILABLE VARIANTS**

**"Z" VARIANT**

**DUB361 Z**  
TOOL ONLY  
(DOES NOT INCLUDE BATTERY / CHARGER)

## Blower + Vacuum (2 in 1 tool)









**18Vx2 LXT**

## DUB363

**Cordless Blower + Vacuum**





**50L**  
Dust bag capacity

**Runtime\***  
75 - 30  
min  
BL1850B x2

**Incredibly high power over 25ml engine blower**

- Powerful: Amazing 65 m/s operation
- Variable trigger switch + Cruise control lever allows you to lock the variable speed control trigger at the desired power level.
- Mulching function: A shredding blade cuts sucked fallen leaves into fine mulch
- Motor interlock system: The motor does not start up until the nozzle and fan cover have been properly installed
- 3-stage telescopic long nozzle with adjustment range of 100mm



<b>Max Air Volume</b>	13.4 m <sup>3</sup> /min (Blower) / 12.7 m <sup>3</sup> /min (Vacuum)
<b>Max Air Velocity</b>	3.2kPa (Blower)
<b>Max sealed suction</b>	65 m/s (Vacuum)
<b>Blowing Force</b>	14.4N
<b>No Load Speed (RPM)</b>	0 - 7,850
<b>Vibration level</b>	0.8m/s <sup>2</sup>
<b>Sound power level</b>	96dB(A)
<b>Dimensions (L x W x H)</b>	w/ 3-Stage Telescopic Long Nozzle: 737/786/836x200x415 mm
<b>Net weight</b>	3.5 kg (without battery)

**Standard Equipment:** Nozzle, Vacuum Kit, Shoulder belt.

**AVAILABLE VARIANTS**

**"Z" VARIANT**

**DUB363 ZV**  
TOOL + VACUUM KIT  
(DOES NOT INCLUDE BATTERY / CHARGER)

**18V | LXT**

## DUB187

**Cordless Blower + Vacuum**



**Compact solution with high power**

- Switching between Blowing and Vacuuming is made easy with a simple switch lever without changing any bag or nozzle
- Blower nozzle is mounted with wheels at the base to reduce the weight that user feels in their hand during operation



<b>No Load Speed (RPM)</b>	9,000 - 13,500
<b>Dust Bag Capacity</b>	25 L
<b>Max Air Volume</b>	Blower: 4.2 m <sup>3</sup> /min; Vacuum: 6.1 m <sup>3</sup> /min
<b>Max Air Velocity</b>	Blower: 64.0 m/s
<b>Blowing Force</b>	4.2N
<b>Max sealed suction</b>	Vacuum: 3.3 kPa
<b>Sound pressure level</b>	81.8 dB (A)
<b>Sound power level</b>	94.32 dB (A)
<b>Vibration Level</b>	2.5 m/s <sup>2</sup> or less
<b>Dimensions (LxWxH)</b>	1,168 x 164 x 416 mm
<b>Net weight</b>	3.32 kg (without battery)

**Standard Equipment:** Nozzle, Hex Wrench, Dust bag

**AVAILABLE VARIANTS**

**5.0Ah**

**"Z" VARIANT**

**DUB187 T002**  
1 BATTERY + 1 FAST CHARGER

**DUB187 Z**  
TOOL ONLY  
(DOES NOT INCLUDE BATTERY / CHARGER)



**DUB184** 18V | **LXT**

**Cordless Blower**



**18V LXT Li-Ion Powerful Cordless blower with BL motor**

- Ideal for clearing fallen leaves on pavement, grass and hedge clippings or other light debris
- Efficient clearing thanks to a high-efficiency axial fan similar to that of 18Vx2 LXT model DUB362
- Variable speed control by trigger, with Cruise control lever for lock-on operation



<b>Blowing force</b>	10.9N (with nozzle)
<b>Max Air volume</b>	13.0 m <sup>3</sup> /min (with nozzle)
<b>Max air velocity</b>	52.1 m/s (with nozzle)
<b>Air pressure</b>	5.8kPa
<b>Air outlet diameter</b>	ø40mm
<b>No load speed (rpm)</b>	0-18,000
<b>Continuous run time</b>	<b>6.0Ah:</b> 12mins / <b>5.0Ah:</b> 10mins
<b>Sound pressure level</b>	86.6 dB(A)
<b>Sound power level</b>	93.5 dB(A)
<b>Dimensions (L x W x H)</b>	825x160x285 mm
<b>Net weight</b>	3kg

**Standard Equipment:** Nozzle, Hex Wrench

AVAILABLE VARIANTS	
<b>5.0Ah</b>	<b>"Z" VARIANT</b>
<b>DUB184 RT</b> 1 BATTERY + 1 CHARGER	<b>DUB184 Z</b> TOOL ONLY (DOES NOT INCLUDE BATTERY / CHARGER)

**DUB185** 18V | **LXT**

**Cordless Compact Blower**



**18V LXT Li-Ion Cordless blower with 3 variable speed and increased air volume for higher blowing efficiency**

- Larger air volume has been obtained by increasing the air outlet diameter
- Compact and ergonomic design
- Lightweight for reduced operator fatigue
- Rubberized soft grip handle for increased operator comfort
- Vacuum option can enable with optional accessories



<b>Blowing force</b>	3.1N (with nozzle)
<b>Max Air volume</b>	3.2m <sup>3</sup> /min (without nozzle)
<b>Max air velocity</b>	98m/s (with nozzle)
<b>Air pressure</b>	5.8kPa
<b>Air outlet diameter</b>	ø40mm
<b>No load speed (rpm)</b>	0-18,000
<b>Continuous run time</b>	<b>5.0Ah:</b> Hi:21 / Mi:50 / Lo: 130mins / <b>3.0Ah:</b> Hi:13 / Mi:30 / Lo: 80mins
<b>Noise level</b>	83dB(A)
<b>Dimensions (L x W x H)</b>	517x156x210mm
<b>Net weight</b>	2.1kg

**Standard Equipment:** Nozzle

AVAILABLE VARIANTS	
<b>3.0Ah</b>	<b>"Z" VARIANT</b>
<b>DUB185 RF</b> 1 BATTERY + 1 CHARGER	<b>DUB185 Z</b> TOOL ONLY (DOES NOT INCLUDE BATTERY / CHARGER)

**UB100D** 

**Compact Electric Blower**



**Compact cordless Blower Powered by Slide Li-ion Battery of Makita's 12Vmax Platform**

- Variable speed control by trigger
- 3 air volume settings: Low, Medium, High
- Compact and lightweight design
- Ergonomic soft grip
- Vacuum function - can be used as a vacuum with a dust bag.



<b>Blowing Force</b>	1.8 N
<b>Max Air Volume</b>	2.6 m <sup>3</sup> /min
<b>Max Air Velocity</b>	75 m/s
<b>Max Sealed Suction</b>	4.0 kPa
<b>No Load Speed (RPM)</b>	0 - 15,800
<b>Run Time (min)</b>	High / Mid / Low
<b>Noise K Factor</b>	3 dB(A)
<b>Vibration Level</b>	508 x 155 x 202 mm (with 4.0Ah)
<b>Dimensions (L x W x H)</b>	2.5 m/s <sup>2</sup> or less
<b>Net weight</b>	1.9kg (with 4.0Ah)

**Standard Equipment:** Rubber Nozzle

AVAILABLE VARIANTS	
<b>"Z" VARIANT</b>	
<b>UB100D Z</b> TOOL ONLY (DOES NOT INCLUDE BATTERY / CHARGER)	

**UB1103** 

**Compact Electric Blower**



**High output air volume**

- Ergonomic designed handle with elastomer for more comfortable and controlled operation.
- With optional dust bag which allows to use as a vacuum.
- Self-standing design to put on the flat place/ turn upside down
- With variable speed control dial.



<b>Continuous rating Input</b>	600W
<b>Air volume</b>	0-4.1m <sup>3</sup> /min
<b>Air pressure</b>	0-5.7kPa (0-580mm H2O)
<b>No load speed (rpm)</b>	0-16,000
<b>Dimensions (L x W x H)</b>	479x185x178mm (18-7/8"x7-1/4"x7")
<b>Net weight</b>	2.0kg (4.3bs)
<b>Power supply cord</b>	2.5m (8.2ft)

**Standard Equipment:** Nozzle assembly and dust bag

- DRILLING / FIXING
- CONCRETE DRILLING / DEMOLITION
- MIXING / STIRRING
- CUTTING (CONCRETE / METAL)
- GRINDING
- SANDING / POLISHING
- SAWING
- MULTI-TOOL
- ROUTERS / PLANERS
- NAILERS / STAPLERS
- HEAT GUN / LASER
- CLEANING
- OPE
- JOB SITE TOOLS
- SPECIALTY TOOLS
- HAND TOOLS / COMBINATION SET
- TOOL HOLDERS AND POUCHES / MAKPAC SYSTEM

DRILLING /  
FIXING

CONCRETE  
DRILLING /  
DEMOLITION

MIXING /  
STIRRING

CUTTING  
(CONCRETE /  
METAL)

GRINDING

SANDING /  
POLISHING

SAWING

MULTI-TOOL

ROUTERS /  
PLANERS

NAILERS /  
STAPLERS

HEAT GUN /  
LASER

CLEANING

OPE

JOBSITE  
TOOLS

SPECIALTY  
TOOLS

HAND TOOLS /  
COMBINATION SET

TOOL HOLDERS  
AND POUCHES /  
MAKPAC SYSTEM

## UB1102



### Electric Blower



#### High output air volume

- Ergonomic designed handle with elastomer for more comfortable and controlled operation.
- With optional dust bag which allows to use as a vacuum.
- Self-standing design to put on the flat place/ turn upside down



Continuous rating Input	600W
Air volume	4.1m <sup>3</sup> /min
Air pressure	5.7kPa (580mm H2O)
No load speed (rpm)	16,000
Dimensions (L x W x H)	479x185x178mm (18-7/8"x7-1/4"x7")
Net weight	2.0kg (4.3bs)
Power supply cord	2.5m (8.2ft)

**Standard Equipment:** Nozzle assembly and dust bag

## BHX2500 24.5mL - 4 Stroke

### Petrol Blower



#### Take the hard work out of clearing leaves and garden debris.

- Clean exhaust emission and low fuel consumption.
- Compact and light weight.
- Mechanical decompression system for easy recoil pulling.
- Slim body for comfortable handling.



Displacement	24.5 mL
Power Rating	0.81 kW
Max Air Volume	10.1 m <sup>3</sup> /min
Max Air Velocity	65 m/s
Fuel Tank Capacity	0.52 L
Sound Pressure Level	88.7 dB(A)
Sound Power Level	102 dB(A)
Vibration Level	5.2 m/s <sup>2</sup>
No Load Speed (RPM)	3,500 - 7,800
Dimensions (L x W x H)	350x231x368 mm
Net weight	4.5 kg

**Standard Equipment:** Pipe, Nozzle, Socket Wrench

## EB7660TH 75.6 mL 4-stroke Tube-mounted throttle

### Petrol Backpack Blower



#### 75.6 mL MM4 Backpack Blower, Tube Throttle

- 92 m/s high air speed with 20 m<sup>3</sup>/min high volume MM4 engine for lower emissions and greater fuel economy for the demanding professional
- Heavy duty anti-vibration mounts between frame and engine for improved operator comfort
- Padded shoulder straps engineered with multiple adjustments for improved fit
- Padded back panel is ventilated for improved operator comfort
- Powerful fuel efficient 75.6 mL MM4 commercial duty engine



Displacement	75.6 mL
Power Rating	3.0 kW
Max Air Volume	20 m <sup>3</sup> /min
Max Air Velocity	92 m/s
Fuel Tank Capacity	1.9 L
No Load Speed (RPM)	2,800 - 7,200
Sound Pressure Level	102.8 dB(A)
Sound Power Level	110.7 dB(A)
Dimensions (L x W x H)	332x460x480 mm
Net weight	11.9kg

**Standard Equipment:** Oil bottle set, Box Wrench, Driver, Flexible Pipe, Swivel Pipe, Hose Clamp, End nozzle, Flat Nozzle, Long Pipe, Short Pipe, Accessory Bag, Cable Holder



### 3 in one tool - Blowing, Inflating and Deflating

- For wide range of applications from professional use to home use, such as various blow-off works, filter cleaning, inflation and deflation of inflatable toys and more
- Can also be used for deflating inner tubes, play pools and more, with Air vent hose (option) attached to the back of the machine
- Compact design easy to hold

**AS001G**
40V MAX |

**Cordless Dust Blower / Inflator / Deflator**

<b>Air volume</b>	Mode: 4/ 3/ 2/ 1: 1.1/ 1.0/ 0.8/ 0.6 m³/min
<b>Blowing force</b>	Mode: 4/ 3/ 2/ 1: 2.8/ 2.3/ 1.7/ 1.1 N
<b>Max sealed suction</b>	13.0 kPa
<b>Continuous Use (min.)</b>	Mode: 4/ 3/ 2/ 1: 13/ 17/ 25/ 50 (with BL4025)
<b>Sound pressure level</b>	79 dB(A)
<b>Vibration level</b>	2.5 m/s or less
<b>Dimensions (L x W x H)</b>	180 x 94 x 248 mm
<b>Net weight</b>	2.3 kg (without battery)

**Standard Equipment:** Nozzle 3, Nozzle 7, Nozzle 13, Pinch valve nozzle, Wide range nozzle, Belt clip,

**AVAILABLE VARIANTS**

2.0Ah	"Z" VARIANT
<b>AS001G A1</b> - 1PC BATTERY - FAST CHARGER - TOOL BAG	<b>AS001G Z</b> TOOL ONLY (DOES NOT INCLUDE BATTERY / CHARGER TOOL BAG)

**DAS180**
18V |

**Cordless Dust Blower / Inflator / Deflator**

<b>Air volume</b>	Mode: 4/ 3/ 2/ 1: 1.1/ 1.0/ 0.8/ 0.6 m³/min
<b>Blowing force</b>	Mode: 4/ 3/ 2/ 1: 2.8/ 2.3/ 1.7/ 1.1 N
<b>Max sealed suction</b>	13.0 kPa
<b>Continuous Use (min.)</b>	Mode 4 / 3 / 1 / 1: 15 / 20/ 30 / 55 (with BL1860B)
<b>Sound pressure level</b>	79 dB(A)
<b>Vibration level</b>	2.5 m/s or less
<b>Dimensions (L x W x H)</b>	173 x 92 x 247 mm
<b>Net weight</b>	0.82 kg (without battery)

**Standard Equipment:** Nozzle 3, Nozzle 7, Nozzle 13, Pinch valve nozzle, Wide range nozzle, Belt clip,

**AVAILABLE VARIANTS**

3.0Ah	"Z" VARIANT
<b>DAS180 RF</b> - 1PC BATTERY - FAST CHARGER - TOOL BAG	<b>DAS180 Z</b> TOOL ONLY (DOES NOT INCLUDE BATTERY / CHARGER / TOOL BAG)

## A wide range of applications Can be used for a wide range of applications by replacing the tip nozzle

Nozzle 13 Part No. 191X15-3	Nozzle 7 Part No. 191X13-7	Nozzle 3 Part No. 191X11-1	Wide nozzle Part No. 191X19-5	Flexible nozzle set Part No. 191X21-8	Pinch valve nozzle Part No. 191X17-9	Rubber attachment 20-30 set Part No. 191X25-0	Rubber attachment 65 set Part No. 191X27-6
<ul style="list-style-type: none"> <li>• For blow-off works</li> <li>• For inflating large play pools, etc.</li> </ul>	For filter cleaning	For cleaning narrow spaces (can be used like an air spray can)	Blowing air over dirt and liquid on desktop and wide-open area.	For blowing dust away from OA equipment or narrow spaces where this machine cannot enter	For inflating & deflating inner tubes and beach balls	For deflation large play pools and inflatable beds etc.*1	For deflating futon (bedding) compression bag*1

- DRILLING / FIXING
- CONCRETE DRILLING / DEMOLITION
- MIXING / STIRRING
- CUTTING (CONCRETE / METAL)
- GRINDING
- SANDING / POLISHING
- SAWING
- MULTI-TOOL
- ROUTERS / PLANERS
- NAILERS / STAPLERS
- HEAT GUN / LASER
- CLEANING
- OPE
- JOBSITE TOOLS
- SPECIALTY TOOLS
- HAND TOOLS / COMBINATION SET
- TOOL HOLDERS AND POUCHES / MAKPAC SYSTEM

# Spraying

Mist Blower and Sprayer



**PM001G** 40V MAX | **XGT**

**Cordless Backpack Mist Blower**

**NEW**



**High power cordless mist blower powered by 40Vmax XGT Li-Ion battery (two in parallel or one) provides 15N blowing force**

- Selectable with the button on control handle
- Cruise control level - Attachable to a desired position for desired control of spraying speed
- Compatible with ULV (Ultra Low Volume) spray for pesticides, etc (only available in High spraying speed mode)

**40V MAX XGT** **BL WG**

<b>Chemical tank capacity</b>	15.0 L (507 oz)
<b>Max air volume</b>	High / Med. / Low: 14.3 / 11.0 / 9.0 m <sup>3</sup> /min
<b>Max air velocity</b>	High / Med. / Low: 64.0 / 52.0 / 42.0 m/s
<b>Avg. air velocity</b>	High / Med. / Low: 53.0 / 43.0 / 34.0 m/s
<b>Vibration level</b>	2.5 or less
<b>Sound pressure level</b>	84.5 dB (A)
<b>Sound power level</b>	103.3 dB (A)
<b>Continuous Use (min.)</b>	w/ BL4080F x2 High: 20
<b>Dimensions (L x W x H)</b>	320 x 600 x 690 mm (without Nozzle)
<b>Net weight</b>	11.9 kg (without Battery)

**AVAILABLE VARIANTS**

<b>8.0Ah</b>	<b>"Z" VARIANT</b>
<b>PM001G L2</b> 2PCS OF 8.0AH BATTERY - 1PC TWO PORT FAST CHARGER DC40RB	<b>PM001G Z</b> TOOL ONLY (DOES NOT INCLUDE BATTERY / CHARGER)

**DUS158 - 15L** 18V | **LXT**

**Cordless Garden Sprayer**

**NEW**



**18V LXT Li-Ion Cordless 15L Garden Sprayer**

- For use with pesticides, insecticides, herbicides, fungicides and fertilizers
- Paddle switch under the grip of spray wand for easy on/off control of spraying
- Comfortably fitting harness and well-ventilated back pad
- I-shaped double head nozzle and Herbicide nozzle
- IP54-rated dust and shower-proof construction

**18V LXT** **XPT WG**

<b>Max Pressure</b>	0.5 Mpa
<b>Chemical tank</b>	15 L
<b>Hose Length</b>	1.7 m
<b>Continuous run time (min.)</b>	335 (with BL1850B, Double Outlet Nozzle) 460 (with BL1850B, Herbicide Nozzle)
<b>Spraying capacity (L)</b>	300 (with BL1850B, Double Outlet Nozzle) 780 (with BL1850B, Herbicide Nozzle)
<b>Dimensions (L x W x H)</b>	317 x 237 x 517 mm
<b>Net weight</b>	5.52 kg (without battery)

**Standard Equipment:** Upright double-headed nozzle, Wide-angle herbicide nozzle, Shoulder harness, Holder, Measure cup,

**AVAILABLE VARIANTS**

**"Z" VARIANT**

**DUS158 Z**  
TOOL ONLY  
(DOES NOT INCLUDE BATTERY / CHARGER)

**PM7650H** 75.6mL 4-stroke

**Petrol Backpack Mist Blower**



**75.6 mL MM4 Mist Blower**

- Efficient 4-Stroke Engine, No Fuel Mix Required
- Powerful fuel efficient 75.6 cc (3.67 HP), MM4 4-stroke, commercial duty engine
- L-shaped chemical tank lowers center of gravity for improved balance
- Single action switch to activate liquid chemical flow
- Padded shoulder straps retain their shape for easier re-shouldering

**MM4** **MAXI-MIX 4-STROKE ENGINE**

<b>Displacement</b>	75.6 mL
<b>Fuel Tank Capacity</b>	1.8 L
<b>Max Air Volume</b>	14.1 m <sup>3</sup> /min
<b>The velocity of the wind (without blower pipes)</b>	85 m/s
<b>Sound Pressure Level</b>	98.3 dB(A)
<b>Sound Power Level</b>	110.7 dB(A)
<b>Vibration Level</b>	3.5 m/s <sup>2</sup>
<b>Dimensions (L x W x H)</b>	420x440x595 mm
<b>Net weight</b>	13.9 kg

**Standard Equipment:** Oil bottle, Hand strap, Screwdriver, Diffusion cover, Hose clamp, Flexible pipe, Straight pipe

**DUS108 - 10L** 18V | **LXT**

**Cordless Garden Sprayer**

**NEW**



**18V LXT Li-Ion Cordless 10L Garden Sprayer**

- For use with pesticides, insecticides, herbicides, fungicides and fertilizers
- Paddle switch under the grip of spray wand for easy on/off control of spraying
- Comfortably fitting harness and well-ventilated back pad
- I-shaped double head nozzle and Herbicide nozzle
- IP54-rated dust and shower-proof construction

**18V LXT** **XPT WG**

<b>Max Pressure</b>	0.5 Mpa
<b>Chemical tank</b>	10 L
<b>Hose Length</b>	1.7 m
<b>Continuous run time (min.)</b>	335 (with BL1850B, Double Outlet Nozzle) 460 (with BL1850B, Herbicide Nozzle)
<b>Spraying capacity (L)</b>	300 (with BL1850B, Double Outlet Nozzle) 780 (with BL1850B, Herbicide Nozzle)
<b>Dimensions (L x W x H)</b>	317 x 237 x 437 mm
<b>Net weight</b>	5.22 kg (without battery)

**Standard Equipment:** Upright double-headed nozzle, Wide-angle herbicide nozzle, Shoulder harness, Holder, Measure cup,

**AVAILABLE VARIANTS**

**"Z" VARIANT**



**DUS108 Z**  
TOOL ONLY  
(DOES NOT INCLUDE BATTERY / CHARGER)

- DRILLING / FIXING
- CONCRETE DRILLING / DEMOLITION
- MIXING / STIRRING
- CUTTING (CONCRETE / METAL)
- GRINDING
- SANDING / POLISHING
- SAWING
- MULTI-TOOL
- ROUTERS / PLANERS
- NAILERS / STAPLERS
- HEAT GUN / LASER
- CLEANING
- OPE
- JOB SITE TOOLS
- SPECIALTY TOOLS
- HAND TOOLS / COMBINATION SET
- TOOL HOLDERS AND POUCHES / MAKPAC SYSTEM

- DRILLING / FIXING
- CONCRETE DRILLING / DEMOLITION
- MIXING / STIRRING
- CUTTING (CONCRETE / METAL)
- GRINDING
- SANDING / POLISHING
- SAWING
- MULTI-TOOL
- ROUTERS / PLANERS
- NAILERS / STAPLERS
- HEAT GUN / LASER
- CLEANING
- OPE
- JOBSITE TOOLS
- SPECIALTY TOOLS
- HAND TOOLS / COMBINATION SET
- TOOL HOLDERS AND POUCHES / MAKPAC SYSTEM

**DUS054** 5L
18V | **LXT**

**18V LXT - Cordless Garden Sprayer**

**18V LXT Li-Ion Cordless 5L Garden Sprayer**

- One / two head nozzle(s) can be selected
- Two head nozzles for a wide range of spray
- Lever at hand for easier operation
- Tank shape is optimized for easy fit
- Excellent water-resistant performance

	
<b>Max Pressure</b>	0.3 MPa
<b>Chemical tank</b>	5 L
<b>Hose Length</b>	1.7 m
<b>Spray Wand Length</b>	0.5 - 0.7 m
<b>Nozzle Mounting Thread</b>	G 1/4
<b>Continuous Use (min.)</b>	Spray Single: w/ BL1860B: 530 min
<b>Dimensions (L x W x H)</b>	343 x 182 x 368 mm
<b>Net weight</b>	2.9 kg (without battery)



**Standard Equipment:** H-Shaped Double Head Nozzle, Spray Wand, Spray Wand Holder, Shoulder Belt

**AVAILABLE VARIANTS**

**"Z" VARIANT**  
**DUS054 Z**  
TOOL ONLY  
(DOES NOT INCLUDE BATTERY / CHARGER)

**US053D** 5L
12V MAX | **CXT**

**12V MAX CXT - Cordless Garden Sprayer**

**12V MAX CXT Li-Ion Cordless 5L Garden Sprayer**

- One / two head nozzle(s) can be selected
- Two head nozzles for a wide range of spray
- Lever at hand for easier operation
- Tank shape is optimized for easy fit
- Excellent water-resistant performance

	
<b>Max Pressure</b>	0.3 MPa
<b>Chemical tank</b>	5 L
<b>Hose Length</b>	1.7 m
<b>Spray Wand Length</b>	0.5 - 0.7 m
<b>Nozzle Mounting Thread</b>	G 1/4
<b>Continuous Use (min.)</b>	Spray Single: w/ BL1041B : 250
<b>Dimensions (L x W x H)</b>	343 x 182 x 343 mm
<b>Net weight</b>	2.9 kg

**Standard Equipment:** H-Shaped Double Head Nozzle, Spray Wand, Spray Wand Holder, Shoulder Belt

**AVAILABLE VARIANTS**

**"Z" VARIANT**  
**US053D Z**  
TOOL ONLY  
(DOES NOT INCLUDE BATTERY / CHARGER)

**DVF104** 10L
18V | **LXT**

**Cordless Garden Sprayer**



**18V LXT Li-Ion Cordless 10 L Garden Sprayer**

- Environment-friendly with no emission and extremely low noise
- Hand valve lever with two selectable modes
- Reduced running cost with rechargeable Li-ion battery
- Compact and lightweight cordless sprayer provides easy handling and high maneuverability
- Two different nozzles included as standard equipment for added versatility

	
<b>Max Pressure</b>	0.3 MPa
<b>Chemical tank</b>	10 L
<b>Dimensions (L x W x H)</b>	315x225x415 mm
<b>Net weight</b>	4.1 kg



**Standard Equipment:** Upright Double-Headed Nozzle, Wide-Angle Herbicide Nozzle, Spray Pipe Holder, Shoulder Harness

**AVAILABLE VARIANTS**

**"Z" VARIANT**  
**DVF104 Z**  
TOOL ONLY  
(DOES NOT INCLUDE BATTERY / CHARGER)

**Evh2000** 24.5mL 4-stroke (Plunger pump type)

**Petrol Backpack Sprayer**





**Plunger pump type sprayer suitable for orchards, parks, gardens etc.**

- High water pressure is obtained using a plunger pump.



Features "Rapid Start" that allows to pull the starter rope with less force for extra-easy startup.

	
<b>Displacement</b>	24.5mL
<b>Fuel tank</b>	0.5L
<b>Max. pressure</b>	2.5Mpa (25kgf/cm <sup>2</sup> )
<b>Chemical tank</b>	20L
<b>Dimensions (L x W x H)</b>	380x420x635mm
<b>Net weight</b>	9.1kg (20.1lbs)

# Earth Auger Drill



DRILLING / FIXING

CONCRETE DRILLING / DEMOLITION

MIXING / STIRRING

CUTTING (CONCRETE / METAL)

GRINDING

SANDING / POLISHING

SAWING

MULTI-TOOL

ROUTERS / PLANERS

NAILERS / STAPLERS

HEAT GUN / LASER

CLEANING

OPE

JOBSITE TOOLS

SPECIALTY TOOLS

HAND TOOLS / COMBINATION SET

TOOL HOLDERS AND POUCHES / MAKPAC SYSTEM

## DG002G

40V MAX | XGT

### Cordless Earth Auger

NEW



- High Power Earth Auger with 40V max XGT system**
- Auger bits directly attached to the tool without using bit adapter
  - Earth auger attachment includes a bar which receives reaction force and an auxiliary handle, and helps the user drill holes in the ground easier
  - Reversing switch enables to extract, in reverse rotation mode, an auger bit jammed in soil with high resistance like clay soil
  - Lightweight design for reduced operator fatigue
  - BL motor delivers 1,500 RPM



Capacity	Sandy Soil: High / Low : 60 / 200 mm Clay Soil: High / Low : 60 / 150 mm
No Load Speed (RPM)	High / Low: 0 - 1,500 / 0 - 400
Max Fastening Torque	High: 55 N-m / Low: 136 N-m
Vibration Level	2.5 m/s <sup>2</sup> or less
Dimensions (L x W x H)	835 x 605 x 194 mm
Net weight	6.7 kg (without battery)

Standard Equipment: Chuck Key, Hex Wrench, Adapter

#### AVAILABLE VARIANTS

"Z" VARIANT

**DG002G Z**  
TOOL ONLY  
(DOES NOT INCLUDE BATTERY / CHARGER)

## DG001G

40V MAX | XGT

### Cordless Earth Auger



- High Power Earth Auger with 40V max XGT system**
- Earth auger attachment includes a bar which receives reaction force and an auxiliary handle, and helps the user drill holes in the ground easier
  - Reversing switch enables to extract, in reverse rotation mode, an auger bit jammed in soil with high resistance like clay soil
  - Lightweight design for reduced operator fatigue
  - Auger bit adapter enables to use the auger bits for popular engine earth augers
  - BL motor delivers 1,500 RPM



Capacity	Sandy Soil: High / Low : 60 / 200 mm Clay Soil: High / Low : 60 / 150 mm
No Load Speed (RPM)	High / Low: 0 - 1,500 / 0 - 400
Max Fastening Torque	High: 55 N-m / Low: 136 N-m
Vibration Level	2.5 m/s <sup>2</sup> or less
Dimensions (L x W x H)	863 x 605 x 199 mm
Net weight	6.7 kg (without battery)

Standard Equipment: Chuck Key, Hex Wrench, Adapter

#### AVAILABLE VARIANTS

4.0Ah

**DG001G M2**  
- 2PCS OF BL4040 XGT BATTERY  
- FAST CHARGER DC40RA

"Z" VARIANT

**DG001G Z**  
TOOL ONLY  
(DOES NOT INCLUDE BATTERY / CHARGER)

- DRILLING / FIXING
- CONCRETE DRILLING / DEMOLITION
- MIXING / STIRRING
- CUTTING (CONCRETE / METAL)
- GRINDING
- SANDING / POLISHING
- SAWING
- MULTI-TOOL
- ROUTERS / PLANERS
- NAILERS / STAPLERS
- HEAT GUN / LASER
- CLEANING
- OPE
- JOBSITE TOOLS
- SPECIALTY TOOLS
- HAND TOOLS / COMBINATION SET
- TOOL HOLDERS AND POUCHES / MAKPAC SYSTEM

**18Vx2 LXT**

## DDG461

### Cordless Earth Auger

**High Power Earth Auger with 36V LXT system**  
**Auger bits directly attached to the tool without using bit adapter**

- Earth auger attachment includes a bar which receives reaction force and an auxiliary handle, and helps the user drill holes in the ground easier
- Reversing switch enables to extract, in reverse rotation mode, an auger bit jammed in soil with high resistance like clay soil
- Lightweight design for reduced operator fatigue
- BL motor delivers 1,400 RPM

<b>Capacity</b>	Sandy Soil: High / Low : 60 / 200 mm Clay Soil: High / Low : 60 / 150 mm
<b>No Load Speed (RPM)</b>	High: 0 - 1,400 / Low: 0 - 350
<b>Dimensions (L x W x H)</b>	840 x 607 x 223 mm
<b>Net weight</b>	6.8 kg (without battery)

**Standard Equipment:** Hex Wrench

AVAILABLE VARIANTS

"Z" VARIANT

**DDG461 Z**  
 TOOL ONLY (DOES NOT INCLUDE BATTERY / CHARGER)

**18Vx2 LXT**

## DDG460

### Cordless Earth Auger

**High Power Earth Auger - Powered by two 18V Li-ion batteries**

- Earth auger attachment includes a bar which receives reaction force and an auxiliary handle, and helps the user drill holes in the ground easier
- Reversing switch enables to extract, in reverse rotation mode, an auger bit jammed in soil with high resistance like clay soil
- Lightweight design for reduced operator fatigue
- Auger bit adapter enables to use the auger bits for popular engine earth augers
- BL motor delivers 1,400 RPM

<b>Capacity</b>	Sandy Soil: High / Low : 60 / 200 mm Clay Soil: High / Low : 60 / 150 mm
<b>No Load Speed (RPM)</b>	High / Low: 0 - 1,400 / 0 - 350
<b>Vibration Level</b>	2.5 m/s <sup>2</sup> or less
<b>Dimensions (L x W x H)</b>	840 x 607 x 223 mm
<b>Net weight</b>	6.8 kg (without battery)

**Standard Equipment:** Chuck Key, Hex Wrench, Adapter

AVAILABLE VARIANTS

5.0Ah	"Z" VARIANT
<b>DDG460 T2</b> INCLUDES 2 BATTERIES / 1 TWO PORT CHARGER AND CARRY CASE	<b>DDG460 Z</b> TOOL ONLY (DOES NOT INCLUDE BATTERY / CHARGER)

## WHEEL BARROW

**18V | LXT**

## DCU180

### Powered Wheelbarrow

**Moving cart powered by LXT Li-ion battery**  
**Two variations: Carrier type and Bucket type**

- Bucket tray (Part no: 199008-0)
- Flat tray (Part no: 199009-8)

(Please note Flat bed tray or Bucket tray will not be supplied with the wheelbarrow and need to be ordered separately)

- Able to run with even one battery thanks to parallel battery connection.

<b>Max Run Time (min)</b>	with BL1860B: 120
<b>Max Load Capacity</b>	130 kg (290 lbs.)
<b>Traveling Speed</b>	Forward, High / Low: 0 - 3.5 / 0 - 1.5 km/h Reverse: 0 - 1 km/h
<b>Max Climbing Capacity</b>	12°
<b>Dimensions (L x W x H)</b>	When carrier is installed / During operation: 1,315x1,060x900 mm
<b>Net weight</b>	44.8 kg

**Standard Equipment:** Lock Key, Support Legs, Wrenches

AVAILABLE VARIANTS

"Z" VARIANT

**DCU180 Z**  
 TOOL ONLY (DOES NOT INCLUDE BATTERY / CHARGER / FLAT OR BUCKET TRAY)



**DCU602** 18Vx2 **LXT**

**Cordless Wheelbarrow (Bucket)**  
(Electric and Manual Dump)

**NEW** 

Frame carrier (optional) 191B67-2 

**Moving cart powered by 4 LXT batteries but operates using 2 batteries at a time to extend runtime**

- Max loading capacity : 300kg
- For heavy load which is difficult by manual dump
- Limits to stay at 0.8km/h speed when the bucket is tilted
- Forward: 2 wheels, Rear: 4 wheels (Front wheel drive)  
Forward (5.0km/h, 3.5km/h, 1.5km/h), Reverse (1.0km/h)
- Forward/reverse switch with speed selection switch
- Deadman brake - Brake will be activated when the accelerator trigger is released

<b>Max load capacity</b>	300 kg
<b>Traveling speed</b>	Forward, High / Low: 5 / 1.5 km/h Reverse: 1.0 km/h
<b>Max climbing capacity</b>	12°
<b>Dimensions (L x W x H)</b>	1,471x724x815-1,024
<b>Net weight</b>	143kg

**AVAILABLE VARIANTS**

**"Z" VARIANT**

**DCU602 Z**  
TOOL ONLY  
(DOES NOT INCLUDE BATTERY / CHARGER / FLAT OR BUCKET TRAY)

**DCU601** 18Vx2 **LXT**

**Cordless Wheelbarrow (Flat Tray)**  
(Electric Lift)

**NEW** 

**Moving cart powered by 4 LXT batteries but operates using 2 batteries at a time to extend runtime**

- Max loading capacity : 300kg
- Forward: 2 wheels, Rear: 4 wheels (Front wheel drive)  
Forward (5.0km/h, 3.5km/h, 1.5km/h), Reverse (1.0km/h)
- Forward/reverse switch with speed selection switch
- Deadman brake - Brake will be activated when the accelerator trigger is released

<b>Max load capacity</b>	300 kg
<b>Traveling speed</b>	Forward, High / Low: 5 / 1.5 km/h Reverse: 1.0 km/h
<b>Max climbing capacity</b>	12°
<b>Dimensions (L x W x H)</b>	1,391x724x815-1,024
<b>Net weight</b>	147 kg

**AVAILABLE VARIANTS**

**"Z" VARIANT**

**DCU601 Z**  
TOOL ONLY  
(DOES NOT INCLUDE BATTERY / CHARGER / FLAT OR BUCKET TRAY)

- DRILLING / FIXING
- CONCRETE DRILLING / DEMOLITION
- MIXING / STIRRING
- CUTTING (CONCRETE / METAL)
- GRINDING
- SANDING / POLISHING
- SAWING
- MULTI-TOOL
- ROUTERS / PLANERS
- NAILERS / STAPLERS
- HEAT GUN / LASER
- CLEANING
- OPE
- JBSITE TOOLS
- SPECIALTY TOOLS
- HAND TOOLS / COMBINATION SET
- TOOL HOLDERS AND POUCHES / MAKPAC SYSTEM



DRILLING /  
FIXING

CONCRETE  
DRILLING /  
DEMOLITION

MIXING /  
STIRRING

CUTTING  
(CONCRETE /  
METAL)

GRINDING

SANDING /  
POLISHING

SAWING

MULTI-TOOL

ROUTERS /  
PLANERS

NAILERS /  
STAPLERS

HEAT GUN /  
LASER

CLEANING

OPE

JOBSITE  
TOOLS

SPECIALTY  
TOOLS

HAND TOOLS /  
COMBINATION SET

TOOL HOLDERS  
AND POUCHES /  
MAKPAC SYSTEM

# GENERATORS



## Extreme reliability and durability are achieved Heavy Duty OHV engine

**Longer Operation**  
Fuel tank realizes continuously longer operation.

15L: EG2850A  
25L: EG4550A, EG5550A

**Extremely easy start**  
No kick-back Starting system

Recoil starter:  
EG2850A

Electric starter/ Recoil  
EG4550A, EG5550A  
(\* Battery is excluded)

**Indication lamp**  
The lamp lights up to indicate the generator is producing power.

**Oil Sensor equipped as a standard**

**Current meter and Voltage meter**

DC output  
12V - 8.3A

2 AC output  
50Hz - 230V

**Two wheels and handles for easy mobility**  
EG4550A, EG5550A only

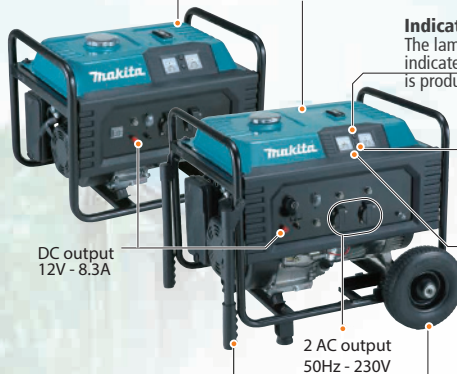

## EG2850A 2.8kVA

### Generator



### High Performance by OHV Engine and AVR Alternator

- Extreme reliability and durability
- Fuel tank realizes continuously longer operation
- No kick-back Starting system (Recoil starter)
- Oil sensor automatically shut off the engine whenever oil level is too low

Fuel tank	15L
Engine model	170F (210mL)
AC output	50Hz : 2.6kVA
Max. AC output VA	50Hz : 2.8kVA
Dimensions	600 x 442 x 450mm
Net weight	52.8kg (116.4bs)

**Standard Equipment:** Accessory tool set

**EG4550A 4.5kVA**

**Generator**



**High Performance by OHV Engine and AVR Alternator**

- Extreme reliability and durability
- Fuel tank realizes continuously longer operation
- No kick-back Starting system (Electric starter/ Recoil, battery is excluded)
- Oil sensor automatically shut off the engine whenever oil level is too low
- Two wheels and handles for easy mobility

<b>Fuel tank</b>	25L
<b>Engine model</b>	190F (420mL)
<b>AC output</b>	50Hz : 4.0kVA
<b>Max. AC output VA</b>	50Hz : 4.5kVA
<b>Dimensions</b>	680 x 550 x 550mm
<b>Net weight</b>	95.5kg (210.5lbs)

**Standard Equipment:** Accessory tool set

**EG5550A 5.5kVA**

**Generator**



**High Performance by OHV Engine and AVR Alternator**

- Extreme reliability and durability
- Fuel tank realizes continuously longer operation
- No kick-back Starting system (Electric starter/ Recoil, battery is excluded)
- Oil sensor automatically shut off the engine whenever oil level is too low
- Two wheels and handles for easy mobility

<b>Fuel tank</b>	25L
<b>Engine model</b>	190F (420mL)
<b>AC output</b>	50Hz : 5.0kVA
<b>Max. AC output VA</b>	50Hz : 5.5kVA
<b>Dimensions</b>	680 x 550 x 550mm
<b>Net weight</b>	98.5kg (217.2lbs)

**Standard Equipment:** Accessory tool set

DRILLING / FIXING

CONCRETE DRILLING / DEMOLITION

MIXING / STIRRING

CUTTING (CONCRETE / METAL)

GRINDING

SANDING / POLISHING

SAWING

MULTI-TOOL

ROUTERS / PLANERS

NAILERS / STAPLERS

HEAT GUN / LASER

CLEANING

OPE

JOBSITE TOOLS

SPECIALTY TOOLS

HAND TOOLS / COMBINATION SET

TOOL HOLDERS AND POUCHES / MAKPAC SYSTEM

# Multi Function Power Head Accessories

## Multi Function Power Head attachments

Able to meet a wide range of needs with only one power head

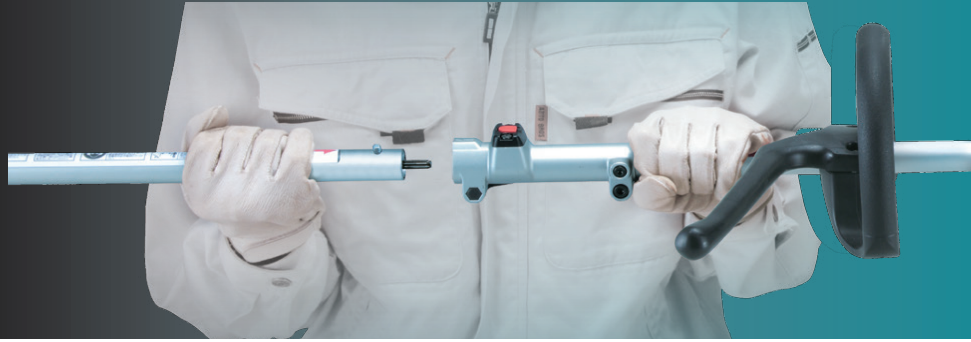

FOR MODEL : UX01G | DUX60 | DUX18

DRILLING / FIXING

CONCRETE DRILLING / DEMOLITION

MIXING / STIRRING

CUTTING (CONCRETE / METAL)

GRINDING

SANDING / POLISHING

SAWING

MULTI-TOOL

ROUTERS / PLANERS

NAILERS / STAPLERS

HEAT GUN / LASER

CLEANING

OPE

JOBSITE TOOLS

SPECIALTY TOOLS

HAND TOOLS / COMBINATION SET

TOOL HOLDERS AND POUCHES / MAKPAC SYSTEM



**Brushcutter**  
EM400MP  
195654-7

Cutting width  
Nylon head: 420mm

**Grass trimmer**  
EM408MP  
191N35-7

Cutting width  
Nylon head: 300mm  
Metal blade: 230mm  
Plastic blade: 255mm

ER400MP  
195528-2



**Rotary Scissors**  
EM407MP  
191M60-2

Cutting width:  
230mm  
The upper and lower metal blades rotate at low speed to cut grass just like scissors.



**Edger**  
EE400MP  
196752-0  
Blade dia : 203mm



Adjustable wheel for quick and easy adjustment to desired cutting depth

Metal skid plate protects gear housing for increased durability



**Ground Trimmer**  
suitable for undergrowth mowing that requires special attention for flying stone or kickback

EN420MP  
198060-5

Max cutting capacity:  
250mm



EN424MP  
1913D3-2

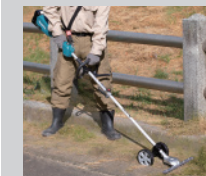

Easy grass trimming simply by pushing this attachment forward

Max cutting capacity:  
330mm



**Cultivator**

Excellent for cultivating small garden beds and between rows of vegetables or flowers



KR400MP  
195713-7

Cultivating width:  
160mm

KR401MP  
199188-2

Cultivating width:  
220mm



**Pole saw**  
EY401MP  
199926-2

Bar length : 250mm  
Saw chain : 91VXL  
-39links  
Gauge: 1.1  
Pitch: 3/8



**EY403MP**  
191T39-5

Bar length : 300mm  
Saw chain : 90PX-  
46links  
Gauge: 1.1  
Pitch: 3/8

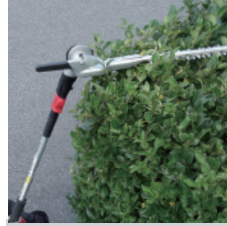

**Hedge trimmer**  
EN410MP  
197740-0

Max cutting capacity:  
490mm  
Teeth: 3 sharpened  
edges  
Thickness : 2mmMax  
branch diameter:  
22mm



Lighter than angle  
adjustable hedge  
trimmer attachment

**EN401MP**  
196342-9

Max cutting capacity:  
490mm  
Teeth: 3 sharpened  
edges  
Thickness : 2mm  
Max branch dia:  
21.5mm

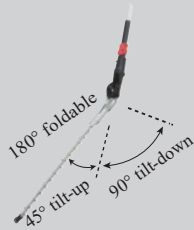

**Power brush**  
BR400MP  
199326-6



Cleaning of pavement  
with many joints and  
uneven stones  
using nylon brush.

Working width:  
600mm



**Power sweep**  
SW400MP  
199347-8



Sweeping dust, fallen  
leaves, or snow on  
the ground.

If the ground is hard  
and flat, water can be  
swept away  
from the surface.

Working width:  
590mm



**Water Pump**  
PF400MP  
BRAPF400MP ■

Designed to quickly  
extract water and  
making it perfect for  
a wide range of work  
sites, including  
irrigation,  
construction and  
more.

Water can be  
pumped up until  
it reaches a depth of  
10mm.

20mm is the lowest  
water level for  
starting operation



**Blower**  
UB400MP  
191F72-3

Blowing Force  
UX01G: 17.7N  
DUX60: 14.2N  
DUX18: 10.2N



**UB401MP**  
191P78-1  
With silencer

Blowing Force  
UX01G: 17.3N  
DUX60: 13.8N  
DUX18: 10.0N

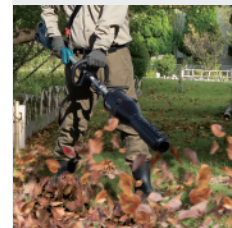

**UB402MP ■**  
191250-7  
Compact type

Blowing Force  
UX01G: 4.7N  
DUX60: 4.7N  
DUX18: 4.7N

**Shaft extension**

LE400MP  
196032-4 / 191E24-8

For Pole saw, Pole hedge trimmer



DRILLING  
/ FIXING

CONCRETE  
DRILLING /  
DEMOLITION

MIXING /  
STIRRING

CUTTING  
(CONCRETE /  
METAL)

GRINDING

SANDING /  
POLISHING

SAWING

MULTI-TOOL

ROUTERS /  
PLANERS

NAILERS /  
STAPLERS

HEAT GUN /  
LASER

CLEANING

OPE

JOBSITE  
TOOLS

SPECIALTY  
TOOLS

HAND TOOLS /  
COMBINATION SET

TOOL HOLDERS  
AND POUCHES /  
MAKPAC SYSTEM

# Chain Saw Accessories

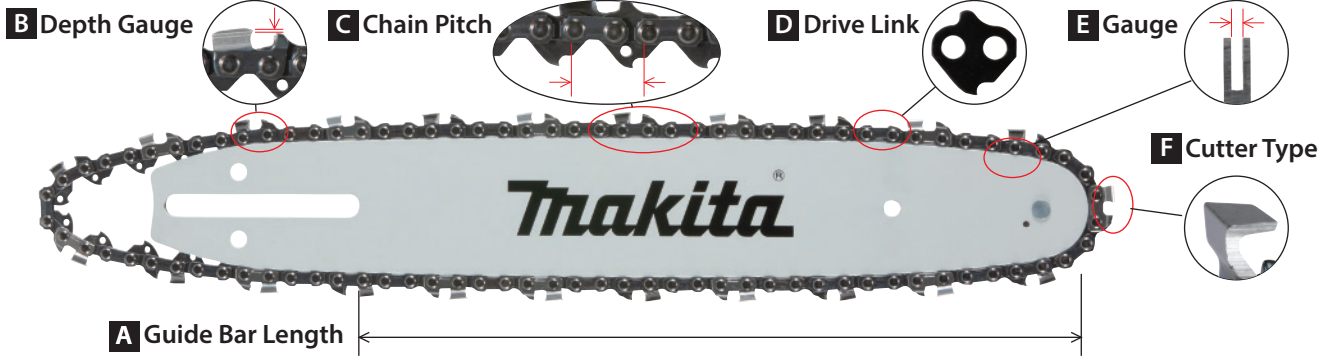

## A Guide Bar Length

Guide bar's length is represented by the cutting length, which is different from its total length.



## D Drive Link

The length of saw chain is determined by counting the number of drive links in the saw chain.

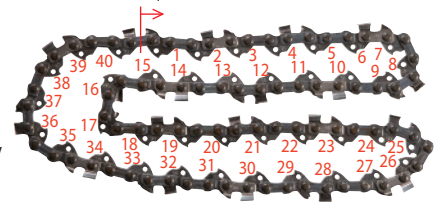

## B Depth Gauge

Depth gauge means the gap between the top of the depth gauge and the top of the cutter and determines how deep the cutting teeth gets into the wood.

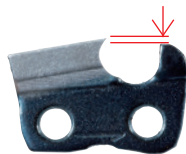

## E Gauge

Chain Gauge is the drive link's thickness where it fits into the guide bar groove, matching the guide bar gauge. The gauge of the chain and the gauge of the bar must match.

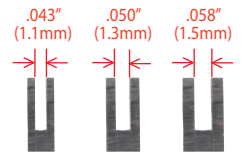

## C Chain Pitch

Chain pitch is the size of the chain, and is defined as the distance between any three consecutive rivets divided by two. Pitch is important because the drive sprocket must be the same pitch as the chain.



## F Cutter Type

F Cutter Type	MICRO CHISEL	SEMI CHISEL	CHAMFER CHISEL	FULL CHISEL
Abbreviation	MC	SC	CC	FC
End View				

## Guide Bar Type

### Sprocket Nose Bars

Sprocket nose bars have a rotating sprocket mounted on at the tip of the bar. As the chain moves along the bar, the sprocket teeth carry the chain around the tip smoothly with less friction.



### Hard Nose Bars (Solid Bar)

High wear resistant stellite is welded onto the tip. Hard nose bars are made for difficult situation, including fire-damaged forests, deserts, or sandy environments.



### Carving Bars

Carving bars are made of high-quality steel and high wear resistant stellite is welded onto the tip. The small nose radius is designed for precision cutting. The carving bars are made for especially pruning and carving.



## Guide Bar Maintenance

### Chain Tension

From time to time the saw chain tension before use. The saw chain may become loose after many hours of use.



### File Bar Edge

File bar edge with a flat file to keep 90° once a week.



### Clean Guide Bar

Clean out the chips and sawdust every time when you sharpen or replace the saw chain.

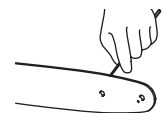

### Bar Nose Grease

Lubricate a whole sprocket regularly to make sure that the saw chain can rotate with less friction.

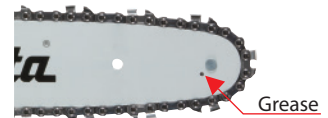

## Sharpening Saw Chain

### Round File and File holder



The file can be guided more easily if a file holder is employed. The file holder has markings for the correct sharpening angle of 30° (align the markings parallel to the saw chain) and limits the depth of penetration (to 4/5 of the file diameter).

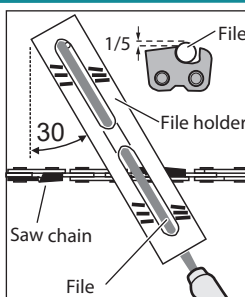

### Depth gauge jointer

After sharpening the chain, check the height of the depth gauge using the chain gauge tool.

### Flat file

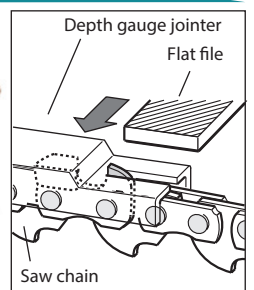

## Guide Bar, Saw Chain and Bar cover

Guide Bar

Saw Chain

Guide Bar Cover



Cutter Type:

CC: Chanfer chisel, FC: Full chisel, SC: Semi chisel

For Model	Bar length	Bar type	Guide Bar							Saw Chain		Bar Cover Part No.
			Part No.	New Part No.	Cutter type	Gauge	Pitch	Drive Links	Part No.	New Part No.		
EY401MP	25cm/10'	Sprocket		<b>191G11-9</b>	91VXL	SC	1.3mm	3/8"	39		<b>191H20-4</b>	452093-7
DUC101 UC100D	10cm/4'	Sprocket	-	<b>1910W0-3</b>	80TXL	MC	1.1mm	0.325'	26		<b>1910V6-4</b>	452093-7
UC002G, DUC254	25cm/10"	Sprocket		<b>191T85-8</b>	80TXL	MC	1.1mm	0.325'	46		<b>191T89-0</b>	452093-7
UC002G, UA004G, DUA301	25cm/10'	Sprocket	<b>161846-0</b>	<b>191G14-3</b>	90PX	CC	1.1mm	3/8"	40	<b>199075-5</b>	<b>191H00-0</b>	452093-7
DUC254, DUC252, EY403MP	25cm/10"	Sprocket	<b>168408-5</b>	<b>191G22-4</b>	91VG	SC	1.3mm	3/8"	40	<b>196205-9</b>	<b>191H08-4</b>	452093-7
UC002G, UC012G DUC254, DUC252, DUC307, DUC405, DCS34, DCS4610 UA004G, DUA301, EY403MP UC4041A, UC4551A	30cm/12"	Sprocket	<b>165245-8</b>		90PX	CC			46			452093-7
	30cm/12"	Sprocket	<b>442030661</b>	<b>191G23-2</b>	91PX	CC	1.3mm	3/8"	46		<b>191H10-7</b>	452093-7
UC002G, UC012G DUC254, DUC252, DUC307 DUC405, DCS34, DCS4610 UC4041A, UC4551A	35cm/14"	Sprocket	<b>442035661</b>	<b>191G24-0</b>	91PX	CC	1.3mm	3/8"	52	<b>531492652</b>	<b>191H11-5</b>	452093-7
UC012G DUC405	40cm/16"	Sprocket		<b>191T88-2</b>	80TXL	MC	1.1mm	0.325'	64		<b>191T92-1</b>	419560-5 952100633
UC012G, UC4041A, DUC307 DUC405,	40cm/16"	Sprocket	<b>165247-4</b>	<b>191G17-7</b>	90PX	CC	1.1mm	3/8"	56		<b>191H03-4</b>	419560-5 952100633
UC012G, DUC307, DUC405 DCS34, DCS4610 UC4041A, UC4551A	40cm/16"	Sprocket		<b>191G25-8</b>	91PX	CC	1.3mm	3/8"	56	<b>531492656</b>	<b>191H12-3</b>	419242-9
UC012G, UC4551A, EA4301F45B	45cm/18"	Sprocket		<b>191G26-6</b>	91PX	SC	1.3mm	3/8"	62	<b>713075-7</b>		419242-9
DCS430 DCS461 DCS460	38cm/15"	Sprocket			95VP	SC	1.3mm	0.325'	64	<b>532484064</b>		952010630
	45cm/18"	Sprocket			95VP	SC	1.3mm	0.325'	72	<b>532484072</b>		952020640
	38cm/15"	Sprocket	<b>443038651</b>		91VG	SC	1.3mm	3/8"	56			952010630
	45cm/18"	Sprocket	<b>445045651</b>	<b>191G51-7</b>	91VG	SC	1.3mm	3/8"	64	<b>523093664</b>	<b>191H43-2</b>	952020640
DCS461 DCS460 DCS5200	38cm/15"	Sprocket	<b>445038631</b>	<b>191G45-2</b>	21BP	SC	1.5mm	0.325'	64			952010630
	45cm/18"	Sprocket	<b>445045631</b>	<b>191G46-0</b>	21BP	SC	1.5mm	0.325'	72	<b>528086672</b>	<b>191H30-1</b>	952020640
	38cm/15'	Sprocket	<b>443038651</b>		73LP	FC	1.5mm	3/8"	56	<b>528099656</b>	<b>191H48-2</b>	952010630
	45cm/18"	Sprocket	<b>445045651</b>	<b>191G51-7</b>	73LP	FC	1.5mm	3/8"	64	<b>528099664</b>	<b>191H50-5</b>	952020640
	53cm/21"	Sprocket	<b>443053651</b>		73LP	FC	1.5mm	3/8"	72	<b>528099672</b> <b>528099772</b>	<b>191H52-1</b>	952020650
DCS6401 / DCS7301 / DCS7901 EA6100P	38cm/15"	Sprocket			73LP	FC	1.5mm	3/8'	60	<b>528099660</b>	<b>191H49-0</b>	
	50cm/20'	Sprocket	<b>445050655</b>		73LP	FC	1.5mm	3/8'	72	<b>528099672</b>	<b>191H52-1</b>	952100653
	45cm/18"	Solid	<b>445045455</b>		73LP	FC	1.5mm	3/8'	68	<b>528099668</b>	<b>191H51-3</b>	
	60cm/24'	Solid	<b>445060455</b>		73LP	FC	1.5mm	3/8'	84	<b>528099684</b> <b>528099784</b>	<b>191H54-7</b>	952100653
	70cm/28'	Solid	<b>445070455</b>		73LP	FC	1.5mm	3/8'	94	<b>528099694</b> <b>528099794</b>	<b>191H55-5</b>	952100171
DCS9010	74cm/30'	Solid	<b>445074452</b>		73LP	FC	1.5mm	3/8'	96	<b>528099696</b>	<b>191H56-3</b>	952100171
	84cm/33'	Solid	<b>445084422</b>		27	FC	1.5mm	0.404'	100	<b>522103700</b>		952100171
5012B	30cm/12"	Sprocket	<b>164533-0</b>		91VG	SC	1.3mm	3/8"	45	<b>196519-6</b>	<b>191H09-2</b>	
5016B	40cm/16"	Solid	<b>341650-5</b>		91VG	SC	1.3mm	3/8"	56	<b>196521-9</b>		

DRILLING /  
FIXING

CONCRETE  
DRILLING /  
DEMOLITION

MIXING /  
STIRRING

CUTTING  
(CONCRETE /  
METAL)

GRINDING

SANDING /  
POLISHING

SAWING

MULTI-TOOL

ROUTERS /  
PLANERS

NAILERS /  
STAPLERS

HEAT GUN /  
LASER

CLEANING

OPE

JOBSITE  
TOOLS

SPECIALTY  
TOOLS

HAND TOOLS /  
COMBINATION SET

TOOL HOLDERS  
AND POUCHES /  
MAKPAC SYSTEM

## Sharpening Set - in Roll-up Pouch

- $\varnothing$ 4.0mm round file (3pcs)
- File holder (1pc) with ergonomic handle and angled markings so you can align with chain saw chain
- Flat file (1pc) (150mm) with ergonomic handle for use with or without depth Gauge
- Handles (2pcs)
- Depth Gauge (1pc)



Part no.  
D-72154

## File and Handle

Round File Chain File Flat file Chain filing guage

dia. (mm)	Part no.	dia. (mm)	Part no.	dia. (mm)	Part no.	Part no.	for depth limiter	Part no.
4.0	953003090	4.5	953003100	4.8	953003070	744003-1	953003060	953100090



wooden

Part no.  
273646-7

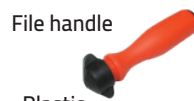

Plastic

Part no.  
953008020



File Holder

dia  
4.8

Part no.  
197712-5

## Screwdrivers

Size	Part no.	Size	Part no.	Size	Part no.	Size	Part no.	Part no.
T27	944500860	T27	940827000	T27 200mm	944500862	T27 100mm	944500861	944340001

## Wrenches

Universal Socket Wrenches



Size	Part no.	Size	Part no.	Size	Part no.
SW 13/19 mm	941719133	SW 17/19 mm	941717192	SW 13/16 mm	941716132

## Test and Diagnostic Tools

Size	Part no.	Size	Part no.
SW 17/19 mm	944500891	SW 13/16 mm	957004001

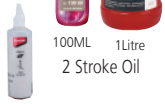

## Oil

	Type	Content	Part No.
<p><b>2 Stroke Engine Oil</b> - Makita High-performance 2 stroke engine oil is semi-synthetic oil with excellent lubricating qualities, low smoke and low carbon residue.</p> 	Chain Oil	100ml	182229-1
	2 Stroke Oil	100ml	195957-9
<p><b>4 Stroke Engine Oil</b> is a high performance lubricant formulated from a carefully balanced mixture of mineral base stocks fortified with the latest additive technology. 4 Stroke is suitable for all makes of four-stroke petrol and naturally aspirated diesel stationary engines found on horticultural machines.</p> 		1 Litre	980008607
	BIOTOP Chain Oil (Biodegradable)	1 Litre	980008610 / 1910U0-9
<p>Chain oil chain oiling is formulated to adhere to the bar and chain and to reduce wear. Adhesion additive helps keep sap and pitch from clinging to the bar and chain.</p> 		5 Litre	980008611
	Combination Fuel Can	5 L Petrol 2.5 L oil	949000035
<p>BIOTOP Chain oil With BIOTOP, chain oiling is safe for environment. BIOTOP is purely vegetable-based and readily biodegradable. It meets the strict requirements of the RAL UZ48 environment mark for environmental compatibility, lubrication, and aging resistance</p> 	4 Stroke Engine Oil	80 ml	197007-6
	4 Stroke Engine Oil	220 ml	195532-1

## Grass Shear / Pruning Shear blades

### Shear Blade for Grass shears



For models	Blade length	Blade assembly	Blade cover	Grass Receiver
DUM604, UM600D	160mm	195176-7	-	457426-1
DUM111	110mm	191N23-4	413885-9	454880-0

### Shear Blade Blade for ground trimmer

For models	Blade length	Blade assembly
EN424MP (1913D3-2)	330mm	1912V6-6

### Pruning Shear Blade

UP100D	Shear blade (U)	1911W2-5
UP100D	Shear blade (L)	1911W1-7

### Hedge Trimmer Blade for Grass shears

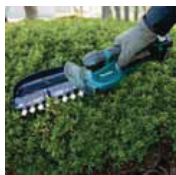

For models	Blade length	Blade assembly	Blade cover	Chip receiver
DUM604 UM600D	200mm	198409-9 198408-1	-	198401-5
DUM111	200mm	191N24-2	458342-0 195274-7 (with clank cover)	198401-5

### Long handle attachment for grass shears

- Long handle attachment with wheel enables to use the machine comfortably in a standing posture
- 5 stage angle adjustment allows for grip height adjustment according to user's height
  - Lock-off button operable from both left and right side

For models	Part No.
DUM111, DUM604, UM600D	198486-1



DRILLING / FIXING

CONCRETE DRILLING / DEMOLITION

MIXING / STIRRING

CUTTING (CONCRETE / METAL)

GRINDING

SANDING / POLISHING

SAWING

MULTI-TOOL

ROUTERS / PLANERS

NAILERS / STAPLERS

HEAT GUN / LASER

CLEANING

OPE

JOB SITE TOOLS

SPECIALTY TOOLS

HAND TOOLS / COMBINATION SET

TOOL HOLDERS AND POUCHES / MAKPAC SYSTEM

# Hedge Trimmer Accessories

DRILLING / FIXING

CONCRETE DRILLING / DEMOLITION

MIXING / STIRRING

CUTTING (CONCRETE / METAL)

GRINDING

SANDING / POLISHING

SAWING

MULTI-TOOL

ROUTERS / PLANERS

NAILERS / STAPLERS

HEAT GUN / LASER

CLEANING

OPE

JOBSITE TOOLS

SPECIALTY TOOLS

HAND TOOLS / COMBINATION SET

TOOL HOLDERS AND POUCHES / MAKPAC SYSTEM

## A: Curving blade

Optimum blade shape for smooth cutting

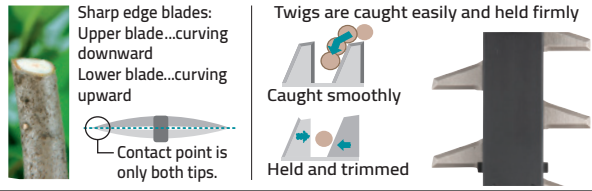

## B: High grade blade

Upper/ Lower blade teeth with 3 sharpened edges for clean cut.



Blade teeth with 3 sharpened edges. Well sharpened edges provide clean cut with the least branch damage.

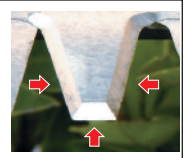

## C: Stain-free blade

Non-electrolyzed nickel plating. Evenly and strongly adhered surface coating that features high anti-abrasion surface for long lasting coating.



Sap on the blade (after 10 hour trimming of Boxwood)



## Chip Receiver for hedge trimmer

For efficient collection and clean-up of clippings

- D Without bind head screw M5X12 (P/N:915211-3 5pcs)
- E Easy one-touch installation and removal



## Hedge Trimmer Blade

	For Model	Type	Blade Size	Blade assembly Part No.	Upper blade Part No.	Lower blade Part No.	Blade Guard Part No.	Chip receiver
	EN401MP, EN410MP, EN4950H			197763-8				
	EN420MP			198195-2			457036-4	
	DUN461, UN460WD		460mm	191P00-8				
	UH014G	A	750mm	191Y05-2				D 191D34-9
	UH007G	B	750mm	191R56-3				E 191R52-1
	UH005G	A	750mm	191R54-7				E 191R52-1
	DUN500W		500mm	191C14-9				E 1910M5-3
	DUH507		500mm	1911J1-6				D 1910T1-0
	DUH607		600mm	1911J2-4				D 1910T2-8
	DUH606		600mm	1910H9-0				D 1910T2-8
	DUH551	C	550mm	196687-5				E 194681-1
	DUH754S	A	750mm	191D39-9				D 191D34-9
	DUH751	A	750mm	191R54-7			458408-6	
	UH5261	C	520mm	140827-7				
	UH4570	C	450mm	194660-9				
	UH6570	C	650mm	194666-7				
	UH7580	C	750mm	194675-6				
	UH6540				223233230	223233330		
	HTR5600				6018505400	6018505500		
	HTR7610				6018505200	6018505301		
	EH760				6018505200	6018505301		
	EH6000W			196797-8			454672-7	
	EH7500W			126779-6			454672-7	
	EH7500S			196801-3			346731-0	D 195321-4

## Edger Blade













Cuts clean sharp grass edges along beds and paths











Blade dia.	No. of teeth	Thickness	For model	Part No.
203mm	2T	2.5mm	EE2650H EE400MP	196745-7

# Brush Cutters Accessories

## Brush cutter Blade selection guide

Blade type / Image					
Nylon cord		←→			
Plastic blade		←→			
Metal blade		←→			
			←→		
Brushcutter blade			←→		
Shredder blade			←→		
Saw blade				←→	
Chisel blade				←→	
T.C.T. saw blade		←→			



																						
	Blade dia(mm)	270mm	230mm	255mm	305mm	230mm	255mm	200mm	230mm	255mm	230 mm	255mm	225mm	230mm	250mm	305mm		255mm		230mm		230mm
No. of teeth	2T	3T	3T	3T	4T	4T	8T	8T	8T	80T	24T	24T	36T	40T	M10x1.25LH	M8x1.25RH M8x1.25LH M10x1.25LH	M8x1.25RH / LH M10x1.25LH	M8x1.25RH				
Thickness	3.9	3.0	3.0	3.0	1.8	2.0	1.4	1.8		1.8		1.8	1.25	1.25								
Part No.	199874-5	D-66020	D-66036	D-66042	B-14118	B-14124	B-14130			B-14152	B-01921	199872-9	D-65981	D-65997	199868-0	198383-1	198384-9	198848-3	191Y45-0			
UR012G	•			•		•			•		•	•		•	•	•	•	•	•			
UR013G	•		•									•			•							
UR006G, 7G		•	•			•			•		•			•		•						
UR003G		•			•			•		•					•							
UR101C / 201C		•	•			•			•		•		•	•	•							
DUR369A		•				•			•		•		•	•	•							
DUR369N		•				•			•		•		•	•	•							
DUR364L															•	•						
DUR194							•															•
DUR190		•			•			•		•						•						
DUR189															•	•						
UR100D																			•			
EM400MP		•			•			•		•						•						
EM408MP		•			•			•		•						•						
EM2650UH		•			•			•		•						•						
EM4350RH		•		•	•	•		•	•	•			•	•		•						

■ UR013G: Protector guard (1911Y0-3) is must when using chisel blade / Protector guard (1911Y1-1) is must when using shredder blade  
 UR012G: Protector guard (199873-7) is must when using chisel blade / Protector guard (199875-3) is must when using shredder blade

Replacement plastic blades

199870-3 (12Pcs / Pkg)	198426-9 (12Pcs / Pkg)	198427-7 (12Pcs / Pkg)	198850-6 (5Pcs / Pkg)	198426-9 (12Pcs / Pkg)
---------------------------	---------------------------	---------------------------	--------------------------	---------------------------

### Rotary scissors blade

EM407MP	230mm	 	Rotary Scissors	A : SY00146013 B : SY00146014	Protection guard for EM407MP 412999-1
---------	-------	---	-----------------	----------------------------------	---------------------------------------

## Trimmer head Assembly

		Manual											
Type	B&F	B&F 4R	B&F 4L	B&F Z5L	B&f Z5L	95-M10L	95-M10L	B&F ECO 4R	76-M8R	95-M8R	UltraAuto 4R	UltraAuto 4L	SuperAuto XL
Size	5"	4"	4"	5"	5"	4"	4"	4"	3"	4"	4"	4"	
Arbore size	M12	M8x1.25RH	M8x1.25LH	M8x1.25LH	2.7mm X 3m	2.0mm x 2m	2.4mm x 3m	2.0mm x 3m	1.65mm x 3m	2.0mm x 3m	M8x1.25RH	M8&10x1.25LH	M8x1.25LH
Part No.	B-02951	A-89137	A-89121	A-89143	199884-2	198893-8	197804-0	197297-1	198853-0	198972-2	B-03006	B-02945 (with adapter)	B-01959
UR012G					•	•	•						
UR013G					•								
UR006G/7G						•	•						
UR003G						•	•						
UR101C						•	•						
UR102C						•	•						
DUR369A						•	•						
DUR369N						•	•						
DUR364L								•					
DUR190						•							
DUR192L						•	•						
DUR190						•	•						
DUR189								•		•			
UR100D									•				•
EM400MP	•					•	•					•	
EM408MP						•	•						
ER400MP		•	•	•				•			•		
EM2650UH	•					•	•					•	
EM4350RH	•						•						
RST250	•	•	•	•							•		

Eyelet 2pcs/set for Bump & Feed 4L/4R/Z5L, Ultra Auto 4R/4L/6L Part No. A-15992

### Spool Assembly

DUR193		191Y39-5
UR3000		DA00000001



## Trimmer head Assembly - Tap & go System (Four-leaf Nylon String)

Easy to replace nylon thread without dismantling the trimmer head

0  85(sec.)

General trimmer head					
	1. Disassemble trimmer head	2. Wind nylon cord on spool	3. Fix spool on trimmer head	4. Assemble trimmer head	5. Finish

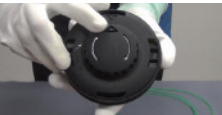

0  35(sec.)

Quick loading trimmer head (e.g. 96-M10L)				
	1. Align triangles	2. Feed the line	3. Twist the knob	4. Finish





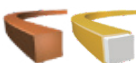



**Up to 58% less feeding time!**

Recommended Models	Size	Part No.	
DUR190L, DUR191L, DUR192L, DUR369A, DUR369N, UR003G, UR006G, UR007G, UR012G, UR101C, UR102C, EM400MP, EM401MP, EM403MP, EM408MP, EM4350U	4" M10x1.25LH   2mm x 4m M10x1.25LH   2mm x 3m	191D89-4 ■ 191D90-9	 Green Coloured Four-leaf Nylon String
UR012G, EM4350U, RBC411	5" M10x1.25LH   2.4mm x x 4m	191D93-3	 Orange Coloured Four-leaf Nylon String
UR013G	5" M10x1.25LH   2.7mm x x 2m	■ 191Y2-9	 Red Coloured Four-leaf Nylon String

**Line character**

Shape	Sharpness	Energy Saving	Quietness
Round 		A	A
Square 	AA		
Four-leaf 	A	AA	AA

**Color chart**

Dia.	Color / Shape	Light duty		Heavy duty	
		Low density	High density	Low density	High density
1.3mm		↔			
1.6mm - 1.65mm	 	↔↔			
2.0mm	 		↔↔↔		
2.4mm	  	↔↔↔↔			
2.7mm				↔↔↔↔↔	

- DRILLING / FIXING
- CONCRETE DRILLING / DEMOLITION
- MIXING / STIRRING
- CUTTING (CONCRETE / METAL)
- GRINDING
- SANDING / POLISHING
- SAWING
- MULTI-TOOL
- ROUTERS / PLANERS
- NAILERS / STAPLERS
- HEAT GUN / LASER
- CLEANING
- OPE
- JOB SITE TOOLS
- SPECIALTY TOOLS
- HAND TOOLS / COMBINATION SET
- TOOL HOLDERS AND POUCHES / MAKPAC SYSTEM

**Features of Nylon Cord (String) - Four Leaf Clover**

**Four-Leaf Line**

**Low noise and energy saving**

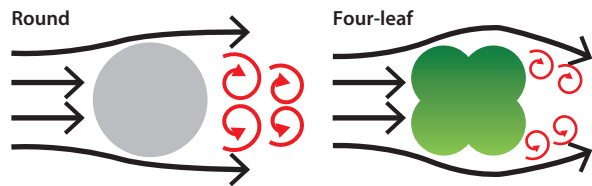

Four-leaf shape makes small vortex and realizes low noise and energy saving feature thanks to less air resistance.

The amount of cutting per 1 charge

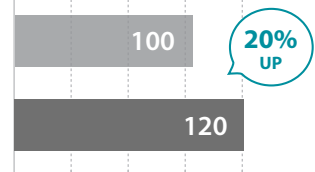

Noise

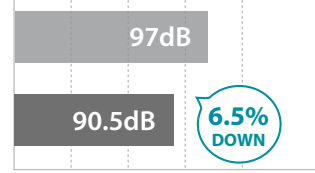

**Nylon Cord (String) - Four Leaf Clover**

- Well suited for use with high powered battery operated line trimmers
- More sharpness, about 10% less noise, and about 15% less power consumption compared with regular nylon cord

Spiral cord body with four-leaf clover-like cross section developed for better cutting performance

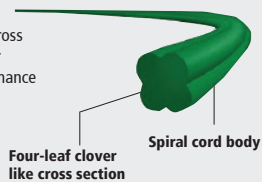

Colour	Size (mm)	Part no.
Red 	2.7mm-15meter	E-01828
Orange 	2.7mm-15meter	E-01797
Green 	2.0mm-15meter	197472-9
Blue 	1.65mm-15meter	E-01731

**Nylon Cord (String) - Square**

Square Shaped Nylon String  
For String Trimmers  
(For heavy duty application - cutting thick grass)



Size (mm)	Part no.
3.0mm x 219m	369224616



**Nylon Cord (String) - Round**



Size (mm)	Part no.
1.65mm x 15m	DA00000003
2.4mm x 5m	B-01971
3.0mm x 4m	B-07375
2.4mm x 1,425m	B-04612

# Blower Accessories

## Nozzles & adapter

	Adapter pipe (Adapter to connect to the flat nozzle and the gutter nozzle)	Flat nozzle set Narrow profile improves air speed for removing heavier debris such as wet leaves	Gutter nozzle set	Other Nozzles
DRILLING / FIXING				
CONCRETE DRILLING / DEMOLITION	UB001G UB001C	(85-72) 191L96-5	197889-6 used with Adapter 85-72	191B03-8 used with Adapter 85-72
MIXING / STIRRING	UB002C	(104-72) 1910M7-9 ■	456958-5 ■ used with Adapter 104-72	191B03-8 used with Adapter 104-72
CUTTING (CONCRETE / METAL)	DUB363	(90-72) 127501-4	197889-6 No adapter required	191B03-8 No adapter required
GRINDING	DUB362	(71) 191J13-3	197889-6 No adapter required	183R01-2 183R06-2 (End nozzle 72) (Pipe 90-72)
SANDING / POLISHING	DUB184	(80-72) 191B21-6	197889-6 used with Adapter 80-72	183R02-0 Long Nozzle Set
SAWING	UB400MP UB401MP	MG SET 191C15-7	197889-6 used with Adapter MG set	183P96-3 Front Nozzle Set

## Vacuum Set

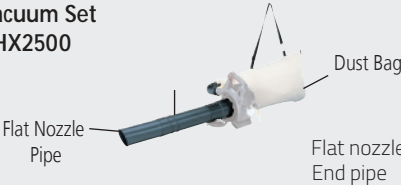
For Model	Part No.	For Model	Part No.
BHX2500	Nozzles are fixed DEABHX2500S	DUB363	191E19-1
BHX2500	Nozzles can be detached JPABHX2500S	Vacuum nozzle 191E19-1 contains the below items	
BHX2500	Nozzles can be detached 197234-5	 <p>459800-9    127425-4    127502-2</p> <p>Dust bag 162697-4    Shoulder belt 162698-2</p>	
<b>Vacuum Set</b> <b>BHX2500</b>  <p>Flat Nozzle Pipe    Dust Bag    Flat nozzle End pipe</p> <p>6659500901   457029-1 457030-6</p>			
DUB187	Dust bag Shoulder harness Wide Vacuum Nozzle with Roller	GB00000185 GB00000198 GB00000165	

## Flex Nozzle (allows concentrated airflow)

	For Model	Type	Size (mm)	Part No.
	DUB18, UB1100, UB1101, DVC350	Standard Equipment	220	132025-7
	DUB182, UB1100, UB1101, DVC350	-	430	134182-7
	UB1102, UB1103, UB100D, DUB185	Standard Equipment	220	123245-4
	UB1102, UB1103, UB100D, DUB185	-	430	123246-2

## Flexible Hose Set (for vacuum option)

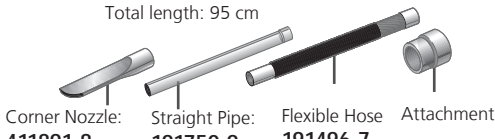
	For Model	Part No.
 <p>Total length: 95 cm</p> <p>Corner Nozzle: 411891-8    Straight Pipe: 191750-9    Flexible Hose: 191496-7    Attachment</p>	UB1100, UB1101, DUB182	191750-9
	UB1102, UB1103, UB100D, DUB185	196643-5

OPE

JOBSITE TOOLS

SPECIALTY TOOLS

HAND TOOLS / COMBINATION SET

TOOL HOLDERS AND POUCHES / MAKPAC SYSTEM

## Brush nozzle, Wiper Nozzle for blowers (UB1102/103, UB100D, DUB185)

### Brush nozzle set Part No. 191M30-1

To be connected using Flexible hose set Part No. 191M34-3

Specially designed to brush and blow away dust and fine debris, enabling easy sash cleaning or removal of dust or pollen from clothes

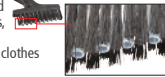

### Wiper nozzle set for blowing away water parts

Part No. 191M32-7

To be connected using Flexible hose set Part No. 191M34-3



### Flexible hose set

#### Part No. 191M34-3

For connecting the brush nozzle or the wiper nozzle to the main unit



## Dust Bag (cloth bag for efficient collection)

	For Model	Part No.
	UB1100, UB1101	122321-1
	UB1102/103, UB100D, DUB185	123241-2
	DUB182	122814-8
	UB0801V	GT31105808

## Attachments for AS001G / DAS180 Dust blower / inflator

Type		Part No.
Nozzle 13 set	<p>Nozzle diameter: <math>\phi</math>13mm                      - For blow-off works                      - For inflating large play pools, etc.</p>	191X15-3
Nozzle 7 set	<p>Nozzle diameter: <math>\phi</math>7.0mm                      - For filter cleaning</p>	191X13-7
Nozzle 3 set	<p>Nozzle diameter: <math>\phi</math>3.0mm</p>	191X11-1
Flexible nozzle Complete set	<p>Nozzle diameter: <math>\phi</math>6.0x800 (Hose)                      - For blowing dust away from equipment or narrow spaces</p>	191X21-8
Wide range nozzle set	<p>Nozzle diameter: <math>\phi</math>6.0mm (each hole)                      - For wide range blow-off</p>	191X19-5
Pinch valve nozzle set	<p>Nozzle diameter: <math>\phi</math>7.0mm                      For inflating/deflating</p>	191X17-9
Long nozzle set	<p>Nozzle diameter: <math>\phi</math>8.0mm                      - For cleaning anchor holes                      - For cleaning narrow spaces</p>	191X78-9
Air vent hose complete set	<p>Nozzle diameter: 13mm                      For inflating/deflating (Remove Dust cap complete from the machine and attach this hose.)</p>	191X23-4
Rubber attachment 20-30 set	<p>Nozzle diameter: 7.0mm                      For deflation large play pools and inflatable beds etc</p>	*191X25-0
Rubber attachment 65 set	<p>Nozzle diameter: <math>\phi</math>65mm                      For deflating futon (bedding) compression bag</p>	*191X27-6
Filter C complete set	<p>For use of the machine in a dusty environment (Remove Dust cap complete from the machine and attach this Filter.)</p>	191X29-2

\*Used by attaching to Nozzle 13 and Air vent hose

DRILLING / FIXING

CONCRETE DRILLING / DEMOLITION

MIXING / STIRRING

CUTTING (CONCRETE / METAL)

GRINDING

SANDING / POLISHING

SAWING

MULTI-TOOL

ROUTERS / PLANERS

NAILERS / STAPLERS

HEAT GUN / LASER

CLEANING

OPE

JOB SITE TOOLS

SPECIALTY TOOLS

HAND TOOLS / COMBINATION SET

TOOL HOLDERS AND POUCHES / MAKPAC SYSTEM

DRILLING /  
FIXING

CONCRETE  
DRILLING /  
DEMOLITION

MIXING /  
STIRRING

CUTTING  
(CONCRETE /  
METAL)

GRINDING

SANDING /  
POLISHING

SAWING

MULTI-TOOL

ROUTERS /  
PLANERS

NAILERS /  
STAPLERS

HEAT GUN /  
LASER

CLEANING

OPE



JOBSITE  
TOOLS

SPECIALTY  
TOOLS















HAND TOOLS /  
COMBINATION SET

TOOL HOLDERS  
AND POUCHES /  
MAKPAC SYSTEM

## Mist Blower Accessories

Type	For Model	Recommended use	Part no.
Diffusion Cover	PM001G	Diffuse the mist by attaching the diffusion cover to the end nozzle 	453506-1
Deflector Cover	PM001G	Discharge the mist upward or downward by attaching the deflector to the end nozzle 	198248-7
Band 25 Set	PM001G		196733-4

## Sprayer Accessories

	For Model	Recommended use	Part no.
Long two head nozzle 	EF1550RH, EVH2000	Wide spraying with wide angle outlet	6949001000
Y-shaped double nozzle 	DVF104	Ideal for herbicides and soil conditioning and watering applications	6958029000
Wide angle nozzle 	DVF104	Useful for pesticide, insecticide and fungicid applications	6958028000
Measuring Cup 	DUS054, US053D	-	PR00000180
Nozzle Head 	DUS054, US053D	-	PR00000142
Shoulder Strap 	DUS054, US053D	-	PR00000128
Spray wand 	DUS054, US053D	-	PR00000145
Wand Hook 	DUS054, US053D	-	PR00000144
Spray Hose Assembly 	DUS054, US053D	-	PR00000154
Handle Set 	DUS054, US053D	-	PR00000153
Handle Trigger Assembly 	DUS054, US053D	-	PR00000148
Twin Head Mist Nozzle Assembly 	DUS108_DUS158		■ PR00000255
Single Nozzle Assembly 	DUS108_DUS158		■ PR00000251
Spray Wand Assembly 	DUS108_DUS158		■ PR00000260
Shoulder Harness 	DUS108_DUS158		■ PR00000319



# Lawn Mower Accessories

## Lawn Mowers Blade



For Model	Size (mm)	Part no.
DLM330	330	GB00000042
DLM382	380	191D41-2
DLM460	460	199367-2
DLM431	430	197761-2
LM001C, DLM530, DLM531, DLM532, DLM533	530	191D52-7
LM004J, LM002J, LM002G, DLM538, DLM539	530	191V96-5
LM001J, DLM480, DLM481	480	191V97-3
ELM3310	330	671142202
ELM3320	330	YA00000745
ELM3311	330	671002550
ELM3710	370	671014142
ELM3711	370	671002549
ELM3720	370	YA00000746
ELM4110	410	671001427
PLM4110	410	671001433
PLM4120	410	671001433
ELM4610, ELM4611, ELM4612, ELM4613	460	671146102
PLM4620N, PLM4621N, PLM4622N	460	671014610
PLM4620N2, PLM4621N2, PLM4622N2	460	D671001451
PLM5113N2	510	DA00000973
PLM5112	510	664004381
High flow blade for better grass catching	DLM530, DLM532, DLM533, DLM538, DLM539, LM001C, LM002G, LM002J, LM004J	530 ■ 191W87-2
Mulching blade used without grass catcher	DLM530, DLM531, DLM532, DLM533, DLM538, DLM539, LM001C, LM002G, LM002J, LM004J	530 ■ 191Y65-4
	DLM530, DLM531, DLM532, DLM533, DLM538, DLM539, LM001C, LM002G, LM002J, LM004J	530 ■ 413L57-8

## Rotary lawnmower 4 swing back blade

- 4 swing back blades have been designed to withstand harsh conditions.
- 4 swing back blades provides a clean and efficient cut with reduced chance of solid objects being struck and causing damage.



For Model	Size (mm)	Part no.
LM001C, DLM531, DLM532, DLM533	530	191D50-1

Replacement blade (4 pc.): 191D48-8

DRILLING / FIXING

CONCRETE DRILLING / DEMOLITION

MIXING / STIRRING

CUTTING (CONCRETE / METAL)

GRINDING

SANDING / POLISHING

SAWING

MULTI-TOOL

ROUTERS / PLANERS

NAILERS / STAPLERS

HEAT GUN / LASER

CLEANING

OPE

JOB SITE TOOLS

SPECIALTY TOOLS

HAND TOOLS / COMBINATION SET

TOOL HOLDERS AND POUCHES / MAKPAC SYSTEM

# Earth auger drill bit series

DRILLING / FIXING

CONCRETE DRILLING / DEMOLITION

MIXING / STIRRING

CUTTING (CONCRETE / METAL)

GRINDING

SANDING / POLISHING

SAWING

MULTI-TOOL

ROUTERS / PLANERS

NAILERS / STAPLERS

HEAT GUN / LASER

CLEANING

OPE

JOBSITE TOOLS

SPECIALTY TOOLS

HAND TOOLS / COMBINATION SET

TOOL HOLDERS AND POUCHES / MAKPAC SYSTEM









With Earth auger

With Driver Drill

With Impact Wrench



Work example	Bit diameter											
	20mm 13/16"	25mm 1"	30mm 1-3/16"	35mm 1-3/8"	40mm 1-9/16"	50mm 2"	60mm 2-3/8"	80mm 3-5/32"	100mm 4"	150mm 6"	200mm 8"	
Holes for greenhouse pipes	←————→											
Holes for general pipes						←————→						
Holes for planting thin trunk trees							←————→					
Holes for general wooden stakes								←————→				
Holes for planting thick trunk trees									←————→			







For Model	Shank type	Image	Bit dia. (mm)	Length (mm)	Working length (mm)	Note	Part No.	
<b>Earth auger</b> 	Adapter D (327687-6) to connect with models DF001G, DDF460	With adapter D 	50	800	550	High speed drilling 50-80mm dia are suitable sizes for drilling holes for general pipes, thin truck trees  100-200mm dia are suitable for making wider holes to put thick trunk trees, wooden stakes	E-13611	
			60				E-13627	
			80				E-13633	
			100				E-07294	
			150				E-07303	
			200				E-07319	
			Extension bar 	-	540	-		E-07325
			Spare blade 	-	-	-	for Earth auger bit 50x800mm	E-13649
				-	-	-	for Earth auger bit 60x800mm	E-13655
				-	-	-	for Earth auger bit 80x800mm	E-13661
		-	-	-	for Earth auger bit 100x800mm	E-07630		
		-	-	-	for Earth auger bit 150x800mm	E-07646		
		Pin 	-	-	-		E-07331	
<b>13mm Driver drill with side grip</b> 	Hex shank		30	600	200	Shorter working length of the drill bits allow for drilling shallow holes. Ideal for use in fields and home gardens that do not require deep holes.	D-75415	
			45		200		D-75421	
			70		200		D-75437	
			100		240		D-75443	
			130		280		D-75459	
<b>3/4" Impact Wrench</b> 	3/4"	With socket, pin and O-ring 	20	600	530	Suitable for installing wooden/metal poles on the ground for preparing Greenhouse or farming and to be used for installing fence for camping sites and fixing poles in desert camp areas	B-54302	
			25				B-54318	
			30				B-54324	
			35				B-54330	

# OPE Maintenance Kits - Accessories





## Maintenance kit

<p>Maintenance kits comes with spark plug, air filter and fuel filter which are needed for scheduled maintenance to keep the tool in top working condition</p> 	For Model	Part No.
	EM2650UH/LH, EN4950H, EX2650, EY2650	197680-2
	RBC411	197690-9
	RBC2500, RST250	197688-6
	PM7650 / 51	198936-6
	EK7651	199003-0
EB7660TH, EB7660THG, EB7660VWH	198437-4	

## Shoulder Strap

					
DUR369A, UR002G, UR006G, UR007G, UR012G, UR013G	DUR369A, UR002G, UR006G, UR007G	DUN500W, DUR189, DUR190L, DUR192L, DUR194, DUR369A, DUA301, UA004G, UR100D, DUX60	DUR192L, DUR194, UR002G, UR003G; UR006G, UR007G, DUR193, DUR194	UB001C	UB001G, DUB184, DUB362, DVC350
Part no.	Part no.	Part no.	Part no.	Part no.	Part no.
122A37-4	122906-3	125516-5	127508-0	191J48-4	166094-6

			
DUB363	DUB187	DUS054, US053D	DUS108, DUS158
Part no.	Part no.	Part no.	Part no.
162698-2	GB00000198	PR00000128	PR00000319

## Holder

UC100D, DUC101



Part no.

1911R0-4

- DRILLING / FIXING
- CONCRETE DRILLING / DEMOLITION
- MIXING / STIRRING
- CUTTING (CONCRETE / METAL)
- GRINDING
- SANDING / POLISHING
- SAWING
- MULTI-TOOL
- ROUTERS / PLANERS
- NAILERS / STAPLERS
- HEAT GUN / LASER
- CLEANING
- OPE
- JOBSITE TOOLS
- SPECIALTY TOOLS
- HAND TOOLS / COMBINATION SET
- TOOL HOLDERS AND POUCHES / MAKPAC SYSTEM

# Leisure and Jobsite Tools

Makita cordless range also extends to useful leisure and jobsite tools such as Warmer-Cooler Box, Bluetooth Speakers, Radios, Inflators, Flashlights, and even has a cordless Coffee Maker



# Cordless Cooler & Warmer Box

## Keeps food and drinks Cool or Warm in any season



### Built with a highly durable design

#### IPX4 water resistance

Protection against water splash from all direction

### Portable for easy storage and transport



Compact and portable, fits in your vehicle and doesn't take too much space

**Wheels and a pull handle** for convenient transport

Side grips for easy lifting and shoulder strap for easy carrying (For CW004G, CW001G, CW003G, DCW180)

#### Built-in USB charging port

Enclosed battery compartment for keeping your batteries protected



#### LED display

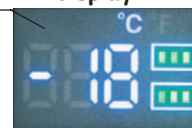

Provides a clear display of the inside temperature, set temperature and battery fuel gauge.

#### Bottle opener



#### CW003G

Capacity **7L**



#### CW001G DCW180

two in parallel or one battery



Capacity **20L**

#### CW004G

two in parallel or one battery



Capacity **29L**

#### CW002G

two in parallel or one battery



Capacity **50L**

CW002G
40V MAX | XGT 18V | LXT | AC

**Cordless Cooler & Warmer Box**

NEW

50L

**7 Cooling and Warm settings**  
**Compatible with 4 power sources**  
 XGT, LXT, 12V/24V DC Socket, AC Power

Note:- Cooler and Warmer box can operate with Two XGT battery (parallel) or Two LXT battery (parallel) or Combination of LXT and XGT battery

Capacity	50 L (13.2 gal)
Cooling System	Compressor
Cooling Capacity	-18 / -15 / -10 / -5 / 0 / 5 / 10°C (0 / 5 / 15 / 25 / 30 / 40 / 50°F)
Warming System	Heater
Warming Capacity	30 / 35 / 40 / 45 / 50 / 55 / 60°C (85 / 95 / 105 / 115 / 120 / 130 / 140°F)
Cord Length	AC Adapter / Cigar Socket Cable: 2 / 2.5 m (6.5 / 8.2 ft)
Dimensions (L x W x H)	867 x 465 x 476 mm
Net weight	25.6 kg

**Standard Equipment:** Automotive Charger Socket

AVAILABLE VARIANTS

Z VARIANT

**CW002G Z**  
 (DOES NOT INCLUDE BATTERY / CHARGER)

CW004G
40V MAX | XGT 18V | LXT | AC

**Cordless Cooler & Warmer Box**

NEW

29L

**17 Cooling and Warm settings and dual portion mode**  
 Storage of cooler box can be divided in to two portions with the partition plate. Two different temperature settings is possible for each divided portion with dual room mode option.

**Compatible with 4 power sources**  
 XGT, LXT, 12V/24V DC Socket, AC Power

Note:- Cooler and Warmer box can operate with Two XGT battery (parallel) or Two LXT battery (parallel) or Combination of LXT and XGT battery

Capacity	29 L (7.7 gal)
Cooling System	Compressor
Cooling Capacity	-18/-15/-10/-5/0/5/10/15/20/25/30/35/40/45/50/55/60°C
Warming System	Heater
Warming Capacity	(0/5/15/25/30/40/50/60/70/75/85/95/105/115/120/130/140°F) (Settable max temperature difference between two rooms: 30°C)
Cord Length	AC Adapter / Cigar Socket Cable: 2.2 / 2.5 m (6.5 / 8.2 ft)
Dimensions (L x W x H)	676 x 345 x 471 mm
Net weight	17.5 kg

**Standard Equipment:** Shoulder belt, Automotive Charger Socket

AVAILABLE VARIANTS

Z VARIANT

**CW004G Z**  
 (DOES NOT INCLUDE BATTERY / CHARGER)

- DRILLING / FIXING
- CONCRETE DRILLING / DEMOLITION
- MIXING / STIRRING
- CUTTING (CONCRETE / METAL)
- GRINDING
- SANDING / POLISHING
- SAWING
- MULTI-TOOL
- ROUTERS / PLANERS
- NAILERS / STAPLERS
- HEAT GUN / LASER
- CLEANING
- OPE
- JOBSITE TOOLS
- SPECIALTY TOOLS
- HAND TOOLS / COMBINATION SET
- TOOL HOLDERS AND POUCHES / MAKPAC SYSTEM

DRILLING / FIXING
CONCRETE DRILLING / DEMOLITION
MIXING / STIRRING
CUTTING (CONCRETE / METAL)
GRINDING
SANDING / POLISHING
SAWING
MULTI-TOOL

**CW001G** 40V MAX | XGT 18V | LXT

**Cordless Cooler & Warmer Box**

**20L**



**7 Cooling and Warm settings**  
**Compatible with 4 power sources**  
 XGT, LXT, 12V/24V DC Socket, AC Power

Note:- Cooler and Warmer box can operate with Two XGT battery (parallel) or Two LXT battery (parallel) or Combination of LXT and XGT battery

Capacity	20 L (5.3 gal)
Cooling System	Compressor type
Cooling Capacity	-18 / -15 / -10 / -5 / 0 / 5 / 10° (0 / 5 / 15 / 25 / 30 / 40 / 50°F)
Warming System	Heater
Warming Capacity	30 / 35 / 40 / 45 / 50 / 55 / 60°C (85 / 95 / 105 / 115 / 120 / 130 / 140°F)
	with BL4050F x 2, -18°C / 5°C / 60°C: 10h / 28h / 8.5h
Cord Length	AC Adapter / Cigar Socket Cable: 2 / 2.5 m
Dimensions (L x W x H)	663x341x372 mm
Net weight	13.5kg (without battery)

**Standard Equipment:** Automotive Charger Socket , Shoulder Strap

AVAILABLE VARIANTS

**Z VARIANT**

**CW001G Z**  
(DOES NOT INCLUDE BATTERY / CHARGER)

**CW003G** 40V MAX | XGT 18V | LXT

**Cordless Cooler & Warmer Box**

**7L**

**NEW**



**7 Cooling and Warm settings**  
**Compatible with 4 power sources**  
 XGT, LXT, 12V/24V DC Socket, AC Power

Note:- Cooler and Warmer box can operate with Two XGT battery (parallel) or Two LXT battery (parallel) or Combination of LXT and XGT battery

Capacity	7 L (1.8 gal)
Cooling System	Compressor type
Cooling Capacity	-18 / -15 / -10 / -5 / 0 / 5 / 10°C (0 / 5 / 15 / 25 / 30 / 40 / 50°F)
Warming System	Heater
Warming Capacity	30 / 35 / 40 / 45 / 50 / 55 / 60°C (85 / 95 / 105 / 115 / 120 / 130 / 140°F)
Run Time Hrs	with BL4040, -18 / 5 / 60°C: 5.5 / 13.5 / 5.5hrs
Cord Length	AC Adapter / Cigar Socket Cable: 2 / 2.5 m
Dimensions (L x W x H)	456 x 245 x 308 mm
Net weight	7.9kg (without battery)

**Standard Equipment:** Automotive Charger Socket, Shoulder Strap

AVAILABLE VARIANTS

**Z VARIANT**

**CW003G Z**  
(DOES NOT INCLUDE BATTERY / CHARGER)

ROUTERS / PLANERS
NAILERS / STAPLERS
HEAT GUN / LASER
CLEANING
OPE
JOBSITE TOOLS
SPECIALTY TOOLS
HAND TOOLS / COMBINATION SET
TOOL HOLDERS AND POUCHES / MAKPAC SYSTEM

**DCW180** 18V | LXT

**Cordless Cooler & Warmer Box**

**20L**



**Five Cooling and Two Warm settings.**  
**Compatible with 3 power sources**

- 12V/ 24V DC cigarette lighter socket for car, truck and boat
- Two LXT battery terminals for increased runtime. However cooler and warmer will operate on a single 18V LXT battery
- AC Power (through AC adapter)

Capacity	20 L (5.3 gal)
Cooling System	Compressor type
Cooling Capacity	-18 / -10 / 0 / 5 / 10°C (0 / 15 / 30 / 40 / 50°F)
Warming System	Heater
Warming Capacity	55 / 60°C (130 / 140°F)
	with BL1860B x 2 -18°C / 5°C / 60°C: 5 / 17 / 4 hrs
Cord Length	AC Adapter / Cigar Socket Cable: 2 / 2.5 m
Dimensions (L x W x H)	623x341x371.5 mm
Net weight	13 kg (without battery)

**Standard Equipment:** Ac Power Adapter, Automotive Charger Socket, Shoulder Strap

AVAILABLE VARIANTS

**"Z" VARIANT**

**DCW180 Z**  
(DOES NOT INCLUDE BATTERY / CHARGER)

**MW001G** 40V MAX | XGT

**Cordless Microwave**

**8L**

**NEW**



**The 40V Max XGT Microwave is compact and versatile with 8L of space for warming or defrosting food.**

- 2 power output modes high: 500W and Low: 350W in an inverter design without a spinning table.
- More energy efficient, evenly heating food without any hot or cold spots.
- High durable design with tempered glass door and dust and water-resistant construction
- Powered by a single 40V Max battery with two terminals for increased runtime.
- @500W power:- Up to15mins with 2x 4.0Ah batteries and up to 35mins with 2x 8.0Ah Batteries

Capacity	8 L (5.3 gal)
Output power	High: 500 W / Low: 350 W
USB port	Yes - 1 Port (2.4A)
Inside dimensions (L x W x H)	255 x 241 x 120 mm
Overall dimensions (L x W x H)	318 x 343 x 338mm
Net weight	9.9 kg (with 4.0Ah battery)



AVAILABLE VARIANTS

**"Z" VARIANT**

**MW001G Z**  
(DOES NOT INCLUDE BATTERY / CHARGER)



**DCM501**
18V | **LXT** 12V MAX | **CXT**

**Cordless Coffee Maker**

**Powered by either 18V LXT or 12V MAX CXT battery**

- Easy pouring water, Thanks to removable Water tank coffee machine can be kept without wetting
- Boil dry protection function automatically turns the coffee maker off if there is not enough water

<b>Water Tank Capacity</b>	240 mL
<b>Continuous rating: W</b>	190W (12V MAX) / 300W (18V-LXT)
<b>Brewing capacity (approx)</b>	260mL with 12v max 4.0Ah li-ion battery 320mL 18v LXT - 3.0Ah li-ion battery 640mL 18v LXT - 6.0Ah li-ion battery
<b>Brewing time of 1cup of coffee:</b>	7mins (160mL) (12V MAX) / 5mins (160mL) (18V-LXT)
<b>Dimensions (L x W x H)</b>	225x186x217 mm
<b>Net weight</b>	1.4 kg

**Standard Equipment:** Mug, Measuring Spoon

AVAILABLE SIZES

"Z" VARIANT

**DCM501 Z**  
(DOES NOT INCLUDE BATTERY / CHARGER OR CARRY CASE)

**KT001G**
40V MAX | **XGT**

**Cordless Kettle**



**Powered by two 40v Max XGT batteries in parallel (works with single XGT battery as well).**

- Dual layer structure of inner stainless layer and outer plastic layer provides high heat retention while keeping kettle surface cool
- Equipped with an anti-spill lock button to minimise accidental spilling of hot water
- Easy to carry around: Kettle can be transferred easily on power supply stand by holding the carrying handle of the stand
- Boil-dry protection, Auto shut-off after boiling with warning buzzer



<b>Boiling time (water)</b>	8 min (0.8L water from 23 °C)
<b>Water tank capacity</b>	0.8 L
<b>Dimensions (L x W)</b>	233 x 322 x 307mm
<b>Net weight</b>	1.0kg (without battery)

Mug Part No: KF00000020  
(240 mL)



AVAILABLE SIZES

"Z" VARIANT

**KT001G Z**  
(DOES NOT INCLUDE BATTERY / CHARGER OR CARRY CASE)

**DKT360**
18Vx2 | **LXT**

**Cordless Kettle**



**Powered by two 18V LXT Li-Ion batteries**

- Dual layer structure of inner stainless layer and outer plastic layer provides high heat retention while keeping kettle surface cool
- Equipped with an anti-spill lock button to minimise accidental spilling of hot water
- Easy to carry around: Kettle can be transferred easily on power supply stand by holding the carrying handle of the stand
- Boil-dry protection, Auto shut-off after boiling with warning buzzer



<b>Boiling time (water)</b>	8 min (0.8L water from 23 °C)
<b>Water tank capacity</b>	0.8 L
<b>Dimensions (L x W)</b>	233 x 263 x 307 mm
<b>Net weight</b>	1.0kg (without battery)

Mug Part No: KF00000020  
(240 mL)



AVAILABLE SIZES

"Z" VARIANT

**DKT360 Z**  
(DOES NOT INCLUDE BATTERY / CHARGER OR CARRY CASE)

- DRILLING / FIXING
- CONCRETE DRILLING / DEMOLITION
- MIXING / STIRRING
- CUTTING (CONCRETE / METAL)
- GRINDING
- SANDING / POLISHING
- SAWING
- MULTI-TOOL
- ROUTERS / PLANERS
- NAILERS / STAPLERS
- HEAT GUN / LASER
- CLEANING
- OPE
- JOBSITE TOOLS
- SPECIALTY TOOLS
- HAND TOOLS / COMBINATION SET
- TOOL HOLDERS AND POUCHES / MAKPAC SYSTEM

DRILLING / FIXING
CONCRETE DRILLING / DEMOLITION
MIXING / STIRRING
CUTTING (CONCRETE / METAL)
GRINDING
SANDING / POLISHING
SAWING
MULTI-TOOL
ROUTERS / PLANERS
NAILERS / STAPLERS
HEAT GUN / LASER
CLEANING
OPE
JOBSITE TOOLS
SPECIALTY TOOLS
HAND TOOLS / COMBINATION SET
TOOL HOLDERS AND POUCHES / MAKPAC SYSTEM

DFJ206 / DFJ207 / DFJ304 / DFJ405 / DFJ407

18V | **LXT** 12V MAX | **CXT**

**Cordless Fan Jacket**



DFJ206 DFJ207  
**For General Work**



DFJ304  
**For Grinding Work**



DFJ405 DFJ407  
**For Outdoor Work**

**Makita Cordless Fan jackets are works with LXT or CXT battery holders (Battery Holder will not come along with the Cordless fan jacket and will be available as an optional accessories)**

- Equipped with two pieces of flat fan units for increased comfort
- Fall prevention loops for fan units
- The strength of battery pockets are improved with two snap buttons
- Stand-up collar jackets: Cool air flows into helmet through stable stand-up collar for increased comfort
- Mesh pockets are provided on the back for storing ice packs



**Two Fan units to cool you down efficiently with more comfort**

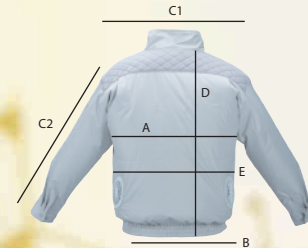
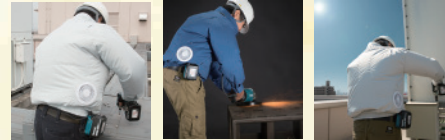

	size (in cm)	M	L	XL
A Chest width	A	121	126	131
B Waist	B	82	87	92
C1 Shoulder width	C1	54	56.5	59
C2 Sleeve length	C2	56	58	60
D Length	D	66	68	70
E Waist(MAX)	E	113	118	123



<b>Run Time (hrs)</b>	with BL1860B Low / Medium / High: 40 / 26.5 / 18.5
<b>Air Flow</b>	Turbo / High / Medium / Low: 2.1 / 1.9 / 1.5 / 1.3 m³/min
<b>Size</b>	M / L / XL
<b>Pockets</b>	5
<b>Net weight</b>	Jackets without hood: 360 g / Jackets with hood: 380 g

AVAILABLE SIZES (Z VARIANT)

FOR	CLOTH TYPE	COLLAR	MEDIUM	LARGE	EXTRA LARGE
General work	Polyester	Standup Collar	DFJ206 MZ	DFJ206 LZ	DFJ206 XLZ
General work	Polyester	With hood	DFJ207 MZ	DFJ207 LZ	DFJ207 XLZ
Grinding work	Cotton	Standup Collar	DFJ304 MZ	DFJ304 LZ	DFJ304 XLZ
Outdoor work	Titanium + Polyester	Standup Collar	DFJ405 MZ	DFJ405 LZ	DFJ405 XLZ
Outdoor work	Titanium + Polyester	With hood	DFJ407 MZ	DFJ407 LZ	DFJ407 XLZ

(CORDLESS FAN JACKETS DOES NOT INCLUDE THE BATTERY HOLDER OR BATTERY / CHARGER AND CARRY CASE)

**Accessories**

**Battery Holders**



**LXT battery holder** compatible with All 18V and 14.4V LXT Li-ion batteries  
**PART NO: 198732-2**



**CXT battery holder** compatible with All 10.8V/12V MAX CXT Li-ion batteries  
**PART NO: 198637-6**



Adapter comes with USB output port which can charge mobiles and other chargeable devices (usb cable is not part of the adapter)



DFJ212 / DFJ213 / DFJ214 / DFV210

18V | LXT 12V MAX | CXT

Cordless Fan Jacket

**Polyester**  
High-repellency fabric

Stand-up collar with stowaway hood

Casual type

DFJ212



**Polyester**  
Stretchable fabric

Stand-up collar Working wear type

DFJ213



**Polyester**  
Water repellency, antistatic fabric

Stand-up collar High-visibility type

DFJ214



**Polyester**  
High-repellency fabric

Stand-up collar Vest type

DFV210



Makita Cordless Fan jackets are works with LXT or CXT battery holders (Battery Holder will not come along with the Cordless fan jacket and will be available as an optional accessories)

- Selectable 3 air flow modes (High/ Medium/ Low) + Turbo mode
- Fan units equipped with BL motor
- Appearance is highly visible, form is hardly expandable and improves the comfort to wear. (only for DFJ214)
- Form is hardly expandable and improves the comfort to wear (only for DFV210/ DFJ212/ DFJ213)
- Stand-up collar jackets: Cool air flows into helmet through stable stand-up collar for increased comfort

# Stay cool in hot harsh job sites

Effective cooling air flow generated by two Fan units with BL motor



Insert supporting slider  
DFJ212  
DFV210



Velcro tabs for cuff adjustment  
DFJ212



Drawcord on hem for adjustable fit  
DFJ212  
DFV210



Zip fastener with quick release function  
DFJ213  
DFJ214



Snap button and rubber shirring for hem adjustment  
DFJ213  
DFJ214



Antistatic  
DFJ214



Retroreflective material  
DFJ214



Run Time (hrs)	33 / 24.5 / 13.5 hrs (with BL1860B)			
	13 / 9 / 5 hrs (with BL1041B)			
Size	M / L / XL / 2XL			
Pockets	5 (DFJ213) (DFJ214) / 4 (DFJ212) / 3 (DFV210)			
Net weight	0.43kg (DFJ212) / 0.54kg (DFJ213) (DFJ214) / 0.38kg (DFV210)			

AVAILABLE SIZES (Z VARIANT)

TYPE	MEDIUM	LARGE	EXTRA LARGE	2 EXTRA LARGE
Casual	DFJ212Z M	DFJ212Z L	DFJ212Z XL	DFJ212Z 2XL
Working wear	DFJ213Z M	DFJ213Z L	DFJ213Z XL	DFJ213Z 2XL
high visibility	DFJ214Z M	DFJ214Z L	DFJ214Z XL	DFJ214Z 2XL
Vest	DFV210Z M	DFV210Z L	DFV210Z XL	DFV210Z 2XL

(CORDLESS FAN JACKETS DOES NOT INCLUDE THE BATTERY HOLDER OR BATTERY / CHARGER AND CARRY CASE)

Accessories

Battery Holders

**LXT battery holder** compatible with All 18V and 14.4V LXT Li-ion batteries  
PART NO: 198732-2

**CXT battery holder** compatible with All 10.8V/12V MAX CXT Li-ion batteries  
PART NO: 198637-6



Adapter comes with USB output port which can charge mobiles and other chargeable devices (usb cable is not part of the adapter)

- DRILLING / FIXING
- CONCRETE DRILLING / DEMOLITION
- MIXING / STIRRING
- CUTTING (CONCRETE / METAL)
- GRINDING
- SANDING / POLISHING
- SAWING
- MULTI-TOOL
- ROUTERS / PLANERS
- NAILERS / STAPLERS
- HEAT GUN / LASER
- CLEANING
- OPE
- JOBSITE TOOLS
- SPECIALTY TOOLS
- HAND TOOLS / COMBINATION SET
- TOOL HOLDERS AND POUCHES / MAKPAC SYSTEM

- DRILLING / FIXING
- CONCRETE DRILLING / DEMOLITION
- MIXING / STIRRING
- CUTTING (CONCRETE / METAL)
- GRINDING
- SANDING / POLISHING
- SAWING
- MULTI-TOOL
- ROUTERS / PLANERS
- NAILERS / STAPLERS
- HEAT GUN / LASER
- CLEANING
- OPE
- JOBSITE TOOLS
- SPECIALTY TOOLS
- HAND TOOLS / COMBINATION SET
- TOOL HOLDERS AND POUCHES / MAKPAC SYSTEM

**DCV200**
18V | **LXT**

**Cordless Heated Vest**



**Stay warm in cold harsh job site environments.**

- Up to 28 hours of heat with BL1850(B) battery
- 2 core heat zones (shoulders & back) provide optimum heat distribution.
- 3 heat settings for precise heating control
- On/Off heat controller with 3 LED indicators



<b>Run Time (hrs)</b>	Low / Medium / High: 28 / 16 / 8 (with BL1850B)
<b>Heat Zones</b>	Total / Shoulders / Back: 2 / 1 / 1
<b>Heat Settings</b>	High / Medium / Low
<b>Available Size</b>	M / L / XL
<b>Pockets</b>	4
<b>Net weight</b>	0.66 kg (Jacket+fan)

**Standard Equipment:** Battery holder, pouch

**AVAILABLE SIZES**

Z VARIANT / Medium	Z VARIANT / Large	Z VARIANT / Extra Large
<b>DCV200 ZM</b> (DOES NOT INCLUDE BATTERY / CHARGER OR CARRY CASE)	<b>DCV200 ZL</b> (DOES NOT INCLUDE BATTERY / CHARGER OR CARRY CASE)	<b>DCV200 ZXL</b> (DOES NOT INCLUDE BATTERY / CHARGER OR CARRY CASE)





**MP001G**
40V MAX | **XGT**

**Cordless Inflator**



**Ideal for inflating tires of trucks and large vehicles etc.**

- 1,110kPa (161psi) maximum air pressure for inflating a wide variety of equipment
- High discharge volume at 24L/min for fast inflation times
- Air release function in case of over-inflation or to reduce the air pressure
- Large digital backlit display, shows current and target air pressure together
- 3 Inflation modes (High speed, Low speed or Ball modes)
- Auto-stop function, inflator shuts down once target pressure is achieved
- Rated operating time: 10 min On/ 5 min Off

<b>Air Discharge Amount</b>	200 kPa: 24 L/min   700 kPa: 12 L/min
<b>Max Air Pressure</b>	1,110 kPa (161 PSI) [11.1 bar]
<b>Hose Length</b>	65 cm
<b>Sound Pressure Level</b>	71 dB(A)
<b>Vibration Level</b>	3.8 m/s <sup>2</sup>
<b>Dimensions (L x W x H)</b>	272 x 108 x 231
<b>Net Weight</b>	2.2 kg (without battery)

**Standard Equipment:** British Adapter, French Adapter, Ball Adapter, Swim Ring Adapter

**AVAILABLE VARIANTS**

**"Z" VARIANT**

**MP001G Z**  
TOOL ONLY  
(DOES NOT INCLUDE BATTERY / CHARGER OR CARRY CASE)



**DMP181**
18V | **LXT**

**Cordless Inflator**



**Ideal for inflating tires of trucks and large vehicles etc.**

- 1,110kPa (161psi) maximum air pressure for inflating a wide variety of equipment
- High discharge volume at 24L/min for fast inflation times
- Air release function in case of over-inflation or to reduce the air pressure
- Large digital backlit display, shows current and target air pressure together
- 3 Inflation modes (High speed, Low speed or Ball modes)
- Auto-stop function, inflator shuts down once target pressure is achieved
- Rated operating time: 10 min On/ 5 min Off

<b>Air Discharge Amount</b>	200 kPa: 22 L/min   700 kPa: 11 L/min
<b>Max Air Pressure</b>	1,110 kPa (161 PSI) [11.1 bar]
<b>Hose Length</b>	65 cm (25-1/2")
<b>Sound Pressure Level</b>	70 dB(A)
<b>Vibration Level</b>	3.6 m/s <sup>2</sup>
<b>Dimensions (L x W x H)</b>	272 x 108 x 231
<b>Net Weight</b>	2.1kg (without battery)

**Standard Equipment:** British Adapter, French Adapter, Ball Adapter, Swim Ring Adapter

**AVAILABLE VARIANTS**

**"Z" VARIANT**

**DMP181 Z**  
TOOL ONLY  
(DOES NOT INCLUDE BATTERY / CHARGER OR CARRY CASE)

**DMP180** 18V | **LXT**

**Cordless Inflator**



**Compact inflator for inflating tires of Car, Bike, Cycle and also the beach toys**

- 830kPa (111psi) maximum air pressure for inflating a wide variety of equipment
- Digital pressure indicator shows current or target air pressure
- 3 Inflation modes (High speed, Low speed or Ball modes)
- Auto-stop function, inflator shuts down once target pressure is achieved
- Rated operating time: 5 min On/ 5 min Off

**3** **18V** **LXT**

<b>Max air Pressure</b>	830 kPa (121 PSI) [8.3 bar]
<b>Air Discharge Amount</b>	200 kPa: 10 L/min
<b>Hose Length</b>	65 cm (25-1/2")
<b>Dimensions (L x W x H)</b>	w/ BL1860B: 266x76x174 mm
<b>Net weight</b>	1.0 kg (without battery)

**Standard Equipment:** British Adapter, French Adapter, Ball Adapter, Swim Ring Adapter

**AVAILABLE VARIANTS**

**"Z" VARIANT**

**DMP180 Z**  
(DOES NOT INCLUDE BATTERY / CHARGER OR CARRY CASE)

**MP100D** 12V MAX | **CXT**

**Cordless Inflator**



**Compact inflator for inflating tires of Car, Bike, Cycle and also the beach toys**

- 830kPa (111psi) maximum air pressure for inflating a wide variety of equipment
- Digital pressure indicator shows current or target air pressure
- 3 Inflation modes (High speed, Low speed or Ball modes)
- Auto-stop function, inflator shuts down once target pressure is achieved
- Rated operating time: 5 min On/ 5 min Off

**3** **12V MAX** **CXT**

<b>Max air Pressure</b>	830 kPa (121PSI)
<b>Air Discharge Amount</b>	200 kPa: 10 L/min
<b>Hose Length</b>	65 cm (25-1/2")
<b>Dimensions (L x W x H)</b>	w/ BL1021B: 235x74x173 mm
	w/ BL1041B: 255x74x173 mm
<b>Net weight</b>	0.97 kg (without battery)







**Standard Equipment:** British Adapter, French Adapter, Ball Adapter, Swim Ring Adapter

**AVAILABLE VARIANTS**

**"Z" VARIANT**

**MP100D Z**  
(DOES NOT INCLUDE BATTERY / CHARGER OR CARRY CASE)





**Inflators work amount comparison chart**

	Light Truck	Car	Tractor	Bicycle	Road Bike	Ball	Beach ball / Swim ring
Valve shape							
Adapter				British Part No. TE00000597	French Part No. TE00000594	For Balls Part No. TE00000592	Swim rings Beach balls Part No. TE00000333
	Light Truck Tyre	Regular Car Tyre	Tractor Tyre	Bicycle Tyre	Road Bike Tyre	Ball Tyre	Beach Ball
Objects Conditions	Size: 305/70R16 0+600kPa High Speed Mode	Size: 215/60R16 0+250kPa High Speed Mode	Size: 7 - 14 0+180kPa High Speed Mode	Size: 26 inch 0+300kPa Low Speed Mode	Size: 700x23C 0+700kPa High Speed Mode	Size: 700x23C 0+90kPa Ball Mode	Size: 30cm High Speed Mode
MP00IG Work amount (BL4040)	4 times	19 times	32 times	780 times	125 times	310 times	140 times
DMP181 Work amount (BL1860B)	3 times	14 times	25 times	500 times	110 times	230 times	120 times
DMP180 Work amount (BL1850B)	-	9 times	-	166 times	92 times	142 times	121 times
MP100D Work amount (BL1020)	-	2 times	-	46 times	20 times	63 times	54 times

All the above values are approximate and calculated with the fully charged battery

**Air chuck for double tire** - Used for a big vehicle such as truck or bus. Able to inflate the backside of double tire

Air chuck (head angle 30 degrees) - TE00000691 ■ Air chuck (head angle 0 degree) - TE00000796 ■

- DRILLING / FIXING
- CONCRETE DRILLING / DEMOLITION
- MIXING / STIRRING
- CUTTING (CONCRETE / METAL)
- GRINDING
- SANDING / POLISHING
- SAWING
- MULTI-TOOL
- ROUTERS / PLANERS
- NAILERS / STAPLERS
- HEAT GUN / LASER
- CLEANING
- OPE
- JOBSITE TOOLS
- SPECIALTY TOOLS
- HAND TOOLS / COMBINATION SET
- TOOL HOLDERS AND POUCHES / MAKPAC SYSTEM

# Lighting Coverage



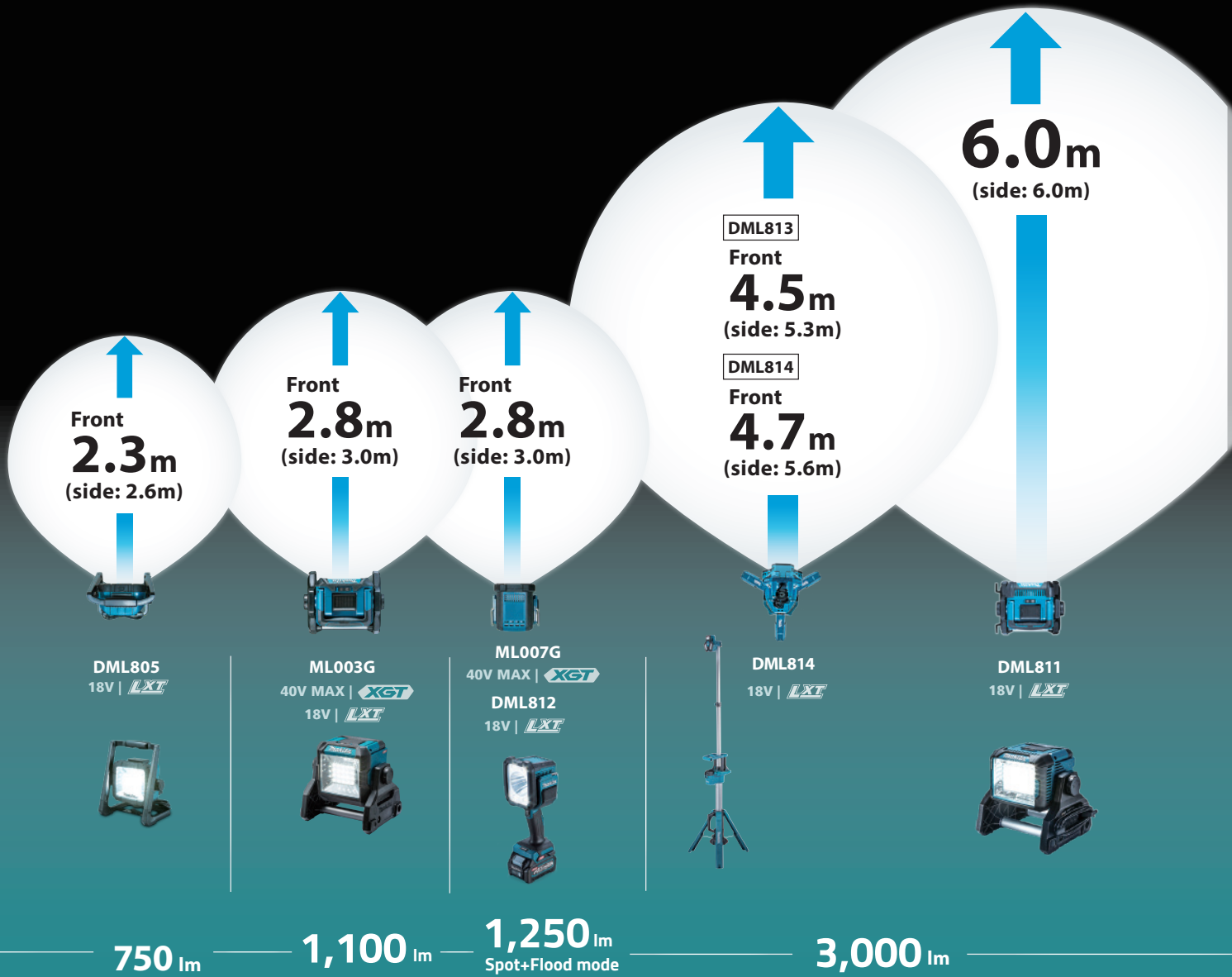

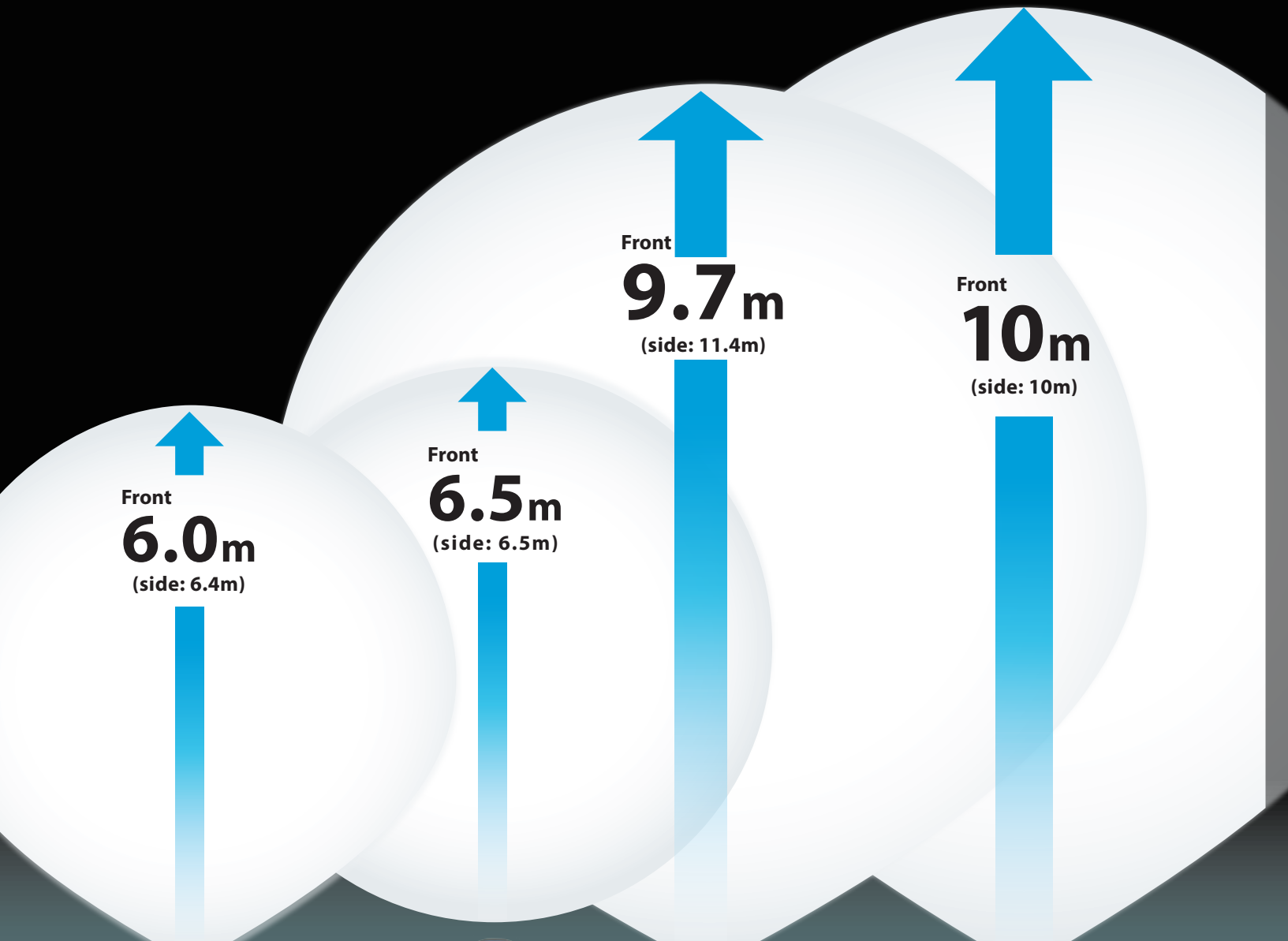
ML005G

40V MAX | **XGT**  
18V | **LXT**



3,600 lm



ML010G

40V MAX | **XGT**  
18V | **LXT**



5,000 lm



ML009G

40V MAX | **XGT**  
18V | **LXT**



10,000 lm



DML809

18V | **LXT**



- DRILLING / FIXING
- CONCRETE DRILLING / DEMOLITION
- MIXING / STIRRING
- CUTTING (CONCRETE / METAL)
- GRINDING
- SANDING / POLISHING
- SAWING
- MULTI-TOOL

### ML010G

40V MAX | XGT 18V | LXT

#### Cordless Area Worklight

**NEW**



Self-righting

**202 LED - Area Worklight (adapt upto 2 XGT or LXT batteries) and also operates using any 1 battery at a time**

- 3 brightness settings: 5,000 lumens on high mode
- Multi directional light (right, left & 360)

Runtime	<b>18 / 9.5 / 5.5 hrs</b>
	with BL4040 X 2
	Low / Medium / High



360° Right / Left 180°

- Up to 8.5 hours of continuous illumination on a full BL4050F (x2) charge at a constant illuminance on high mode
- 202 super luminous daylight white LEDs
- AC inlet and outlet allows to chain up to 8 lights together

<b>40V MAX</b>	<b>18V LITHIUM-ION</b>	<b>LXT</b>
----------------	------------------------	------------

<b>Illuminance (High / Med / Low)</b>	at 1m from the light source: 550 / 300 / 150 lx
<b>Luminous Flux</b>	High / Med / Low: 5,500 / 3,000 / 1,500 lm
<b>Dimensions (L x W x H)</b>	490 x 490 x 814 mm
<b>Net weight</b>	14.4 kg

AVAILABLE VARIANTS

**"Z" VARIANT**

**ML010G Z**  
TOOL ONLY  
(DOES NOT INCLUDE BATTERY / CHARGER OR CARRY CASE)

- ROUTERS / PLANERS
- NAILERS / STAPLERS
- HEAT GUN / LASER
- CLEANING
- OPE
- JOBSITE TOOLS
- SPECIALTY TOOLS
- HAND TOOLS / COMBINATION SET
- TOOL HOLDERS AND POUCHES / MAKPAC SYSTEM

### DML810

18V | LXT

#### Cordless Area Worklight



Self-righting

**202 LED - Area Worklight (adapt upto 2 batteries)**

- 3 brightness settings: 5,000 lumens on high mode
- Multi directional light (right, left & 360)

Runtime	<b>15 / 7 / 3.5 hrs</b>
	with BL1850B
	Low / Medium / High



360° Right / Left 180°

- Up to 4 hours of continuous illumination on a full BL1860B (x2) charge at a constant illuminance on high mode
- 202 super luminous daylight white LEDs
- AC inlet and outlet allows to chain up to 8 lights together

<b>18V LITHIUM-ION</b>	<b>LXT</b>
------------------------	------------

<b>Illuminance (High / Med / Low)</b>	at 1m from the light source: 550 / 300 / 150 lx
	at 3m from the light source: 90 / 50 / 25 lx
	at 5m from the light source: 50 / 25 / 10 lx
<b>Luminous Flux</b>	High / Med / Low: 5,500 / 3,000 / 1,500 lm
<b>Dimensions (L x W x H)</b>	420x420x787 mm
<b>Net weight</b>	15.3 kg

AVAILABLE VARIANTS

**"Z" VARIANT**

**DML810 Z**  
TOOL ONLY  
(DOES NOT INCLUDE BATTERY / CHARGER OR CARRY CASE)

### DML814

#### Cordless Area Worklight



Runtime

<b>10 / 5.5 / 3 hrs</b>
Low / Medium / High with BL1850B

**3 brightness settings: 3,000 lumens on high mode**

- Two lighting modes: Spot lighting / Area lighting
- Telescopic light mast enables lighting at a height up to 2.2m
- IP55 certified weather and dust resistance
- Highly stable tripod base, foldable into a compact size for simple storage and transport
- Shoulder belt attachable to the worklight or tool bag for comfortable carrying

<b>18V LITHIUM-ION</b>	<b>LXT</b>
------------------------	------------

<b>Run Time (hrs)</b>	w/ BL1850(B) Low / Mid / High: 10 / 5.5 / 3
<b>Illuminance (High / Mid / Low)</b>	at 1m from the light source: 1,250 / 750 / 400 lx
	at 3m from the light source: 130 / 80 / 40 lx
	at 5m from the light source: 50 / 30 / 15 lx
<b>Luminous Flux</b>	High / Mid / Low: 3,000 / 1,700 / 900 lm
<b>Dimensions (L x W x H)</b>	Folding Position: 260x216x1,000 mm
	Operating Position (Max Height): 573x658x1,250-2,240 mm
<b>Net weight</b>	7.9 kg

AVAILABLE VARIANTS

**"Z" VARIANT**

**DML814 Z**  
TOOL ONLY  
(DOES NOT INCLUDE BATTERY / CHARGER OR CARRY CASE)

The light head consists of 3 small light heads, and each of them can be pivoted independently for wide area lighting

LED color is daylight white, which is similar to the natural light (12 daylight white LEDs)

**Two lighting modes**  
Spot lighting / Area lighting

Pivoting range of light head for Spot lighting

right and left **115°**

up and down **110°**

Pivoting range of 3 small light heads for area lighting

up and down **90°**

The height of light head can be adjusted steplessly

**2,240 mm**

**1,250 mm**

**Easy installation and removal of battery**

The battery port is located at the middle height of the worklight so that the user need not bend down to access the battery

**Padlock hole for battery theft protection**

\*Padlock not included

**Three hook holes for the shoulder belt**

Two hook holes are located on the carrying handle beside the battery, and one on the end of a tripod leg

**Tripod fixing hole**

The tripod can be firmly secured to the ground with a screw or peg

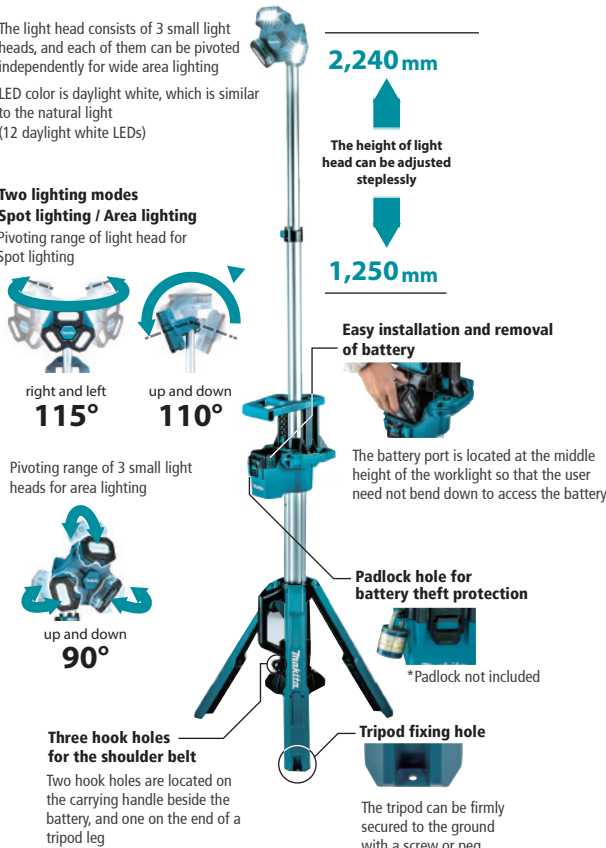



**ML009G** 40V MAX | XGT 18V | LXT

**Cordless Area Worklight**

Tripod 1 (Optional)  
 GM00002378 (for one light)

Vise (optional)  
 Part # GM00001396

Angle glare film (optional)  
 GM00002376

Lam shade (optional)  
 GM00002377



**Runtime**  
**14 / 6.5 / 2.4 hrs**  
Low / Medium / High with BL4040 x 2

**Two XGT battery terminals (Parallel) / Two LXT battery terminals (Parallel) or works with single XGT or LXT battery or with combination of XGT & LXT battery**

- 3-mode operation: delivers 10,000 lumens on high mode
- Battery capacity warning function
- IP65 certified Dust and Water resistance



<b>Illuminance (High / Mid / Low)</b>	at 1 m from the light source: 4,300 / 1,900 / 1,000 lx
<b>Luminous Flux</b>	High / Mid / Low: 10,000 / 4,000 / 2,000 lm
<b>Lighting Coverage</b>	Front / Sides: 9.7 / 11.4 m
<b>Dimensions (L x W x H)</b>	w/ Handle in Retracted Position: 248 x 386 x 305 mm w/ Handle in Upright Position: 248 x 386 x 430 mm
<b>Net weight</b>	6.1 kg (without battery)

**AVAILABLE VARIANTS**

**"Z" VARIANT**

**ML009G Z**  
TOOL ONLY  
(DOES NOT INCLUDE BATTERY / CHARGER OR CARRY CASE)

**ML005G** 40V MAX | XGT 18V | LXT

**Cordless Area Worklight**

Tripod 1 (Optional)  
 GM00002378 (Adapt one worklight)

Flat bar (Optional)  
 GM00002379 (Adapt two worklights)  
 (Tripod 1 is required to fix flat bar)

Tripod 2 (Optional)  
 GM00002073 (Adapt one or two worklights)  
 flat bar not required

Vise (optional)  
 Part # GM00001396

Angle glare film (optional)  
 GM00002359

Lamp shade (optional)  
 GM00002358



**Runtime**  
**15 / 7.5 / 3.5 hrs**  
Low / Medium / High with BL4040

**Works with single XGT or LXT battery**

- 3-mode operation: delivers 3,600 lumens on high mode
- Battery capacity warning function
- IP65 certified Dust and Water resistance



<b>Illuminance (High / Mid / Low)</b>	at 1m from the light source: 2,100 / 1,000 / 500 lx
<b>Luminous Flux</b>	High / Mid / Low: 3,600 / 1,800 / 900 lm
<b>Lighting Coverage</b>	High / Mid / Low: 3.5 / 7.5 / 15 h
<b>Dimensions (L x W x H)</b>	w/ Handle in Retracted Position: 248 x 309 x 296 mm w/ Handle in Upright Position: 248 x 309 x 423 mm
<b>Net weight</b>	4.6 kg

**AVAILABLE VARIANTS**

**"Z" VARIANT**

**ML005G ZX**  
TOOL WITH LAMP SHADE  
(DOES NOT INCLUDE BATTERY / CHARGER OR CARRY CASE)

**ML003G** 40V MAX | XGT 18V | LXT

**Cordless Area Worklight**

Tripod 1 (Optional)  
 GM00002378 (Adapt one worklight)

Flat bar (Optional)  
 GM00002379 (Adapt two worklights)  
 (Tripod 1 is required to fix flat bar)

Tripod 2 (Optional)  
 GM00002073 (Adapt one or two worklights)  
 flat bar not required

Vise (optional)  
 Part # GM00001396

Angle glare film (optional)  
 GM00002312



**Runtime**  
**22 / 10 hrs**  
Low / High with BL4040

**Works with single XGT or LXT battery**

- 2 Stage brightness setting controlled by single button switch with memory function
- Battery capacity warning function
- IP65 certified Dust and Water resistance



<b>Run Time (hrs)</b>	Up to: 22 (Low mode) and 10 (High mode)
<b>Type</b>	20 pcs x 0.6W
<b>Illuminance (High / Low)</b>	500 / 200 lx (at 1m from the light source) 1,900 / 800 lx (at 0.5m from the light source)
<b>Luminous Flux (High / Low)</b>	1,100 / 450 lm
<b>Dimensions (L x W x H)</b>	249x298x280mm (Handle in Retracted Position)
<b>Net weight</b>	3.4 kg (without battery)

**AVAILABLE VARIANTS**

**"Z" VARIANT**

**ML003G Z**  
TOOL ONLY  
(DOES NOT INCLUDE BATTERY / CHARGER OR CARRY CASE)

- DRILLING / FIXING
- CONCRETE DRILLING / DEMOLITION
- MIXING / STIRRING
- CUTTING (CONCRETE / METAL)
- GRINDING
- SANDING / POLISHING
- SAWING
- MULTI-TOOL
- ROUTERS / PLANERS
- NAILERS / STAPLERS
- HEAT GUN / LASER
- CLEANING
- OPE
- JOBSITE TOOLS
- SPECIALTY TOOLS
- HAND TOOLS / COMBINATION SET
- TOOL HOLDERS AND POUCHES / MAKPAC SYSTEM

- DRILLING / FIXING
- CONCRETE DRILLING / DEMOLITION
- MIXING / STIRRING
- CUTTING (CONCRETE / METAL)
- GRINDING
- SANDING / POLISHING
- SAWING
- MULTI-TOOL
- ROUTERS / PLANERS
- NAILERS / STAPLERS
- HEAT GUN / LASER
- CLEANING
- OPE
- JOBSITE TOOLS
- SPECIALTY TOOLS
- HAND TOOLS / COMBINATION SET
- TOOL HOLDERS AND POUCHES / MAKPAC SYSTEM

DML809
18V | **LXT**

Cordless Area Worklight

Tripod 1 (Optional)  
GM00002378 (Adapt one worklight)

Flat bar (Optional)  
GM00002379 (Adapt two worklights)  
(Tripod 1 is required to fix flat bar)

Tripod 2 (Optional)  
GM00002073 (Adapt one or two worklights)  
flat bar not required

Lamp shade (Optional)  
GM00002286

Runtime

7.5 / 3.5 / 1.4 hrs

Low / Medium / High with BL1850B x 2

**Adapt upto 2 LXT batteries (runs parallel)**

- 3-mode operation: delivers 10,000 lumens on high mode
- Up to 1.7 hours of continuous illumination with two 6.0Ah on high mode
- Dust and water-resistant construction (IP65 rated) for improved operation in harsh job site conditions
- L.E.D. lights effectively illuminate work area without the high heat of halogens

<b>18V LXT</b>	<b>Illuminance (High / Med / Low)</b>	3,800 / 1,500 / 800 lx 380 / 150 / 80 lx 150 / 60 / 30 lx
	<b>Luminous Flux</b>	10,000 / 4,000 / 2,000 lm
	<b>Dimensions (L x W x H)</b>	w/ Handle in Retracted Position: 249x370x278 mm w/ Handle in Upright Position: 249x370x370 mm
	<b>Net weight</b>	7.0 kg

AVAILABLE VARIANTS

"Z" VARIANT

**DML809 Z**  
TOOL ONLY  
(DOES NOT INCLUDE BATTERY / CHARGER OR CARRY CASE)

DML811
18V | **LXT**

Cordless Area Worklight

Tripod 1 (Optional)  
GM00002378 (Adapt one worklight)

Flat bar (Optional)  
GM00002379 (Adapt two worklights)  
(Tripod 1 is required to fix flat bar)

Tripod 2 (Optional)  
GM00002073 (Adapt one or two worklights)  
flat bar not required

Lamp shade (Optional)  
GM00002287

Runtime

13 / 7 / 3 hrs

Low / Medium / High with BL1850B

- 2 Stage brightness setting controlled by single button switch with memory function
- Battery capacity warning function
- IP65 certified Dust and Water resistance

<b>18V LXT</b>	<b>Illuminance (High / Med / Low)</b>	1,800 / 800 / 350 lx 200 / 100 / 40 lx 85 / 40 / 17 lx
	<b>Luminous Flux</b>	3,000 / 1,500 / 750 lm
	<b>Dimensions (L x W x H)</b>	w/ Handle in Retracted Position: 249x302x271 mm w/ Handle in Upright Position: 249x302x361 mm
	<b>Net weight</b>	4.8 kg

AVAILABLE VARIANTS

"Z" VARIANT

**DML811 Z**  
TOOL ONLY  
(DOES NOT INCLUDE BATTERY / CHARGER OR CARRY CASE)

DML805
18V | **LXT**

Cordless Area Worklight

Tripod (Optional)  
GM00002283

Vise (optional)  
Part # GM00001396

Runtime

17 / 8.5 hrs

Low / High with BL1850B

**20 LED - Area Worklight**

- 2-Mode operation: delivers 750 lumens on High mode
- Up to 17 hours of continuous illumination with a 5.0Ah battery on Low mode
- Extreme Protection Technology (XPT) is engineered for improved dust and water resistance for operation in harsh conditions (only with DC power)
- L.E.D. lights effectively illuminate work area without the high heat of halogens

<b>18V LXT</b>	<b>Illuminance (High / Med / Low)</b>	at 0.5m from the light source Hi: 1,150 lx, Lo: 750 lx at 1m from the light source Hi: 300 lx, Lo: 200 lx
	<b>Luminous Flux</b>	Hi: 750 lm, Lo: 450 lm
	<b>Dimensions (L x W x H)</b>	214x261x328mm
	<b>Net weight</b>	2.7 kg

AVAILABLE VARIANTS

"Z" VARIANT

**DML805 Z**  
TOOL ONLY  
(DOES NOT INCLUDE BATTERY / CHARGER OR CARRY CASE)





**ML002G** 40V MAX | XGT

**Cordless Flashlight / Lantern**



Shoulder hook set (optional)  
Part # GM00001028

**Runtime**  
**23 / 36 / 51 hrs**  
full / half mode / Flashlight with BL4040

**12 all around LED - Lantern**

- 3-stage brightness switch (Full Mode: 710lm | Half Mode : 340lm | Flashlight : 130lm)
- Up to 51 hours of continuous illumination with a 4.0Ah XGT battery on low mode
- Metal hang hook swivels 360°and folds away for added convenience
- Extreme Protection Technology is engineered to provide increased dust and water resistance in harsh job site conditions
- Built-in USB port for charging portable electronic devices (Type A, 5V, 2.4A)

**XGT 40V MAX**

<b>Run Time</b>	Up to: 51hrs (Flashlight mode)
<b>Luminous Flux</b>	Full mode: 710 lm / Half mode: 340 lm / Flashlight mode: 130lm
<b>Illuminance</b>	Full brightness: 340 lx / Half brightness: 310 lx / Flashlight mode: 1,900lx
<b>Dimensions (L x W x H)</b>	376 x 86 x 137 mm (with hook) (without battery)
<b>Net weight</b>	0.5 kg (without battery)

AVAILABLE VARIANTS

**"Z" VARIANT**

**ML002G Z**  
TOOL ONLY  
(DOES NOT INCLUDE BATTERY / CHARGER OR CARRY CASE)

**DML807** 18V | LXT

**Cordless Flashlight / Lantern**



Shoulder hook set (optional)  
Part # GM00001028

**Runtime**  
**14 / 28 / 43 hrs**  
full / half mode / Flashlight with BL1860B

**12 all around LED - Lantern**

- 3-stage brightness switch (Full Mode: 710lm | Half Mode : 340lm | Flashlight : 130lm)
- Up to 43 hours of continuous illumination with a 6.0Ah lxt battery on low mode
- Metal hang hook swivels 360°and folds away for added convenience
- Extreme Protection Technology is engineered to provide increased dust and water resistance in harsh job site conditions
- Built-in USB port for charging portable electronic devices (Type A, 5V, 2.4A)

**18V LXT**

<b>Run Time</b>	Up to: 43hrs (Flashlight mode)
<b>Luminous Flux</b>	Full mode: 710 lm / Half mode: 340 lm / Flashlight mode: 130lm
<b>Illuminance</b>	Full brightness: 340 lx / Half brightness: 310 lx / Flashlight mode: 1,900lx
<b>Dimensions (L x W x H)</b>	361 x 79 x 155 mm (with hook) (without battery)
<b>Net weight</b>	0.32 kg (without battery)

AVAILABLE VARIANTS

**"Z" VARIANT**

**DML807 Z**  
TOOL ONLY  
(DOES NOT INCLUDE BATTERY / CHARGER OR CARRY CASE)

**ML006G** 40V MAX | XGT

**Cordless Flashlight**



Can be used as a compact stationary lamp with the light head swivelled and folded fully

**Rotatable and foldable light head, Max luminous flux: 500 lm**

- Light diffusing lens softens the light of LED to reduce glare and also provides widespread illumination.
- Battery capacity warning by LED lights

**Runtime**  
**82 / 40 / 20 hrs**  
Low / Medium / High with BL4040

**XGT 40V MAX**

**Specification:-**

<b>Illuminance (at 0.5m from the light source)</b>	High/ Medium/ Low: 800 / 400 /180 lx
<b>Luminous Flux</b>	High/ Medium/ Low: 500 / 250 / 100 lm
<b>Dimensions (L x W x H)</b>	109 x 79 x 354 -221mm
<b>Net weight</b>	0.42 kg (without battery)

AVAILABLE VARIANTS

**"Z" VARIANT**

**ML006G Z**  
TOOL ONLY  
(DOES NOT INCLUDE BATTERY / CHARGER OR CARRY CASE)

**DML816** 18V | LXT

**Cordless Flashlight**



Can be used as a compact stationary lamp with the light head swivelled and folded fully

**Rotatable and foldable light head, Max luminous flux: 500 lm**

- Light diffusing lens softens the light of LED to reduce glare and also provides widespread illumination.
- Battery capacity warning by LED lights

**Runtime**  
**75 / 34 / 17 hrs**  
Low / Medium / High with BL1860B

**18V LXT**

<b>Illuminance (at 0.5m from the light source)</b>	High/ Medium/ Low: 800 / 400 /180 lx
<b>Luminous Flux</b>	High/ Medium/ Low: 500 / 250 / 100 lm
<b>Dimensions (L x W x H)</b>	109 x 79 x 354 -221mm
<b>Net weight</b>	0.42 kg (without battery)

AVAILABLE VARIANTS

**"Z" VARIANT**

**DML816 Z**  
TOOL ONLY  
(DOES NOT INCLUDE BATTERY / CHARGER OR CARRY CASE)

- DRILLING / FIXING
- CONCRETE DRILLING / DEMOLITION
- MIXING / STIRRING
- CUTTING (CONCRETE / METAL)
- GRINDING
- SANDING / POLISHING
- SAWING
- MULTI-TOOL
- ROUTERS / PLANERS
- NAILERS / STAPLERS
- HEAT GUN / LASER
- CLEANING
- OPE
- JOBSITE TOOLS
- SPECIALTY TOOLS
- HAND TOOLS / COMBINATION SET
- TOOL HOLDERS AND POUCHES / MAKPAC SYSTEM

DRILLING / FIXING
CONCRETE DRILLING / DEMOLITION
MIXING / STIRRING
CUTTING (CONCRETE / METAL)
GRINDING
SANDING / POLISHING
SAWING
MULTI-TOOL
ROUTERS / PLANERS
NAILERS / STAPLERS
HEAT GUN / LASER
CLEANING
OPE
JOBSITE TOOLS
SPECIALTY TOOLS
HAND TOOLS / COMBINATION SET
TOOL HOLDERS AND POUCHES / MAKPAC SYSTEM

ML007G
40V MAX | XGT

**Cordless Flashlight**



Shoulder hook set (optional)  
Part # GM00002239

**Runtime**

22 / 16 / 22 / 22 hrs

Spot / Flood / Spot-Flood / Strobe: with BL4080F

**Over 640m Beam Distance & Max 1,250 Lumens flashlight**

- 4-Mode operation: spot | flood | spot+flood | strobe
- Compact and ergonomic design provides increased comfort on the job
- Extreme Protection Technology (XPT) is engineered for improved dust and water resistance for operation in harsh conditions
- 90° pivoting head for user convenience
- Battery capacity warning function



at 1m from the light source	
<b>Illuminance</b>	Spot / Flood / Spot-Flood: 82,000 / 520 / 60,000 lx
<b>Luminous Flux</b>	Spot / Flood / Spot-Flood: 600 / 1,000 / 1,250 lm
<b>Continuous run time (hours)</b>	Spot, Flood or Strobe mode : 2.0Ah : 5.5hrs   4.0Ah: 10hrs 5.0Ah :14hrs   8.0Ah: 22hrs
	Spot-Flood mode : 2.0Ah : 3.5hrs   4.0Ah: 7.5hrs 5.0Ah :10hrs   8.0Ah: 16hrs
<b>Dimensions (L x W x H)</b>	106 x 120 273 mm
<b>Net weight</b>	0.95 kg (without battery)

**AVAILABLE VARIANTS**

**"Z" VARIANT**

**ML007G Z**  
TOOL ONLY  
(DOES NOT INCLUDE BATTERY / CHARGER OR CARRY CASE)

DML812
18V | LXT

**Cordless Flashlight**



Shoulder hook set (optional)  
Part # GM00002239

**Runtime**

10 / 7.3 / 6 / 8.5 hrs

Spot / Flood / Spot-Flood / Strobe: with BL1860B

**Over 640m Beam Distance & Max 1,250 Lumens flashlight**

- 4-Mode operation: spot | flood | spot+flood | strobe
- Compact and ergonomic design provides increased comfort on the job
- Extreme Protection Technology (XPT) is engineered for improved dust and water resistance for operation in harsh conditions
- 90° pivoting head for user convenience



at 0.5m from the light source	
<b>Luminous Flux</b>	Spot / Flood: 71,000 / 520 lx
	Spot / Flood / Spot-Flood: 600 / 1,000 / 1,250 lm
<b>Continuous run time (hours)</b>	Spot : 5.0Ah : 8.5hrs   6.0Ah: 10hrs Flood : 5.0Ah : 6.5hrs   6.0Ah: 7.3hrs
	Spot-Flood mode : 5.0Ah : 5hrs   6.0Ah: 6hrs Strobe 5.0Ah :7hrs   6.0Ah: 8.5hrs
<b>Dimensions (L x W x H)</b>	106 X 119 X 273 mm
<b>Net weight</b>	0.95 kg (without battery)

**AVAILABLE VARIANTS**

**"Z" VARIANT**

**DML812 Z**  
TOOL ONLY  
(DOES NOT INCLUDE BATTERY / CHARGER OR CARRY CASE)

ML001G
40V MAX | XGT

**Cordless Flashlight**



Strap with Hook (standard)  
Part # GM00002280

**Runtime**

55 hrs

with BL4040

**High-luminance 4 x 0.5 W LED flashlight provides 160 lumens**

- Bright illumination, Compact and Lightweight
- Up to 55 Hours of Illumination with 40v max XGT 4.0Ah Battery
- Compact and ergonomic design provides increased comfort on the job
- Pivoting head with 12 different positions
- Ergonomically designed handle with rubberized soft grip
- Metal hang hook is convenient and job site durable



<b>Luminous Flux</b>	160 lm
<b>Illuminance</b>	at 1m from the light source: 3,000 lx
<b>Dimensions (L x W x H)</b>	232 x 88 x 92 mm
<b>Net weight</b>	0.3kg (without battery)

**AVAILABLE VARIANTS**

**"Z" VARIANT**

**ML001G Z**  
TOOL ONLY  
(DOES NOT INCLUDE BATTERY / CHARGER OR CARRY CASE)

DML815
18V | LXT

**Cordless Flashlight**



Strap with Hook (standard)  
Part # GM00001289

**Runtime**

45 hrs

with BL1850B

**High-luminance 4 x 0.5 W LED flashlight provides 160 lumens**

- Multi directional light (right, left & 360)
- Up to 54 Hours of illumination with 18V LXT 6.0Ah Battery
- 12 position pivoting flashlight head with positive stops from 0° - 170°
- LED provides a sharp, round spotlight



<b>Luminous Flux</b>	160 lm
<b>Illuminance</b>	at 1m from the light source: 3,000 lx
<b>Dimensions (L x W x H)</b>	272x79x116 mm
<b>Net weight</b>	0.26 kg (without battery)

**AVAILABLE VARIANTS**

**"Z" VARIANT**

**DML815 Z**  
TOOL ONLY  
(DOES NOT INCLUDE BATTERY / CHARGER OR CARRY CASE)

**ML106** 12V MAX | **CXT**

**Cordless LED Flashlight**



**Runtime**  
**12 hrs**  
with BL1041B

**High-luminance single LED flashlight provides 190 lumens**

- Zoom function adjusts illumination range
- 4.9 W high-luminance single LED
- Up to 12 hours of illumination with BL1041B



<b>Run Time (hrs)</b>	Up to: 12
<b>Luminous flux</b>	190 lm
<b>Illuminance</b>	at 1m from the light source 170 - 4,500 lx
<b>Dimensions (L x W x H)</b>	271x66x93 mm
<b>Net weight</b>	0.78 kg (with BL1041B)

**Standard Equipment:** Strap Hook

AVAILABLE VARIANTS

**"Z" VARIANT**

**ML106 Z**  
TOOL ONLY  
(DOES NOT INCLUDE BATTERY / CHARGER OR CARRY CASE)

**ML011G** 40V MAX | **XGT**

**Cordless Worklight**



**Runtime**  
**37 hrs**  
with BL4040 @300 lm

**Compact size fits your hand perfectly**

- Lightweight for reduced operator fatigue
- Ergonomic design easy to grip either from the top or the side
- Soft grip provides increased comfort
- 300lm Max luminous flux
- USB output port for charging mobile device
- Supplied with Warm white lamp shade

Three lighting modes Sidelighting + Uplighting | Sidelighting | Uplighting



**Illuminance (at 0.5 m)** Sidelighting + Uplighting / Sidelighting only / Uplighting only: 240 / 190 / 190 lx  
**Luminous flux** Sidelighting + Uplighting / Sidelighting only / Uplighting only: 300 / 150 / 150 lm  
**Run time (hrs)** with 4.0Ah @ 300 lm: 37 | with 4.0Ah @ 150 lm: 64  
**Dimensions (L x W x H)** 107 x 77 x 50 mm  
**Net weight** 0.19 kg



AVAILABLE VARIANTS

**"Z" VARIANT**

**ML011G Z**  
TOOL ONLY  
(DOES NOT INCLUDE BATTERY / CHARGER OR CARRY CASE)

**DML817** 18V | **LXT**

**Cordless Worklight**



**Runtime**  
**28 hrs**  
with BL1860B @300 lm

**Compact size fits your hand perfectly**

- Lightweight for reduced operator fatigue
- Ergonomic design easy to grip either from the top or the side
- Soft grip provides increased comfort
- 300lm Max luminous flux
- USB output port for charging mobile device
- Supplied with Warm white lamp shade

Three lighting modes Sidelighting + Uplighting | Sidelighting | Uplighting



<b>Illuminance (at 0.5 m)</b>	Sidelighting + Uplighting / Sidelighting only / Uplighting only: 240 / 190 / 190 lx
<b>Luminous flux</b>	Sidelighting + Uplighting / Sidelighting only / Uplighting only: 300 / 150 / 150 lm
<b>Run time (hrs)</b>	with 4.0Ah @ 300 lm: 28   with 4.0Ah @ 150 lm: 49
<b>Dimensions (L x W x H)</b>	107 x 77 x 50 mm
<b>Net weight</b>	0.21 kg

AVAILABLE VARIANTS

**"Z" VARIANT**

**DML817 Z**  
TOOL ONLY  
(DOES NOT INCLUDE BATTERY / CHARGER OR CARRY CASE)

**ML103** 12V MAX | **CXT**

**Cordless LED Flashlight**



**Runtime**  
**28 hrs**  
with BL1041B

**Compact size fits your hand perfectly**

- Lightweight for reduced operator fatigue
- Ergonomic design easy to grip either from the top or the side
- Soft grip provides increased comfort
- 1.5W white single diffusion LED provides bright and wide illumination



<b>Dimensions (L x W x H)</b>	77x54x28 mm (without Battery)
<b>Net weight</b>	87x64x54 mm (with BL1021B) 87x64x73 mm (with BL1041B) 0.27 kg (with BL1021B) / 0.43 kg (with BL1041B)

AVAILABLE VARIANTS

**"Z" VARIANT**

**ML103 Z**  
TOOL ONLY  
(DOES NOT INCLUDE BATTERY / CHARGER OR CARRY CASE)

- DRILLING / FIXING
- CONCRETE DRILLING / DEMOLITION
- MIXING / STIRRING
- CUTTING (CONCRETE / METAL)
- GRINDING
- SANDING / POLISHING
- SAWING
- MULTI-TOOL
- ROUTERS / PLANERS
- NAILERS / STAPLERS
- HEAT GUN / LASER
- CLEANING
- OPE
- JOBSITE TOOLS
- SPECIALTY TOOLS
- HAND TOOLS / COMBINATION SET
- TOOL HOLDERS AND POUCHES / MAKPAC SYSTEM

- DRILLING / FIXING
- CONCRETE DRILLING / DEMOLITION
- MIXING / STIRRING
- CUTTING (CONCRETE / METAL)
- GRINDING
- SANDING / POLISHING
- SAWING
- MULTI-TOOL

**DMR055**
18V | **LXT**

Cordless Radio with Lantern



**NEW**

Strap with hook (optional)  
SE00001178



**Offers unparalleled flexibility, serving as an ideal solution for your lighting and audio needs**

**Radio Features:**

- Delivers premium sound quality with 57 mm dia speakers
- LCD display allows for easy mode selection and with digital tune and up to 9 station pre-sets

**Lantern Features:**

- The Lantern can be held sideways with a strap hook or placed normally like a lantern
- Lantern with full 360° coverage (4 sides) (130lx (260lm)
- Lantern with 270° coverage (3 sides) (115lx (190lm)
- The colour tone of the light is warm white

**Continuous run time with optional 6.0Ah Battery (BL1860B)**

- Both Radio and Lantern can work at the same time
- The continuous runtime is 19hours with Lantern (360° mode) and 63hours with radio only option
- Runtime up to 14hours running both radio and lantern

**Frequency Band** FM: 87.5-108 MHz / AM: 522-1,710 kHz

**Speaker Size** Ø57 mm

**Illuminance** Lantern, Warm white, 4 sides, High: 130 or more lx

**Luminous flux** Lantern, Warm white, 4 sides, High: 260 or more

**Dimensions (L x W x H)** 126 x 127 x 240 mm (without battery)

**Net weight** 0.95 kg (without battery)

AVAILABLE VARIANTS

"Z" VARIANT

DMR055 Z

- ROUTERS / PLANERS
- NAILERS / STAPLERS
- HEAT GUN / LASER
- CLEANING
- OPE
- JOBSITE TOOLS
- SPECIALTY TOOLS
- HAND TOOLS / COMBINATION SET
- TOOL HOLDERS AND POUCHES / MAKPAC SYSTEM

**MR006G**
40V MAX | **XGT** 18V | **LXT** 12V MAX | **CXT** 

Cordless Bluetooth Radio



**Compatible with Makita 40V MAX XGT / 18V LXT / 12V CXT Batteries or AC Power**

- Equipped with Bluetooth 5.0 to wirelessly connect your mobile device to play music
- 2 Side firing speakers deliver stereo sound and a dedicated bottom firing subwoofer for deep and rich audio quality
- 7 pre-set equalizer modes with LED colour indication to optimize sound output
- Dust and water-resistant construction (IP65 rated)
- Adjustable sleep timer with auto shut off feature and alarm function
- AUX-IN port for connecting to an external audio source
- USB port enables convenient charging of mobile devices on the jobsite

<b>Speaker Size</b>	Sides: Ø63.5 mm x2 / Bottom: Ø101.6 mm
<b>Max Output</b>	40V max / 18V / 12V max / AC
<b>Run time (approx)</b>	w/ BL4040: 19 hrs
<b>Bluetooth</b>	Yes
<b>Frequency Band</b>	FM / AM: 87.5 - 108 MHz / 522 - 1,710 kHz
<b>Dimensions (L x W x H)</b>	285 x 172 x 441 mm
<b>Net weight</b>	4.3 kg (without battery)

Standard Equipment: AC Adapter

AVAILABLE VARIANTS

"Z" VARIANT

MR006G Z  
(DOES NOT INCLUDE BATTERY / CHARGER OR CARRY CASE)

**MR001G**
40V MAX | **XGT** 18V | **LXT** 12V MAX | **CXT** 

Cordless Radio



**NEW**

**Powered by 40V MAX XGT / 18V LXT AND 12V MAX CXT and AC adapter or AA batteries for backup**

- AUX-IN port for connecting to an external audio source
- Carry handle with built-in FM antenna
- Large ø89mm speaker
- Dust and water-resistant construction (IP65 rated)
- 36 hrs with 4.0Ah XGT Battery

<b>Speaker Size</b>	FM / AM: 87.5 - 108 MHz / 522 - 1,710 kHz
<b>Max Output</b>	Woofer: Dia. 89 mm x2
<b>Run time (approx)</b>	40Vmax: 5 W x2
<b>Bluetooth</b>	Supported Codec: SBC
<b>Frequency Band</b>	with Handle in Upright Position:
<b>Dimensions (L x W x H)</b>	280 x 171 x 434 mm
<b>Net weight</b>	4.3 kg (without battery)

Standard Equipment: AC Adapter

AVAILABLE VARIANTS

"Z" VARIANT

MR001G Z  
(DOES NOT INCLUDE BATTERY / CHARGER OR CARRY CASE)

**DMR300** 18V | LXT 12V MAX | CXT 

**Cordless Bluetooth Radio**



**Compatible with Makita 18V LXT / 12V CXT Batteries or AC Power**

- Equipped with Bluetooth 5.0 to wirelessly connect your mobile device to play music
- 2 powerful side firing speakers deliver rich stereo sound
- Built-in bottle opener for job site convenience
- Dust and water-resistant construction (IP65 rated)
- Adjustable sleep timer with auto shut off feature and alarm function
- USB port enables convenient charging of mobile devices on the jobsite
- Features one auxiliary port for MP3 compatibility



<b>Speaker Size</b>	Dia. 89 mm x2
<b>Max Output</b>	18V / 12V max / AC
<b>Run time (approx)</b>	w/ BL1850B: 20.5 hrs
<b>Bluetooth</b>	Yes
<b>Frequency Band</b>	FM / AM: 87.5 - 108 MHz / 522 - 1,710 kHz
<b>Dimensions (L x W x H)</b>	268x185x427 mm
<b>Net weight</b>	5.2 kg

**Standard Equipment:** AC Adapter

AVAILABLE VARIANTS

**"Z" VARIANT**

**DMR300 Z**  
(DOES NOT INCLUDE BATTERY / CHARGER OR CARRY CASE)

**MR052**

**Cordless Radio**



**Compact design radio for High portability**

- Rubber rod antenna. (AM built in) No need to extend.
- AUX-IN JACK allows for connection to personal audio players.
- LCD digital display for better view even in dark area.
- Earphone Jack can connect with headphones
- Rotating rafter hook convenient to hang the radio on scaffolding pipe, etc



<b>Frequency Band</b>	FM / AM: 87.5 - 108 MHz / 522 - 1,710 kHz
<b>Run time (approx)</b>	with BL1041B: 30hrs with BL1021B: 15hrs
<b>Dimensions (L x W x H)</b>	169x73x74 mm
<b>Net weight</b>	0.72 kg

AVAILABLE VARIANTS

**"Z" VARIANT**

**MR052 Z**  
(DOES NOT INCLUDE LI-ION BATTERY / CHARGER OR CARRY CASE)

**DMR116** 18V | LXT G-SERIES 

**Cordless Radio**



**Compatible with LXT, G-Series battery and AC power adapter**

- AUX-IN port for connecting to an external audio source
- Carry handle with built-in FM antenna
- Large ø76mm speaker
- Dust and water-resistant construction (IP64 rated)
- 37 hrs with 6.0Ah LXT Battery



<b>Frequency Band</b>	FM / AM: 87.5 - 108 MHz / 522 - 1,710 kHz
<b>Speaker Size</b>	Dia.: Ø76 mm x2
<b>Max Output</b>	18V: 3.5 W x2
<b>Dimensions (L x W x H)</b>	with Handle in Upright Position: 257 x 163 x 431 mm
<b>Net Weight</b>	4.1kg (without battery)

**Standard Equipment:** AC Adapter

AVAILABLE VARIANTS

**"Z" VARIANT**

**DMR116 Z**  
(DOES NOT INCLUDE BATTERY / CHARGER OR CARRY CASE)

**DMR200** 18V | LXT 12V MAX | CXT 

**Cordless Bluetooth Speaker**



**Powerful & Deep Stereo Sound with Bluetooth and AUX-IN jack**

- Highly durable housing design with an IP64 rating against dust and water
- 101mm woofer and 36mm tweeter deliver 10W\* of high quality radio
- Powered by either 18V, 12V or AC Power
- Max. 30m, Optimum 10m



<b>Speaker Size</b>	Woofer/Tweeter: Ø101.6 / Ø36 mm
<b>Max Output</b>	18V / 12Vmax / AC : 10 / 3.5 / 3.5 W
<b>Run time (approx)</b>	w/ BL1850B: 26 hrs
<b>Bluetooth</b>	Version: 4.0 Max Transmission Range (Optimum): 10 m (33 ft) Max Transmission Range (Possible): 30 m (100 ft)
<b>Dimensions (L x W x H)</b>	w/ Handle in Retracted Position: 211x203x199 mm
<b>Net weight</b>	2.72 kg

AVAILABLE VARIANTS

**"Z" VARIANT**

**DMR200 Z**  
(DOES NOT INCLUDE BATTERY / CHARGER OR CARRY CASE)

- DRILLING / FIXING
- CONCRETE DRILLING / DEMOLITION
- MIXING / STIRRING
- CUTTING (CONCRETE / METAL)
- GRINDING
- SANDING / POLISHING
- SAWING
- MULTI-TOOL
- ROUTERS / PLANERS
- NAILERS / STAPLERS
- HEAT GUN / LASER
- CLEANING
- OPE
- JOBSITE TOOLS
- SPECIALTY TOOLS
- HAND TOOLS / COMBINATION SET
- TOOL HOLDERS AND POUCHES / MAKPAC SYSTEM

DRILLING /  
FIXING

CONCRETE  
DRILLING /  
DEMOLITION

MIXING /  
STIRRING

CUTTING  
(CONCRETE /  
METAL)

GRINDING

SANDING /  
POLISHING

SAWING

MULTI-TOOL

ROUTERS /  
PLANERS

NAILERS /  
STAPLERS

HEAT GUN /  
LASER

CLEANING

OPE

JOBSITE  
TOOLS

SPECIALTY  
TOOLS

HAND TOOLS /  
COMBINATION SET

TOOL HOLDERS  
AND POUCHES /  
MAKPAC SYSTEM

## CORDLESS FAN



### CF003G - 450mm

40V MAX | XGT 18V | LXT

#### Cordless Fan



#### Multiple power sources; 40V MAX XGT / 18V LXT / AC adapter

- 450 mm large fan produces Max air flow volume: 120m<sup>3</sup>/min
- Three oscillation angles are specified, allowing air to be supplied at a desired angle
- Dial-style air flow volume adjustment (38 - 120m<sup>3</sup>/min)
- Can be mounted onto MAKPAC cart
- 3-stage automatic timer with 1, 2, and 4 hour power-off selection
- Fan tilts up and down



Continuous Use (min.) w/o oscillation	with XGT 8.0Ah: 230 mins with LXT 6.0Ah: 90 mins
Max Air Velocity	300-96 m/min
Air Flow	120-38 m <sup>3</sup> /min
Fan Diameter	450mm
Noise Level	55 dB(A)
Dimensions (L x W x H)	312 x 633 x 770 mm
Net weight	7.9 kg (without battery)

Standard Equipment: AC adapter

#### AVAILABLE VARIANTS

#### "Z" VARIANT

**CF003G Z**  
TOOL ONLY  
(DOES NOT INCLUDE BATTERY / CHARGER OR CARRY CASE)

### CF002G - 330mm

40V MAX | XGT

#### Cordless Fan



#### Dual power sources; 40V MAX XGT batteries or AC adapter

- 330 mm large fan produces strong enough air to create a comfortable work environment
- Automatically oscillates 45° right and left
- 3 selectable wind speeds: High / Medium / Low
- 3-stage automatic timer with 1, 2, and 4 hour power-off selection
- Fan tilts up and down control



Continuous Use (min.) w/o oscillation	w/ BL4040 Low / Mid / High: 1,020 / 640 / 320
Continuous Use (min.) w/ oscillation	w/ BL4040 Low / Mid / High: 970 / 610 / 305
Max Air Velocity	High / Mid / Low: 240 / 170 / 120 m/min
Air Flow	High / Mid / Low: 21 / 15 / 10 m <sup>3</sup> /min
Fan Diameter	330 mm (13")
Noise Level	52 dB(A)
Dimensions (L x W x H)	w/ BL4040: 277 x 439 x 602 mm
Net weight	3.8 kg (without battery)

Standard Equipment: AC adapter

#### AVAILABLE VARIANTS

#### "Z" VARIANT

**CF002G Z**  
TOOL ONLY  
(DOES NOT INCLUDE BATTERY / CHARGER OR CARRY CASE)



**CF001G - 235mm** 40V MAX | XGT 

**Cordless Fan**



**Dual power sources; 40V MAX XGT batteries or AC adapter**

- 235 mm large fan produces strong enough air to create a comfortable work environment
- Automatically oscillates 45° right and left
- 3 selectable wind speeds: High / Medium / Low
- 3-stage automatic timer with 1, 2, and 4 hour power-off selection
- Fan tilts up and down

 	
<b>Continuous Use (min.) w/o oscillation</b>	w/ BL4040 Low / Mid / High: 1,160 / 880 / 660
<b>Continuous Use (min.) w/ oscillation</b>	w/ BL4040 Low / Mid / High: 1,055 / 800 / 600
<b>Max Air Velocity</b>	High / Mid / Low: 190 / 150 / 120 m/min
<b>Air Flow</b>	High / Mid / Low: 8.2 / 6.5 / 5.2 m³/min
<b>Fan Diameter</b>	235 mm
<b>Noise Level</b>	48 dB(A) (w/ high speed)
<b>Dimensions (L x W x H)</b>	143x333x463 mm
<b>Net weight</b>	2.0 kg (without battery)

**Standard Equipment:** AC adapter

AVAILABLE VARIANTS

**"Z" VARIANT**

**CF001G Z**  
TOOL ONLY  
(DOES NOT INCLUDE BATTERY / CHARGER OR CARRY CASE)



**DCF301 - 330mm** 18V | LXT 

**Cordless Fan**



**Dual power sources; 18V LXT batteries or AC adapter**

- 330 mm large fan produces strong enough air to create a comfortable work environment
- Automatically oscillates 45° right and left
- 3 selectable wind speeds: High / Medium / Low
- 3-stage automatic timer with 1, 2, and 4 hour power-off selection
- Fan tilts up and down control

 	
<b>Continuous Use (min.) w/o oscillation</b>	w/ BL1860B Low / Mid / High: 850 / 430 / 215
<b>Continuous Use (min.) w/ oscillation</b>	w/ BL1860B Low / Mid / High: 815 / 415 / 210
<b>Max Air Velocity</b>	High / Mid / Low: 240 / 170 / 120 m/min
<b>Air Flow</b>	High / Mid / Low: 21 / 15 / 10 m³/min
<b>Fan Diameter</b>	330 mm (13")
<b>Noise Level</b>	52 dB(A)
<b>Dimensions (L x W x H)</b>	w/ BL1860B: 269 x 439 x 602 mm
<b>Net weight</b>	3.8 kg (without battery)

**Standard Equipment:** AC adapter



AVAILABLE VARIANTS

**"Z" VARIANT**

**DCF301 Z**  
TOOL ONLY  
(DOES NOT INCLUDE BATTERY / CHARGER OR CARRY CASE)



**CF101D - 180mm** 12V MAX | CXT 

**Cordless Fan**

**Dual power sources; 12V LXT batteries or AC adapter**

- 148mm Compact size fan and can be mounted on tripods
- Automatically Swings 45° L/R (only for CF101D)
- 3 selectable wind speeds: High / Medium / Low
- 3-stage automatic timer with 1, 2, and 4 hour power-off selection
- Adjustable hook on the handle allows the fan to hang on a pole and etc
- Fan tilts up and down control

 	
<b>Continuous use (approx.) (min.)</b>	Low / Medium / High: 630 / 380 / 275 (with BL1041B) Low / Medium / High: 315 / 190 / 135 (with BL1021B)
<b>Max air flow: m /min</b>	High / Med / Low: 4.6 / 3.8 / 3.0 L/min
<b>Fan Diameter</b>	180 mm
<b>Dimensions (L x W x H)</b>	185 x 260 x 284mm
<b>Net weight</b>	1.3 kg (without battery)

**Standard Equipment:** AC adapter

AVAILABLE VARIANTS

**"Z" VARIANT**

**CF101D Z**  
TOOL ONLY  
(DOES NOT INCLUDE BATTERY / CHARGER OR CARRY CASE)

**CF100D - 180mm** 12V MAX | CXT 

**Cordless Fan**



**Dual power sources; 12V LXT batteries or AC adapter**

- 148mm Compact size fan and can be mounted on tripods
- 3 selectable wind speeds: High / Medium / Low
- 3-stage automatic timer with 1, 2, and 4 hour power-off selection
- Adjustable hook on the handle allows the fan to hang on a pole and etc
- Fan tilts up and down control

 	
<b>Continuous use (approx.) (min.)</b>	Low / Medium / High: 630 / 380 / 275 (with BL1041B) Low / Medium / High: 315 / 190 / 135 (with BL1021B)
<b>Max air flow: m /min</b>	High / Med / Low: 4.6 / 3.8 / 3.0 L/min
<b>Fan Diameter</b>	180 mm
<b>Dimensions (L x W x H)</b>	148x260x252 mm
<b>Net weight</b>	0.9 kg (without battery)

**Standard Equipment:** AC adapter

AVAILABLE VARIANTS

**"Z" VARIANT**

**CF100D Z**  
TOOL ONLY  
(DOES NOT INCLUDE BATTERY / CHARGER OR CARRY CASE)

- DRILLING / FIXING
- CONCRETE DRILLING / DEMOLITION
- MIXING / STIRRING
- CUTTING (CONCRETE / METAL)
- GRINDING
- SANDING / POLISHING
- SAWING
- MULTI-TOOL
- ROUTERS / PLANERS
- NAILERS / STAPLERS
- HEAT GUN / LASER
- CLEANING
- OPE
- JOBSITE TOOLS
- SPECIALTY TOOLS
- HAND TOOLS / COMBINATION SET
- TOOL HOLDERS AND POUCHES / MAKPAC SYSTEM

ADAPTER FOR CHARGING ELECTRONIC DEVICES



DRILLING / FIXING

CONCRETE DRILLING / DEMOLITION

MIXING / STIRRING

CUTTING (CONCRETE / METAL)

GRINDING

SANDING / POLISHING

SAWING

MULTI-TOOL

ROUTERS / PLANERS

NAILERS / STAPLERS

HEAT GUN / LASER

CLEANING

OPE

JOBSITE TOOLS

SPECIALTY TOOLS

HAND TOOLS / COMBINATION SET

TOOL HOLDERS AND POUCHES / MAKPAC SYSTEM

ADP001G

40V MAX | XGT

Adapter



**Charges mobile devices (smartphones, tablets)**

- Adapter is designed to be attached with XGT batteries and can charge USB compatible devices such as smartphones, tablets, etc.
- 2 USB output ports: Enable to charge two devices at the same time
- Over discharge protection circuit
- Push button type ON-OFF switch enables on/off control of USB output.
- With auto-off function (LED indicator is on in green while the switch is on)
- Built-in strap hole attaches to a belt or holster
- Compatible with iOS and Android devices



USB port	2
Max output current A	one port: 2.4   two ports: 4.8
Dimensions (L x W x H)	96 x 76 x 40 mm
Net weight	0.14 kg

AVAILABLE VARIANTS

"Z" VARIANT

**ADP001 Z**  
ADAPTER ONLY (DOES NOT INCLUDE BATTERY / CHARGER)

ADP05

18V | LXT

Adapter



**Charges mobile devices (smartphones, tablets)**

- Adapter is designed to be attached with LXT batteries and can charge USB compatible devices such as smartphones, tablets, etc.
  - 2 USB output ports: Enable to charge two devices at the same time
  - Over discharge protection circuit
  - Built-in strap hole attaches to a belt or holster
- Compatible with iOS and Android devices



Voltage	18V / 14.4V Li-ion (LXT)
USB port	2
Max output current A	One port: 2.1 / Two port 4.2
Dimensions	102x72x43mm
Net weight	0.11Kg

AVAILABLE VARIANTS

"Z" VARIANT

**ADP05 Z**  
ADAPTER ONLY (DOES NOT INCLUDE BATTERY / CHARGER)



**ADP08** 12V MAX | CXT



**Adapter**

NEW



**Charges mobile devices (smartphones, tablets)**

- Compact version of ADP06 (ADP06 comes with hook on top of the body)
- Adapter is designed to attached with CXT batteries and can charge USB compatible device such as Smartphone, Tablet, etc
- Over discharge protection circuit
- Built-in strap hole attaches to a belt or holster
- Compatible with IOS and Android devices

<b>Voltage</b>	12V MAX Li-ion (CXT)
<b>USB port</b>	1
<b>Max output current A</b>	2.1
<b>Dimensions</b>	80x53x28mm
<b>Net weight</b>	0.06Kg

**AVAILABLE VARIANTS**

**"Z" VARIANT**

**ADP08 Z**  
ADAPTER ONLY (DOES NOT INCLUDE BATTERY / CHARGER)



- DRILLING / FIXING
- CONCRETE DRILLING / DEMOLITION
- MIXING / STIRRING
- CUTTING (CONCRETE / METAL)
- GRINDING
- SANDING / POLISHING
- SAWING
- MULTI-TOOL
- ROUTERS / PLANERS
- NAILERS / STAPLERS
- HEAT GUN / LASER
- CLEANING
- OPE
- JOBSITE TOOLS
- SPECIALTY TOOLS
- HAND TOOLS / COMBINATION SET
- TOOL HOLDERS AND POUCHES / MAKPAC SYSTEM

**ADP06** 12V MAX | CXT

**Adapter**



**Charges mobile devices (smartphones, tablets)**

- Adapter is designed to attached with CXT batteries and can charge USB compatible device such as Smartphone, Tablet, etc
- Over discharge protection circuit
- Built-in hook
- Built-in strap hole attaches to a belt or holster
- Compatible with IOS and Android devices



<b>Voltage</b>	12V MAX Li-ion (CXT)
<b>USB port</b>	1
<b>Max output current A</b>	2.1
<b>Dimensions</b>	80x53x38mm
<b>Net weight</b>	0.07Kg

**AVAILABLE VARIANTS**

**"Z" VARIANT**

**ADP06 Z**  
ADAPTER ONLY (DOES NOT INCLUDE BATTERY / CHARGER)

**ADP09** 12V MAX | CXT

**Adapter / AA Battery Pack**



**Model ADP09 is an AA battery pack designed to supply power to the Laser powered by 12Vmax CXT Li-ion battery**

- Adapts AA Batteries to be used a power source
- Uses 8 x AA Batteries to power compatible 12Vmax CXT lasers (SK700GD, SK700D, SK40GD)
- Compatible with AA Zinc-Carbon/Alkaline/Ni-MH batteries

<b>USB port</b>	1
<b>Max output current A</b>	2.1
<b>Dimensions</b>	80x53x38mm
<b>Net weight</b>	0.07Kg

**AVAILABLE VARIANTS**

**"Z" VARIANT**

**Part # CP0000001**  
ADAPTER ONLY (DOES NOT INCLUDE AA batteries)

DRILLING / FIXING

## Adapters



For Model		Part No.
CF001G	AC Adaptor	TE00000441
DCF102, CF101D, CF100D	AC Adaptor	TE00000211
DCF301, CF002G	AC Adaptor	TE00000443
BMR100	AC Adaptor	SE00000078
DCW180, CW003G	AC Adaptor Assembly	WL00000059
CW001G	AC Adaptor Assembly	WL00000130
CW002G	AC Adaptor Assembly	WL00000321
DCW180, CW001G, CW002G, CW003G	Automotive Adapter	WL00000002
	AC power cord only	WL00000064

CONCRETE DRILLING / DEMOLITION

MIXING / STIRRING

CUTTING (CONCRETE / METAL)

GRINDING

SANDING / POLISHING

SAWING

MULTI-TOOL

ROUTERS / PLANERS

NAILERS / STAPLERS

HEAT GUN / LASER

CLEANING

OPE

JOBSITE TOOLS

SPECIALTY TOOLS

HAND TOOLS / COMBINATION SET

TOOL HOLDERS AND POUCHES / MAKPAC SYSTEM

## Flashlight Accessories Light Diffuser

Diffuses the light and reduces glare and expands the lighted area by diffusing the light



For Model	Mount Type	Part No.
DML811	Lamp Shade	GM00002287
DML809	Lamp Shade	GM00002286
ML003G	Anti-glare film	GM00002312
ML005G	Anti-glare film	■ GM00002359
ML009G	Anti-glare film	■ GM00002376
ML006G, DML816	Lamp Shade	GM00001326
ML009G	Lamp Shade	■ GM00002377
ML005G	Lamp Shade	■ GM00002358
ML011G, DML817	Lamp Shade	■ GM00002457

## Work Light Stand (Tripod)

For Model	Mount Type	Type	Set Screw	Part No.
DML805	992-1,750mm (Up to two lights can be mounted)	A	M8	GM00002283
DML805, ML003G, ML005G, ML009G	Vise - Use for mounting work light on a scaffolding pipe	B	M8	GM00001396
DML809, DML811, ML003G, ML005G	1,300-2,000mm (Up to two lights can be mounted)	C	M10 bolt & nut	GM00002073
DML809, DML811, ML003G, ML005G, ML009G	1,300-2,000mm (mounting single flashlight)	D	-	■ GM00002378
DML809, DML811, ML003G, ML005G	Flat Bar to be used with GM00002378 for mounting two flashlights	E	M10 bolt & nut	■ GM00002379

## Shoulder Strap

	Part No.
DCW180, CW003G, CW001G	A-71093
MW001G	196817-8

## Strap

- A: Strap with Hook  
Metal hang hook is convenient and job site durable
- B: Shoulder hook set
- C: Shoulder hook set



For Model	Mount Type	Part No.
ML001G	A: Strap with hook	GM00002280
ML002G, DML807	B: Shoulder strap with hook	GM00001028
ML007G, DML812	C: Shoulder strap with hook	GM00002239
DML815	A: Strap with hook	GM00001289
ML006G, DML816	B: Shoulder strap with hook	GM00001288
DML814	Shoulder strap	■ TD00000002
ML011G, DML817, DMR055	A: Strap with hook	■ SE00001178



Note:- ML009G is not recommended for mounting as 2pcs on a stand

# Speciality Tools

Rebar Tying Tool, Wall Scanner, Grease Gun, Caulking Gun, Vacuum Pump, Air Compressor



- DRILLING / FIXING
- CONCRETE DRILLING / DEMOLITION
- MIXING / STIRRING
- CUTTING (CONCRETE / METAL)
- GRINDING
- SANDING / POLISHING
- SAWING
- MULTI-TOOL
- ROUTERS / PLANERS
- NAILERS / STAPLERS
- HEAT GUN / LASER
- CLEANING
- OPE
- JOBSITE TOOLS
- SPECIALTY TOOLS
- HAND TOOLS / COMBINATION SET
- TOOL HOLDERS AND POUCHES / MAKPAC SYSTEM

# DTR181

18V | **LXT**

## Cordless Rebar Tying Tool



**NEW**

upto  
**5000 Ties**

(combination of 16mm x 2 rebars using 6.0Ah battery)

### Max tying capacity

Combination of 2 rebars:

**35mm + 13mm**

Combination of 3 rebars:

**25mm + (16mm x 2)**

Combination of 4 rebars:

**(16mm x 2) + (13mm x 2)**

**4 wire winding turn for maximum strength**

**6-Stage digital adjustment of tying strength to match various tension strength requirements**

### CONTINUOUS ACTUATION MODE

Hold the trigger and pull the contact plate against rebars



### COMPACT AND SLIM DESIGN

Enable to use in narrow areas

Center of gravity

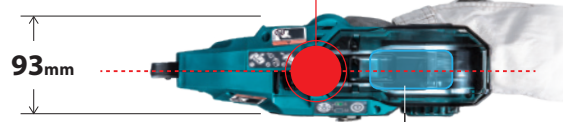

Easy to load with tie wire reel

### Selectable 2-Modes

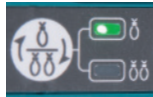

Single actuation



Continuous actuation

### Adjustable rebar tying strength

According to the condition of tying material, tying strength can be adjusted in 6 stages.



### TYING CAPACITY WITH DIFFERENT COMBINATION OF REBARS

	2 pcs of rebars					3 pcs of rebars			4 pcs of rebars			
	13mm	16mm	19mm	22mm	25mm	10mm x 2	13mm x 2	16mm x 2	10mm x 2	13mm x 2		
13mm	△	△	✓	✓	✓	10mm	△	✓	✓	10mm x 2	✓	✓
16mm	△	✓	✓	✓	✓	13mm	△	✓	✓	13mm x 2	✓	✓
19mm	✓	✓	✓	✓	✓	16mm	✓	✓	✓	16mm x 2	✓	✓
22mm	✓	✓	✓	✓	✓	19mm	✓	✓	✓			
25mm	✓	✓	✓	✓	✓	22mm	✓	✓	✓			
29mm	✓	✓	✓	✓		25mm	✓	✓	✓			
32mm	✓	✓										
35mm	✓											

△ The combination is not designed for high tying strength

Tie Wire	ø0.8 mm
Vibration Level	2.5 m/s <sup>2</sup> or less
Sound Pressure Level	82 dB(A)
Dimensions (L x W x H)	317 x 93 x 318 mm
Net weight	2.0 kg

Standard Equipment: Hex Wrench, Hook

### AVAILABLE VARIANTS

5.0Ah

"Z" VARIANT

**DTR181 RTJ**  
INCLUDES 1 BATTERY / 1 CHARGER / MAKPAC CASE

**DTR181 ZJ**  
TOOL ONLY (WITH MAKPAC CASE)  
(DOES NOT INCLUDE BATTERY / CHARGER)

### Wire guide

Part No. 162945-1 ■  
for Annealed wire and Poly Coated wire  
(Standard Equipment)



Part No. 1913F2-8 ■  
for Annealed wire and Galvanized wire  
(Optional)



### Accessories



**Tie wire set**  
Diameter: 0.8mm  
Length: 100m  
Pack: 50 pcs/ box  
Part No. 199137-9



**Galvanized Tie wire set**  
Strong and rust free  
Diameter: 0.8mm  
Length: 100m  
Pack: 50 pcs/ box  
Part No. 191A57-9

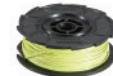

**Poly-Coated Tie Wire**  
Ideal for tying epoxy-coated rebar  
Diameter: 0.8mm  
Length: 100m  
Pack: 50 pcs/ box  
Part No. 191J59-9

### Extension Handle

Extension grip ensures a better working position  
- Angle Adjustment 200  
- Angle Length 250mm  
- Handle Length 175mm  
Part No. 191M27-0



**DWD181**

18V | **LXT**

**Cordless Wall Scanner**

High detection accuracy can detect objects embedded in concrete frame like metal, live electrical cables, plastic pipes and more

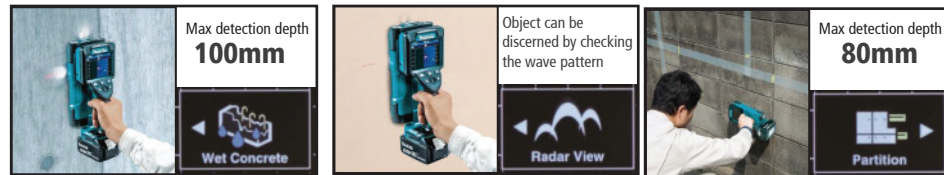

- Full-colour display: indicates object position, depth, etc on a large 4.1" screen
- The presence of object is indicated visually and acoustically
- Up to 3 detection results can be displayed on a split screen at a time
- Scene mode selection (Dry concrete / Wet concrete / Partition mode / Radar view mode)
- IP54 Dust and Drip proof design

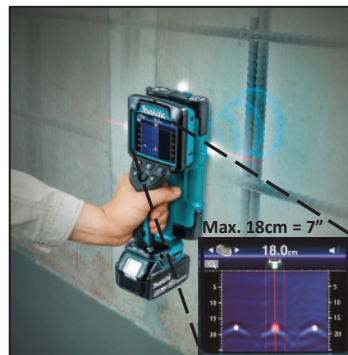

<b>Max Detection Depth</b>	Metal / Plastic Pipe / Live Cable / Wood: 180 / 120 / 120 / 25 mm
<b>Detection Accuracy</b>	+/-5 mm
<b>Minimum Detectable Distance</b>	40 mm
<b>Display Size</b>	4.1"
<b>Max Run Time (hours)</b>	w/ BL1860B: 28
<b>Operating Temperature</b>	-10 - 40°C
<b>Storage Temperature</b>	-20 - 50°C
<b>Dimensions (L x W x H)</b>	306 x 118 x 124 mm
<b>Net weight</b>	1.7 kg

**AVAILABLE VARIANTS**

**"Z" VARIANT**

**DWD181 ZJ**  
TOOL ONLY (WITH MAKPAC CASE) (DOES NOT INCLUDE BATTERY / CHARGER)

**DGP180**

18V | **LXT**

**Cordless Grease Gun**

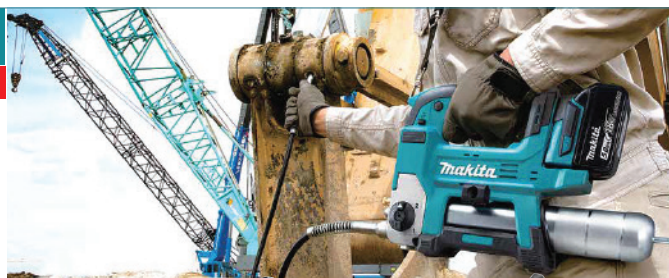

**For maintenance of heavy machinery**

- Auto speed change mode applies grease while varying the flow rate automatically matching the resistance of the part being greased
- Features two speed modes: Slow and Auto Speed Change
- Maximum 10,000psi discharge pressure and 295mL/min discharge rate
- Variable speed trigger for control over grease flow rate
- Able to dispense grease at high pressure
- Compatible grease Type: NLGI: No.0- No.2



<b>Max Operating Pressure</b>	69 MPa (10,000 PSI)
<b>Flow Rate</b>	Slow Speed Mode: 145 mL/min (5.0 oz/min) Auto Speed Change Mode: 290 mL/min (10.0 oz/min)
<b>Grease Capacity w/ Barrel A</b>	Cartridge / Bulk: 410 / 455 g (14.5 / 16.0 oz)
<b>Hose Length</b>	120 cm (47-1/4")
<b>Dimensions (L x W x H)</b>	w/ Barrel A: 411x114x245 mm
<b>Net weight</b>	5.4 kg (without battery)

**AVAILABLE VARIANTS**

<b>5.0Ah</b>	<b>"Z" VARIANT</b>
<b>DGP180 RT</b> INCLUDES 1 BATTERY / 1 CHARGER / PLASTIC CARRY CASE	<b>DGP180 Z</b> TOOL ONLY (DOES NOT INCLUDE BATTERY / CHARGER OR CARRY CASE)



**Adapter Set (3pcs)**  
1/8" NPT connection  
Part No. 191W60-2 ■



**Angle Adapter Set**  
90° grease coupler for hard-to-reach grease nipples  
Part No. 191A77-3



**Lock on Adapter Set**  
Locking grease coupler for a more secure connection to the grease nipple of a machine  
Part No. 191A76-5



**Flexible Hose with adapter**  
600mm  
Part No. 191A80-4 / 191W59-7 ■  
1200mm  
Part No. 191A79-9 / 191W58-9 ■  
(standard)



**Barrel Assembly**  
Bulk grease is directly loadable into the barrel. Not only grease cartridges but also bulk grease in pail can be loaded direct into the barrel  
Part No. 191B12-7 / 122D16-0 ■  
(standard)



**Cartridge Barrel**  
Barrel with view windows designed for user to easily check what type cartridge is being used  
Part No. 191F24-4 / 191W59-7 ■



**Extension pipe**  
Part No. 191IM9-1 ■

DRILLING / FIXING

CONCRETE DRILLING / DEMOLITION

MIXING / STIRRING

CUTTING (CONCRETE / METAL)

GRINDING

SANDING / POLISHING

SAWING

MULTI-TOOL

ROUTERS / PLANERS

NAILERS / STAPLERS

HEAT GUN / LASER

CLEANING

OPE

JOB SITE TOOLS

SPECIALITY TOOLS

HAND TOOLS / COMBINATION SET

TOOL HOLDERS AND POUCHES / MAKPAC SYSTEM

- DRILLING / FIXING
- CONCRETE DRILLING / DEMOLITION
- MIXING / STIRRING
- CUTTING (CONCRETE / METAL)
- GRINDING
- SANDING / POLISHING
- SAWING

DCG180
18V | LXT

Cordless Caulking Gun



**Excellent work efficiency.**

- Variable speed control by dial and trigger switch for maximum control of sealant flow rate
- 300ml and 600ml size holder can be used
- Anti-drip function stops excess from oozing out just on release of the switch trigger
- Rubberized soft grip provides comfortable grip and better control



Max pushing force	5,000N
No load speed	0-28mm/sec. (0-66in/min.)
Dimensions (L x W x H)	404x108x281mm
Net weight	2.1kg

**Standard Equipment:** Holder Set A, Safety Goggles

AVAILABLE VARIANTS

"Z" VARIANT

**DCG180 ZK**  
 TOOL WITH PLASTIC CARRY CASE (DOES NOT INCLUDE BATTERY / CHARGER)

- MULTI-TOOL
- ROUTERS / PLANERS
- NAILERS / STAPLERS
- HEAT GUN / LASER
- CLEANING
- OPE
- JOBSITE TOOLS
- SPECIALTY TOOLS
- HAND TOOLS / COMBINATION SET
- TOOL HOLDERS AND POUCHES / MAKPAC SYSTEM

Accessories

Standard Accessory - Set A

**300ml size Holder Holder Set A (Part No. 196351-8)**

360° rotatable cartridge holder 300 ml cartridges





Optional Accessory - Set B

**600ml size Holder Holder Set B (Part No. 1911T4-0)**

Holder B set





Holds (600ml) cartridge style, sausage style, bulk caulks and adhesives

Optional Accessory - Set D

**400ml size Holder Holder Set D (Part No. 191P89-6)**

Holds (400 ml) cartridge style, sausage style and bulk caulks

AC001G
40V MAX | XGT

Cordless Air Compressor



**Surrounding environment-friendly machine with low noise level**

- Rigid roll cage frame construction minimizes the chance of damage to the motor and compression units.
- Carry handle with rubberized grip designed for easy transportation
- Oil-free pump design
- Equipped with high operating efficiency motor



Tank	7.6 L (2 gal)
Cut-In Pressure	0.72 MPa (105 PSI)
Cut-Out Pressure	0.93 MPa (135 PSI)
Number of Outlets	1
Performance	34.0 L/min
Noise Level	68 dB(A)
Dimensions (L x W x H)	302x434x382 mm
Net weight	10.9kg (without battery)

**Standard Equipment:** Vacuum Pump Oil (Part no: AS00VP050M), Adapter

AVAILABLE VARIANTS

"Z" VARIANT

**AC001G Z**  
 TOOL ONLY (DOES NOT INCLUDE BATTERY / CHARGER)

DVP181
18V | LXT

Vacuum Pump



**Cordless vacuum pump for air purge during installation of room air conditioner (designed to purge large air conditioning systems)**

- Dual-stage compression method generate vacuum level much higher than Single-stage compression method
- 60 minutes long run time enough to complete most purging jobs achieved by using two BL1860B
- Battery guards minimize the possibility of battery damage even if the machine falls down.



Flow Rate	113 L/min
Ultimate vacuum	20 Pa
Motor speed	3,200 min <sup>-1</sup>
Oil Tank Capacity	300 mL
Inlet port	5/16", 3/8"
Dimensions (L x W x H)	383 x 193 x 210 mm
Net weight	6.9 kg (without battery)

**Standard Equipment:** Vacuum Pump Oil (Part no: AS00VP050M), Adapter

**Optional Accessories:** Vacuum Hose (AS0AI154MK)  
 Vacuum Pump Valve with vacuum gauge (AS0VP085MK)  
 Shoulder bag (199486-4)

AVAILABLE VARIANTS

"Z" VARIANT

**DVP181 ZK**  
 TOOL ONLY (WITH CARRY CASE) (DOES NOT INCLUDE BATTERY / CHARGER)

# Combo Kit



DRILLING / FIXING

CONCRETE DRILLING / DEMOLITION

MIXING / STIRRING

CUTTING (CONCRETE / METAL)

GRINDING

SANDING / POLISHING

SAWING

MULTI-TOOL

ROUTERS / PLANERS

NAILERS / STAPLERS

HEAT GUN / LASER

CLEANING

OPE

JOBSITE TOOLS

SPECIALTY TOOLS

CARRY CASE / TOOL HOLDERS / POUCHES

## DLX2466X

### 18V LXT COMBO (Blower + Cleaner)



DCL180Z  
Cordless Cleaner  
(18V LXT)

DUB185Z  
Cordless Blower  
(18V LXT)



196643-5  
Flexible Hose Set  
for DUB185



DC18RC  
LXT fast Charger

BL1830B  
1pc x 3.0Ah  
(18V LXT 3.0Ah)

Tool bag



## CLX203AX4

### 12V MAX CXT COMBO KIT (Percussion drill + Multi tool)



HP331DZ  
Percussion Driver Drill  
(12VMAX Li-Ion),

TM30DZ  
Multi-Tool  
(12VMAX Li-Ion)

BL1021B  
2pcs x 2.0Ah  
Batteries  
(12VMAX Li-Ion)

DC10WC  
10.8V -12VMAX  
CXT Li-ion Charger

Tool bag

13pcs  
Oscillating Multi  
Tool Accessories  
in a plastic case  
(TMA007  
Segment saw blade  
TMA009  
Plunge cut saw blade  
Sanding pad  
Abrasive Delta Paper  
with mixed grit sizes  
60, 80, 120, 180, 240.)



# Hand Tools / Combination Sets





# Tape Measure

Makita measurement tape which is highly durable and convenient to use. Normally when the scales are blurred or hook is lost, that would be the end of tape's life. This measuring tape is designed for professionals which has specially coated tape and hook protector's damper for absorbing shocks. This helps increasing durability of the measuring tape.



### 1. Special Coating

"DURA COAT" for 5 times more durable  
 "SILICA COAT" for easy note



### 2. High durability of Hook

Installed damper to absorb the shock on a hook  
 Hook protector to reduce the shock on a hook  
 Tightly fixed hook with "4rivets+protector"



### 3. Convenience

2-sided printing  
 Hook with magnet  
 "Matte finish" to easy to read scales  
 Standout



### Printed size

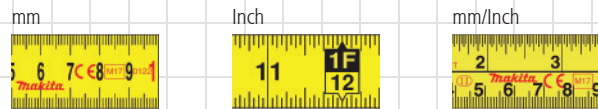

### Tape measure with holder & safety cord

The holder can be attached to waist belt and the measure can be attached/detached from a holder by single touch.



The measure and holder is tied by a safety cord so even you drop a measuring at high work place, safety cord avoids measure being fallen.



Attachable measure with a single touch. Press down the yellow lever and lift the measure.



- DRILLING / FIXING
- CONCRETE DRILLING / DEMOLITION
- MIXING / STIRRING
- CUTTING (CONCRETE / METAL)
- GRINDING
- SANDING / POLISHING
- SAWING
- MULTI-TOOL
- ROUTERS / PLANERS
- NAILERS / STAPLERS
- HEAT GUN / LASER
- CLEANING
- OPE
- JOBSITE TOOLS
- SPECIALTY TOOLS
- HAND TOOLS / COMBINATION SET
- TOOL HOLDERS AND POUCHES / MAKPAC SYSTEM

## Tape Measure



Size	Length	Width	Part No.
mm	3.5m	16mm	B-57130



Size	Length	Width	Part No.
mm/inch	5.5m/18ft	25mm/1"	B-57211
mm/inch	7.5m/25ft	25mm/1"	B-57227



Size	Length	Width	Part No.
mm	10m	25mm	B-57168



### Tape measure with holder & safety cord



Size	Length	Width	Part No.
mm	7.5m	25mm	B-57174

## Snap-off Knife

This snap-off knife is suitable for DIY user, repair shop, interior decoration, etc. It contains 7 spare blades inside the body plus the preinstalled blade on the body (total 8pcs blades).



	Part No
Snap-off knife	D-65713
Knife Blades 10pcs. Set	D-74734

## Retractable Utility Knife

- Quick blade change for easy and fast replacement
- Accepts all standard type utility knife blades
- Safety string cutter with recessed blade



	Part No
Retractable Utility Knife	B-65785
Knife Blades 10pcs. Set	B-65517

## Smooth face claw hammer

### Anti-Ring claw

Allows you to extract the nails which have been hammered by mistake

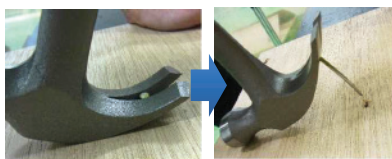

TYPE		PART NO
Smooth Face Claw Hammer	20 Oz	B-65779

## Combination wrenches

- Box End 15° offset providing knuckle clearance
- Ratcheting Function at Box End



SIZES	Pcs/Set	PART NO.
8,10,12,13,14,15,16,17,18mm	9pcs set	B-65539
8mm	1pc	E-11586
10mm	1pc	E-11592
12mm	1pc	E-11601
13mm	1pc	E-11617
14mm	1pc	E-11623
15mm	1pc	E-11639
16mm	1pc	E-11645
17mm	1pc	E-11651
18mm	1pc	E-11667
19mm	1pc	E-11673

## Hex key wrenches 9pcs set

- Ball point for confined place and fastening in max 25° angle



SIZES	Pcs/Set	PART NO.
1.5, 2, 2.5, 3, 4, 5, 6, 8, 10mm	9pcs set	B-65894

## Box-joint water pump pliers

- 24 positions of fine adjustment for optimum adaptation

Push button type adjustment



OVERALL LENGTH	MAX JAW SIZE	PART NO.
7" (180mm)	Ø37mm	B-65741
9.5" (240mm)	Ø49mm	B-65757

## Adjustable wrench

- Wide Capacity Jaw.
- Hex jaw design reduces slippage and grips bolt tightly.



SIZE (LENGTH)	JAW	PART NO
8" / 200mm	0-36mm	B-65420

## Aviation snips

Available in 4 types.

- Cuts Right - Cuts Left - Cuts Straight - Bulldog

Chrome-Molybdenum alloy steel forged blades for strength & durability. Center fastener for high tensile strength provided for longer life. Spring-free auto latch design for one hand operation provides safety and convenience



### Aviation snip - Cuts Right

CAPACITY		PART NO
Cold-rolled steel	18ga (1.22mm)	B-65816
Stainless steel	23ga (0.61mm)	



### Aviation snip - Cuts Left

CAPACITY		PART NO
Cold-rolled steel	18ga (1.22mm)	B-65800
Stainless steel	23ga (0.61mm)	



### Aviation snip - Cuts Straight

CAPACITY		PART NO
Cold-rolled steel	18ga (1.22mm)	B-65791
Stainless steel	23ga (0.61mm)	



### Aviation snip - Bulldog

CAPACITY		PART NO
Cold-rolled steel	16ga (1.63mm)	B-65822
Stainless steel	18ga (1.22mm)	

DRILLING / FIXING

CONCRETE DRILLING / DEMOLITION

MIXING / STIRRING

CUTTING (CONCRETE / METAL)

GRINDING

SANDING / POLISHING

SAWING

MULTI-TOOL

ROUTERS / PLANERS

NAILERS / STAPLERS

HEAT GUN / LASER

CLEANING

OPE

JOBSITE TOOLS

SPECIALTY TOOLS

HAND TOOLS / COMBINATION SET

TOOL HOLDERS AND POUCHES / MAKPAC SYSTEM

DRILLING /  
FIXING

### Locking Flex Pass thru Handle

TYPE	PART NO
Locking Flex Pass thru Handle	B-65626

CONCRETE  
DRILLING /  
DEMOLITION

### Pass thru handle Straight



TYPE	PART NO
Pass thru handle Straight	B-65610

MIXING /  
STIRRING

CUTTING  
(CONCRETE /  
METAL)

### Pass thru Socket



SIZE	PART NO
10mm	B-65648
11mm	B-65654
12mm	B-65660
13mm	B-65676
14mm	B-65682
15mm	B-65698
16mm	B-65707
17mm	B-65713
18mm	B-65729
19mm	B-65735

GRINDING

SANDING /  
POLISHING

SAWING

MULTI-TOOL

ROUTERS /  
PLANERS

### Pass thru extension bar



TYPE	PART NO
Pass thru Extension bar	B-65632

NAILERS /  
STAPLERS

### Socket adapter



TYPE	PART NO
Socket adapter	B-65844

HEAT GUN /  
LASER

CLEANING

### Tap Adapter



TYPE	PART NO
Tap Adapter	B-65872

OPE

### Ratcheting tap & die handle



TYPE	PART NO
Ratcheting tap & die handle	B-65866

JOBSITE  
TOOLS

SPECIALTY  
TOOLS

### Twist lock die adapter



TYPE	PART NO
Twist lock die adapter	B-65888

HAND TOOLS /  
COMBINATION SET

TOOL HOLDERS  
AND POUCHES /  
MAKPAC SYSTEM

### Ratchet & socket set



34PCS - 1/4" Ratchet & socket set	PART NO.
1/4" SQ 84T Ratchet, 1/4" bit adapter, 1/4" SQ slide T bar 1/4" SQ socket : 4, 4.5, 5, 5.5, 6, 7, 8, 9, 10, 11, 12, 13mm 1/4" SQ deep socket : 5, 6, 7, 8, 9, 10, 11, 12, 13mm 1/4" SQ Extension bar : 3", 6" T bit : T8, T10, T15, T20, T25, T27, T30, T40x25mm	B-65567
23PCS - 1/2" Ratchet & socket set	PART NO.
1/2" SQ 84T Ratchet, 1/2" SQ adapter to 3/8" SQ, 1/2" SQ universal joint 1/2" SQ socket : 10, 11, 12, 13, 14, 15, 16, 17, 18, 19, 20, 21, 22, 23, 24, 27, 30, 32mm 1/2" SQ Extension bar : 5", 10"	B-65589

### 21pcs. Screw Bit & Socket Set



The Screw Bits are very easy to distinguish due to the colour paint on the bit head

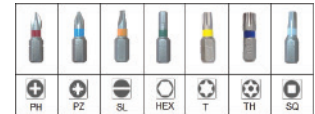

Type / Size /Pcs	PART NO
3Pcs - Phillips bits: PH1, PH2, PH3 x 25mm 2pcs - Slotted bits: SL0.8x5.5 x 25mm SL1.2x6.5 x 25mm 3pcs - Torx bits T20, T25, T30 x 25mm 2pcs - Pozi bits PZ1, PZ2 x 25mm 2pcs - Hex bits H4, H6 x 25mm 25mm Adapter - 1/4" Sand finished for hand	B-54081
6pcs - Socket Wrench with 6point for hand H5, H6, H8, H10, H12, H13 1pc Magnetic Bit Holder - 60mm Mini Ratchet Wrench - 100mm	

### Ratchet Handle

High durability ratchet handle with 84 teeth gear. 4.3° ratcheting arc. Able to work in tight spaces. Can be attached and detached with one touch socket wrench.



	PART NO
1/4" Drive Ratchet Handle, 84T	E-11558
1/2" Drive Ratchet Handle, 84T	E-11570

## Ratchet Screwdriver

With screw bit 25mm (PH2)x1pcs.  
Ratchet handle function is applied (clockwise and anticlockwise is possible).  
Suitable for car maintenance, interior decoration, repair room, DIY etc.



	Part No
Ratchet screwdriver	<b>D-58833</b>

## Screwdrivers (Price competitive range)

- Simple grip shape



TYPE	SIZE	Part No
PH1	100	<b>E-13356</b>
PH2	100	<b>E-13362</b>
PH3	150	<b>E-13378</b>
PZ1	80	<b>E-13384</b>
PZ2	100	<b>E-13390</b>
PZ3	150	<b>E-13409</b>
T10	100	<b>E-13415</b>
T15	100	<b>E-13421</b>
T20	100	<b>E-13437</b>
T25	100	<b>E-13443</b>
T30	100	<b>E-13459</b>
SL4	100	<b>E-13465</b>
SL5	100	<b>E-13471</b>
SL6	125	<b>E-13487</b>
SL8	150	<b>E-13493</b>

## Screwdrivers - Standard Type

- Ergonomic handle for best hand comfort.  
- Anti-Slip and Oil Resistant Dual Material.

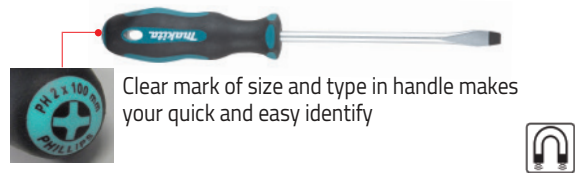

Clear mark of size and type in handle makes your quick and easy identify

TYPE	SIZE	Part No
PH1	100	<b>B-65903</b>
PH2	100	<b>B-65919</b>
PH3	150	<b>B-65931</b>
PZ1	80	<b>B-65947</b>
PZ2	100	<b>B-65953</b>
PZ3	150	<b>B-65969</b>
T10	100	<b>B-65975</b>
T15	100	<b>B-65981</b>
T20	100	<b>B-65997</b>
T25	100	<b>B-66008</b>
T30	100	<b>B-66014</b>
SL4.0	100	<b>B-66020</b>
SL5.5	100	<b>B-66036</b>
SL6.5	125	<b>B-66042</b>
SL8	150	<b>B-66058</b>

## Screwdrivers - Go Through Type

- Distinctive two tone grip design handle  
- Ergonomic handle for best hand comfort  
- Anti-Slip and Oil Resistant Dual Material



"Go-Through" construction provides greater striking force than traditional cap ends

TYPE	SIZE	Part No
PH1	75mm	<b>B-66064</b>
PH2	100mm	<b>B-66070</b>
PH3	150mm	<b>B-66086</b>
PZ1	75mm	<b>B-66092</b>
PZ2	100mm	<b>B-66101</b>
PZ3	150mm	<b>B-66117</b>
S5.5	75mm	<b>E-04933</b>
SL6.5	150mm	<b>E-04949</b>
SL8	200mm	<b>E-04955</b>

## 6pcs Screwdriver Set - Standard Type

Assorted pack of screwdrivers (standard type)

TYPE	PCS		Part No
PH1x100	1		<b>E-10528</b>
PH2x100	1		
PZ1x80	1		
PZ2x100	1		
SL4.0x100	1		
SL5.0x100	1		

TYPE	PCS		Part No
PH1x100	1		<b>E-10506</b>
PH2x100	1		
SL4.0x100	1		
SL5.5x100	1		
SL6.5x125	1		
SL8.0x150	1		

DRILLING / FIXING

CONCRETE DRILLING / DEMOLITION

MIXING / STIRRING

CUTTING (CONCRETE / METAL)

GRINDING

SANDING / POLISHING

SAWING

MULTI-TOOL

ROUTERS / PLANERS

NAILERS / STAPLERS

HEAT GUN / LASER

CLEANING

OPE

JOBSITE TOOLS

SPECIALTY TOOLS

HAND TOOLS / COMBINATION SET

TOOL HOLDERS AND POUCHES / MAKPAC SYSTEM

DRILLING / FIXING

CONCRETE DRILLING / DEMOLITION

MIXING / STIRRING

CUTTING (CONCRETE / METAL)

GRINDING

SANDING / POLISHING

SAWING

MULTI-TOOL

ROUTERS / PLANERS

NAILERS / STAPLERS

HEAT GUN / LASER

CLEANING

OPE

JOBSITE TOOLS

SPECIALTY TOOLS

HAND TOOLS / COMBINATION SET

TOOL HOLDERS AND POUCHES / MAKPAC SYSTEM

## Insulated Screw Drivers

- This driver is 1,000V insulated and has double insulated surface.
- Anti-Slipping and oil resistant material



Marking of size and type on the top of grip end.

TYPE	Part No
PH1x80	B-66123
PH2x100	B-66139
PH3x150	B-66145
PZ1x80	B-66151
PZ2x100	B-66167
PZ3x150	B-66173
T10x100	B-66189
T15x125	B-66195
T20x125	B-66204
T25x125	B-66210
T30x125	B-66226



## Shock Driver







Makita shock driver is very useful tool which is able to be used as a regular hand driver and a shock driver when you work on the stripped screw.



Size	Length	Part No
PH2	125mm	B-42438



This handy driver can remove the crushed or stripped screws which could not be loosened by electric tools. Applying the impact onto the handle generates a torque in the rotation direction, so the stripped screws can be removed.

Item	Screw removal	Stripped / Crushed screw removal
 MAKITA SHOCK DRIVER	 ✓	 ✓
 NORMAL SCREW DRIVER	 ✓	 ✗

### How to remove

While applying force in the fastening direction, hold the grip securely.

Apply strong impact with the hammer.

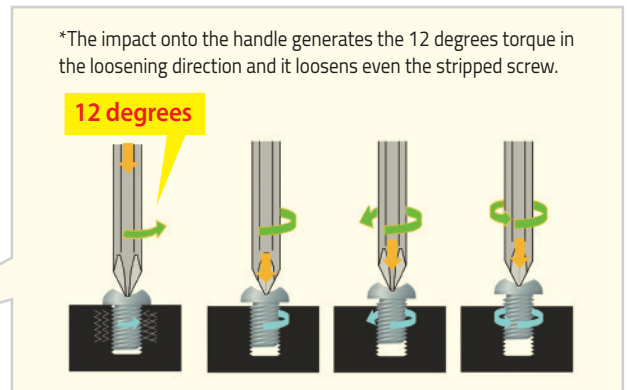
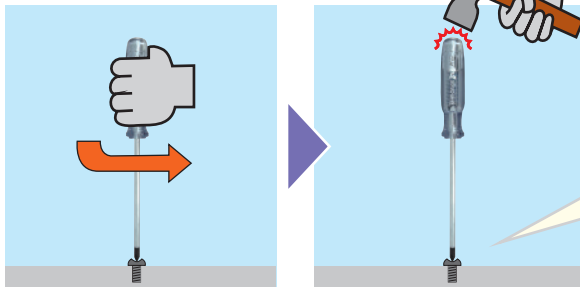

\*The impact onto the handle generates the 12 degrees torque in the loosening direction and it loosens even the stripped screw.

Please note: Our shock driver is intended for machine screws only. It is not suitable for screws into soft member such as wood screw or topping screw. Even after applying impact, the soft member might absorb the impact, or member itself might break. Also, it cannot be used for even machine screws that attach soft member such as aluminum, copper or thin board.

## LED Pen Light

Compact, light and easy to carry  
Application: Repair room,  
Car maintenance, DIY, etc  
Compatible with AA battery



Type / Size	Part No
LED Pen Light (without battery)	<b>D-58752</b>

## 10 pcs Bit Set

Popular drive bits are packed together in a convenient set.



Type / Size	Part No
2 x Philips: PH2x2pcs 4 x Pozi: PZ1x1pc, PZ2x2pcs, PZ3x1pc 2 x Torx: T15x1pc, T25x1pc 1 x Flat: 0.6x4.5 1 x Flat: 1.2 x 6.5	<b>P-16782</b>
1 x Holder	
Plastic box	

## 49 pcs Maklok and 4-way driver set



Type / Size / Pcs	Part no
40 x 25 mm (L) Screwdriver Bits Size: 10x Phillips: PH0x2pcs, PH1x2pcs, PH2x4pcs, PH3x2pcs 10x Pozi: PZ0x2pcs, PZ1x2pcs, PZ2x4pcs, PZ3x2pcs 8x Slotted: 3x2pcs, 4x2pcs, 5x2pcs, 6x2pcs 4x Torx: T10, T15, T20, T25 8x Hex: 3x2pcs, 4x2pcs, 5x2pcs, 6x2pcs	<b>P-52043</b>
5x Nutdrivers Size: 6/7/8/10mm & 5/16"	
1x Maklok Quick Change Chuck	
1x No.8 4xWay Driver Body with 25mm Pozi 2 Bit	
1x 4xWay Driver Barrel	
1x Industrial Quad-Driver Plastic Case	

## 14 pcs Mini Chuck Set

For use with 3 Jaw or Maklok chuck.



Type / Size	Part No
13x 25 mm Bits, Size: 3x Phillips: PH1x1pc, PH2x1pc, PH3x1pc 4x Pozi: PZ1x1pc, PZ2x2pcs, PZ3x1pc 4-Slotted: 3/4/5/6 mm 2-Hex: 4/6 mm	<b>P-51960</b>
1x Mini-Chuck	

## Stubby screw guide

Holds and guides screw in the correct position without wobbling or disengaging from the bit.



Type / Size	Part No
1x 80mm Stubby Screw Guide	<b>P-46268</b>
3x 25mm Bits, Size: 2x Pozidrive: PZ1, PZ2	
1x Slotted: 6-8	

## 12 pcs 4-Way Driver Set & Pouch



Type / Size	Part No
1x 4-Way Driver Barrel	<b>P-46327</b>
2x 4-Way Driver Body With No.8 Pilot and Pozi 2 Bits	
1x No.6 Pilot & Countersink Assembly	
1x No.10 Pilot & Countersink Assembly	
1x No.12 Pilot & Countersink Assembly	
6x Replacement Pilot Drill Bits	
Quick change driver and drill set with countersink	

DRILLING / FIXING

CONCRETE DRILLING / DEMOLITION

MIXING / STIRRING

CUTTING (CONCRETE / METAL)

GRINDING

SANDING / POLISHING

SAWING

MULTI-TOOL

ROUTERS / PLANERS

NAILERS / STAPLERS

HEAT GUN / LASER

CLEANING

OPE

JOBSITE TOOLS

SPECIALTY TOOLS

HAND TOOLS / COMBINATION SET

TOOL HOLDERS AND POUCHES / MAKPAC SYSTEM

DRILLING / FIXING

CONCRETE DRILLING / DEMOLITION

MIXING / STIRRING

CUTTING (CONCRETE / METAL)

GRINDING

SANDING / POLISHING

SAWING

MULTI-TOOL

ROUTERS / PLANERS

NAILERS / STAPLERS

HEAT GUN / LASER

CLEANING

OPE

JOBSITE TOOLS

SPECIALTY TOOLS

HAND TOOLS / COMBINATION SET

TOOL HOLDERS AND POUCHES / MAKPAC SYSTEM

### 29 pcs Drill bit, guide & driver set



Type / Size	Part No
8x 25mm BIT, W/Plastic Holder, Size: 4x Pozi: Pz0, Pz1, Pz2, Pz3 4x Phillips: Ph0, Ph1, Ph2, Ph3 4x Slotted: 4,5,6,7mm 2x Torx: T10, T15 2x Square: S1, S2	<b>P-46523</b>
1x Quick Change Adaptor	
1x Stubby Finder Driver	
1x 4xWay Driver Barrel	
1x 4-Way Driver Body	
1x Centre Drilling Guide Body	
8x Hexagon Shank HSS Drill Bits (Titanium Coated), Size: 2.5, 3.2, 3.5, 4, 4.5, 5, 5.5, 6mm	
Pouch Bag	

### 20 pcs Quick change Drill / Driver set



Type / Size	Part No
1x 1/4" Quick-Change Adaptor	<b>P-46311</b>
6x 1/4" Hexagon Shank HSS. Drill Bits (Titanium Coated), Size: 1.5, 2, 2.5, 3.2, 5, 6.5mm	
1x Stubby Finder/Driver With Pozi 2 Bit	
6x 25mm Screwdriver Bits, Size: 3x Phillips: Ph1, Ph2, Ph3 3x Pozi: PZ1/2/3	
5x 1/4" Drive Sockets, Size: 5/16", 6, 7, 8, 10mm	
1x Project Injection Case W/Clear Cover	

### 17pcs Drill bits Screwdriver Bit set

Set includes, metal, wood, masonry with different screwdriver bits and a sleeve chuck bit holder

A clear cover case allows the user to see the contents at a glance With durable plastic (butterfly) case



Type	Size (mm)	Pc/ Pkg	Part No
Screwdriver Bits	1/4" Hex (C-form)	PH1	25
		PH2	
		PH3	
		PZ2	
		H4	
		H5	
SLS			
Sleeve Chuck Bit Holder	E-form	60	<b>D-77207</b>
HSS-Tin Metal Drill Bits		5, 6, 8	
Wood Drill Bits		5, 6, 8	
Masonry Drill Bits		5, 6, 8	

### 17 pcs General Purpose Set



Type / Size	Pc/ Pkg	New Part No (With country of origin)
H.S.S. R Drill Bits	3, 4, 5, 6mm	4
Masonry Drill Bits	4, 5, 6, 8mm	4
	Philips: Ph1, Ph2	2
25mm Long Screw Driver Bits	Slotted: S0.8, S1.2	2
	Pozi: Pz2, Pz3	2
	Torx: T20, T25	2
Magnetic Bit Holder		1
Plastic case		



### 18pcs metal drill box set

3 different types of bits in 5 different sizes:

- HSS-G metal drill bit - for metal
- Masonry drill bit - for brick
- Brad point wood drill bit - for wood



	Size (mm)	Pc/ Pkg	New Part No (With country of origin)
HSS-G, Masonry, Wood drill bit	3, 4, 5, 6, 8, 10	Each 1pc	D-46202

### 9pcs Drill bits set (Assorted)

3 different types of bits in 3 different sizes:

- HSS-tin drill bit - for metal (3pcs)
- Carbide tipped drill bit - for masonry (3pcs)
- Wood drill bit - for wood (3pcs)



	Size (mm)	Pc/ Pkg	Part No
HSS-tin drill bit,	5	3	D-71962
Carbide tipped drill bit,	6	3	
Wood drill bit	8	3	

### Pilot Drill and Grub Screws

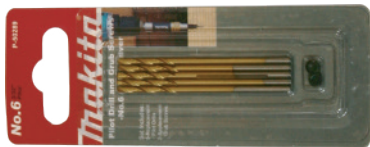

Type / Size	Part No
5 x Replacement Pilot Drills, Size: #6 (3/32") 2 x Replacement Grub Screws	P-50289
5 x Replacement Pilot Drills, Size: #10 (1/8") 2 x Replacement Grub Screws	P-50304

### 32 pcs Maklok Accessory Pouch

For use with 3 Jaw or Maklok chucks.



Type / Size	Part No
6x Nutdrivers, Size: 5/16" & 7/8/10/11/13mm	P-52021
16x 25mm(L) Bits, W/2pcs Plastic Holders, Size: 4x Hex: 3/4/5/6mm, 4x Slotted: 4/ 5/ 6/ 7mm 4x Torx: T10/ 15/ 20/ 25, 4x Pozzi: PZ1/ 2/ 2/ 3	
4x Hex Shank H.S.S. Drill, titanium coated, Size: 4/ 5/5.5/6mm	
4x Hex Shank Masonry Drill, Size: 4/ 5.5/ 7/ 8mm	
1x Stubby Screw Guide	
1x Maklok Quick Change Chuck	
Pouch	

DRILLING / FIXING

CONCRETE DRILLING / DEMOLITION

MIXING / STIRRING

CUTTING (CONCRETE / METAL)

GRINDING

SANDING / POLISHING

SAWING

MULTI-TOOL

ROUTERS / PLANERS

NAILERS / STAPLERS

HEAT GUN / LASER

CLEANING

OPE

JOBSITE TOOLS

SPECIALTY TOOLS

HAND TOOLS / COMBINATION SET

TOOL HOLDERS AND POUCHES / MAKPAC SYSTEM

## 65pcs sds-plus rotary hammers drill bits set



DRILLING / FIXING

- Part no: B-69478
- In makpac case
- Accessory set includes bits for drilling on metal, wood, masonry, screw bit and nutsetter for SDS-PLUS rotary hammer drill.

CONCRETE DRILLING / DEMOLITION

MIXING / STIRRING

CUTTING (CONCRETE / METAL)

GRINDING

SANDING / POLISHING

SAWING

MULTI-TOOL

ROUTERS / PLANERS

NAILERS / STAPLERS

HEAT GUN / LASER

CLEANING









OPE

JOBSITE TOOLS

SPECIALTY TOOLS

HAND TOOLS / COMBINATION SET

TOOL HOLDERS AND POUCHES / MAKPAC SYSTEM

No.	DESC.	Image	Shank	Size (mm)	Total length (mm)
1	HSS-TiN metal drill bit 135°Split point		SDS-PLUS (Short type)	3	90
2				3.5	100
3				4	105
4				4.5	110
5				5	116
6				5.5	123
7				6	123
8				6.5	131
9	Brad point Wood drill		SDS-PLUS (Short type)	4	105
10				5	116
11				6	123
12				8	147
13	SDS-PLUS Hammer drill		SDS-PLUS	10	163
14				6	160
15				7	160
16				8	160
17				10	160
18	25mm Screw bit		C-form	12	25
19				PH0	
20				PH0	
21				PH 1	
22				PH 1	
23				PH 2	
24				PH 2	
25				PH 2	
26				PH 3	
27				PH 3	
28				PH 3	
29				PZ0	
30				PZ0	
31				PZ 1	
32				PZ 1	
33				PZ 2	
34				PZ 2	
35				PZ 2	
36				PZ 3	
37	PZ 3				
38	PZ 3				
39	Slotted 0.8x4.0				
40	Slotted 0.8x4.0				
41	Slotted 0.8x5.0				
42	Slotted 0.8x5.0				
43	Slotted 1.0 x 5.5				
44	Slotted 1.0 x 5.5				
45	Slotted 1.2 x 6.5				
46	Slotted 1.2 x 6.5				
47	Hex. 3				
48	Hex. 4				
49	Hex. 5				
50	Hex. 6				
51	T10				
52	T15				
53	T20				
54	T20				
55	T25				
56	T25				
57	T30				
58	T40				
59	Magnetic Nutsetter		C-form	8	48
60				10	
61				12	
62				13	
63	HSS countersink		C-form	M6(12.7)	41
64	SDS-PLUS Sleeve chuck bit holder		SDS-PLUS (Short type)	-	80
65	Tape Measure			3m*19mm	

## 34 pcs Maccess Accessories set

**MACCESS**

## Type / Size

## Part No

7pcs HSS R Metal Drill Bits,  
Size: (2, 2.5, 3, 3.5, 4, 4.5, 5)mm5 x Masonry Drill Bits,  
Size: (4, 5, 6, 7, 8)mm5 x Wood Drill Bits,  
Size: (4, 5, 6, 7, 8)mm3pcs Philips Bits,  
Size: PH1-1pc, PH2-1pc, PH3-1pc3pcs Pozi Bits,  
Size: PZ1-1pc, PZ2-1pc, PZ3-1pc3pcs Slotted Bits,  
Size: 1-1pc, 1.2-1pc, 1.6-1pc3pcs Torx Bits,  
Size: T20-1, T25-1, T30-13pcs Socket Wrench,  
Size: (7, 8, 10)mm

1pc Magnet Bit Holder

1pc Countersink

Carrying Case

D-36996  
/ D-36980

## 71 pcs Maccess Accessories set

**MACCESS**

## Type / Size

## Part No

12 x HSS Metal Drill Bits  
(Titanium Coated)  
Size: (1.5, 2, 2.5, 3, 3.5, 4, 4.5,  
5, 5.5, 6, 6.5, 7)mm5 x Masonry Drill Bits  
Size: (3, 4, 5, 6, 8)mm5 x Wood Drill Bits  
Size: (4, 5, 6, 8, 10)mm3 x Flat Bits  
Size: (8, 15, 20)mm9 x Philips Bits (25mm)  
Size: PH1-3pcs, PH2-3pcs, PH3-3pcs9 x Pozi Bits (50mm)  
Size: PZ1-3pcs, PZ2-3pcs, PZ3-3pcs6 x Slotted Bits  
Size: (1- 1pc, 1.2- 3pcs, 1.6- 2pcs)mm4 x Allen Key screw  
Size: H3, H4, H5, H6Torx 6pcs Size: T20-2pcs, T25-2pcs,  
T30-1pc, T40-1pcSocket Wrench 4pcs  
Size: (8 10, 12, 13)mm

Magnet Bit Holder (1)

Counter Sink (1)

Diameter Gauge Transparent (1)

One Touch Bit Holder (1)

Carpet Knife (1)

Center Punch (1)

Screw Driver (Hand Tool) (1)

Size: 1/4" drive

3-m Measuring tape (1)

Carrying Case

D-37144

DRILLING  
/ FIXINGCONCRETE  
DRILLING /  
DEMOLITIONMIXING /  
STIRRINGCUTTING  
(CONCRETE /  
METAL)

GRINDING

SANDING /  
POLISHING

SAWING

MULTI-TOOL

ROUTERS /  
PLANERSNAILERS /  
STAPLERSHEAT GUN /  
LASER

CLEANING

OPE

JOBSITE  
TOOLSSPECIALTY  
TOOLSHAND TOOLS /  
COMBINATION SETTOOL HOLDERS  
AND POUCHES /  
MAKPAC SYSTEM

DRILLING /  
FIXING

CONCRETE  
DRILLING /  
DEMOLITION

MIXING /  
STIRRING

CUTTING  
(CONCRETE /  
METAL)

GRINDING

SANDING /  
POLISHING

SAWING

MULTI-TOOL

ROUTERS /  
PLANERS

NAILERS /  
STAPLERS

HEAT GUN /  
LASER

CLEANING

OPE

JOBSITE  
TOOLS

SPECIALTY  
TOOLS

HAND TOOLS /  
COMBINATION SET

TOOL HOLDERS  
AND POUCHES /  
MAKPAC SYSTEM

## 104 pcs Maccess Accessories set



Type / Size	New Part No (With country of origin)
14pcs HSS Metal Titan Drill Bits Size: (1.5, 2, 2.5, 3, 3.5, 4, 4.5, 5, 5.5, 6, 6.5, 7, 8, 10)mm	<b>D-37150 / D-31778</b>
5pcs Masonry Drill Bits Size: (3, 4, 5, 6, 8)mm	
7pcs Wood Drill Bits Size: (3, 4, 5, 6, 7, 8, 10)mm	
3pcs Flat Bits Size: (8, 15, 20)mm	
10pcs Philips Bits Size: PH1-2pcs, PH2-3pcs, PH3-3pcs, PH4-2pcs	
3pcs Philips Long Bits Size: PH2-1pc, PH3-1pc, PH4-1pc	
10pcs Pozi Bits Size: PZ1-2pcs, PZ2-3pcs, PZ3-3pcs, PZ4-2pcs	
3pcs Pozi Long Bits Size: PZ2-1pc, PZ3-1pc, PZ4-1pc	
6pcs Slotted Bits Size: 1-2pcs, 1.2-3pcs, 1.6-1pc	
4pcs Slotted Long bits Size: 1-1pc, 1.2-2pcs, 1.6-1pc	
4pcs Hex screw bits Size: H3, H4, H5, H6	
4pcs Hex Long screw bits Size: H3, H4, H5, H6	
9pcs Torx bits Size: T20-3pcs, T25-2pcs, T30-2pcs, T40-2pcs	
6pcs Torx Long Bits Size: T20-1pc, T25-1pc, T30-2pcs, T40-2pcs	
4pcs Socket Wrench Size: wSize: (8, 10, 12, 13)mm	
1pc Magnet Bit Holder	
Counter Sink	
Leveler	
Counter Chuck Holder	
1pc Knife	
1pc Screw Driver	
1pc 3m Measuring tape	
4pcs Depth Gauge Size: (8, 10, 12, 13)mm	
1pc Hex Wrench for depth gauge	
Carry Case	

## 75 pcs Drill & Screwdriver Bit Set

75pcs mixed accessory set includes wood, metal, masonry drill bits and various types of screwdriver bits that covers all common applications. Set comes in a compact plastic case.



Type / Size	Part No
21pcs Drill Bits 2pcs Wood Flat Bits - 16 and 22mm 5pcs Wood Brad Point Drill Bits - 3, 4, 5, 6, 8mm 5pcs TCT Drill Bits with straight shank - 3, 4, 5, 6, 8mm 9pcs Metal Drill Bits - 3, 3.2, 3.5, 4, 4.5, 5, 5.5, 6, 6.5mm	<b>E-15110</b>
48pcs Screwdriver Bits 40pcs of 25mm Screwdriver bits: PZ0, PZ1x2, PZ2x4, PZ3x2 PH0x2, PH1x2, PH2x4, PH3x2 SL0.5x3, SL0.5x4, SL0.6x5, SL1.0x6 T10, T15, T20x2, T25x2, T27, T30x2, T35, T40 HEX3, HEX4, HEX5x2, HEX6x2	
8pcs of 50mm Screwdriver bits: PH2x2, PH3, PZ2x2, PZ3, T25, T50	
4pcs Nut Setter (Non-magnet) 1/4" Hex - 6, 8, 10, 13mm	
2pcs Bit Holder 1pc Countersink Bit and 1pc Magnetic Bit Holder	

## 78 pcs Technician's Fixing Kit



Type / Size	Part No
1x 120mm Clear Magnetic Screw Guide	P-46492
2x Screw Finders	
7x HSS Drill, W/Hex Shank, Size: 1.5, 3.5, 4, 4.5, 5, 5.5, 6mm	
5x Masonry Drill W/Hex Shank, Size: 5, 6, 7, 8, 10mm	
5x Flats Bits, W/Hex Shank, Size: 16, 18, 22, 25, 32mm	
8x 1/4" Dr. 6pt Socket, W/Plastic Holder Size: 7/32, 1/4, 5/16, 3/8, 7/16, 11/32, 1/2, 9/16"	
8x 1/4" Dr. 6pt Socket, W/Plastic Holder Size: 5, 6, 7, 8, 9, 10, 11, 12mm	
20x 25mm Bit, W/Plastic Holder Size: 5x Poz: PZ0, PZ1, PZ2, PZ2, PZ3 3x Slotted: 3mm, 4mm, 5mm 2x Phillips: PH1, PH2, 5x Hex: 3, 4, 5, 5.5, 6mm 4x Torx: T10, T20, T25, T27 1x Bit Adaptor	
1x 1/4" Dr. Universal Joint	
1x 1/4" Dr. Ratchet Handle	
10x 50mm Bit, Size: 5x Poz: PZ1, PZ2, PZ2, PZ3, PZ3 2x Slotted: 4, 5mm, 3x Phillips: PH1, PH2, PH3	
1x 50mm(L) 1/4" x1/4" Bit Adapter	
1x Stubby Bit Driver W/Magnetic Tip	
1x 60mm Magnetic Bit Holder	
4x Hole Saw, Size: 16, 18, 20, 25mm	
1x Arbor Adapter,	
1x 1/4" Dr. 6" Flex. Extension	
1x Stud Finder Blow Molded Case	
Blow Moulded Case	

## 79 pcs Technician's Kit



Type / Size	Part No
1x 120mm(L) Compact Screw Guide	P-52065
2x Screw Finders	
7x Hex Shank HSS Drill W/Titanium Coated Size: 1.5 /3.5 /4 /4.5 /5 /5.5 /6mm	
5x Hex Shank Masonry Drill, Size: 5.5/6/7/8/10mm	
5x Hex Shank Flat Bits, Size: 16/18/22/25/32mm	
8x 1/4" Dr. 6pt Socket, W/Plastic Holder, Size: 7/32, 1/4, 5/16, 3/8, 7/16, 11/32, 1/2, 9/16"	
8x 1/4" Dr. 6pt Socket, W/Plastic Holder, Size: 5/6/7/8/9/10/11/12mm	
1x Bit Adaptor	
1x 1/4" Dr. Universal Joint	
1x 1/4" Dr., Ratchet Handle	
19x 25mm(L) Screwdriver Bit, Size: 5x Poz: PZ0, PZ1, PZ2, PZ2, PZ3 5x Hex: 3/4/5/5.5/6mm, 2x Phillips: Ph1, Ph2, 3x Slotted: 3mm,4mm,5mm 4x Torx: T10/20/25/27,	
10 x 100mm(L) Screwdriver Bit, Size: 5-Poz: PZ1,PZ2,PZ2,PZ3,PZ3 2-Phillips: Ph1, Ph2 3- Slotted: 3/4/5mm	
1x 50mm(L) 1/4" X1/4" Bit Adaptor	
1- Stubby Bit Driver	
1- 60mm Magnetic Bit Holder	
4x Hole Saw (For Metal Cutting), Size: 16/18/20/25mm	
1x Arbor	
1 x Stud Finder	
1x 230mm Flexible Drive Shaft	
1x Maklok Quick Change Chuck	
Nylon Pouch	

DRILLING  
/ FIXINGCONCRETE  
DRILLING /  
DEMOLITIONMIXING /  
STIRRINGCUTTING  
(CONCRETE /  
METAL)

GRINDING

SANDING /  
POLISHING

SAWING

MULTI-TOOL

ROUTERS /  
PLANERSNAILERS /  
STAPLERSHEAT GUN /  
LASER

CLEANING

OPE

JOBSITE  
TOOLSSPECIALTY  
TOOLSHAND TOOLS /  
COMBINATION SETTOOL HOLDERS  
AND POUCHES /  
MAKPAC SYSTEM

DRILLING / FIXING

CONCRETE DRILLING / DEMOLITION

MIXING / STIRRING

CUTTING (CONCRETE / METAL)

GRINDING

SANDING / POLISHING

SAWING

MULTI-TOOL

ROUTERS / PLANERS

NAILERS / STAPLERS

HEAT GUN / LASER

CLEANING

OPE

JOBSITE TOOLS

SPECIALTY TOOLS

HAND TOOLS / COMBINATION SET

TOOL HOLDERS AND POUCHES / MAKPAC SYSTEM

## 96 pcs Electrician's Tool Kit with Zipper case



Type / Size	Part No
6x Precision Screwdriver In Plastic Box, Size: 2x Phillips: Ph0, Ph1, 4x Slotted: 1.4, 2.0, 2.4, 3.0mm	<b>P-51851</b>
1x Utility Knife, 1x Stud Finder	
19x 25mm(L) Screwdriver Bits, Size: 5x Slotted: 3, 4, 5, 6, 7mm, 4x Phillips: PH1/2/2/3, 4x Pozi: PZ1, PZ2x2pcs, PZ3, 3x Torx: T15, T20, T25, 3x Hex: 4mm, 6mm, 7mm	
2x Hex/Square Drive Adaptor (25mm and 50mm)	
10x 50mm(L) Screwdriver Bits, Size: 3x Slotted: 4mm, 5mm, 6mm, 3x Phillips: PH1/2/3, 2x Pozi: PZ1/2, 2x Hex: 4mm, 5mm	
1x 50mm Magnetic Extension, 1x Screw Finder	
3x Depth Gauge, Size: 3,6,8mm	
1x 2.5 Hex Key, 1x Holesaw Arbor	
4x BixMetal Holesaws For Metal Cutting, Size: 16, 18, 20, 25mm	
14x Nutdrivers, Size: (7, 8, 9, 10, 11, 12, 13)mm & (1/4, 9/32, 5/16, 11/32, 3/8, 7/16, 1/2)"	
1x Maklok Quick Change Chuck	
7x Hex Shank HSS Drill Bits, Titanium Coated Size: 4, 5, 6, 7, 8, 9, 10mm	
5x Hex Shank Masonry Drill, Size: 5.5, 6, 7, 8, 10mm	
1 x 150mm Diagonal nose plier, GS handle, 1000V	
1 x 150mm Linesman plier, GS handle 1000V	
5 x Insulated Screwdrivers GD handle 1000V Size: 2 pc Slotted 3 x 100mm. 6.5 x 150mm	
3 pc Phillips: Ph0x75mm, Ph1x100mm, Ph2x100mm	
1 Ratchet bit driver, 1 X 3.5M Measuring tape	
1 X 300mm Spirit level, 1 X Carpenter's pencil	
1 X Clear screw guide, , 1x 150mm Drive Extension	
1x 6.4mm Drill Saw, Titanium Coated	
5x Hex Shank Flat Bits, Size: 16, 18, 22, 25, 32mm	
Zipper Case	

## 102 Piece Drill & Screw Bit Set



Type / Size	Part No
Tape measure	<b>E-10730</b>
Countersink	
Dry Wall Bit C-Form	
Diameter Gauge / 4 Depth Stops - 3, 5, 8, 10 / L hex wrench	
3 Flat Bits 1/4" Hex - 12, 16, 19	
4 Hole Saws - 32, 38, 40, 54	
Spirit Level	
30pcs of 25mm Screw Bits PZ1 x 2, PZ2 x 3, PZ3 x 2 PH1, PH2, PH3 T10, T15, T20, T25, T27, T30 HEX3, HEX4, HEX5, HEX6 SLO.5X3 x 2, SLO.5X4 x 2, SLO.6X4.5 x 2, SL1.0X6 x 2, SL1.2X7, SL1.2X8	
20pcs of 50mm Screw Bits SLO.5X3, SLO.5X4, SLO.6X4.5 PH1, PH2 x 2, PH3, PZ0, PZ1, PZ2 x 2, PZ3, T10, T20, T25, T27, HEX3, HEX4, HEX5, HEX6	
Screw Driver/ Bit driver handle	
13 Nut Setters 1/4" Hex - 5 x 2, 5.5, 6 x 2, 7 x 2, 8, 9, 10, 11, 12, 13	
6 Masonry Drill Bits - 3, 4, 5, 5.5, 6, 6.5	
6 Wood Drill Bits - 3, 4, 5, 5.5, 6, 6.5	
6 HSS-TiN Metal Drill Bits - 3, 4, 5, 5.5, 6, 6.5	
Magnetic Bit Holder	
Centre Punch	

## 103pcs Bit and Hand Tool Display Set (5 Set)

Comes as a pack of 5 sets



5 set package

Type / Size	Part No
4pcs Hole Saw (32, 38, 45, 54mm)	D-42341-5
1pc Hole Saw Arbor	
4pcs Depth Stop (3, 5, 8, 10mm)	
1pc Hex Key Wrench	
1pc Measure 3m	
1pc Long Nose Plier	
1pc Combination Plier	
1pc Adjustable Wrench	
3pcs Flat Bit (16/22/32mm)	
1pc Nail Hammer	
1pc Leveler	
1pc Diameter Gauge 1-10mm	
18pcs HSS-R Drill Bit (1, 1.5, 2x2pcs, 2.5, 3x2pcs, 3.5, 4x2pcs, 4.5, 5.5, 6, 6.5, 7, 8, 10mm)	
7pcs Masonry Drill Bit ( 3/4/5/5.5/6/7/8mm)	
7pcs Wood Drill Bit (3, 4, 5, 6, 7, 8, 10mm)	
40pcs Screw Driver Bit 25mm PH0x2pcs, PH1x2pcs, PH2x3pcs, PH3x3pcs PZ0x2pcs, PZ1x2pcs, PZ2x3pcs, PZ3x3pcs S4x2pcs, S6x2pcs, S7x2pcs H3, H4, H5, H6, T10x2pcs, T15x2pcs, T20x2pcs, T25x2pcs, T30, T40	
8pcs Socket (5, 6, 7, 8, 9, 10, 11, 13mm)	
1pc Socket adapter for 25mm Screwdriver	
1pc Counter Sink	
1pc Magnet Bit Holder	

DRILLING  
/ FIXING

CONCRETE  
DRILLING /  
DEMOLITION

MIXING /  
STIRRING

CUTTING  
(CONCRETE /  
METAL)

GRINDING

SANDING /  
POLISHING

SAWING

MULTI-TOOL

ROUTERS /  
PLANERS

NAILERS /  
STAPLERS

HEAT GUN /  
LASER

CLEANING

OPE

JOBSITE  
TOOLS

SPECIALTY  
TOOLS

HAND TOOLS /  
COMBINATION SET

TOOL HOLDERS  
AND POUCHES /  
MAKPAC SYSTEM

# Tool Pouches and Holders



## System as a BELT

Strap BELT can be easily detached from any Tool Bag or Tool Case and worn on the waist as a light-duty belt. Strap can be adjusted, which is flexible and convenient to fit your needs. Can be worn with any Makita Tool Pouch and Holder.

## System as STRAP

New in the market - unique STRAP Belt System with quick release buckles at the ends makes the belt multipurpose. Strap with comfortable soft rubber shoulder pad makes the lifting more comfortable. Fits to all Makita Tool Bags and Cases.



**STRAP/BELT SYSTEM**



**HEAVY-LOAD SUPPORT SYSTEM**



**WATERPROOF BOTTOM**



**DURABLE RIVETING**



**ELASTIC LOOPS**



**ANTI SLIP**



**3 LAYERS**



**REAL LEATHER**



**PEHD** Polyethylene High Density

**600 Denier** Polyester 600D

**1680 Denier** Polyester 1680D

**H** High Grade Leather

**PP** Polypropylene Tape

**RH** Rubbery Handle

**K** Holder For Knife

**E** Elastic Band

**R** Rivets

**BL** Bit Loops

**C** Carabiner

**PSB** Press Stud Button

**EI** Eye let

**ITC** Insulating Tape Chain

**MTC** Measuring Tape Clip

**HP** Holder For Pliers

**SHH** Side Gate Hammer Holder

**SHH** Swinging Hammer Holder

**MCS** Makita Cushioned Shoulder Pad

**TMB** Twin Pin Metal Buckle

**HS** Holder For Screwdriver

**3AM** 3D Air Mesh

**ZT** Zipper Tape

**QRB** Quick Release Buckle

**AS** Anti Slip Material

**HL** Hook & Loop



### Impact Driver Holster



- Universal design, comfortable for left & right handed users
- 2 hand tool holders on sides made of elastic loop
- 2 drill bit loops and one open loop for quick change adaptor

Specification	Part #
H x L x W 235 x 155 x 75mm	<b>E-05119</b>
Weight 0.13kg	

### Ultimate 2 Pocket Fixing Pouch



- Perfect foundation to start with professional tool belt set
- 2 big pockets to carry all necessary equipment & fixings
- 3 holders and 4 elastic side loops for easy-access tools
- D-ring to hang various tools and accessories

Specification	Part #
H x L x W 270 x 260 x 145mm	<b>E-05131</b>
Weight 0.51kg	

### Ultimate Electricians Pouch



- Designed to meet requirements for professional electrician
- 12 elastic loops at the front for easy-access
- 8 holders plus 3 elastic loops on sides
- 2 main 8deep pockets
- 1 leather holder and 2 polyester holders on sides

Specification	Part #
H x L x W 310 x 250 x 125mm	<b>E-05181</b>
Weight 1.7kg	

### Zip Top Pouch Dual Battery or Fixings



- Perfect basic pouch for various work activities
- Sits comfortably on any type of belt
- Keeps your tools handy when needed
- Safe, convenient and accessible
- Contains pockets & sleeves for nails, tools, battery, pencils, etc.

Specification	Part #
H x L x W 185 x 175 x 105mm	<b>E-05206</b>
Weight 0.24kg	

### Side Gate Hammer & Hand Tool Holder



- Stainless steel side gate hammer holder fits any hammer
- 2 additional elastic loops for pencil or screwdriver
- Sits comfortably on any type of belt

Specification	Part #
H x L x W 165 x 110 x 70mm	<b>E-05234</b>
Weight 0.15kg	

### Ultimate Heavyweight Tool Belt Set



- Can be loaded up with multiple pouches and holders
- Distributes weight of tools evenly around your waist for all day long comfort
- Carries everything: has pockets and sleeves for nails, spare parts, tools, pencils, etc.
- Quick dry air-mesh padding for more comfort

Specification	Part #
H x L 310 x 800mm	<b>E-05175</b>
Weight 1.73kg	

DRILLING / FIXING

CONCRETE DRILLING / DEMOLITION

MIXING / STIRRING

CUTTING (CONCRETE / METAL)

GRINDING

SANDING / POLISHING

SAWING

MULTI-TOOL

ROUTERS / PLANERS

NAILERS / STAPLERS

HEAT GUN / LASER

CLEANING

OPE

JBSITE TOOLS

SPECIALTY TOOLS

HAND TOOLS / COMBINATION SET

TOOL HOLDERS AND POUCHES / MAKPAC SYSTEM

DRILLING /  
FIXING

CONCRETE  
DRILLING /  
DEMOLITION

MIXING /  
STIRRING

CUTTING  
(CONCRETE /  
METAL)

GRINDING

SANDING /  
POLISHING

SAWING

MULTI-TOOL

ROUTERS /  
PLANERS

NAILERS /  
STAPLERS

HEAT GUN /  
LASER

CLEANING

OPE

JOBSITE  
TOOLS

SPECIALTY  
TOOLS

HAND TOOLS /  
COMBINATION SET

TOOL HOLDERS  
AND POUCHES /  
MAKPAC SYSTEM

### Quick Release Belt & Belt Loop



- Perfect basic belt for various work activities
- Base to build your own customized tool belt set
- Secured with a durable, high-impact plastic buckle
- Constructed for carrying multiple light duty pouches
- Double stitching all around the belt to ensure fabrics don't detach or fray

Specification	Part #
H x L	50 x 1,550mm
Weight	0.25kg

### Ultimate Padded Braces & Phone Holder



#### ANTI SLIP



- Integrate with (E-05175) Ultimate Heavyweight Tool Belt for best results
- Designed for professional use for all day comfort
- Lightweight and comfortable, incredibly strong & durable
- Chest adjustment fits wide range of body sizes

Specification	Part #
H x L x W	410 x 520 x 23mm
Weight	0.47kg

### Tape Measure Holder



#### ELASTIC LOOPS

#### STRAP/BELT SYSTEM 3 LAYERS



#### ANTI SLIP

- Adjustable and easy to use tape measure holder
- Specially designed pocket with holes to measure without taking the tape out
- 2 side loops for pencils and screwdrivers
- Can be used for tape measures 3m to 10m

Specification	Part #
H x L x W	165 x 110 x 80mm
Weight	0.14kg

### Tool Organizer Wrap



- Holds over 30 hand tools and accessories
- Cascaded rubber bands for optional tool placement
- Perfect for storing in car, truck, garage or tool box
- Easy grab & go style keeps your basic tools right at hand
- Large wrench roll ideal for construction workers

Specification	Part #
H x L x W	195 x 350 x 45mm
Weight	0.75kg

### Guide Rail Protective Holder



- Universal size to hold guide rails: 1.4M and 1.5M
- Protects your guide rails from scratches and shakes during transport or storage
- Strap Belt System included
- Constructed of heavy-duty 1680D polyester with foam for extreme durability

Specification	Part #
H x L x W	220 x 1565 x 45mm
Weight	1.45kg

# MAKPAC Cases

Cooler Box, Storage Cases, Makpac Trolley



DRILLING /  
FIXING

CONCRETE  
DRILLING /  
DEMOLITION

MIXING /  
STIRRING

CUTTING  
(CONCRETE /  
METAL)

GRINDING

SANDING /  
POLISHING

SAWING

MULTI-TOOL

ROUTERS /  
PLANERS

NAILERS /  
STAPLERS

HEAT GUN /  
LASER

CLEANING

OPE

JOBSITE  
TOOLS

SPECIALTY  
TOOLS

HAND TOOLS /  
COMBINATION SET

TOOL HOLDERS  
AND POUCHES /  
MAKPAC SYSTEM

# MAKPAC

MAKPAC is the cases can be stacked on top of each other and locked together with the locking latches. The interconnected cases take up less storage space and are easy to transport to and from the work site. Strong and collapsible carry handles make the cases easy to move and store while the rounded grips make it easy to remove the individual cases.

## MAKPAC CONNECTOR CASE

Innovative stackable case design for efficient organization, transporting and protection of tools  
Can be stacked on top of any Makpack cases with the locking latches.

The **MAKPAC** connector case system consists of four cases varying in height.

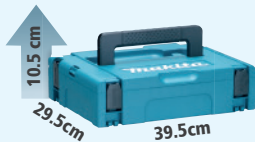

### CASE TYPE 1

Part No.: 821549-5

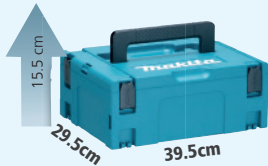

### CASE TYPE 2

Part No.: 821550-0



### CASE TYPE 3

Part No.: 821551-8

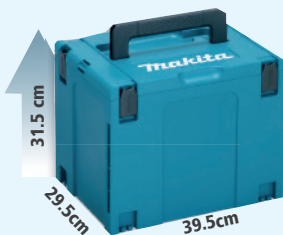

### CASE TYPE 4

Part No.: 140S63-9

## MAKPAC STORAGE BOX

For to carry hand tools and accessories  
Can be stacked on top of any Makpac cases with the locking latches.

Part No.: P-84137



## MAKPAC COOL BOX



Cool box is a great chilling bin for summer groceries, drinks and ice. Ideal For: Jobsite, Travel, Camping, Sports & Recreation Use

The **MAKPAC** cool box system consists of two cases varying in height.



### CASE TYPE 3

Part No.: 198254-2



### CASE TYPE 4

Part No.: 198253-4

## MAKPAC TROLLEY



The Makita MakPac Folding Trolley offers quick and easy transport of a stack of Makita MakPac cases. The maximum load of 125kg is more than enough to cope with a stack of power tools. A webbing belt secures the load to the trolley for safety. The handle is telescopic allowing you to select the most convenient height for comfortably moving the load around.

Part No.: TR00000002



## Makpac ADAPTER SET

Makpack adapter set to connects with Makita Vacuum Cleaner

### Suits only with Vacuum Model

VC3210LX1, VC3211HX1, VC003GL, VC004GL, VC005GL



Part No.: 198730-6

## Carbon Brushes

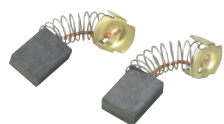

High Volt CB No.	Part No.	New Part No (With country of origin)	Low Volt CB No.	Part No.	New Part No (With country of origin)
1	181019-9	194961-5	1	181019-9	194961-5
51		194963-1	76		
55	181026-2	194964-9	75	191956-9	
64		194968-1	75	191956-9	
65		194969-9	76		
70	191914-5	194970-4	70	191914-5	194970-4
85	191998-3	194973-8	75	191956-9	
100		194974-6	124	191945-4	
106		194976-2	107	181437-1	
132		194984-3	132		194984-3
153		194985-1	154		194986-9
154		194986-9	154		194986-9
165	191936-5		166		
203		194991-6	203		194991-6
253	194547-5	194994-0	253	194547-5	194994-0
303		194996-6	303		194996-6
325		195001-2	325		195001-2
411		195010-1	408	191938-1	195008-8
415	191950-1	195012-7	401	191910-3	195005-4
419		195015-1	407	191927-6	
459		195026-6	458		

### Auto Cut- out Carbon Brush

105		194975-4	105		194975-4
155	181048-2	194987-7	155	181048-2	194987-7
175		195845-0	175		195845-0
204		194992-4	204		194992-4
327		195003-8	304		194997-4
318		194999-0	318		194999-0
350		195004-6	350		195004-6

### Carbon Brush for Cordless tool

424		195017-7			195017-7
430		195018-5	430		195018-5
434	193466-2		434	193466-2	
440		195021-6	440		195021-6
441		195022-4	441		195022-4
442		195023-2	442		195023-2
448	196854-2		448	196854-2	

# Makita - A Global Brand

Makita have established directly operated business bases in about 50 countries around the world, and have upgraded our sales network in over 170 countries and after-sales service capabilities to become one of the leading companies in our industry. In addition, Makita is producing power tools and OPE in China, Romania, Thailand, U.K., Brazil, U.S. and Germany. Currently, about 90% of our group's manufacturing work in terms of production volume is carried out overseas.

Makita's worldwide sales and service network, as well as the stable, high production quality ensured at its plants worldwide, are the embodiment of the Makita brand.

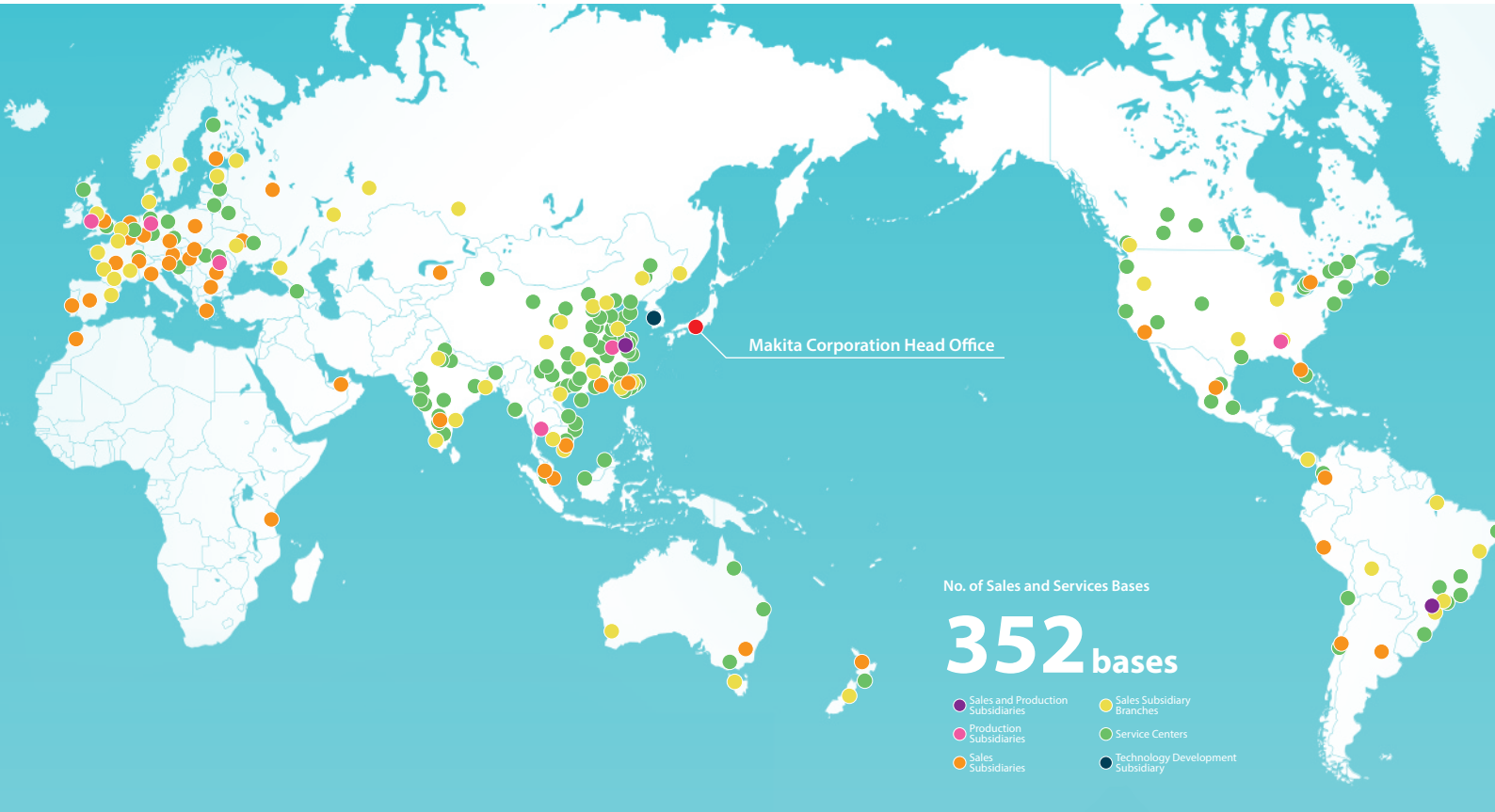

## JAPAN

Makita Corporation Headquarters



## JAPAN

Okazaki Plant



## U.S.A.

U.S. Plant



## UNITED KINGDOM

U.K. Plant



## ROMANIA

Romania Plant



## GERMANY

Germany Plant



## BRAZIL

Brazil Plant



## CHINA

China Plant (MCC)



## CHINA

China Plant (MKC)



## THAILAND

Thailand Plant



# MAKITA AUTHORIZED DISTRIBUTORS IN MIDDLE EAST AND AFRICA

## BAHRAIN

**M.H.AL.MAHROOS BSC (C)**  
P.O. BOX 65, MANAMA.  
TEL.: +973 17408090  
FAX: +973 17404323  
E-MAIL: almahroos@almahroos.com

## K.S.A

**KHUSHEIM CO. FOR INDUSTRIAL EQPT.**  
DAMMAM 31411,  
P.O. BOX 119.  
TEL.: +966 3 8333574  
FAX: +966 3 8325451  
E-MAIL: makita@khusheim.com

## KUWAIT

**ARABI COMPANY W.L.L.**  
MAKITA SHOWROOM CANADA DRY STREET,  
P.O. BOX 4090.  
TEL.: +965 24714551  
FAX: +965 24742566  
E-MAIL: powertools@arabiccompany.net

## OMAN

**GULF SERVICES & INDUSTRIAL SUPPLIES CO. L.L.C.**  
RUWI 112, P.O. BOX 2250.  
TEL.: +968 24814273  
FAX: +968 24816146  
E-MAIL: cs@arabigsis.com

## QATAR

**NEHMEH CORPORATION**  
175, HANDASA STREET, B-RING,  
P.O. BOX 99, DOHA.  
TEL.: + 974 4434 3000  
FAX: + 974 4442 3378  
E-MAIL: info@nehmeh.com

## U.A.E.

**NASER AL SAYER & CO. L.L.C.**  
P.O. BOX 1825, DUBAI.  
TEL.: +971 4 2222471  
FAX: +971 4 2275803  
E-MAIL: nasco@emirates.net.ae

## EGYPT

**CHEHAB EGYPT CO.**  
14 SARAY AL-AZBAKIA STREET,  
CAIRO, EGYPT.  
TEL.: +202 25903120  
FAX: +202 25927400  
E-MAIL: info@chehabegypt.com

## IRAQ

**AL USOOL GENERAL TRADING CO. LTD.**  
P.O. BOX 5508, BAGHDAD.  
TEL.: +964 780 929 0328  
+954 783 447 8767  
E-MAIL: info@usoolgroup.com

## JORDAN

**JORDAN INDUSTRIAL EQUIPMENT ESTABLISHMENT**  
P.O. BOX 620624 AMMAN 11162.  
TEL.: +962 6 4772815  
FAX: +962 6 4772809  
E-MAIL: info@makita.jo

## LEBANON

**CHEHAB BROTHERS S.A.L.**  
SAIFI, NAJIB HOUBAIKA STREET,  
CHEHAB BROS BLDG.  
P.O. BOX 11-3651,  
1107 2140 RIAD EL-SOLH, BEIRUT.  
TEL.: +961 1 566535  
FAX: +961 1 562532  
E-MAIL: azchehab@chehab-bros.com

## BURUNDI

**BRUNO JAUMAIN**  
P.O. BOX 658 BUJUMBURA.  
TEL.: +257 22 229431  
FAX: +257 22 211518  
E-MAIL: bruno.frigo@hotmail.com

## BURUNDI

**KIBOKO TOOLS BURUNDI**  
NO.25, AV. NTAHANGWA, Q. ASIATIQUE,  
ROHERO, BUJUMBURA.  
TEL.: +257 75 67 67 67

E-MAIL: kibokotools@gmail.com

## DJIBOUTI

**ETS. TANI BOULAOS (BOULAOS, SOUTH INDUSTRIAL ZONE)**  
P.O. BOX 2035, REPUBLIQUE DE DJIBOUTI.  
TEL.: +253 21 250980  
FAX: +253 21 352333  
E-MAIL: tani.boulaos@etstani.com

## DJIBOUTI

**AL GAMIL**  
ZONE INDUSTRIELLE GABODE BP2997.  
TEL.: +253 2135 6659  
FAX: +253 2135 6289  
E-MAIL: alshami@algamil.net

## ETHIOPIA

**ABDURAHMAN A. SHERIF**  
P.O. BOX 2147, MERKATO NEAR ANWAR MESGID,  
ADDIS KETEMA SUB CITY, ADDIS ABABA.  
TEL.: +251 11 2755590  
FAX: +251 11 2755122  
E-MAIL: asherifco@gmail.com

## KENYA

**INTERCROSS AGENCIES LTD.**  
BARICHO ROAD, PLOT# 33, BEHIND TOYOTA.  
TEL.: +254 20 6654644 / +254 73 4491645  
E-MAIL: icross@swiftkenya.com

## MAURITIUS

**ALBERT TRADING LTD.**  
17 BRABANT STREET, PORT LOUIS,  
REPUBLIC OF MAURITIUS.  
TEL.: +230 2080199  
FAX: +230 2112404  
E-MAIL: toolsdiv@albertgroup.mu

## RWANDA

**SOFARU LTD.**  
KN 1 RD 48, BOULEVARD DE LA NYABUGOGO,  
P.O. BOX 3290, KIGALI.  
TEL.: +250 786 394 551  
E-MAIL: sofaru10@yahoo.fr

## SEYCHELLES

**BODCO LTD**  
BODCO BUILDING,  
HARBOUR TRADING ESTATE, PORT VICTORIA,  
P.O. BOX 270, VICTORIA, MAHE.  
TEL.: +248 4285700, 4285711, 4285712  
FAX: +248 4224065  
E-MAIL: bodco@seychelles.net

## SOUTH SUDAN

**ZEREGABER GENERAL TRADING CO. LTD.**  
MALAKIA UNITY ROAD,  
OPPOSITE ANTIPAS PHARMACY, JUBA.  
TEL : +211 929 093 877 | +211 928 597 360  
E-MAIL: makitasouthsudan@gmail.com

## TANZANIA

**ASAR LTD.**  
10 INDIA STREET, P.O. BOX 674,  
DAR ES SALAAM.  
TEL.: +25522 2121656  
FAX: +25522 2113931  
E-MAIL: sales@asar.co.tz

## UGANDA

**KIBAO INVESTMENTS CO. LTD.**  
PLOT 117/119, SIXTH STREET, KIBAO,  
OPP. CITY TYRES, POBOX 10356,  
KAMPALA.  
TEL.: +256 41 4232207 | +256 41 4286109  
E-MAIL: kibaokampala@gmail.com



**MAKITA GULF FZE**  
P.O. BOX: 17133, JAFZA (SOUTH),  
DUBAI, U.A.E.

TEL: +971-4-8860804  
EMAIL: marketing@makitagulf.ae  
WEB: www.makita.ae



MAKITA MIDDLE EAST AFRICA

**JAPAN****Makita Corporation****Head office**

3-11-8, Sumiyoshi-cho, Anjo, Aichi  
446-8502  
Phone: +81-(0)566-98-1711  
Fax: +81-(0)566-98-6021  
www.makita.co.jp

**Okazaki plant**

22-1, Watarijima, Nemunoki-cho,  
Okazaki, Aichi 444-0232  
Phone: +81-(0)564-43-3111

**Nisshin Office**

349 Minamiyama,  
Komenoki-cho, Nisshin,  
Aichi 470-0111  
Phone: +81-(0)561-75-1500

**Tokyo branch office**

3-5-3, Hongo, Bunkyo-ku,  
Tokyo 113-0033  
Phone: +81-(0)3-3816-1141  
Fax: +81-(0)3-3813-1633

**Nagoya branch office**

2-33, Namiki, Nakamura-ku,  
Nagoya 453-0856  
Phone: +81-(0)52-419-0561  
Fax: +81-(0)52-413-0081

**Osaka branch office**

1-26-8, Tenma, Kita-ku,  
Osaka 530-0043  
Phone: +81-(0)6-6351-8771  
Fax: +81-(0)6-6352-4607

**Domestic sales offices**

Sapporo, Sendai, Niigata, Utsunomiya,  
Saitama, Chiba, Yokohama, Shizuoka,  
Gifu, Kanazawa, Kyoto, Hyogo, Okayama,  
Hiroshima, Takamatsu, Fukuoka,  
Kumamoto, Okinawa and other major  
cities

**CHINA****Makita (China) Co., Ltd.****Head office & plant (MCC)**

No.1388 Middle Huangpujiang Road,  
Kunshan Economic & Technical  
Development Zone, Jiangsu, China  
Postcode: 215335  
Phone: +86-(0)512-57707710  
Fax: +86-(0)512-57713623  
www.makita.com.cn

**Domestic sales department (MCS/MCCF)**

No.318, South Wusongjiang Road,  
Kunshan City, Jiangsu, China  
Postcode : 215300  
Phone: +86-(0)512-57037500  
Fax: +86-(0)512-57037118  
www.makita.com.cn

**Domestic sales department (MCCS)**

No.80 Meigui Road, Kunshan Economic  
& Technical Development Zone, Jiangsu,  
China  
Postcode : 215300  
Phone: +86-(0)512-57567710

**Guangzhou sales branch (CGZ)**

Rome 1001 1002, The First Floor, Jinhao  
Building, No.38, Middle Of Huadi  
Avenue, Li Wan  
District, Guangzhou, Guangdong, China  
Postcode : 510380  
Phone: +86-(0)20-87518872  
Fax: +86-(0)20-87518873

**Shanghai sales branch (CSH)**

Room.102&103, 1F, No.128, East Luoxiu  
Road, Xuhui District, Shanghai, China  
Postcode : 200231  
Phone: +86-(0)21-54487198  
Fax: +86-(0)21-62476732

**Tianjin sales branch (CTJ)**

No.3 Office Building, No.23, Quanwang  
Road, Wuqing Development  
Area, Tianjin, China  
Postcode : 301700  
Phone: +86-(0)22-29395799  
Fax: +86-(0)22-29395769

**Chengdu sales branch (CCD)**

2F, Building 1, Hatchery Building, No.9, Wu  
Ke Dong San Road, Wu Hou  
District, Chengdu, Sichuan, China  
Postcode : 610045  
Phone: +86-(0)28-85366002  
Fax: +86-(0)28-87337018

**Shenyang sales branch (CSY)**

No.2, 10A, No.7 Street, Economic and  
Technological Development Zone,  
Shenyang, Liaoning, China  
Postcode : 110141  
Phone: +86-(0)24-22530648  
Fax: +86-(0)24-22530170

**Xian sales branch (CXA)**

1 & 2F, Xian Youzhi Science and Technology  
Industrial Park NO.75 Mingguang Road,  
Economic And Technological Development  
Zone, Xian, Shanxi, China  
Postcode : 710018  
Phone: +86-(0)29-86223736  
Fax: +86-(0)29-86229230

**Changsha sales branch (CCS)**

(Near Gaosheng Road) No.3, Building  
5, Youxin Mechanical And Electrical  
Market, Yuhua District, Changsha, Hunan,  
China  
Postcode : 410114  
Phone: +86-(0)731-8526-7792  
Fax: +86-(0)731-8526-7791

**Shijiazhuang sales branch (CSJ)**

No.15, F District, Wanlian International  
Mechanical And Electrical City, No.560,  
Heping East Road, Changan  
District, Shijiazhuang, Hebei, China  
Postcode: 050000  
Phone: +86-(0)311-89864089  
Fax: +86-(0)311-85024612

**Makita (Kunshan) Co. Ltd.**

No.1, Nanzi Road, Kunshan Economic &  
Technical Development Zone,  
Jiangsu, China  
Postcode: 215300  
Phone: +86-(0)512-57367367  
Fax: +86-(0)512-57365575

**Makita Power Tools (HK) Ltd.****Head office**

Unit 1, 17/F., Grandtech Centre,  
8 On Ping Street, Shatin, N.T., Hong Kong  
Phone: +852-2648-8683  
Fax: +852-2648-5237

**Macau Service Centre**

Em Macau, Rua Do Volong N°11,  
Rês-Do-Chão A  
Phone: +853-2835-4587  
Fax: +853-2835-4135  
www.makita.com.hk

**Makita (Taiwan) Ltd.****Head office**

No.798, Sec. 2, Wenhua 3rd Rd.,  
Linkou Dist., New Taipei City 24459,  
Taiwan  
Phone: +886-(0)2-8601-9898  
Fax: +886-(0)2-8601-2266  
www.makita.com.tw

**Taichung sales branch**

No. 839, Section 3, Zhongqing Rd, Daya  
Dist, Taichung City, 428, Taiwan  
Phone: +886-(0)4-2392-1650  
Fax: +886-(0)4-2392-1653

**Kaohsiung sales branch**

No.105, Yucheng Rd., Sanmin Dist.,  
Kaohsiung City 807, Taiwan  
Phone: +886-(0)7-343-0292~4  
Fax: +886-(0)7-341-3602

**Yilan factory service center**

No. 237, Section 3, Chuanyi Rd, Luodong  
Township, Yilan County, 265, Taiwan  
Phone: +886-(0)3-956-7801  
Fax: +886-(0)3-956-7877

**Hualien factory service center**

No.247, Sec.2, Zhongyang Rd.,  
Ji'an Township, Hualien County 973,  
Taiwan  
Phone: +886-(0)3-852-8901  
Fax: +886-(0)3-852-8515

**Yunlin factory service center**

No.197, Guangfu Rd., Huwei Township,  
Yunlin County 632, Taiwan  
Phone: +886-(0)5-632-8200  
Fax: +886-(0)5-632-8190

**Tainan factory service center**

No. 182, Minzhi Rd, Xinying District,  
Tainan City 730, Taiwan  
Phone: +886-(0)6-656-5651  
Fax: +886-(0)6-656-7800

**Pingtung factory service center**

No.12&16, Ruimin Rd.,  
Pingtung City 900, Taiwan  
Phone: +886-(0)8-722-0001  
Fax: +886-(0)8-722-0733

**Taitung factory service center**

No. 51, Section 2, Zhongxing Rd, Taitung  
City, Taitung County 950, Taiwan  
Phone: +886-(0)89-232-301  
Fax: +886-(0)89-232-322

**SINGAPORE****Makita Singapore Pte. Ltd.****Head Office**

7, Changi South Street 3, Singapore 486348  
Phone: +65-6546-8700  
Fax: +65-6546-8711  
www.makita.com.sg

**Myanmar Service Center**

No.D36/2, Lan Thit Road, Insein Township, Yangon.  
Phone: +95-(0)9-76232-6433  
+95-(0)9-76911-5388

**Cambodia Service Center**

No. 432, Street 271, Phum Chamroen  
Phal 4, Sangkat Boeung Tumpun 1, Khan  
Meanchey, Phnom Penh, CAMBODIA.  
Phone: +855-(0)78-994-071  
https://www.makita.com.kh/

**INDIA****Makita Power Tools India Pvt. Ltd.****Head Office**

Unit 2, Sy. No. 93/3 & 93/4,  
Koralur Village, Kasaba Hobli,  
Hoskote Taluk, Bangalore – 560067.  
India.  
Phone: +91-(0)80-2205-8200  
Fax: +91-(0)80-2854-9007  
www.makita.in

**Delhi Branch**

Khasra No. 1035, Village Mundka, Near  
Ganpati Dharam Kanta, Delhi – 110041,  
India  
Phone: 011-28341102

**Chennai Branch**

No.30, Jawaharlal Nehru Salai,  
Koyambedu, Chennai – 600107. India.  
Phone: +91-(0)44-2479-2522  
Fax: +91-(0)44-2479-2533

**Kolkata Branch**

P-46, Hide Road Extension,  
Kolkata – 700088.  
West Bengal, India.  
Phone: +91-(0)33-2439-1030 / 1060

**Bangalore Service Centre**

Sowbhagya M Gopi Nilaya No. 66,  
Mission Road, 2nd Main, Sudhamanagar,  
Bangalore – 560027, India.  
Phone: +91-80-2222-8200

**Cochin Branch**

Door No. XVI/443A, Jubilee Road, Kerala  
– 682040. India  
Phone: +91-8590432003

**Mumbai Service Centre**

Shop No.3, on Ground Floor,  
Commercial Chamber, bearing  
Municipal Street No.76, and 72/80,  
Nagdevi Cross Lane, Mumbai 400003.  
Phone: +91(0)22-4974-4092

**Ahmedabad Service Centre**

Aniket Estate, Near Sawan Hotel, Near  
Sarkhej – Sanand Chokdi, S. G. Highway,  
Ahmedabad – 382210. India.  
Phone: +91-6358737996

**Hyderabad Service Centre**

3-3-10, Kings Way, Rashtra Pathi Road,  
Secunderabad – 500003. India.  
Phone: +91(0)40-4003-8000

**Peenya Service Centre**

No. 36/B, F1, 2nd Phase, 1st Main Road,  
KIADB, NTTFCircle, Peenya Industrial  
Area, Bangalore – 560058  
Phone: +91-9606980302

**Pune Service Centre**

Shop No. 104, First Floor, Plot No.  
PAP/J/121/122. J Block, MIDC Bhoasari,  
Pimpri Chinch Wad, Pune - 411026  
Phone: 020-46300061

**Rudrapur Service Centre**

MIG-48, Ground Floor, Ward No. 19, New  
Ward no. 38, Near Siddhu Palace, Awast  
Vikas, Rudrapur, Uttarakhand - 263153  
Phone: +91 7042597756

**Trichy Service Centre**

No. 4 & 5, No.S1/17A, EGA PLAZA,  
Trichy Tanjore Main Road, Thuvakudi,  
Tiruchy - 620015, India  
Phone: +91 9600291989

**Jamshedpur Service Centre**

Shop no. 24, Shivaranjani Complex, Plot  
no. ST-8, Mouzadindli, Adityapur,  
P.S.Adityapur Ward no. 5, Saraikel (D),  
Kharwan, Jharkhand State  
Phone: 0657 - 2383024

**Indore Service Centre**

Unit No. B-34, Block No. B-18, Access B,  
New Siyaganj, Poddar Plaza, HTL, Unit 2,  
VIP Route No.1, Kachhi Mohalla, Indore  
Phone: 0731-3593608

**Vadodara Service Centre**

Shop No. 3, Lakod Complex, GIDC,  
Makarapura, Vadodara, Gujarat  
Phone: Mob. +91 88665 53756

**Guwahati Service Centre**

Sahani Mansion, Chatribari Road,  
Guwahati, Kamrup Metropolitan,  
Assam - 781001, India.  
Phone: 036-13514572

**Coimbatore Service Centre**

D.No.138/6, Ground Floor, Rangakonar Street,  
Kator, Coimbatore - 641009, Tamilnadu.  
Phone: 0422-3510235

**VIETNAM****Makita Vietnam Co. Ltd.****Head office**

Unit 4-5-6, Block 16 18 L1-2, Street 3,  
VSIP II Industrial Park, Hoa Phu Ward,  
Thu Dau Mot City, Binh Duong Province,  
Vietnam.  
Phone: +84-274-362-8338  
Fax: +84-274-362-8339  
www.makita.com.vn

**North Branch**

Unit 05, No.01, Street 6, VSIP Bac Ninh  
Intergrated Township and Industrial  
Park, Phu Chan Ward, Tu Son Town, Bac  
Ninh Province, Vietnam  
Phone: +84-222-376-5942  
Fax: +84-222-376-5941

**Da Nang Service Center**

102 Trieu Nu Vuong Street, Hai Chau 1  
Ward, Hai Chau District, Da Nang City,  
Vietnam.  
Phone: +84-236-352-5079  
Fax: +84-236-352-5479

**Can Tho Service Center**

366 Vo Van Kiet Street, 5 Zone, An Thoi  
Ward, Binh Thuy District, Can Tho City,  
Vietnam.  
Phone: +84-292-389-4358  
Fax: +84-292-389-4359

**Buon Ma Thuot Service Center**

68 Le Duc Thu, Thang Loi Ward, Buon Ma  
Thuot City, Dak Lak Province, Vietnam  
Phone: +84-262-355-4556  
Fax: +84-262-355-4557



## ASIA

### Hai Phong Service Center

No. 01 Lot OH-01, Huy Hoang Riverside project, Thuong Ly Ward, Hong Bang District, Hai Phong City, Viet Nam  
Phone: +84-225-883-1429/1529

### Nha Trang Service Center

Lot 36-38, Road B6, Vinh Diem Trung Urban Area, Vinh Ngoc Ward, Nha Trang City, Khanh Hoa Province, Viet Nam  
Phone: +84-258-382-3338

### Ho Chi Minh Service Center

12 Trinh Van Can, Cau Ong Lanh Ward, 1 District, Ho Chi Minh City, Viet Nam  
Phone: +84-283-821-5191

### Ha Noi Service Center

Group 15 and No. 4, Alley 63, Truong Chinh Street, Phuong Liet Ward, Thanh Xuan District, Hanoi City, Viet Nam  
Phone: +84-243-202-2585

## THAILAND

### Makita Manufacturing (Thailand) Co., Ltd.

219/1 Moo 6, Tambol Bowin, Amphur Sriracha, Chonburi, 20230  
Phone: +66-3300-4750  
Fax: +66-3300-4747

## MALAYSIA

### Makita Power Tools (Malaysia) Sdn. Bhd.

#### Head Office

Lot 824, Jalan Subang 5, Subang Industrial Area, 47500 Subang Jaya, Selangor, Malaysia  
Phone: +60-(0)3-8023-0824  
Fax: +60-(0)3-8022-1448

### Johor(Johor Bahru) Service Center

No. 12 & 14, Jalan Rosmerah 2/9, Taman Johor Jaya, 81100 Johor Bahru, Johor  
Phone: +60-(0)7-364-9406  
Fax: +60-(0)7-364-9407

### Sarawak(Kuching) Service Center

Lot 1227, Lorong Demak Indah 2A, Demak Laut Industrial Area, Phase 2A, 93050 Kuching Sarawak, Malaysia.  
Phone: +60-(0)82-496-800  
Fax: +60(0)82-496-900

### Sabah(Kota Kinabalu) Service Center

Lot 19, Jalan Buah Duku, Kolombong Light Industrial Estate, Off Kolombong, Kolombong Zone 1, 88450 Inanam, Kota Kinabalu, Sabah  
Phone: +60-(0)88-388-278  
Fax: +60-(0)88-388 279

## AMERICAS

## UNITED STATES

### Makita U.S.A. Inc.

#### Corporate office

14930 Northam Street, La Mirada, CA 90638-5753, USA  
Phone: +1-714-522-8088  
Fax: +1-714-522-8133  
www.makitatools.com

#### Western regional (Los Angeles) office

14930 Northam Street, La Mirada, CA 90638-5753  
Phone: +1-714-522-8088  
Fax: +1-714-297-1544

#### Western regional (Reno) office

10200 Military Rd, Reno, NV, 89506  
Phone: +1-775-437-9362

#### Central regional (Chicago) office

1450 Feehanville Drive, Mount Prospect, IL 60056-6011  
Phone: +1-847-297-3100  
Fax: +1-847-297-1544

#### Eastern regional (Atlanta) office

4200 Falcon Parkway Flowery Branch, GA 30542  
Phone: +1-770-476-8911  
Fax: 866-521-3541 Free Dial USA only

#### Southern regional (Dallas) office

910 E. Pleasant Run Road, Wilmer, TX 75172  
Phone: +1-972-441-8099  
Fax: +1-855-231-0468

#### Factory service centers

Atlanta, Boston, Chicago, Dallas, Denver, Florida, Houston, Las Vegas, Los Angeles, New Jersey, Portland, San Francisco, Reno

### Makita Corporation of America

2650 Buford Highway, Buford, GA 30518-6045  
Phone: +1-770-932-2901  
Fax: +1-770-932-2905

### Makita Latin America Inc.

#### Head office

9221 West 44th Ave. Suite 900, Hialeah, FL 33018  
Phone: +1-305-882-0522  
Fax: +1-305-882-0484  
www.makitalatinamerica.com

#### Panama Branch

Local Comercial No.4, Albrook Office Center, calle Diego Dominguez, Albrook, Panama City, Panama  
Phone: +507-315-0305  
Fax: +507-315-0651

## CANADA

### Makita Canada Inc.

#### Head office

1950 Forbes Street, Whitby, ON L1N 7B7  
Phone: +1-905-571-2200  
Fax: +1-905-433-4779  
www.makita.ca

#### Western regional office

11771 Hammersmith Way, Richmond, BC V7A 5H6  
Phone: +1-604-272-3104  
Fax: +1-604-272-5416

#### Factory service centers

Burnaby(Vancouver), Calgary, Dartmouth(Halifax), Edmonton, Les Saules(Quebec City), London, Mississauga(Toronto), Nepean(Ottawa), Richmond(Vancouver), Saskatoon, St. Leonard(Montreal), Whitby, Winnipeg

## MEXICO

### Makita México, S.A. de C.V.

#### Head office

Camino Viejo A San Lorenzo Tepaltitlan (Jose Marti) No.227 Col. Tlacopa, Toluca, Estado De Mexico, C.P. 50010  
Phone: +52-722-385-8800 / 237-3293  
www.makita.com.mx

#### Mexico city factory service center

Norte 35 #780-C Col. Industrial Vallejo, Del. Azcapotzalco Mexico, D.F. Mexico C.P. 02300  
Phone: +52-55-5567-3387 / 5368-2937

#### Guadalajara factory service center

AV.Sierra Mazamitla #5864 Col.Pinar De La Calma Zapopan, Jalisco C.P. 45080  
Phone: +52-33-3632-8032 / 3632-8057

#### Monterrey factory service center

Avenida Pablo Livas #4207 Colonia Guadalupe victoria, Municipio Guadalupe nuevo León, C.P.67180  
Phone: +52-81-8372-4205 / 8372-4193

## BRAZIL

### Makita do Brasil Ferramentas Elétricas Ltda.

#### Head office & plant

Rodovia BR 376, Km 506,1 - (pista norte) Bairro Colônia Dona Luiza, CEP 84043-450 - Ponta Grossa, PR  
Phone: +55-(0)42-3302-2100  
Fax: +55-(0)42-3302-2120  
www.makita.com.br

#### São Paulo sales office (MBR)

Rua Makita Brasil, 200 -Bairro Cooperativa - São Bernardo do Campo - SP CEP 09852-080  
Phone: +55-(0)11-4392-2411 / 2199-2500  
Fax: +55-(0)11-4392-2471

#### Bahia sales branch

Rua Itagi, 491 - Bairro Pitangueiras - Lauro de Freitas, BA CEP: 42701-370  
Phone: +55-(0)71-3252-0154

#### Critiba service center

Rua Comendador Roseira, 499 Bairro Prado Velho, Curitiba, PR CEP 80215-210  
Phone: +55-(0)41-3333-8070

#### Rio de Janeiro service center

Av. Das Américas, 2250 - Loja J/K - Barra da Tijuca - Rio de Janeiro, RJ CEP:22640-101  
Phone: +55-(0)21-3151-7933

#### Recife service center

Av. Marechal Mascarenhas de Morais, 630, Bairro Imbiribeira, Recife, PE CEP 51170-000  
Phone: +55-(0)81-3428-0210

#### Belo Horizonte service center

Rua Juiz de Fora, 95 - Bairro Barro Preto, Belo Horizonte, MG CEP 30180-060  
Phone: +55-(0)31-2531-2017

#### Pará Sales Branch

Rodovia BR 316, Km 04 Loja 04-Bairro Águas Lindas,Ananindeua / PA CEP 67020-000  
Phone: +55-(0)91-3237-7186

#### Porto Alegre service center

Av. Sertorio , 5539 - JD. Lindoia - Porto Alegre - RS CEP: 91050-371  
Phone: +55-(0)51-3344-1464

#### Guaxupé service center

Av. Paulo Ribeiro do Valé, 1539 - Japy, Guaxupe - MG, CEP 37800-000  
Phone: +55-(0)35-3551-2825

## ARGENTINA

### Makita Herramientas Eléctricas de Argentina S.A.

LISANDRO DE LA TORRE 1246, PARQUE INDUSTRIAL PILARICA, FATIMA, PILAR PROVINCIA DE BUENOS AIRES, CP1629  
Phone: +54 (230)444-1100  
Fax: +54 (230)444-1105  
www.makita.com.ar

## CHILE

### Makita Chile Comercial Ltda.

#### Head Office

AV.EL PARQUE 1307,PARQUE 5,MODULO 12, SECTOR ENEA PONIENTE PUDAHUEL, SANTIAGO,CHILE CP9031244  
Phone: +56-2-2540-0400  
www.makita.cl

#### Temuco factory service center

Av. Pedro de Valdivia #0524 , Local 13 y 14, Temuco  
Phone: +56-2-2540-0460

#### Antofagasta factory service center

Pedro Aguirre Cerda 6259, local 3, Antofagasta  
Phone: +56-2-2540-0470

## PERU

### Makita Peru S.A.

Panamericana Sur - Km. 29, Distrito de Lurin, Provincia de Lima Centro de Operaciones "MEGACENTRO LURIN" Locales B1, B23, B24  
Phone: +51-(1)-713-1212  
www.makita.pe

#### Bolivia Branch

Av. Japón Nro. 3340 (3er. Anillo externo) entre Av. Alemana y Mutualista  
Phone: +59-(1)-3347-1147

## COLOMBIA

### MAKITA COLOMBIA S.A.S

#### Head Office

Bodega 3 Lote 123, Centro Empresarial Celta Trade Park, Kilometro 7 Autopista Bogotá-Medellín Funza, Cundinamarca, Colombia  
Phone: +57-601-742-9245  
www.makita.com.co

#### Paloquemao factory service center

Carrera 22#18-63, Bogota, Cundinamarca, Colombia  
Phone: +57-601-742-9245 EXT.532

# EUROPE

## UNITED KINGDOM

### Makita (U.K.) Ltd.

#### Head office

Michigan Drive, Tongwell, Milton Keynes, Bucks MK15 8JD  
Phone: +44-(0)1908-211678  
Fax: +44-(0)1908-211400  
www.makita.uk.com

#### Wigan Warehouse

Challenge Way, Martland Park, Wigan, WN5 0LD  
Phone: +44-(0)1908-211678  
Fax: +44-(0)1908-211400

#### Scotland factory service center

Unit 4A, Albion Trading Estate, 750 South Street, Glasgow, G14 0SY  
Phone: +44-(0)141-9545861

#### London factory service center

V5 Vector Park, Forest Road, Feltham, Middlesex, TW13 7EJ  
Phone: +44-(0)20-88900586

#### Makita Manufacturing Europe Ltd.

Hortonwood 7, Telford, Shropshire TF1 7YX  
Phone: +44-(0)1952-677688  
Fax: +44-(0)1952-677678

## FRANCE

### Makita France SAS

#### Head office

37, avenue Graham Bell, ZAC Léonard de Vinci, Bussy Saint-Georges, 77607 Marne-la-Vallée Cedex 3  
Phone: +33-(0)1-6094-6400  
Fax: +33-(0)1-6094-6380  
www.makita.fr

#### Nantes office

Le Pan Loup, 44220 Couéron  
Phone: +33-(0)2-5177-8977  
Fax: +33-(0)2-4063-8376

#### Bordeaux office

137, Rue de la Croix-de-Monjeux, 33170 Gradignan  
Phone: +33-(0)5-5796-5270  
Fax: +33-(0)5-5796-5275

#### Nord office

Village d'Entreprises, 51, Rue Trémière, 59650 Villeneuve d'Ascq  
Phone: +33-(0)3-2059-7020  
Fax: +33-(0)3-2047-2220

#### Dijon office

5, Rue Edmond Voisenet, 21000 Dijon  
Phone: +33-(0)3-8054-0880  
Fax: +33-(0)3-8054-0881

#### Lyon office

29 rue Antoine Condorcet, 38090 Villefontaine  
Phone: +33-(0)7-8563-8049  
Fax: +33-(0)1-60-94-63-86

#### Toulouse office

15, Rue de Boudeville, Z.I. de Thibaud, 31104 Toulouse  
Phone: +33-(0)5-6143-2200  
Fax: +33-(0)5-6143-2201

## SPAIN

### Makita, S.A.

#### Head office

C/ Juan de la Cierva, 7-15, 28823 Coslada (Madrid)  
Phone: +34-91-671-1262  
Fax: +34-91-671-8293  
www.makita.es

#### Barcelona Office

Sector ind. La Post c/ Barcelona 3-5 08850 Gavá(Barcelona)  
Phone: +34-935-669-124

## PORTUGAL

### Makita - Ferramentas Electricas, Sociedade Unipessoal, Lda.

#### portugal sales division

Centro empresarial de Alverca, Vale das Ervas, Armazém C2 2615-187 Alverca do Ribatejo  
Phone: +351-219-936-750  
Fax: +351-219-574-982  
www.makita.pt

## ITALY

### Makita S.p.A.

Via Don Luigi Sturzo 56/58, Arluno, 20004, Milano, Italy  
Phone: +39-0331-524111  
Fax: +39-0331-420285  
www.makita.itz

## GREECE

### Makita Hellas S.A.

Tatoiou 34, Acharnes, ATTIKI PC13677  
Phone: +30-210-8071241  
Fax: +30-210-8072245  
www.makita.gr

## FINLAND

### Makita Oy

Teilimäki 4 FIN-01530 Vantaa, Finland  
Phone: +358-(0)9-8578-830  
Fax: +358-(0)9-857-88211  
www.makita.fi

#### FSC

Krouvintie 5 90400 Oulu, Finland  
Phone: +358 (0)8 -237-48930

## ESTONIA

### Makita Oy Estonian Branch

**Estonian office**  
Piirimäe 13, 76406 Saku vald, Harjumaa maakond  
Phone: +372-6-510-380  
Fax: +372-6-510-399  
www.makita.ee

## LATVIAN

### Makita OY Latvian Branch

#### Latvian factory service center

Vienības gatve 153/1, Mārupes Mārupes nov., LV-2167, LATVIA  
Phone: +371 6796 9564  
Fax: +371 6796 9564  
www.makita.lv

## LITHUANIAN

### Makita OY Lithuanian Branch

#### Lithuanian factory service center

L. Zamenhofo Str. 3, Vilnius, LT-06332, LITHUANIA  
Phone: +370 5 236 0400  
Fax: +370 5 236 0407  
www.makita.lt

## SWEDEN

### Makita Sweden

Bergkällavägen 36A 192 79 SOLLENTUNA SWEDEN  
Phone: +46-8-505-819-00  
Fax: +46-8-505-819-69  
www.makita.se

## NORWAY

### Makita Norway

Loxaveien 15 1351 Rud Norway  
Phone: +47-67 17 69 00  
Fax: +47 67 17 69 01  
www.makita.no

## THE NETHERLANDS

### Makita Nederland B.V.

#### Head office

Park Forum 1101 5657HK Eindhoven  
Phone: +31-(0)40-206-4040  
Fax: +31-(0)40-206-4096  
www.makita.nl

#### Utrecht Service Center

Straat van Gibraltar 6, 3446CM Woerden  
Phone: +31-(0)40-206-4040  
Fax: +31-(0)40-206-4096

## BELGIUM

### S.A. Makita N.V.

Jan-Baptist Vinkstraat 2 3070 Kortenberg  
Phone: +32-(0)2-257-1840  
Fax: +32-(0)2-253-0101  
www.makita.be

#### Antwerp

Makita FSC Boom Industrierweg 1C 2850 Boom  
Phone: +32-(0)2-257-1840

#### Charleroi Service Center

Avenue de Heppignies 6 6220 Fleurus

## GERMANY

### Makita Werkzeug GmbH

#### Head office

Makita Platz 1, 40885 Ratingen  
Phone: +49 (0)2102 1004-0  
Fax: +49 (0) 2102 1004-128  
www.makita.de www.dolmar.de/

#### Makita Service Center Hamburg

Jenfelder Strasse 51, 22045 Hamburg  
Phone: +49 (0) 2102 1004-456  
Fax: +49 (0) 2102 1004-493

#### Makita Service Center Berlin

Gartenfelder Strasse 29 – 37 Gebäude 44, 13599 Berlin  
Phone: +49 (0)30 339 756 50

#### Makita Service Center Lehrte

Everner Strasse 30, 31275 Lehrte  
Phone: +49 (0)5132 5042153  
Fax: +49 (0)2102 1004475  
www.makita.de

#### Makita Service-Center Groß-Gerau

Hans-Böckler-Str. 22 64521 Groß-Gerau  
Phone: +49 (0)6152 9788500  
www.makita.de

#### Makita Logistics Center South Germany

Baumschulenstrasse 1B, 93083 Obertraubling  
Phone: +49 (0)2102 1004-410  
www.makita.de

#### Makita Engineering Germany GmbH

Jenfelder Strasse 38, 22045 Hamburg  
Phone: +49-(0)40-66986-0  
Fax: +49-(0)40-66986-352  
www.makita-engineering.de

## DENMARK

### Makita Elværktojs Danmark

#### Denmark office

Vegavej 17, 8700 Horsens, Denmark  
Phone: +45-76-254400  
www.makita.dk

## SWITZERLAND

### Makita SA

#### Chemin du Vuasset 7 CH-1028

Preverenges  
Phone: +41-(0)21-811-5656  
Fax: +41-(0)21-811-5678  
www.makita.ch

#### Space Mittelland Training Service Center

Lerchenweg 14 CH-4538 Oberbipp  
Phone: +41-(0)32 631 01 76  
Fax: +41-(0)32 631 01 79

## AUSTRIA

### Makita Werkzeug Gesellschaft m.b.H.

Airportstraße 4, A-2401 Fischamend  
Phone: +43-(0)2232-77700-0  
Fax: +43-(0)2232-77700-13  
www.makita.at

## SLOVENIA

### MAKITA.d.o.o.

Brnčičeva 17, SI-1231 Ljubljana-Črnuče, Slovenia  
Phone: +386(0) 590 83 600  
Fax: +386(0) 590 83 601  
www.makita-see.com

## CROATIA

### Croatia factory service center

Kreše Golika 3A, HR- 10000 Zagreb  
Phone: +385 1 2078 252  
www.makita-see.com

## UKRAINE

### Makita Ukraine LLC

61 Oleha Onikiyenka Str., Brovary, Kyiv region 07400, Ukraine  
Phone: +38 (044) 494-23-70  
+38 (044) 494-23-71  
Fax: +38 (044) 494-23-73  
www.makita.ua

#### Dnipro FSC

5 Kursanta Ckorobogatka Str., Dnipro, Dnipropetrovsk region 49124, Ukraine  
Phone: +380 (44) 492-27-73

## POLAND

### Makita Sp. z o.o.

#### Head office

ul. Bestwińska 103 43-346 Bielsko - Biala  
Phone: +48-(0)33-484-0200  
Fax: +48-(0)33-818-4059  
www.makita.pl

#### Warsaw branch

Moszna-Parcela 29 05-840 Brwinów  
Phone: +48-(0)22-177-7300

## CZECH REPUBLIC

### Makita, spol. s r.o.

Kaštanová 555/125d 620 00 Brno  
Phone: +42-(0)5-432-16944  
Fax: +42-(0)5-432-16946  
www.makita.cz

#### Prague Service Center

K Bílému Vrchu 3040/16, 193 00 Prague 9  
Phone: +42-(0)2-991-40585

## SLOVAKIA

### Makita s.r.o.

Priemyselná 26 974 01 Banská Bystrica  
Phone: +421-(0)48-4161-772  
Fax: +421-(0)48-4161-769  
www.makita.sk

## HUNGARY

### Makita Elektromos Kiszgépértékesítő Kft.

8000 Székesfehérvár, Kukorica utca 7.  
Phone: +36-22-507-472  
Fax: +36-22-507-484  
www.makita.hu

## MIDDLE EAST/ AFRICA

### ROMANIA

#### Makita Romania S.R.L.

Str. I.C.Bratianu nr. 164 Depozit Faza 3  
077030 Comuna Branesti jud. Ilfov  
Romania  
Phone: +40 21 569 80 61  
+40 21 569 80 62  
Fax: +40 21 569 80 59  
www.makita.ro

#### Cluj-Napoca Factory Service Center

Str. Bld. Muncii, Nr. 68, 400641  
Cluj, Romania  
Phone: +40 21 569 80 61

#### Iasi Factory Service Center

Boulevard Poitiers No. 2, 700671  
Iasi, Romania  
Phone: +40 21 569 80 61

#### SC Makita EU SRL

Str. I.C. Bratianu, nr. 164, Comuna Branesti,  
jud. ILFOV, ROMANIA 077030  
Phone: +40-21-310-7675  
Fax: +40-21- 200-0219

### BULGARIA

#### Makita Bulgaria EOOD

Okolovrasten Pat (circle road), No.373,  
Sofia 1186, Bulgaria  
Phone: +359-2-921-0551  
Fax: +359-2-921-0550  
www.makita.bg

### RUSSIA

#### Makita LLC

Krasnoproletarskaya street, 4, 1F  
Entrance3 ,Moscow 127006  
Phone: +7 (495) 109-88-66

#### MAKITA LLC, Vladivostok branch

83, 1st RABOCHAYA str. ARTEM 692770,  
RUSSIA  
Phone: +7(423)202-65-23

#### MAKITA LLC, Novosibirsk branch

15, Dargomyzhskogo str., Novosibirsk,  
Russia, 630047  
Phone: +7 (383) 209 18 19  
Fax: +7 (383) 209 18 19

#### MAKITA LLC, Samara Branch

3 Mirnaya str., Samara, Russia, 443035  
Phone: +7 (846) 202 90 50  
+7 (846) 202 42 83

#### MAKITA LLC, Krasnodar branch

32/2, Turgenevskoe, Takhtamukaisky  
district, Adygea Republic, Russia, 385132  
Phone: +7 (861) 238 24 97

#### MAKITA LLC, Yekaterinburg Branch

5, pereulok Avtomatiki, Yekaterinburg,  
Russia, 620049  
Phone: +7 (343) 286 00 09

### BELARUS

#### MAKITA LLC, Belarus Branch

"Green Plaza", 10a, Biruzova str., Minsk,  
220073, Belarus  
Phone: +375 17 337 1111  
www.makita.by

### GEORGIA

#### LTD «Makita Georgia»

64, D. Guramishvili avenue, 0141, Tbilisi,  
Georgia  
Phone: +995 032 243 06 43

### KAZAKHSTAN

#### Makita Kazakhstan LLP

Kommunalnaya 39, 050016, Almaty,  
Kazakhstan  
Phone: +7 727 233 0827  
Fax: +7 727 382 7921

### UNITED ARAB EMIRATES

#### Makita Gulf FZE

P.O. Box 17133,  
Jebel Ali Free Zone, Dubai, UAE  
Phone: +971-(0)4-8860-804  
Fax: +971-(0)4-8860-805  
www.makita.ae

### TANZANIA

#### MAKITA AFRICA LIMITED

P.O. Box 20998,  
2nd Floor, Staywell Office Building, Haile  
Selassie Road, Mwasani Peninsula, Dar es  
Salaam, Tanzania  
Phone: +255 22 2602870

### MOROCCO

#### MAKITA MOROCCO SARL

Rte Zenata Lot Marhaba Show Room N5  
Espace Commercial Asteria Amal 5 A S,  
20250 Casablanca, Morocco  
Phone: +212 522 344808  
Fax: + 212 522 355696

## OCEANIA

### AUSTRALIA

#### Makita (Australia) Pty. Ltd.

##### Head office

2 Litton Close Pemulwuy. NSW. 2145  
Phone: +61 1300 361 690  
Fax: +61 1300 361 770  
www.makita.com.au

##### Hobart office

32a Chapel Street Glenorchy, TAS 7010  
Phone: +61 1300 361 690  
Fax: +61 1300 361 770

##### Perth office

374A Kenwick Rd Maddington WA 6109  
Phone: +61 1300 361 690  
Fax: +61 1300 361 770

##### Factory Service Center

Sydney, Melbourne, Brisbane, Perth,  
Hobart, Townsville

### NEW ZEALAND

#### Makita (New Zealand) Ltd.

##### Head office

46 Westpoint Drive, Hobsonville,  
Auckland 0618  
Phone: +64-(0)9-479-8251  
Fax: +64-(0)9-479-8259  
www.makita.co.nz

##### Christchurch Office

Unit10, 11, 8 Islington Ave, Christchurch  
,8042  
Phone: +64-(0)3-930-0500

##### Factory Service Center

Auckland, Christchurch, Wellington

## Safety Precautions

When using electric tools, basic safety precautions should always be followed to reduce the risk of fire, electric shock, and personal injury, including the following.

### /// KEEP WORK AREA CLEAN.

Cluttered areas and benches invite injuries.

### /// CONSIDER WORK AREA ENVIRONMENT.

Don't use power tools in damp or wet locations. Keep work area well lit. Don't expose power tools to rain. Don't use power tool in presence of flammable liquids or gases.

### /// KEEP CHILDREN AWAY.

All visitors should be kept away from work area. Don't let visitors touch the tool or extension cord.

### /// STORE IDLE TOOLS.

When not in use, tools should be stored in a dry, high of locked up place, out of reach of children.

### /// DON'T FORCE THE TOOL.

It will do the job better and safer at the rate for which it was intended.

### /// USE THE RIGHT TOOL.

Don't force small tools or attachments to do the job of a heavy-duty tool. Don't use tools for purposes not intended.

### /// DRESS PROPERLY.

Don't wear loose clothing or jewelry. They can be caught in moving parts. Rubber gloves and non-skid footwear are recommended when working outdoors. Wear protective hair covering to contain long hair.

### /// USE SAFETY GLASSES.

Also use face or dust mask if the cutting operation is dusty.

### /// DON'T ABUSE THE CORD.

Never carry the tool by the cord or yank it to disconnect it from the socket. Keep the cord away from heat, oil, and sharp edges.

### /// SECURE WORK.

Use clamps or a vise to hold the work. It's safer than using your hand and it frees both hands to operate the tool.

### /// DON'T OVERREACH.

Keep proper footing and balance at all times.

### /// MAINTAIN TOOLS WITH CARE.

Keep cutting tools sharp and clean for better and safer performance. Follow instructions for lubrication and changing accessories. Inspect tool cord periodically and if damaged, have it repaired by an authorized service facility. Inspect extension cords periodically and replace, if damaged. Keep handles dry, clean and free from oil and grease.

### /// DISCONNECT TOOLS.

When not in use, before servicing and when changing accessories such as blades, bits and cutters.

### /// REMOVE ADJUSTING KEYS AND WRENCHES.

Form the habit of checking to see that keys and adjusting wrenches are removed from the tool before turning it on.

### /// AVOID UNINTENTIONAL STARTING.

Don't carry a plugged-in tool with a finger on the switch. Ensure switch is OFF when plugging in.

### /// USE OUTDOOR EXTENSION CORDS.

When tool is used outdoors, use only extension cords intended for outdoor use.

### /// STAY ALERT.

Watch what you are doing. Use common sense. Don't operate tool when you are tired.

### /// CHECK DAMAGED PARTS.

Before further use of the tool, a guard or other part that is damaged should be carefully checked to determine that it will operate properly and perform its intended function. Check for alignment of moving parts, free running of moving parts, breakage of parts, mounting and any other conditions that may affect its operation. A guard or other part that is damaged should be properly repaired or replaced by an authorized service center unless otherwise indicated in this instruction manual. Have defective switches replaced by an authorized service facility. Don't use the tool if the switch does not turn it on and off.

### /// GUARD AGAINST ELECTRIC SHOCK.

Avoid body contact with earthed or grounded surfaces (e.g. pipes, radiators, ranges, refrigerators).

### /// REPLACEMENT PARTS.

When servicing a tool, use only identical replacement parts.

### /// VOLTAGE WARNING:

Before connecting the tool to a power source (receptacle, outlet, etc.) Be sure the voltage supplied is the same as that specified on the nameplate of the tool. A power source with voltage greater than that specified for the tool can result in SERIOUS INJURY to the user V as well as damage to the tool. If in doubt, DO NOT PLUG IN THE TOOL. Using a power source with voltage less than the nameplate rating is harmful to the motor.

## Note

- Makita reserves the right to change specifications of parts and accessories without notice.
- Items of standard equipment and specifications may vary by country or area.
- Net weight and dimensions may differ by the type of battery.
- Standard export color for motor housing is Makita industrial green (blue).
- Please state required voltage when ordering. These offers are subject to availability in each country. Actual product color may differ slightly from color reproduced here.
- Weight data in this catalogue is the value measured by us according to EPTA Procedure.

## Guarantee

Every Makita tool is thoroughly inspected and tested before leaving the factory. It is guaranteed against defective workmanship and materials. Should any trouble develop, return the COMPLETE tool prepaid to Makita or point of purchase. If inspection shows trouble is caused by defective workmanship of material, all repairs will be made without charge. The guarantee does not apply where repairs have been made or attempted by others; repairs are due to normal wear; the tool has been abused or in an accident; misuse is evident – caused by overloading the tool beyond its capacity, use of the tool after partial failure or use with improper accessories.

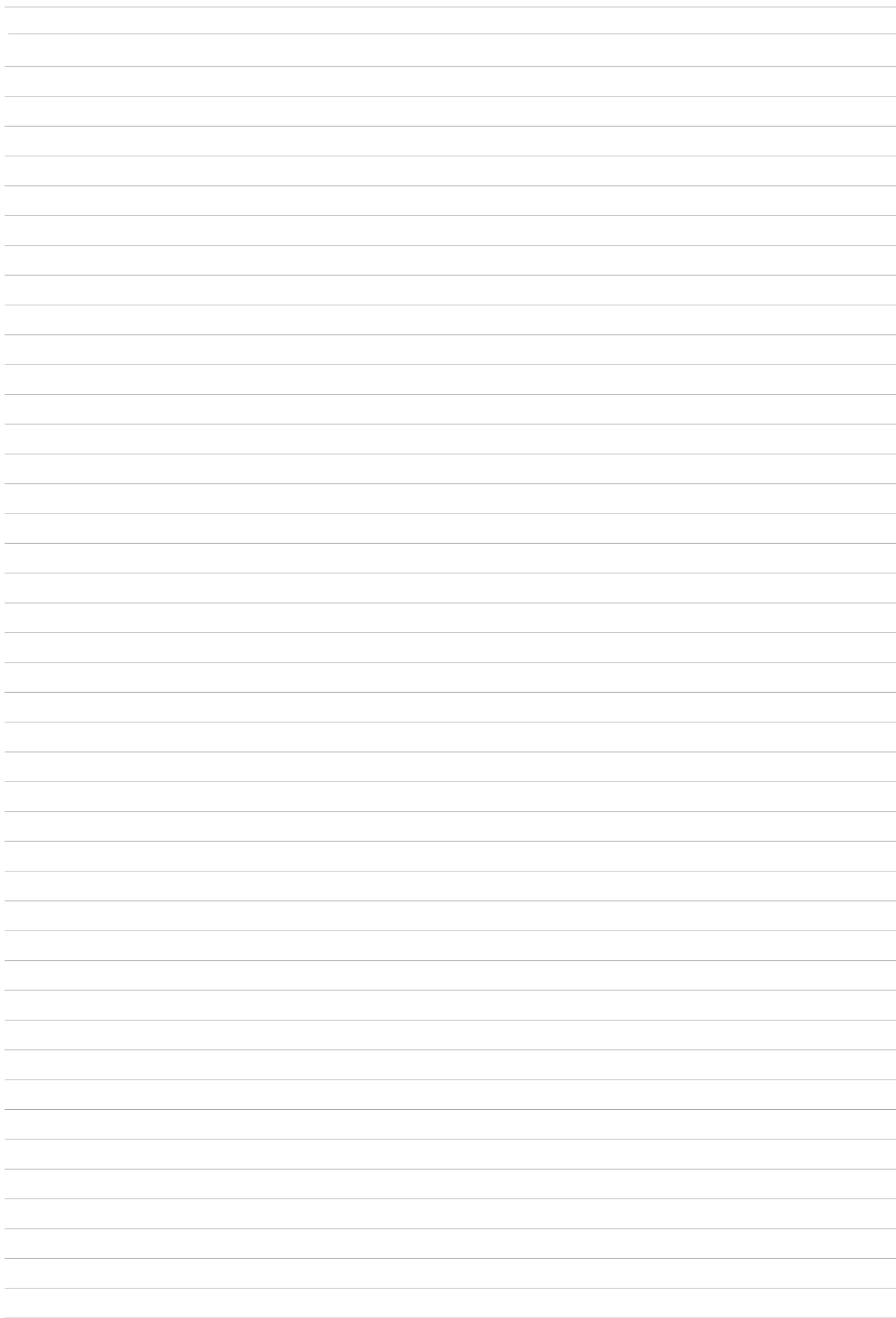

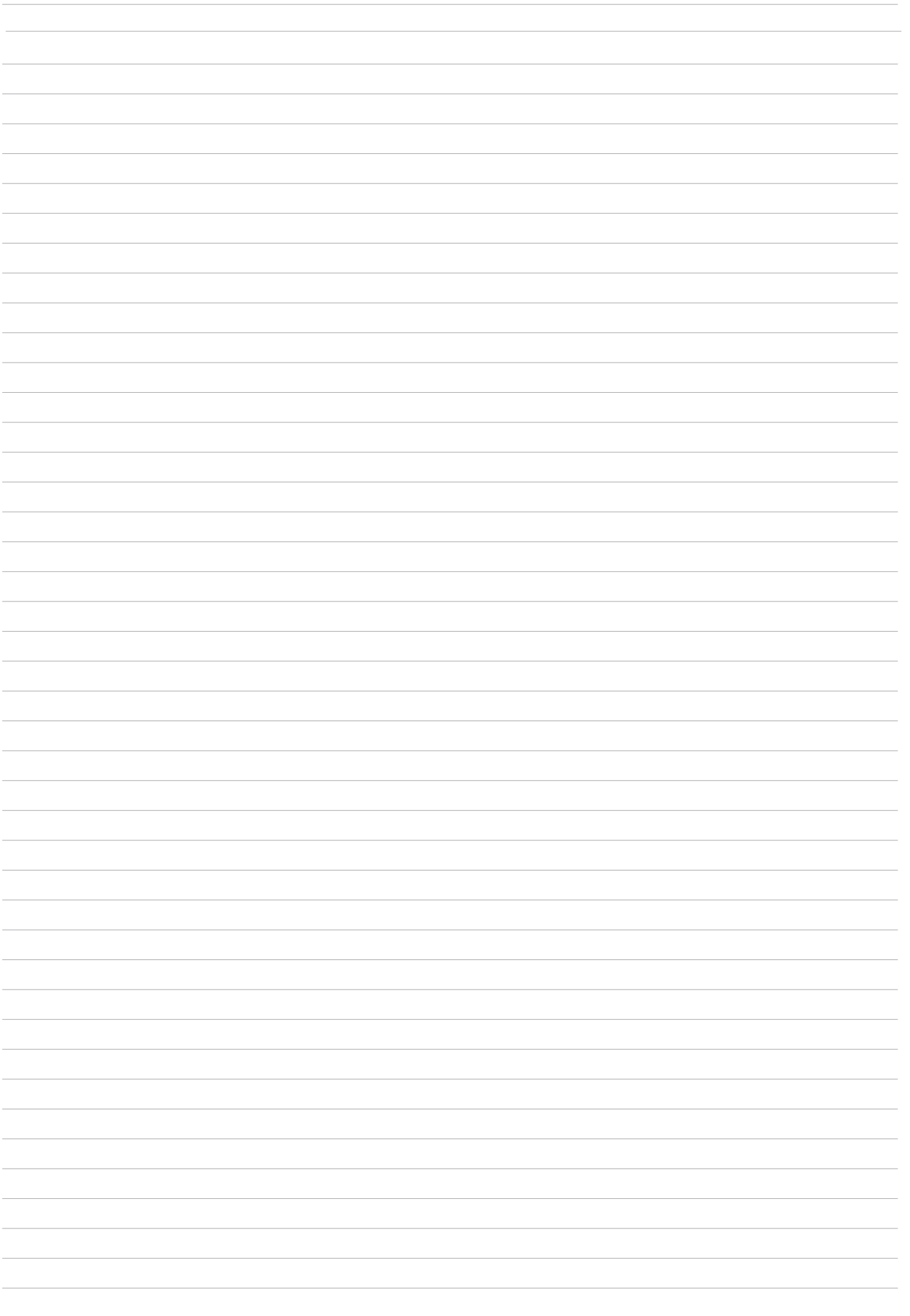

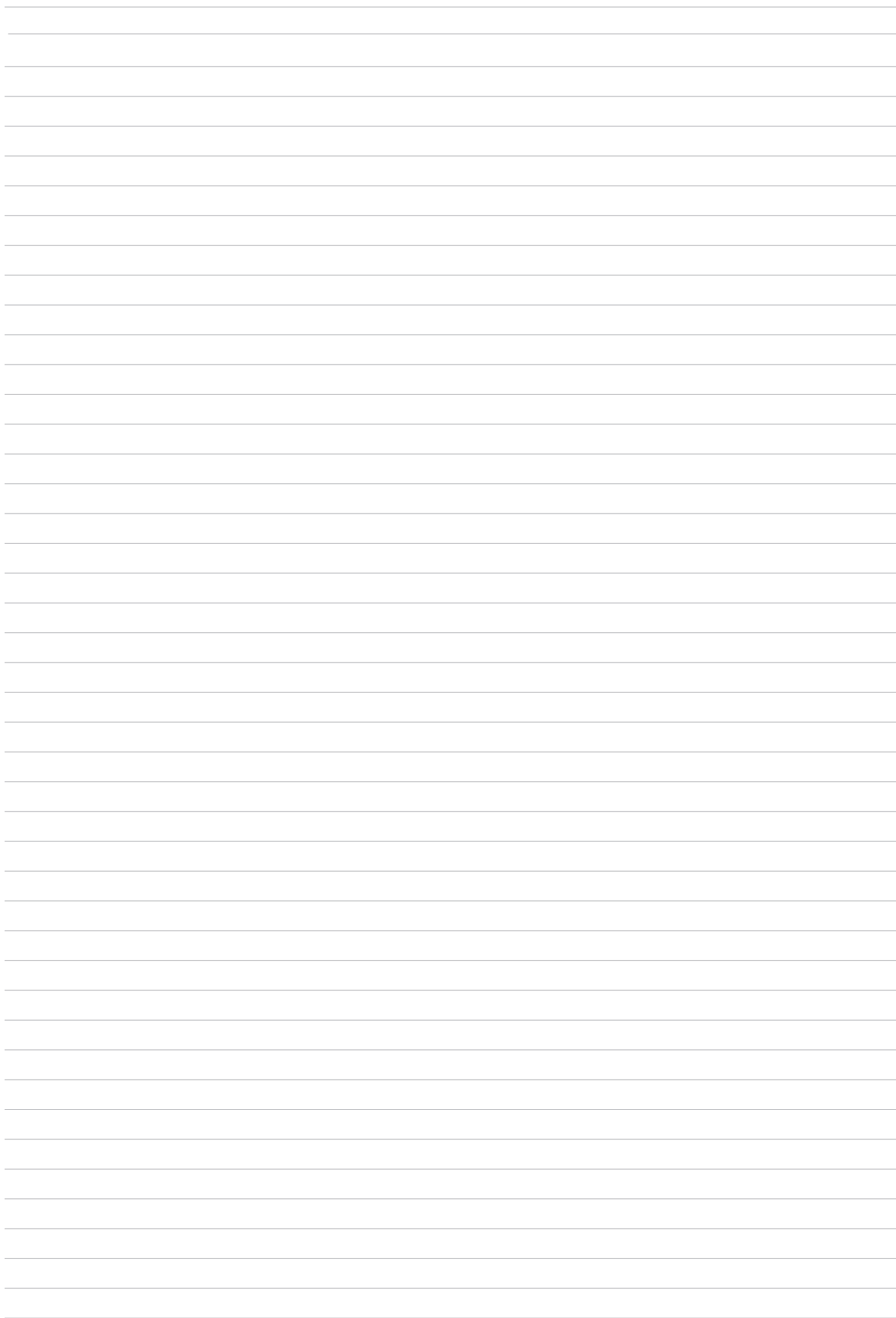



makita.ae

## MAKITA GULF FZE

P.O BOX 17133, JEBEL ALI FREE ZONE, DUBAI, U.A.E.  
TEL. (971) 4 8860804



PART #: (Z) 000013-7  
PRINTED IN U.A.E VZ.23-1

DOWNLOAD  
CATALOGUE