

Model No.UH4570 HEDGE TRIMMER 450MM

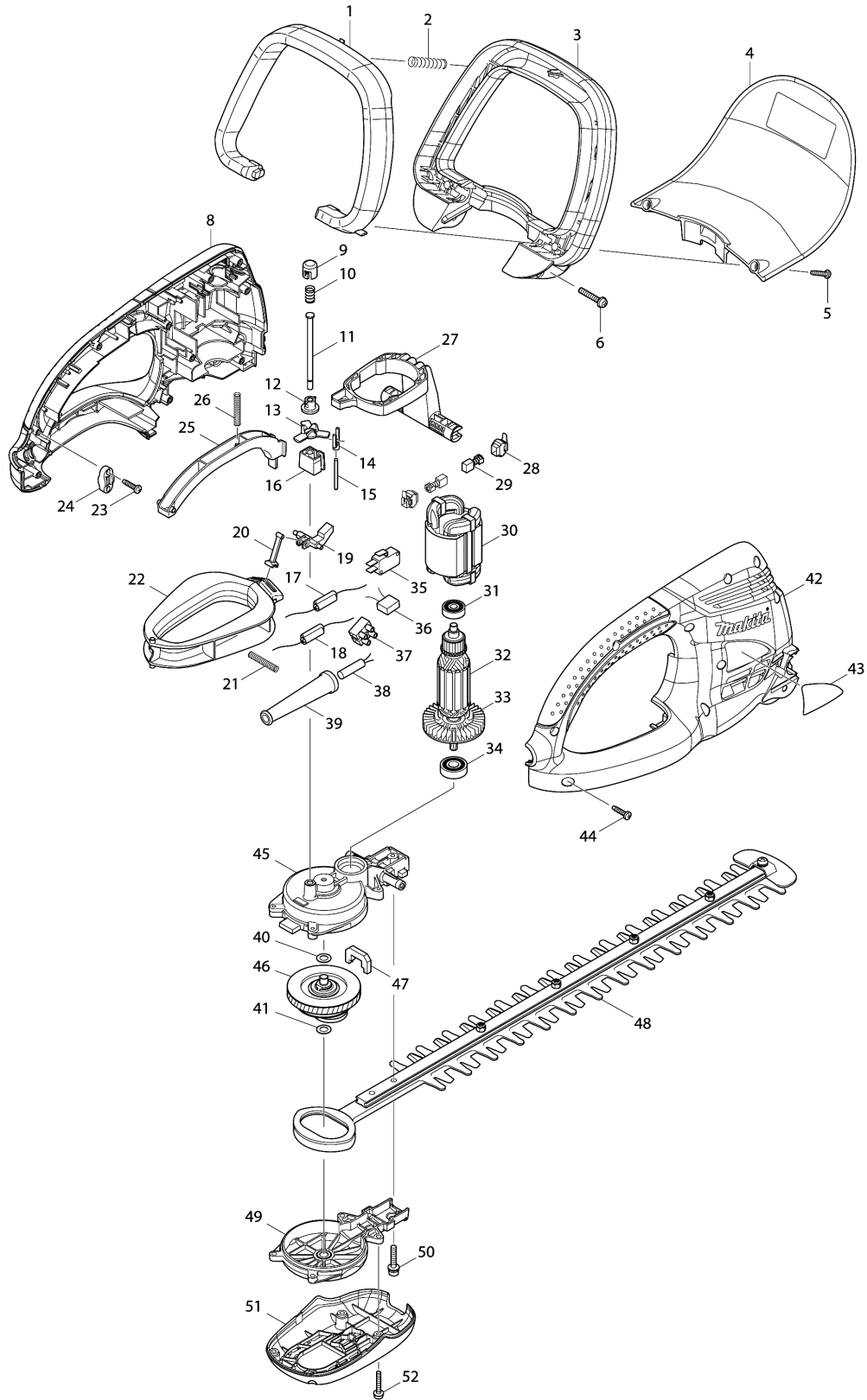

Model No.UH4570 HEDGE TRIMMER 450MM

Item	Parts No.	Description	I/C	Qty	New/Old	Opt. 1	Opt. 2	Note
001	450444-8	SWITCH LEVER B		1				
002	233157-4	COMPRESSION SPRING 9		1				
003	450442-2	FRONT GRIP		1				
004	158629-7	PROTECTOR COMPLETE		1				
005	265995-6	TAPPING SCREW 4X18		2				
006	911253-5	PAN HEAD SCREW M5X30		2				
008	188567-9	HOUSING SET		1				
D10		INC. 42						
009	417740-7	INSULATION CAP		1				
010	233288-9	COMPRESSION SPRING 8		1				
011	268077-3	PIN 5		1				
012	417727-9	CAP HOLDER		1				
013	417736-8	LIFTER		1				
014	417735-0	PUSHER CAP		1				
015	268237-7	ROD 3		1				
016	417781-3	PIN HOLDER		1				
017	646206-2	CHOKE COIL		1				
018	646207-0	CHOKE COIL		1				
019	417737-6	LINK		1				
020	417739-2	ROD		1				
021	233156-6	COMPRESSION SPRING 5		1				
022	417731-8	SWITCH LEVER C		1				
023	265995-6	TAPPING SCREW 4X18		2				
024	687063-9	CORD CLAMP		1				
025	450443-0	SWITCH LEVER A		1				
026	233156-6	COMPRESSION SPRING 5		1				
027	450488-8	LEVER		1				
028	643936-6	BRUSH HOLDER		2				
029	191962-4	CARBON BRUSH CB-419		1				
030	621733-0	FIELD 220-240V		1				
031	211027-7	BALL BEARING 627ZZ		1				
032	515738-9	ARMATURE ASS'Y 220-240V		1				
D10		INC. 31,33,34						
033	241850-6	FAN 60		1				
034	211062-5	BALL BEARING 6000ZZ		1				
035	650608-6	SWITCH D3B6-V1AA		1	*			
035-1	650628-0	SWITCH 1005.1004	<	1				
036	645190-8	NOISE SUPPRESSOR		1				
037	654531-7	TERMINAL BLOCK 2P		1				
038	666246-4	POWER SUPPLY CORD 1.5-2-0.3		1				
039	682503-2	CORD GUARD 8-90		1				
040	253215-0	FLAT WASHER 8		1				

Please order the parts with part number.

Print Date 31/3/2020

Model No.UH4570 HEDGE TRIMMER 450MM

Item	Parts No.	Description	I/C	Qty	New/Old	Opt. 1	Opt. 2	Note
041	253215-0	FLAT WASHER 8		1				
042	188567-9	HOUSING SET		1				
D10		INC. 8						
043	865772-2	UH4570 NAME PLATE		1				
044	265995-6	TAPPING SCREW 4X18		10				
045	158625-5	GEAR HOUSING COMPLETE		1				
046	158623-9	GEAR COMPLETE		1				
047	443142-1	DUST GUARD		1				
048	194660-9	SHEAR BLADE ASS'Y SET		1				
C10	264013-7	HEX. LOCK NUT M5-8		4				
C20	345205-8	BRANCH CATCHER		1				
C30	911208-0	PAN HEAD SCREW M5X10		1				
C40	257766-5	SLEEVE 5		6				
C50	265181-9	+TRUSS HEAD SCREW M5X20		4				
C60	188605-7	OIL VESSEL SET		1				
049	158626-3	GEAR HOUSING COVER COMPLETE		1				
050	265182-7	+ PAN HEAD SCREW M5X25		2				
051	450440-6	UNDER COVER		1				
052	911148-2	PAN HEAD SCREW M4X25		4				
A01	194677-2	CORD HOLDER COMPLETE SET		1				
A02	158024-1	HOOK COMPLETE		1				
A03	450489-6	BLADE COVER		1				

Please order the parts with part number.

Print Date 31/3/2020