

Model No.UH009G 750MM CORDLESS HEDGE TRIMMER

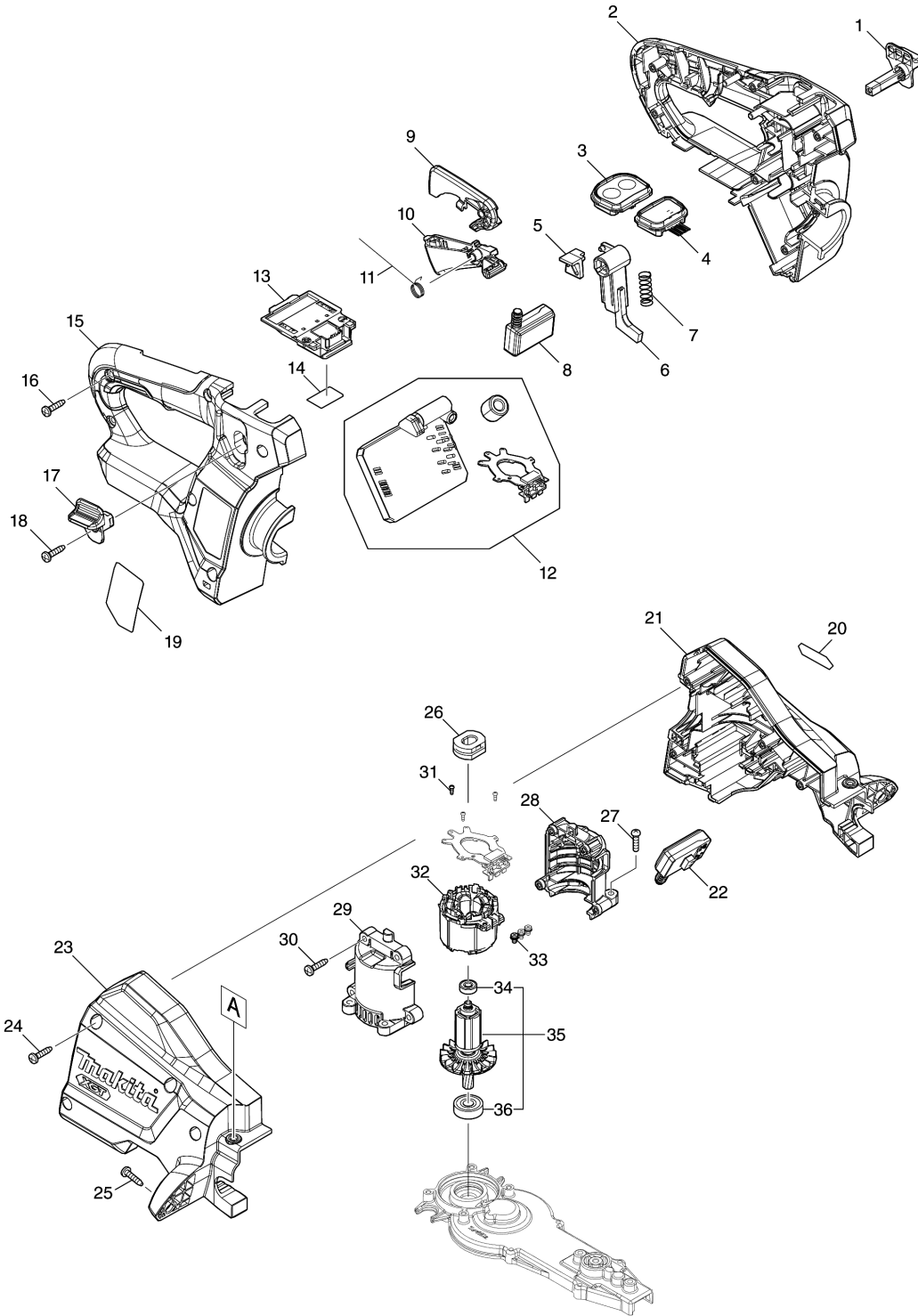

Model No.UH009G 750MM CORDLESS HEDGE TRIMMER

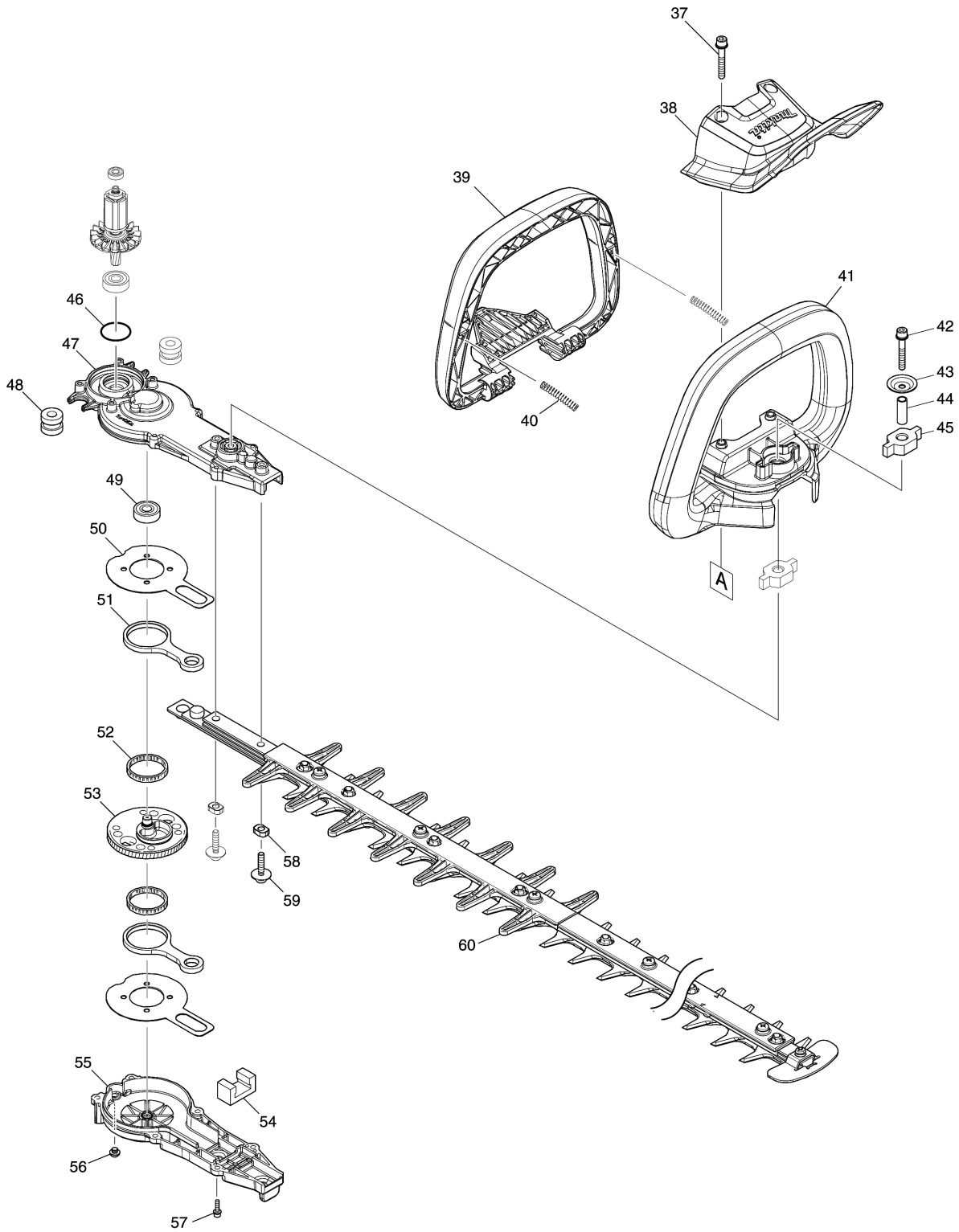

Model No.UH009G 750MM CORDLESS HEDGE TRIMMER

Item	Parts No.	Description	I/C	Qty	New/Old	Opt. 1	Opt. 2	Note
001	458406-0	LOCK LEVER L		1				
002	183T66-6	HANDLE SET		1				
C10	263005-3	RUBBER PIN 6		2				
C20	8034N8-3	CAUTION LABEL		1				
D10		INC. 15						
003	141D66-6	SWITCH CIRCUIT COMPLETE E		1				
C10	8034K3-2	SWITCH LABEL		1				
004	140W63-3	INDICATION CIRCUIT COMPLETE		1				
005	458570-7	SLIDER		1				
006	458405-2	LOCK ARM		1				
007	234204-4	COMPRESSION SPRING 8		1				
008	651083-9	SWITCH C3XA-1PSPM		1				
009	458403-6	LOCK OFF LEVER		1				
010	413792-6	SWITCH LEVER R		1				
011	232454-5	TORSION SPRING 10		1				
012	620E88-0	CONTROLLER		1				
C10	688163-8	LINE FILTER		1				
C20	688164-6	LINE FILTER		1				
013	632P64-8	TERMINAL UNIT		1				
014	811J67-1	UH009G SERIAL NO. LABEL		1				
015	183T66-6	HANDLE SET		1				
C10	263005-3	RUBBER PIN 6		2				
C20	8034N8-3	CAUTION LABEL		1				
D10		INC. 2						
016	266326-2	TAPPING SCREW 4X18		6				
017	458407-8	LOCK LEVER R		1				
018	266326-2	TAPPING SCREW 4X18		1				
019	811J63-9	UH009G NAME PLATE		1				
020	8025F3-0	XGT LOGO LABEL		1				
021	183S95-3	HOUSING SET		1				
C10	424344-8	DAMPER		4				
D10		INC. 23						
022	651083-9	SWITCH C3XA-1PSPM		1				
023	183S95-3	HOUSING SET		1				
C10	424344-8	DAMPER		4				
D10		INC. 21						
024	266326-2	TAPPING SCREW 4X18		4				
025	266326-2	TAPPING SCREW 4X18		2				
026	422261-6	RUBBER SLEEVE		1				
027	911128-8	P.H.SCREW M4X16 WITH WR		4				
028	183S94-5	MOTOR HOUSING SET		1				

Model No.UH009G 750MM CORDLESS HEDGE TRIMMER

Item	Parts No.	Description	I/C	Qty	New/Old	Opt. 1	Opt. 2	Note
D10		INC. 29						
029	183S94-5	MOTOR HOUSING SET		1				
D10		INC. 28						
030	266326-2	TAPPING SCREW 4X18		4				
031	266490-9	TAPPING SCREW PT 2X6		3				
032	629A75-2	STATOR		1				
033	652069-6	FLAT HEAD SCREW M3X6		3				
034	211157-4	BALL BEARING 695ZZ		1				
035	519694-5	ROTOR ASSY		1				
D10		INC. 34,36						
036	210005-4	BALL BEARING 608DDW		1				
037	265182-7	+ PAN HEAD SCREW M5X25		2				
038	458399-1	PROTECTOR		1				
039	458402-8	SWITCH LEVER F		1				
040	233222-9	COMPRESSION SPRING 5		2				
041	413791-8	FRONT GRIP E		1				
042	251476-6	H.S.H.BOLT M5X35 WITH WR		1				
043	253416-0	DISH WASHER 5		1				
044	257678-2	SLEEVE 6		1				
045	422260-8	RUBBER SLEEVE 8		2				
046	213961-7	O RING 22		1				
047	141C41-6	GEAR HOUSING COMPLETE		1				
C10	263002-9	RUBBER PIN 4		1				
C20	424344-8	DAMPER		1				
048	422725-0	RUBBER SLEEVE 8		2				
049	211032-4	BALL BEARING 608ZZ		1				
050	347361-0	FRICITION PLATE		2				
051	347662-6	CONNECTING ROD		2				
052	212229-8	NEEDLE CAGE 315		2				
053	141C40-8	GEAR COMPLETE		1				
054	443159-4	SEAL		1				
055	141C46-6	GEAR HOUSING COVER COMPLETE		1				
056	266559-9	H.S.BUTTON HEAD BOLT M6X4		1				
057	922128-3	HEX. SOCKET HEAD BOLT M4X16		6				
058	257439-0	SLEEVE 5		2				
059	265A89-3	H.S.H.BOLT M5X25 WITH WR		2				
060	191R58-9	SHEAR BLADE 750 S SET		1				
C10	199450-5	GREASE VESSEL SET		1				
C20	412908-0	GUARD E		1				
C30	458629-0	SPACER 750		1				
C40	915211-3	BINDING HEAD SCREW M5X12		6				

Please order the parts with part number.

Print Date 6/5/2021

Model No.UH009G 750MM CORDLESS HEDGE TRIMMER

Item	Parts No.	Description	I/C	Qty	New/Old	Opt. 1	Opt. 2	Note
D10		INC, 58						
A01	459122-7	BLADE COVER 750S		1				
E01	807950-8	SOUND 95DB LABEL		1				

Please order the parts with part number.

Print Date 6/5/2021