

Model No. UC3520A CHAIN SAW 350MM

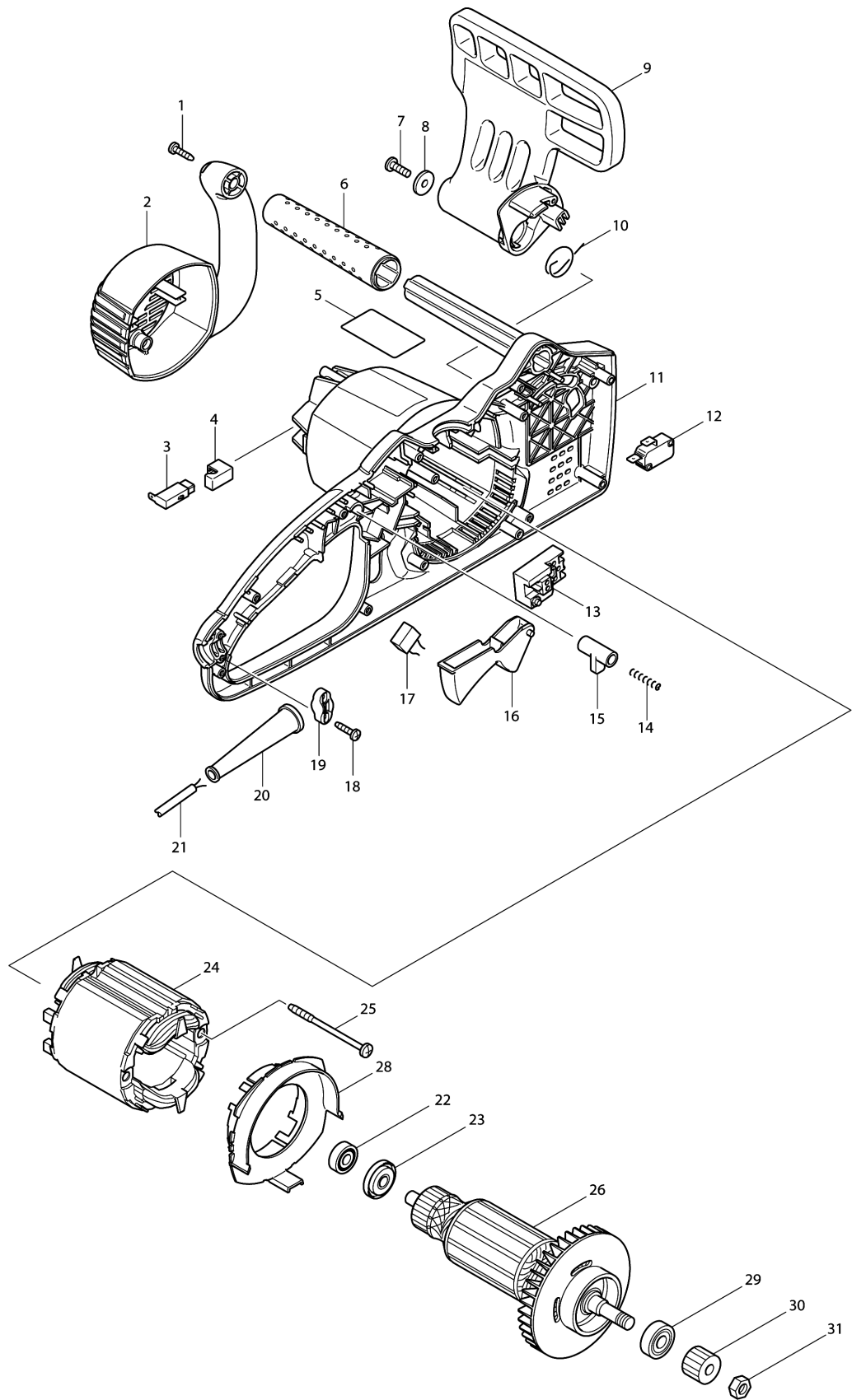

Model No. UC3520A CHAIN SAW 350MM

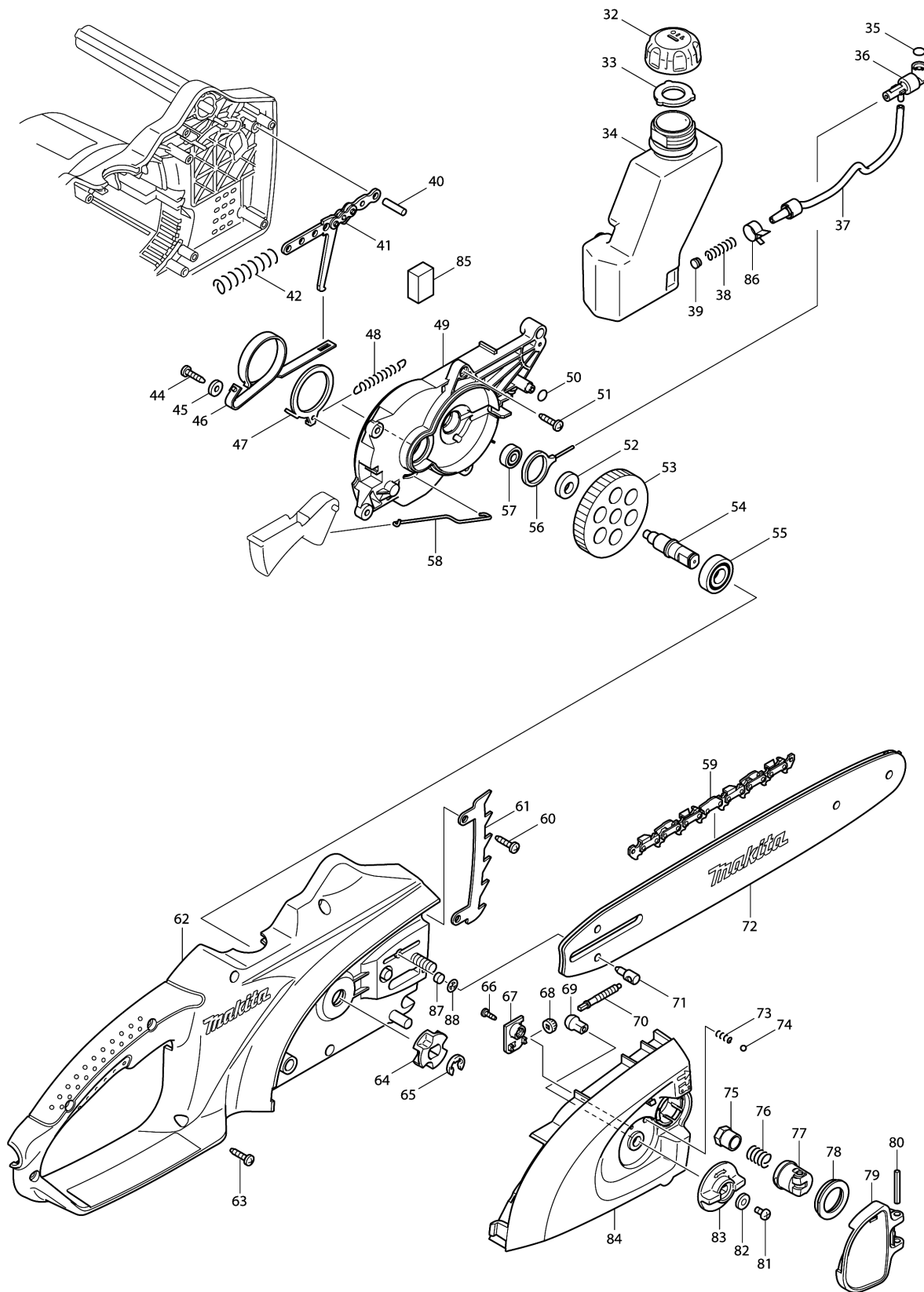

Model No.UC3520A CHAIN SAW 350MM

Item	Parts No.	Description	I/C	Qty	New/Old	Opt. 1	Opt. 2	Note
001	266326-2	TAPPING SCREW 4X18		3				
002	419234-8	REAR COVER		1	*			
002-1	419234-8	REAR COVER	O	1				
003	191972-1	CARBON BRUSH CB-132		1				
004	682211-5	RUBBER SLEEVE		2				
005	861992-6	UC3520A NAME PLATE		1				
006	421938-0	FRONT GRIP		1				
007	266388-0	TAPPING SCREW 5X16		1				
008	267189-9	FLAT WASHER 5		1				
009	419235-6	FRONT HAND GUARD		1				
010	231640-5	TORSION SPRING 20		1				
011	188089-9	HOUSING SET		1				
C10	810866-8	CAUTION LABEL		1				
D10		INC. 62						
012	650577-1	SWITCH SD-006-BB2AA-AA		1				
013	651922-3	SWITCH TG71B		1				
014	233173-6	COMPRESSION SPRING 4		1				
015	416178-3	LOCK-OFF BUTTON		1				
016	416708-0	SWITCH LEVER		1				
017	645200-1	NOISE SUPPRESSOR		1				
018	266326-2	TAPPING SCREW 4X18		2				
019	687052-4	STRAIN RELIEF		1	*			
019-1	687124-5	STRAIN RELIEF	O	1				
020	682540-6	CORD GUARD 9.3-90		1				
021	665876-8	POWER SUPPLY CORD 1.0-2-0.6		1				
022	210029-0	BALL BEARING 608ZZ		1				
023	681644-1	INSULATION WASHER		1				
024	594538-0	FIELD ASS'Y 220-240V		1	*			
C10	654069-2	RECEPTACLE		2	*			
C20	654208-4	RECEPTACLE		1	*			
024-1	593869-4	FIELD ASS'Y 220-240V	O	1				
C10	654069-2	RECEPTACLE		2				
C20	654208-4	RECEPTACLE		1				
025	266389-8	TAPPING SCREW 5X70		2				
026	513643-4	ARMATURE ASS'Y 220-240V		1	*			
D10		INC. 22,23			*			
026-1	513713-9	ARMATURE ASS'Y 220-240V	O	1				
D10		INC. 22,23,29						
028	419238-0	BAFFLE PLATE		1				
029	211061-7	BALL BEARING 6000LLB		1				
030	227153-2	SPUR GEAR 12		1				
031	931403-6	HEX. NUT M8		1				

Please order the parts with part number.

Print Date 4/7/2019

Model No.UC3520A CHAIN SAW 350MM

Item	Parts No.	Description	I/C	Qty	New/Old	Opt. 1	Opt. 2	Note
032	286274-9	CAP		1	*			
032-1	135414-5	CAP ASS'Y	<	1				
D10		INC. 33						
033	421934-8	PACKING		1				
034	419240-3	OIL TANK		1				
035	213039-6	O RING 6		1	*			
035-1	213039-6	O RING 6		1				
036	154762-3	OIL PUMP COMPLETE		1	*			
036-1	158390-6	OIL PUMP COMPLETE	<	1	*			
036-2	158435-0	OIL PUMP COMPLETE	S	1	*			
036-3	158942-3	OIL PUMP COMPLETE	S	1	*			
036-4	142001-3	OIL PUMP COMPLETE	<	1				
037	421935-6	OIL TUBE		1				
038	231975-4	SPRING		1				
039	416274-7	CAP		1				
040	256021-2	PIN 5		1				
041	158047-9	LINK PLATE COMPLETE		1				
042	233175-2	COMPRESSION SPRING 9		1				
044	266326-2	TAPPING SCREW 4X18		1	*			
044-1	265620-9	TAPPING SCREW FLANGE 4X18	S	1				
045	267195-4	FLAT WASHER 4		1	*			
046	168321-7	BRAKE BAND		1				
047	344688-9	BRAKE RING		1				
048	231817-2	TENSION SPRING 5		1				
049	419236-4	BEARING HOLDER		1	*			
049-1	452456-7	BEARING HOLDER	<	1				
050	213039-6	O RING 6		1				
051	266326-2	TAPPING SCREW 4X18		4				
052	417405-1	CAM		1				
053	227154-0	SPUR GEAR 43		1				
054	324619-4	SPINDLE		1				
055	210106-8	BALL BEARING 6001LLB		1				
056	416513-5	CRANK		1	*			
056-1	450230-7	CRANK	S	1				
057	210028-2	BALL BEARING 606ZZ		1				
058	324622-5	ROD		1				
059	528092652	SAW CHAIN 14"		1	*			
059-1	531290052	SAW CHAIN 14"	X	1	*			
059-2	511291752	SAW CHAIN 3/8LP.043" L52 CC D	O	1				
060	266326-2	TAPPING SCREW 4X18		2				
061	345651-5	SPIKE BUMPER		1				

Please order the parts with part number.

Print Date 4/7/2019

Model No.UC3520A CHAIN SAW 350MM

Item	Parts No.	Description	I/C	Qty	New/Old	Opt. 1	Opt. 2	Note
062	188089-9	HOUSING SET		1				
C10	810866-8	CAUTION LABEL		1				
D10		INC. 11						
063	266326-2	TAPPING SCREW 4X18		7				
064	221526-1	SPROCKET		1				
065	259036-8	STOP RING E-8		1				
066	266007-8	TAPPING SCREW BIND PT 3X10		1				
067	419241-1	COVER		1				
068	227496-2	STRAIGHT BEVEL GEAR 14		1				
069	227495-4	STRAIGHT BEVEL GEAR 14		1				
070	324620-9	ADJUST SCREW		1				
071	324621-7	ADJUST PIN		1				
072	165246-6	GUIDE BAR		1	*			
072-1	165246-6	GUIDE BAR	O	1				
073	233033-2	COMPRESSION SPRING 4		1				
074	216008-6	STEEL BALL 4		1				
075	252168-0	HEX. NUT M8-13		1				
076	231025-5	COMPRESSION SPRING 8		1				
077	317977-5	LEVER HOLDER		1				
078	419271-2	CUP WASHER 20		1				
079	154763-1	LEVER COMPLETE		1				
C10	816853-5	INDICATION LABEL		1				
080	951122-8	SPRING PIN 4-28		1				
081	915106-0	BINDING HEAD SCREW M4X8		1				
082	253874-0	FLAT WASHER 4		1				
083	419233-0	DIAL 40		1				
084	154761-5	SPROCKET COVER COMPLETE		1				
085	421960-7	SPONGE		1				
086	324685-1	HOSE CLAMP		1				
087	443125-1	FILTER		1	*			
088	259041-5	PUSH NUT 8		1	*			
089	135249-4	SPROCKET COVER ASS'Y		1				
D10		INC. 66-71,73-84						
A01	158024-1	HOOK COMPLETE		1				
A02	419288-5	CHAIN COVER		1				
A03	803894-0	UC3520A CARTON LABEL		1				

Please order the parts with part number.

Print Date 4/7/2019