

Makita

PARTI DI RICAMBIO

Modello M440 230V~

Cod. 99611B8B

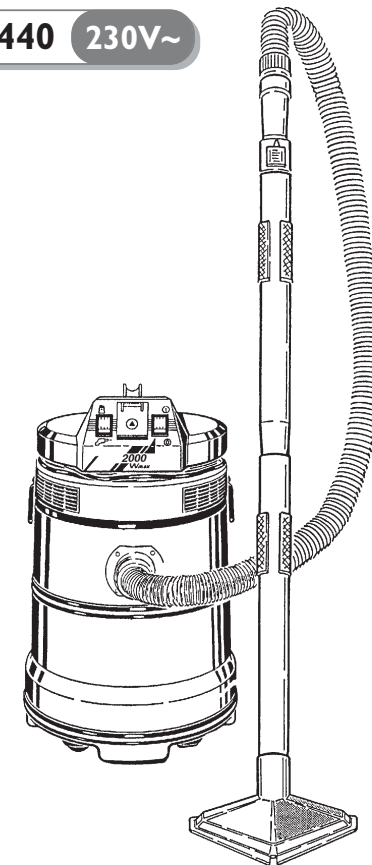

Makita

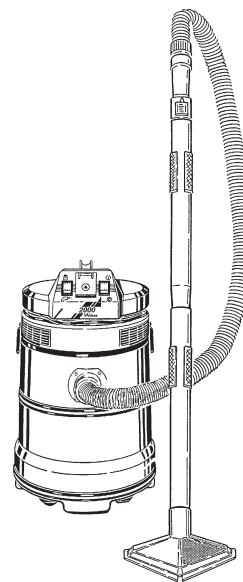
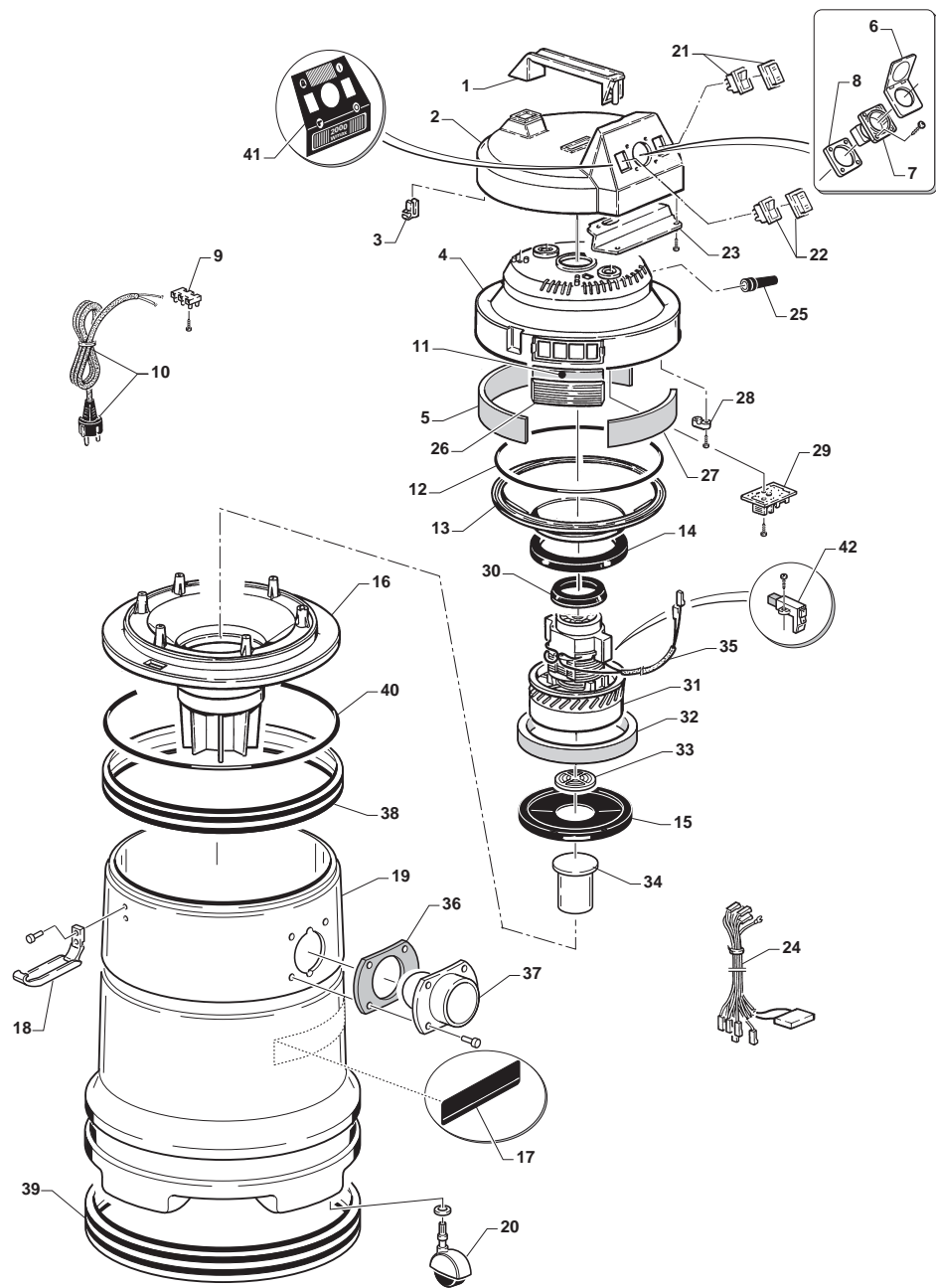

Blank lined area for notes or additional information.

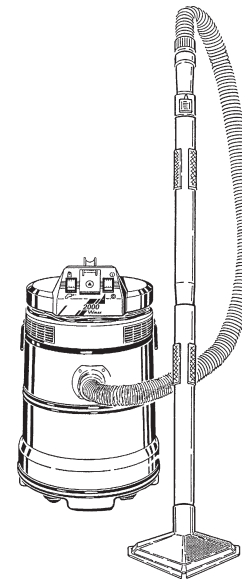
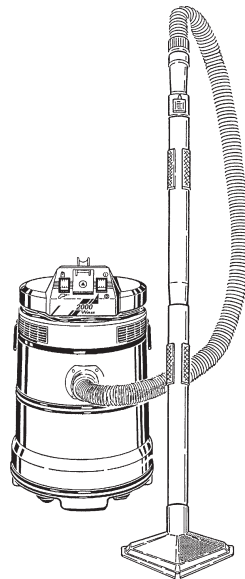

Pos.	Descrizione	Codice	Prezzo € (Cad)
01	Impugnatura	50310B8B
02	Calotta	50305B8B
03	Forcella fermacavo	50335BEN
04	Coprimotore	50181B0A
05	Silenziatore lungo alla calotta	83022B8X
06	Cornice + coperchio	80202B8N
07	Presa Schuko	80200B8N
08	Ghiera per presa	50315BDV
09	Morsetto tripolare	80029B0I
10	Cavo di alimentazione	80017B0N
11	Filtro alla griglia	83021B8X
12	Guarnizione tonda	70016B8N
13	Diaframma	50104B8V
14	Guarnizione tenuta diaframma	70057B0N
15	Guarnizione inferiore tenuta motore	70032B0N
16	Supporto motore	50179B8B
17	Adesivo contenitore	85637B8V
18	Cerniera completa	01015B0A
19	Contenitore	60027BJA
20	Ruota pivotante	30086B0X
21	Interruttore bipolare nero con led rosso	80041BDN
22	Interruttore unipolare	80042BDN
23	Piastra di chiusura	50300BDV
24	Serie cavetti	80101B8V
25	Guidacavo	50338BEN
26	Griglia uscita aria	50170B8A
27	Silenziatore corto alla calotta	83023B8X
28	Fermacavo	50333BEN
29	Scheda elettronica integrata	80209BDX
30	Ammortizzatore superiore motore	70060B8N
31	Motore ED98/1000W/BS/240V~	20052B0X
32	Anello silenziatore	83020B8X
33	Griglia di protezione	50183B0V
34	Galleggiante	50077B0V
35	Tubetto PVC nero mm. 110 - ø 6 mm.	60235BHN
36	Guarnizione in polietilene espanso	70082B5X
37	Raccordo entrata aria	50079B0A
38	Fascia paraurti superiore per contenitore cm. 96	60036BLU
39	Fascia paraurti inferiore per contenitore cm. 112	60037BLU
40	Semitondo gommaspugna	70011B0N
41	Adesivo calotta	85642B8V
42	Inserito porta spazzola	80051B0X

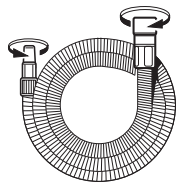

A1

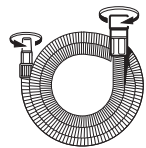

A2

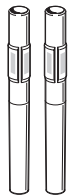

A3



A4

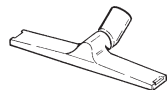

A5

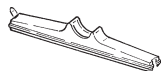

A6

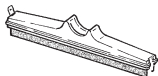

A7



A8



A9



A10



A11

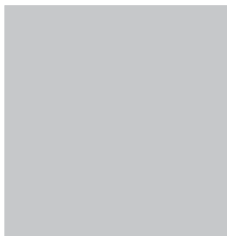

A12



A13



A14



A15

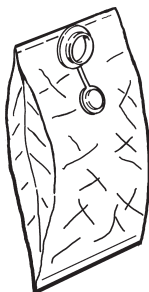

A16

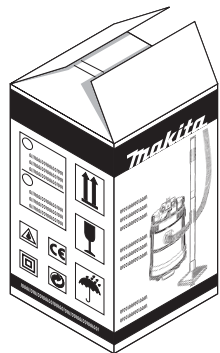

A17

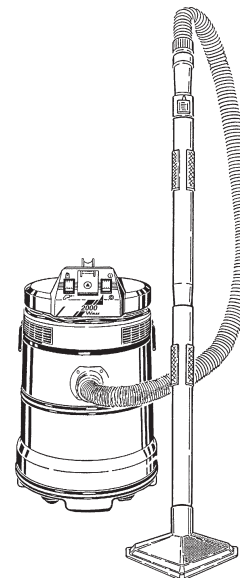

Pos.	Descrizione	Codice	Prezzo € (Cad)
A01	Tubo flessibile ø 45 - L=mt. 2 completo di manicotti.....	01316B0N
A02	Tubo flessibile per elettroutensile ø 25 - L= mt. 3 completo di manicotti.....	01321B0N
A03	Prolunga rigida ø 45	50091B0N
A04	Impugnatura ergonomica ø 45	50093B0N
A05	Spazzola multiuso ø 45	60277B0N
A06	Inserto polvere	60279B0N
A07	Racila per raccogli liquidi	60278B0N
A08	Bocchetta a lancia ø 45	50080B0N
A09	Bocchetta triangolare ø 45	50089B0N
A10	Ghiera blocca cavo per A.S.S.....	50318BHN
A11	Anello sacco raccogli polvere	50707B0N
A12	Sacco filtro P.P.	83100BJA
A13	Filtro-mousse	83035BHB
A14	Elemento filtrante BIA piccolo confezionato	83200BJA
A15	Elemento filtrante BIA piccolo confezionato + disco adattatore	83201BJA
A16	Confezione sacco carta verticale (5 pz.)	83134BOK
A17	Imballo in cartone M440	87327B8I

Schema elettrico

Legenda colore cavi / Cable colour coding

W	Bianco / White
Bk	Nero / Black
R	Rosso / Red
Br	Marrone / Brown
Bl	Blu / Blue
Gr	Verde / Green
Y	Giallo / Yellow

* - con faston - with faston

