

Model No.GA9012C 230MM ANGLE GRINDER

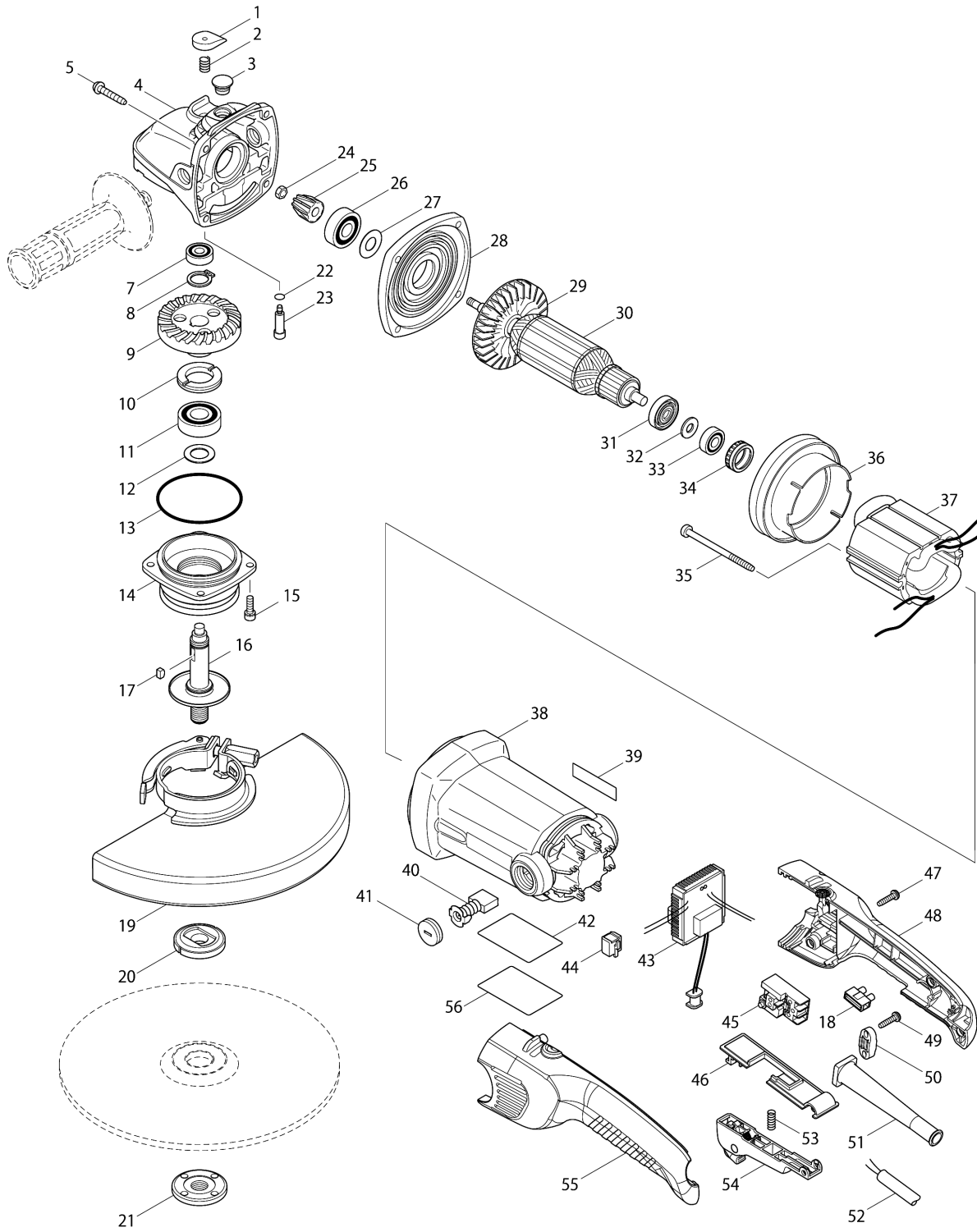

Model No.GA9012C 230MM ANGLE GRINDER

Item	Parts No.	Description	I/C	Qty	New/Old	Opt. 1	Opt. 2	Note
001	418517-3	PIN CAP		1				
002	231037-8	COMPRESSION SPRING 7		1				
003	416972-3	CAP		1				
004	317752-9	GEAR HOUSING		1	*			
004-1	318817-0	GEAR HOUSING	O	1				
005	266553-1	TAPPING SCREW 5X30		4				
007	210043-6	BALL BEARING 608LLB		1				
008	961055-9	RETAINING RING S-15		1				
009	227457-2	SPIRAL BEVEL GEAR 43		1				
010	285809-3	BEARING RETAINER 23-36		1				
011	211228-7	BALL BEARING 6202DDW		1				
012	267215-4	FLAT WASHER 15		1				
013	213720-9	O RING 67		1				
014	318376-4	BEARING BOX		1				
015	922221-3	HEX. SOCKET HEAD BOLT M5X16		4				
016	153785-8	SPINDLE COMPLETE		1				
017	254011-9	WOODRUFF KEY 4		1				
018	654532-5	TERMINAL BLOCK 1P		1				
019	122847-3	TOOLLESS WHEEL COVER 230K		1				
020A	224415-9	INNER FLANGE 42		1	*			
020B	122444-5	INNER FLANGE 47 ASS'Y		1				
020-1A	224490-5	INNER FLANGE 14-45	O	1				
021	224543-0	LOCK NUT 14-45		1				
022	213026-5	O RING 7		1				
023	256483-4	SHOULDER PIN 7		1				
024	931303-0	HEX. NUT M6		1	*			
024-1	252268-6	HEX. NUT M6	O	1				
025	227456-4	SPIRAL BEVEL GEAR 9		1				
026	211106-1	BALL BEARING 6201LLB		1				
027	253759-0	FLAT WASHER 12		1				
028	317753-7	GEAR HOUSING COVER		1				
029	240070-9	FAN 76		1				
030	513568-2	ARMATURE ASS'Y 220-240V		1				
D10		INC. 29,31-33						
031	681660-3	INSULATION WASHER		1				
032	267281-1	FLAT WASHER 8		1				
033	210005-4	BALL BEARING 608DDW		1				
034	421720-7	RUBBER RING 22		1				
035	266386-4	TAPPING SCREW 5X75		2				
036	418516-5	BUFFLE PLATE		1				
037	525824-8	FIELD ASSEMBLY 240V		1	*			

Model No.GA9012C 230MM ANGLE GRINDER

Item	Parts No.	Description	I/C	Qty	New/Old	Opt. 1	Opt. 2	Note
C10	654197-3	RING TERMINAL		2	*			
C20	654502-4	CONNECTOR P-2		2	*			
037-1	625824-9	FIELD 240V	X	1	*			
037-2	625824-9	FIELD 240V	O	1				
038	188846-5	MOTORHOUSING SET		1	*			
C10	643712-8	BRUSH HOLDER		2	*			
D10		INC. 39			*			
038-1	153786-6	MOTOR HOUSING COMPLETE	<	1				
C10	643712-8	BRUSH HOLDER		2				
039	819394-0	MAKITA LOGO LABEL		2	*			
040	191957-7	A.C. CARBON BRUSH CB-204		1				
041	643700-5	BRUSH HOLDER CAP 7-18		2				
042	867636-6	GA9012C NAME PLATE		1				
043	631950-4	CONTROLLER		1				
044	418518-1	SLEEVE		1				
045	651922-3	SWITCH TG71B		1	*			
045-1	650677-7	SWITCH C3PA-1112	<	1	*			
045-2	651922-3	SWITCH TG71B	<	1				
046	451637-0	SWITCH BASE		1				
047	265995-6	TAPPING SCREW 4X18		4				
048	188826-1	HANDLE SET		1				
C10	450184-8	LENS		1				
D10		INC. 55						
049	265995-6	TAPPING SCREW 4X18		2				
050	687124-5	STRAIN RELIEF		1				
051	682573-1	CORD GUARD 10		1				
052	665865-3	POWER SUPPLY CORD 1.0-2-2.5		1				
053	233117-6	COMPRESSION SPRING 6		1				
054	140358-6	SWITCH LEVER COMPLETE		1				
055	188826-1	HANDLE SET		1				
C10	450184-8	LENS		1				
D10		INC. 48						
056	819395-8	CLEAR LABEL		1	*			
056-1	892810-7	CLEAR LABEL		1				
A01	152539-0	GRIP 36 COMPLETE		1				
A02	782407-9	LOCK NUT WRENCH 35		1	*			
A02-1	782034-2	LOCK NUT WRENCH 35	O	1				

Please order the parts with part number.

Print Date 8/9/2020