

Model No.DMR050 FLASHLIGHT RADIO

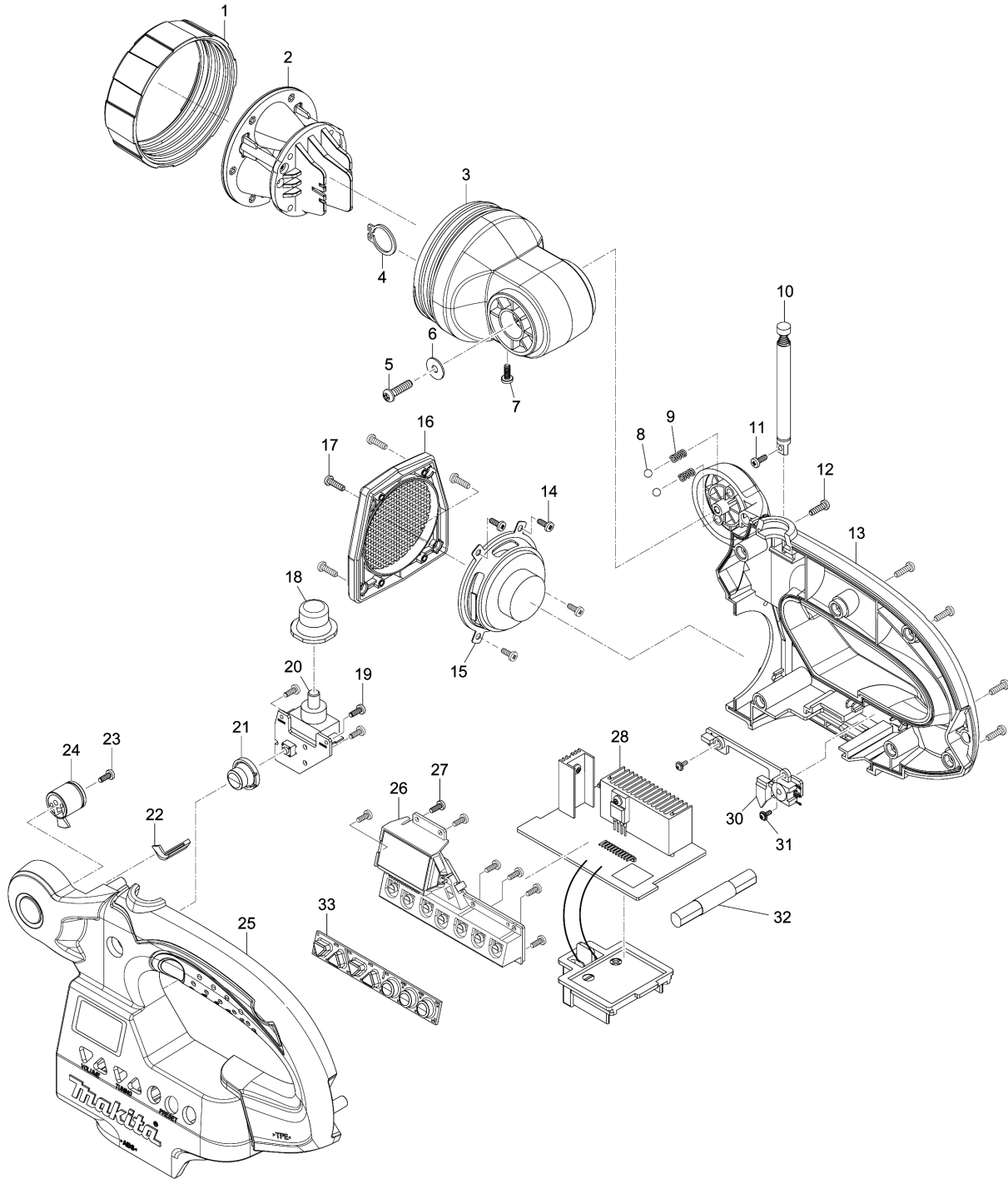

Model No.DMR050 FLASHLIGHT RADIO

Item	Parts No.	Description	I/C	Qty	New/Old	Opt. 1	Opt. 2	Note
001	SE00000108	LIGHT COVER		1				
002	SE00000109	LED MOUDLE		1				
C10	SE00000110	REFLECTOR		1				
003	SE00000111	LIGHT REAR COVER		1				
004	SE00000112	C RING		1				
005	SE00000113	SCREW M4X15		1				
006	SE00000114	WASHER 4		1				
007	SE00000115	SCREW M3X8		1				
008	SE00000116	STEEL BALL 4		2				
009	SE00000117	CLICK SPRING		2				
010	SE00000118	ROD ANT		1				
011	SE00000119	SCREW M2.6X7		1				
012	SE00000120	SCREW M3X10		5				
013	SE00000121	REAR CABINET		1				
014	SE00000119	SCREW M2.6X7		4				
015	SE00000122	SPEAKER KIT		1				
016	SE00000123	SPEAKER GRILL		1				
017	SE00000120	SCREW M3X10		4				
018	SE00000124	PUSH KNOB		1				
019	SE00000119	SCREW M2.6X7		3				
020	SE00000125	LIGHT KNOB ASSY		1				
021	SE00000126	PUSH KNOB		1				
022	SE00000127	WIRE COVER		1				
023	SE00000119	SCREW M2.6X7		1				
024	SE00000128	LIGHT SHAFT		1				
025	SE00000129	FRONT CABINET		1				
026	SE00000130	CIRCUIT BOARD C ASSY		1				
027	SE00000119	SCREW M2.6X7		7				
028	SE00000133	CIRCUIT BOARD A ASSY		1				
030	SE00000134	SENSOR TERMINAL ASSY		1				
031	SE00000135	SCREW M2X5		2				
032	SE00000136	BAR ANT ASSY		1				
033	SE00000137	PUSH KNOB FUNCTION		1				
A01	SE00000138	STRAP		1				

Please order the parts with part number.

Print Date 8/9/2020