

Model No.DML185 RECHARGEABLE FLASHLIGHT

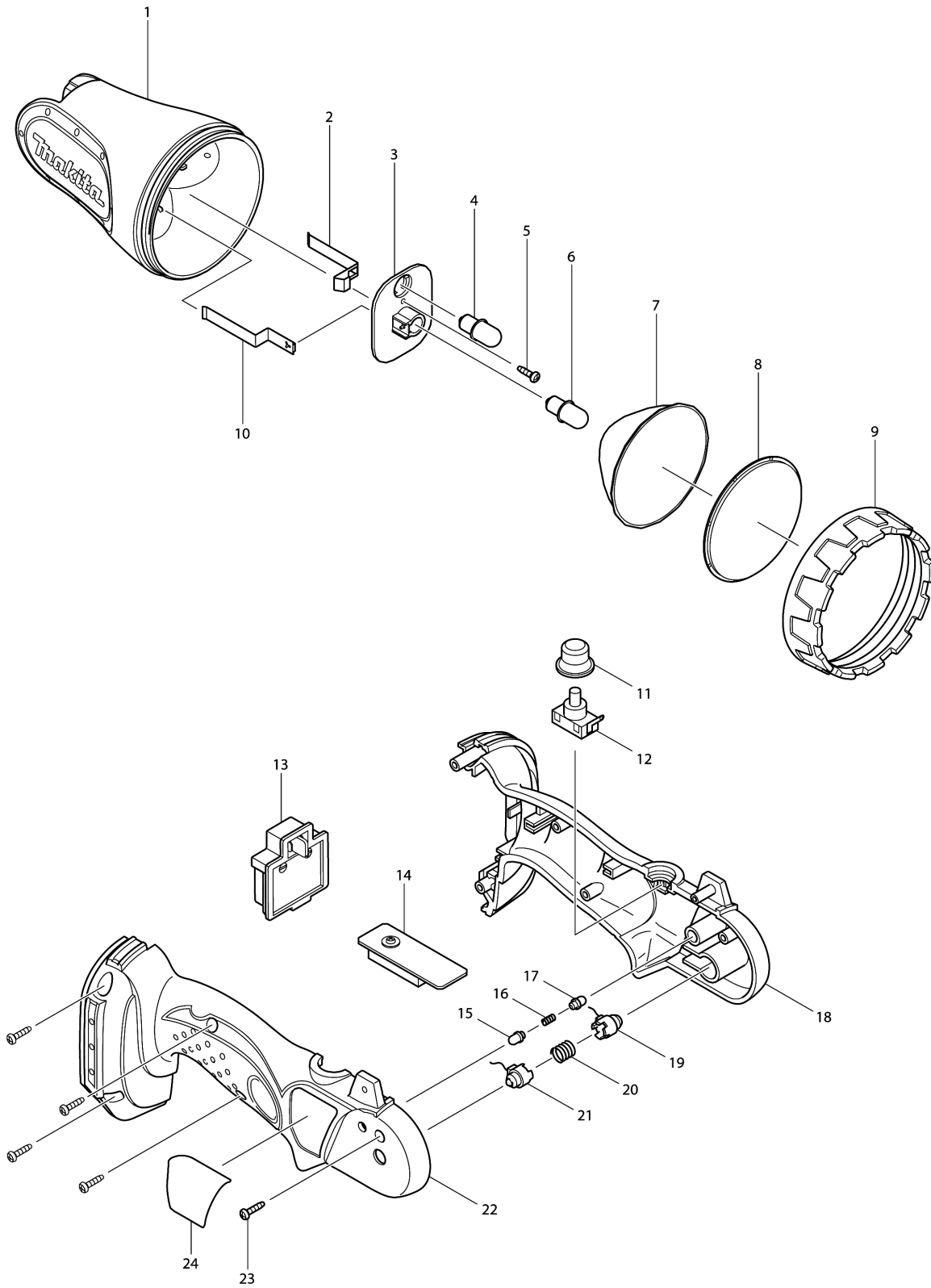

Model No.DML185 RECHARGEABLE FLASHLIGHT

Item	Parts No.	Description	I/C	Qty	New/Old	Opt. 1	Opt. 2	Note
001	GM00001003	CASE HEAD 30105185104		1				
002	GM00001010	BULB CONTACT PLATE- 21201185002		1				
003	GM00001002	PROTECTOR(CONTACT)32009120012		1				
004	A-90261	BULB SET		1	*			
004-1	A-30542	BULB SET	<	1				
005	GM00001012	SCREW 3X12 PB BLACK ZN		1				
006	A-90261	BULB SET		1	*			
006-1	A-30542	BULB SET	<	1				
007	GM00000130	REFLECTOR		1				
008	GM00000070	LENS		1				
009	GM00001001	REFLECTOR RETAINER 30110185003		1				
010	GM00001009	BULB CONTACT PLATE (+)		1				
011	GM00001006	RUBBER COVER 39010185004		1				
012	GM00000200	SWITCH		1				
013	GM00001055	BATTERY HOLDER (C2010185006)		1	*			
013-1	GM00001116	BATTERY HOLDER (C2004185006)	O	1				
014	GM00001011	CIRCUIT BOARD G0314500101		1	*			
014-1	GM00001029	CIRCUIT BOARD G0318500100	<	1				
015	GM00001005	KNOCK SHAFT 31011120009		1				
016	GM00000090	COMPRESSION SPRING 4		1				
017	GM00001005	KNOCK SHAFT 31011120009		1				
018	GM00001000	HOUSING SET		1				
D10		INC. 22						
019	632524-4	PIVOT TERMINAL UNIT R		1	*			
019-1	GM00001004	LEFT CASE SHAFT 3101012003	X	1				
020	233144-3	COMPRESSION SPRING 7		1				
021	GM00001004	LEFT CASE SHAFT 3101012003		1	*			
021-1	632524-4	PIVOT TERMINAL UNIT R	X	1				
022	GM00001000	HOUSING SET		1				
D10		INC. 18						
023	GM00001013	SCREW 3X14 PB BLACK ZN		5				
024	GM00001008	NAME PLATE		1	*			
024-1	GM00001453	NAME PLATE D0111850100	X	1				
025	812V28-6	CAUTION LABEL		1				

Please order the parts with part number.

Print Date 8/9/2020