

INSTRUCTION MANUAL

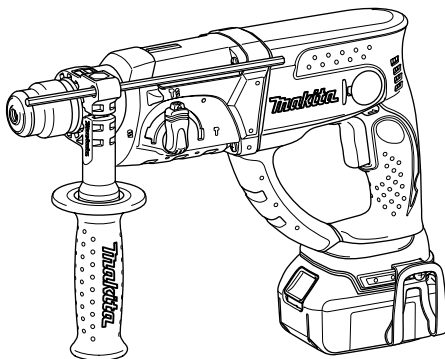

Cordless Combination Hammer

DHR202



008828

IMPORTANT: Read Before Using.

ENGLISH (Original instructions)

SPECIFICATIONS

Model		DHR202
Capacities	Concrete	20 mm
	Steel	13 mm
	Wood	26 mm
No load speed (min ⁻¹)		0 - 1,200
Blows per minute		0 - 4,000
Overall length		358 mm
Net weight		3.5 kg
Rated voltage		D.C. 18 V

- Due to our continuing program of research and development, the specifications herein are subject to change without notice.
- Specifications and battery cartridge may differ from country to country.
- Weight, with battery cartridge, according to EPTA-Procedure 01/2003

END004-4

ENG900-1

Symbols

The following show the symbols used for the equipment. Be sure that you understand their meaning before use.



- Read instruction manual.



- Only for EU countries

Do not dispose of electric equipment or battery pack together with household waste material!

In observance of European Directive 2002/96/EC on waste electric and electronic equipment, 2006/66/EC on batteries and accumulators and waste batteries and accumulators and their implementation in accordance with national laws, electric equipment and battery pack that have reached the end of their life must be collected separately and returned to an environmentally compatible recycling facility.

ENE043-1

Intended use

The tool is intended for hammer drilling and drilling in brick, concrete and stone as well as for chiselling work. It is also suitable for drilling without impact in wood, metal, ceramic and plastic.

ENG905-1

Noise

The typical A-weighted noise level determined according to EN60745:

Sound pressure level (L_{pA}) : 87 dB (A)

Sound power level (L_{WA}) : 98 dB (A)

Uncertainty (K) : 3 dB (A)

Wear ear protection

Vibration

The vibration total value (tri-axial vector sum) determined according to EN60745:

Work mode : hammer drilling into concrete

Vibration emission ($a_{h,HD}$) : 14.5 m/s²

Uncertainty (K) : 1.5 m/s²

Work mode : chiselling

Vibration emission ($a_{h,CHeg}$) : 11.0 m/s²

Uncertainty (K) : 1.5 m/s²

Work mode: drilling into metal

Vibration emission ($a_{h,D}$) : 3.0 m/s²

Uncertainty (K) : 1.5 m/s²

ENG901-1

- The declared vibration emission value has been measured in accordance with the standard test method and may be used for comparing one tool with another.
- The declared vibration emission value may also be used in a preliminary assessment of exposure.

⚠WARNING:

- The vibration emission during actual use of the power tool can differ from the declared emission value depending on the ways in which the tool is used.
- Be sure to identify safety measures to protect the operator that are based on an estimation of exposure in the actual conditions of use (taking account of all parts of the operating cycle such as the times when the tool is switched off and when it is running idle in addition to the trigger time).

For European countries only**EC Declaration of Conformity**

Makita declares that the following Machine(s):

Designation of Machine:

Cordless Combination Hammer

Model No./ Type: DHR202

Conforms to the following European Directives:

2006/42/EC

They are manufactured in accordance with the following Standard or standardized documents:

EN60745

The Technical file in accordance with 2006/42/EC is available from:

Makita, Jan-Baptist Vinkstraat 2, 3070, Belgium

31.12.2013



000331

Yasushi Fukaya

Director

Makita, Jan-Baptist Vinkstraat 2, 3070, Belgium

GEA006-2

General Power Tool Safety**Warnings**

⚠ WARNING Read all safety warnings and all instructions. Failure to follow the warnings and instructions may result in electric shock, fire and/or serious injury.

Save all warnings and instructions for future reference.

The term "power tool" in the warnings refers to your mains-operated (corded) power tool or battery-operated (cordless) power tool.

Work area safety

1. **Keep work area clean and well lit.** Cluttered or dark areas invite accidents.
2. **Do not operate power tools in explosive atmospheres, such as in the presence of flammable liquids, gases or dust.** Power tools create sparks which may ignite the dust or fumes.
3. **Keep children and bystanders away while operating a power tool.** Distractions can cause you to lose control.

Electrical safety

4. **Power tool plugs must match the outlet. Never modify the plug in any way. Do not use any adapter plugs with earthed (grounded) power tools.** Unmodified plugs and matching outlets will reduce risk of electric shock.

5. **Avoid body contact with earthed or grounded surfaces such as pipes, radiators, ranges and refrigerators.** There is an increased risk of electric shock if your body is earthed or grounded.
6. **Do not expose power tools to rain or wet conditions.** Water entering a power tool will increase the risk of electric shock.
7. **Do not abuse the cord. Never use the cord for carrying, pulling or unplugging the power tool. Keep cord away from heat, oil, sharp edges or moving parts.** Damaged or entangled cords increase the risk of electric shock.
8. **When operating a power tool outdoors, use an extension cord suitable for outdoor use.** Use of a cord suitable for outdoor use reduces the risk of electric shock.
9. **If operating a power tool in a damp location is unavoidable, use a ground fault circuit interrupter (GFCI) protected supply.** Use of an GFCI reduces the risk of electric shock.

Personal safety

10. **Stay alert, watch what you are doing and use common sense when operating a power tool. Do not use a power tool while you are tired or under the influence of drugs, alcohol or medication.** A moment of inattention while operating power tools may result in serious personal injury.
11. **Use personal protective equipment. Always wear eye protection.** Protective equipment such as dust mask, non-skid safety shoes, hard hat, or hearing protection used for appropriate conditions will reduce personal injuries.
12. **Prevent unintentional starting. Ensure the switch is in the off-position before connecting to power source and/or battery pack, picking up or carrying the tool.** Carrying power tools with your finger on the switch or energising power tools that have the switch on invites accidents.
13. **Remove any adjusting key or wrench before turning the power tool on.** A wrench or a key left attached to a rotating part of the power tool may result in personal injury.
14. **Do not overreach. Keep proper footing and balance at all times.** This enables better control of the power tool in unexpected situations.
15. **Dress properly. Do not wear loose clothing or jewellery. Keep your hair, clothing, and gloves away from moving parts.** Loose clothes, jewellery or long hair can be caught in moving parts.
16. **If devices are provided for the connection of dust extraction and collection facilities, ensure these are connected and properly used.** Use of dust collection can reduce dust-related hazards.

Power tool use and care

17. **Do not force the power tool. Use the correct power tool for your application.** The correct power tool will do the job better and safer at the rate for which it was designed.
18. **Do not use the power tool if the switch does not turn it on and off.** Any power tool that cannot be controlled with the switch is dangerous and must be repaired.
19. **Disconnect the plug from the power source and/or the battery pack from the power tool before making any adjustments, changing accessories, or storing power tools.** Such preventive safety measures reduce the risk of starting the power tool accidentally.
20. **Store idle power tools out of the reach of children and do not allow persons unfamiliar with the power tool or these instructions to operate the power tool.** Power tools are dangerous in the hands of untrained users.
21. **Maintain power tools. Check for misalignment or binding of moving parts, breakage of parts and any other condition that may affect the power tool's operation. If damaged, have the power tool repaired before use.** Many accidents are caused by poorly maintained power tools.
22. **Keep cutting tools sharp and clean.** Properly maintained cutting tools with sharp cutting edges are less likely to bind and are easier to control.
23. **Use the power tool, accessories and tool bits etc. in accordance with these instructions, taking into account the working conditions and the work to be performed.** Use of the power tool for operations different from those intended could result in a hazardous situation.

Battery tool use and care

24. **Recharge only with the charger specified by the manufacturer.** A charger that is suitable for one type of battery pack may create a risk of fire when used with another battery pack.
25. **Use power tools only with specifically designated battery packs.** Use of any other battery packs may create a risk of injury and fire.
26. **When battery pack is not in use, keep it away from other metal objects, like paper clips, coins, keys, nails, screws or other small metal objects, that can make a connection from one terminal to another.** Shorting the battery terminals together may cause burns or a fire.
27. **Under abusive conditions, liquid may be ejected from the battery; avoid contact. If contact accidentally occurs, flush with water. If liquid contacts eyes, additionally seek medical help.** Liquid ejected from the battery may cause irritation or burns.

Service

28. **Have your power tool serviced by a qualified repair person using only identical replacement parts.** This will ensure that the safety of the power tool is maintained.
29. **Follow instruction for lubricating and changing accessories.**
30. **Keep handles dry, clean and free from oil and grease.**

GEB046-2

CORDLESS ROTARY HAMMER SAFETY WARNINGS

1. **Wear ear protectors.** Exposure to noise can cause hearing loss.
2. **Use auxiliary handle(s), if supplied with the tool.** Loss of control can cause personal injury.
3. **Hold power tool by insulated gripping surfaces, when performing an operation where the cutting accessory may contact hidden wiring.** Cutting accessory contacting a "live" wire may make exposed metal parts of the power tool "live" and could give the operator an electric shock.
4. **Wear a hard hat (safety helmet), safety glasses and/or face shield. Ordinary eye or sun glasses are NOT safety glasses. It is also highly recommended that you wear a dust mask and thickly padded gloves.**
5. **Be sure the bit is secured in place before operation.**
6. **Under normal operation, the tool is designed to produce vibration. The screws can come loose easily, causing a breakdown or accident. Check tightness of screws carefully before operation.**
7. **In cold weather or when the tool has not been used for a long time, let the tool warm up for a while by operating it under no load. This will loosen up the lubrication. Without proper warm-up, hammering operation is difficult.**
8. **Always be sure you have a firm footing. Be sure no one is below when using the tool in high locations.**
9. **Hold the tool firmly with both hands.**
10. **Keep hands away from moving parts.**
11. **Do not leave the tool running. Operate the tool only when hand-held.**
12. **Do not point the tool at any one in the area when operating. The bit could fly out and injure someone seriously.**
13. **Do not touch the bit or parts close to the bit immediately after operation; they may be extremely hot and could burn your skin.**

-
14. Some material contains chemicals which may be toxic. Take caution to prevent dust inhalation and skin contact. Follow material supplier safety data.

SAVE THESE INSTRUCTIONS.

⚠WARNING:

DO NOT let comfort or familiarity with product (gained from repeated use) replace strict adherence to safety rules for the subject product. MISUSE or failure to follow the safety rules stated in this instruction manual may cause serious personal injury.

ENC007-7

IMPORTANT SAFETY INSTRUCTIONS

FOR BATTERY CARTRIDGE

1. Before using battery cartridge, read all instructions and cautionary markings on (1) battery charger, (2) battery, and (3) product using battery.
2. Do not disassemble battery cartridge.
3. If operating time has become excessively shorter, stop operating immediately. It may result in a risk of overheating, possible burns and even an explosion.
4. If electrolyte gets into your eyes, rinse them out with clear water and seek medical attention right away. It may result in loss of your eyesight.
5. Do not short the battery cartridge:
 - (1) Do not touch the terminals with any conductive material.
 - (2) Avoid storing battery cartridge in a container with other metal objects such as nails, coins, etc.
 - (3) Do not expose battery cartridge to water or rain.

A battery short can cause a large current flow, overheating, possible burns and even a breakdown.
6. Do not store the tool and battery cartridge in locations where the temperature may reach or exceed 50 ° C (122 ° F).
7. Do not incinerate the battery cartridge even if it is severely damaged or is completely worn out. The battery cartridge can explode in a fire.
8. Be careful not to drop or strike battery.
9. Do not use a damaged battery.

SAVE THESE INSTRUCTIONS.

Tips for maintaining maximum battery life

1. Charge the battery cartridge before completely discharged. Always stop tool operation and charge the battery cartridge when you notice less tool power.
2. Never recharge a fully charged battery cartridge. Overcharging shortens the battery service life.
3. Charge the battery cartridge with room temperature at 10 ° C - 40 ° C (50 ° F - 104 ° F). Let a hot battery cartridge cool down before charging it.
4. Charge the battery cartridge once in every six months if you do not use it for a long period of time.

FUNCTIONAL DESCRIPTION

⚠CAUTION:

- Always be sure that the tool is switched off and the battery cartridge is removed before adjusting or checking function on the tool.

Installing or removing battery cartridge

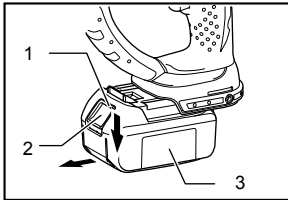

1. Red indicator
2. Button
3. Battery cartridge

012133

- Always switch off the tool before installing or removing of the battery cartridge.
- To remove the battery cartridge, slide it from the tool while sliding the button on the front of the cartridge.
- To install the battery cartridge, align the tongue on the battery cartridge with the groove in the housing and slip it into place. Always insert it all the way until it locks in place with a little click. If you can see the red indicator on the upper side of the button, it is not locked completely. Install it fully until the red indicator cannot be seen. If not, it may accidentally fall out of the tool, causing injury to you or someone around you.
- Do not use force when installing the battery cartridge. If the cartridge does not slide in easily, it is not being inserted correctly.

Battery protection system (Lithium-ion battery with star marking)

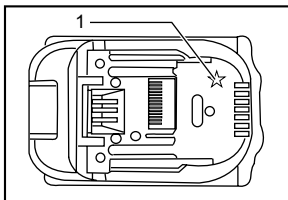

1. Star marking

012128

Lithium-ion batteries with a star marking are equipped with a protection system. This system automatically cuts off power to the tool to extend battery life.

The tool will automatically stop during operation if the tool and/or battery are placed under one of the following conditions:

- **Overloaded:**
The tool is operated in a manner that causes it to draw an abnormally high current. In this situation, release the trigger switch on the tool and stop the application that caused the tool to become overloaded. Then pull the trigger switch again to restart. If the tool does not start, the battery is overheated. In this situation, let the battery cool before pulling the trigger switch again.
- **Low battery voltage:**
The remaining battery capacity is too low and the tool will not operate. In this situation, remove and recharge the battery.

Switch action

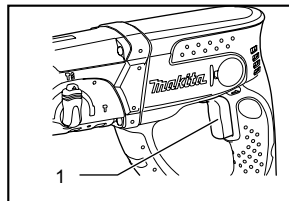

1. Switch trigger

008831

⚠CAUTION:

- Before inserting the battery cartridge into the tool, always check to see that the switch trigger actuates properly and returns to the "OFF" position when released.

To start the tool, simply pull the switch trigger. Tool speed is increased by increasing pressure on the switch trigger. Release the switch trigger to stop.

Lighting up the lamp

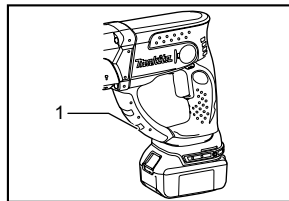

1. Lamp

008836

⚠CAUTION:

- Do not look in the light or see the source of light directly.

Pull the switch trigger to light up the lamp. The lamp keeps on lighting while the switch trigger is being pulled. The light automatically goes out 10 - 15 seconds after the switch trigger is released.

NOTE:

- Use a dry cloth to wipe the dirt off the lens of lamp. Be careful not to scratch the lens of lamp, or it may lower the illumination.
- Do not use thinner or gasoline to clean the lamp. Such solvents may damage it.

Reversing switch action

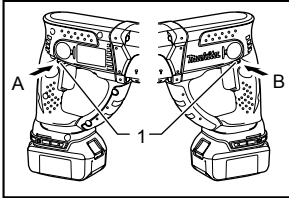

008832

This tool has a reversing switch to change the direction of rotation. Depress the reversing switch lever from the A side for clockwise rotation or from the B side for counterclockwise rotation.

When the reversing switch lever is in the neutral position, the switch trigger cannot be pulled.

⚠CAUTION:

- Always check the direction of rotation before operation.
- Use the reversing switch only after the tool comes to a complete stop. Changing the direction of rotation before the tool stops may damage the tool.
- When not operating the tool, always set the reversing switch lever to the neutral position.

Selecting the action mode

Rotation with hammering

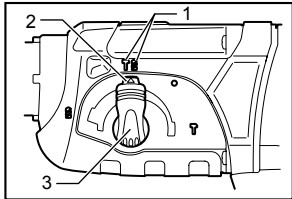

007575

For drilling in concrete, masonry, etc., depress the lock button and rotate the action mode changing knob to the symbol. Use a tungsten-carbide tipped bit.

Rotation only

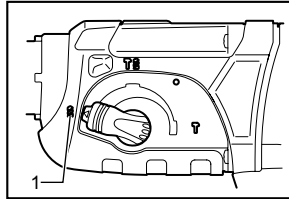

007576

For drilling in wood, metal or plastic materials, depress the lock button and rotate the action mode changing knob to the symbol. Use a twist drill bit or wood bit.

Hammering only

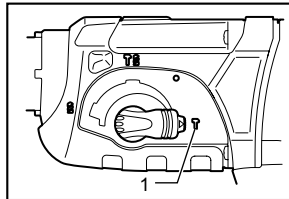

007577

For chipping, scaling or demolition operations, depress the lock button and rotate the action mode changing knob to the symbol. Use a bull point, cold chisel, scaling chisel, etc.

⚠CAUTION:

- Do not rotate the action mode changing knob when the tool is running. The tool will be damaged.
- To avoid rapid wear on the mode change mechanism, be sure that the action mode changing knob is always positively located in one of the three action mode positions.

Torque limiter

The torque limiter will actuate when a certain torque level is reached. The motor will disengage from the output shaft. When this happens, the bit will stop turning.

⚠CAUTION:

- As soon as the torque limiter actuates, switch off the tool immediately. This will help prevent premature wear of the tool.
- Hole saws cannot be used with this tool. They tend to pinch or catch easily in the hole. This will cause the torque limiter to actuate too frequently.

ASSEMBLY

⚠ CAUTION:

- Always be sure that the tool is switched off and the battery cartridge is removed before carrying out any work on the tool.

Side grip (auxiliary handle)

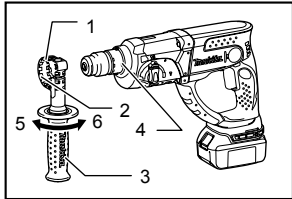

008830

- Grip base
- Teeth
- Side grip
- Protrusion
- Loosen
- Tighten

⚠ CAUTION:

- Always use the side grip to ensure operating safety. Install the side grip so that the teeth on the grip fit in between the protrusions on the tool barrel. Then tighten the grip by turning clockwise at the desired position. It may be swung 360° so as to be secured at any position.

Bit grease

Coat the bit shank beforehand with a small amount of bit grease (about 0.5 - 1 g). This chuck lubrication assures smooth action and longer service life.

Installing or removing the bit

Clean the bit shank and apply bit grease before installing the bit.

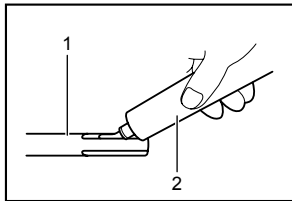

001296

Insert the bit into the tool. Turn the bit and push it in until it engages.

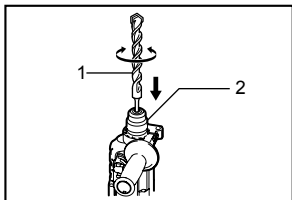

007342

- Bit
- Chuck cover

If the bit cannot be pushed in, remove the bit. Pull the chuck cover down a couple of times. Then insert the bit again. Turn the bit and push it in until it engages.

After installing, always make sure that the bit is securely held in place by trying to pull it out.

To remove the bit, pull the chuck cover down all the way and pull the bit out.

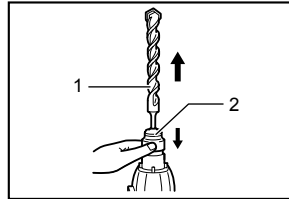

001298

- Bit
- Chuck cover

Bit angle (when chipping, scaling or demolishing)

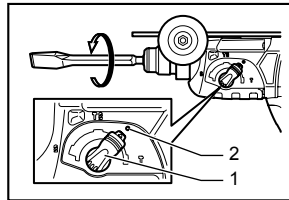

007576

- Action mode changing knob
- O symbol

The bit can be secured at the desired angle. To change the bit angle, depress the lock button and rotate the action mode changing knob to the O symbol. Turn the bit to the desired angle.

Depress the lock button and rotate the action mode changing knob to the T symbol. Then make sure that the bit is securely held in place by turning it slightly.

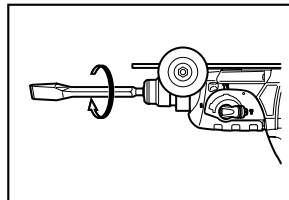

007579

Depth gauge

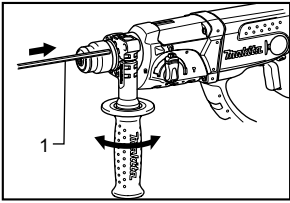

1. Depth gauge

008838

The depth gauge is convenient for drilling holes of uniform depth. Loosen the side grip and insert the depth gauge into the hole in the side grip. Adjust the depth gauge to the desired depth and tighten the side grip.

NOTE:

- The depth gauge cannot be used at the position where the depth gauge strikes against the gear housing.

Dust cup

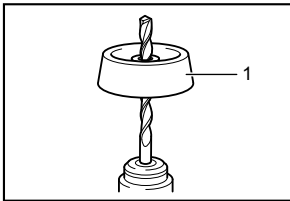

1. Dust cup

001300

Use the dust cup to prevent dust from falling over the tool and on yourself when performing overhead drilling operations. Attach the dust cup to the bit as shown in the figure. The size of bits which the dust cup can be attached to is as follows.

	Bit diameter
Dust cup 5	6 mm - 14.5 mm
Dust cup 9	12 mm - 16 mm

006382

OPERATION

Hammer drilling operation

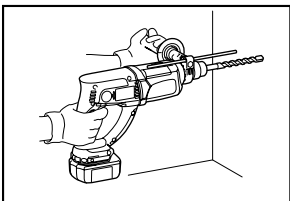

008833

Set the action mode changing knob to the  symbol. Position the bit at the desired location for the hole, then pull the switch trigger.

Do not force the tool. Light pressure gives best results. Keep the tool in position and prevent it from slipping away from the hole.

Do not apply more pressure when the hole becomes clogged with chips or particles. Instead, run the tool at an idle, then remove the bit partially from the hole. By repeating this several times, the hole will be cleaned out and normal drilling may be resumed.

⚠CAUTION:

- There is a tremendous and sudden twisting force exerted on the tool/bit at the time of hole break-through, when the hole becomes clogged with chips and particles, or when striking reinforcing rods embedded in the concrete. Always use the side grip (auxiliary handle) and firmly hold the tool by both side grip and switch handle during operations. Failure to do so may result in the loss of control of the tool and potentially severe injury.

NOTE:

Eccentricity in the bit rotation may occur while operating the tool with no load. The tool automatically centers itself during operation. This does not affect the drilling precision.

Blow-out bulb (optional accessory)

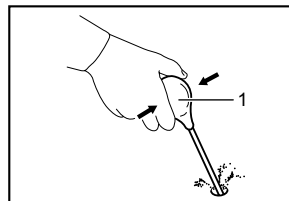

1. Blow-out bulb

002449

After drilling the hole, use the blow-out bulb to clean the dust out of the hole.

Chipping/Scaling/Demolition

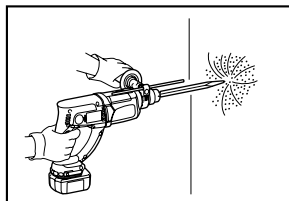

008837

Set the action mode changing knob to the  symbol. Hold the tool firmly with both hands. Turn the tool on and apply slight pressure on the tool so that the tool will not bounce around, uncontrolled. Pressing very hard on the tool will not increase the efficiency.

Drilling in wood or metal

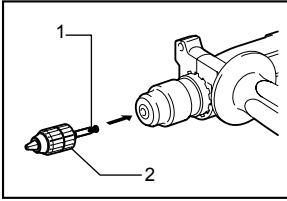

004223

1. Chuck adapter
2. Keyless drill chuck

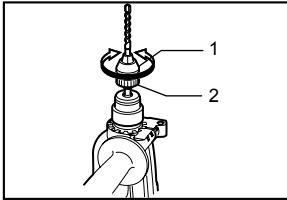

007048

1. Sleeve
2. Ring

Use the optional drill chuck assembly. When installing it, refer to "Installing or removing the bit" described on the previous page.

Set the action mode changing knob so that the pointer points to the  symbol.

⚠ CAUTION:

- Never use "rotation with hammering" when the drill chuck assembly is installed on the tool. The drill chuck assembly may be damaged. Also, the drill chuck will come off when reversing the tool.
- Pressing excessively on the tool will not speed up the drilling. In fact, this excessive pressure will only serve to damage the tip of your bit, decrease the tool performance and shorten the service life of the tool.
- There is a tremendous twisting force exerted on the tool/bit at the time of hole breakthrough. Hold the tool firmly and exert care when the bit begins to break through the workpiece.
- A stuck bit can be removed simply by setting the reversing switch to reverse rotation in order to back out. However, the tool may back out abruptly if you do not hold it firmly.
- Always secure small workpieces in a vise or similar hold-down device.

MAINTENANCE

⚠ CAUTION:

- Always be sure that the tool is switched off and the battery cartridge is removed before attempting to perform inspection or maintenance.
- Never use gasoline, benzene, thinner, alcohol or the like. Discoloration, deformation or cracks may result.

Replacing carbon brushes

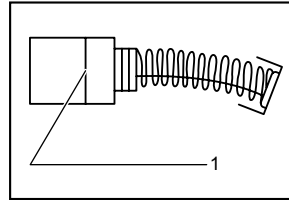

001145

1. Limit mark

Remove and check the carbon brushes regularly. Replace when they wear down to the limit mark. Keep the carbon brushes clean and free to slip in the holders. Both carbon brushes should be replaced at the same time. Use only identical carbon brushes.

Remove holder cap covers by inserting the slotted bit screwdriver into the recessed part in the tool and lifting it up.

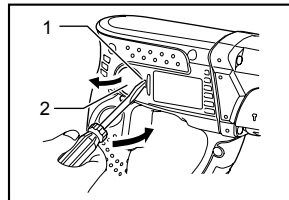

008834

1. Recessed part
2. Holder cap cover

Use a screwdriver to remove the brush holder caps. Take out the worn carbon brushes, insert the new ones and secure the brush holder caps.

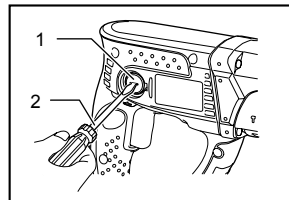

008835

1. Brush holder cap
2. Screwdriver

Remount the holder cap covers on the tool.

To maintain product SAFETY and RELIABILITY, repairs, any other maintenance or adjustment should be performed by Makita Authorized Service Centers, always using Makita replacement parts.

OPTIONAL ACCESSORIES

CAUTION:

- These accessories or attachments are recommended for use with your Makita tool specified in this manual. The use of any other accessories or attachments might present a risk of injury to persons. Only use accessory or attachment for its stated purpose.

If you need any assistance for more details regarding these accessories, ask your local Makita Service Center.

- SDS-Plus Carbide-tipped bits
- Bull point
- Cold chisel
- Scaling chisel
- Grooving chisel
- Drill chuck assembly
- Drill chuck S13
- Chuck adapter
- Chuck key S13
- Bit grease
- Side grip
- Depth gauge
- Blow-out bulb
- Dust cup
- Dust extractor attachment
- Safety goggles
- Plastic carrying case
- Keyless drill chuck
- Various type of Makita genuine batteries and chargers

NOTE:

- Some items in the list may be included in the tool package as standard accessories. They may differ from country to country.

Makita Jan-Baptist Vinkstraat 2, 3070, Belgium
Makita Corporation Anjo, Aichi, Japan