

Model No.ADP10 INTERCHANGEABLE ADAPTER

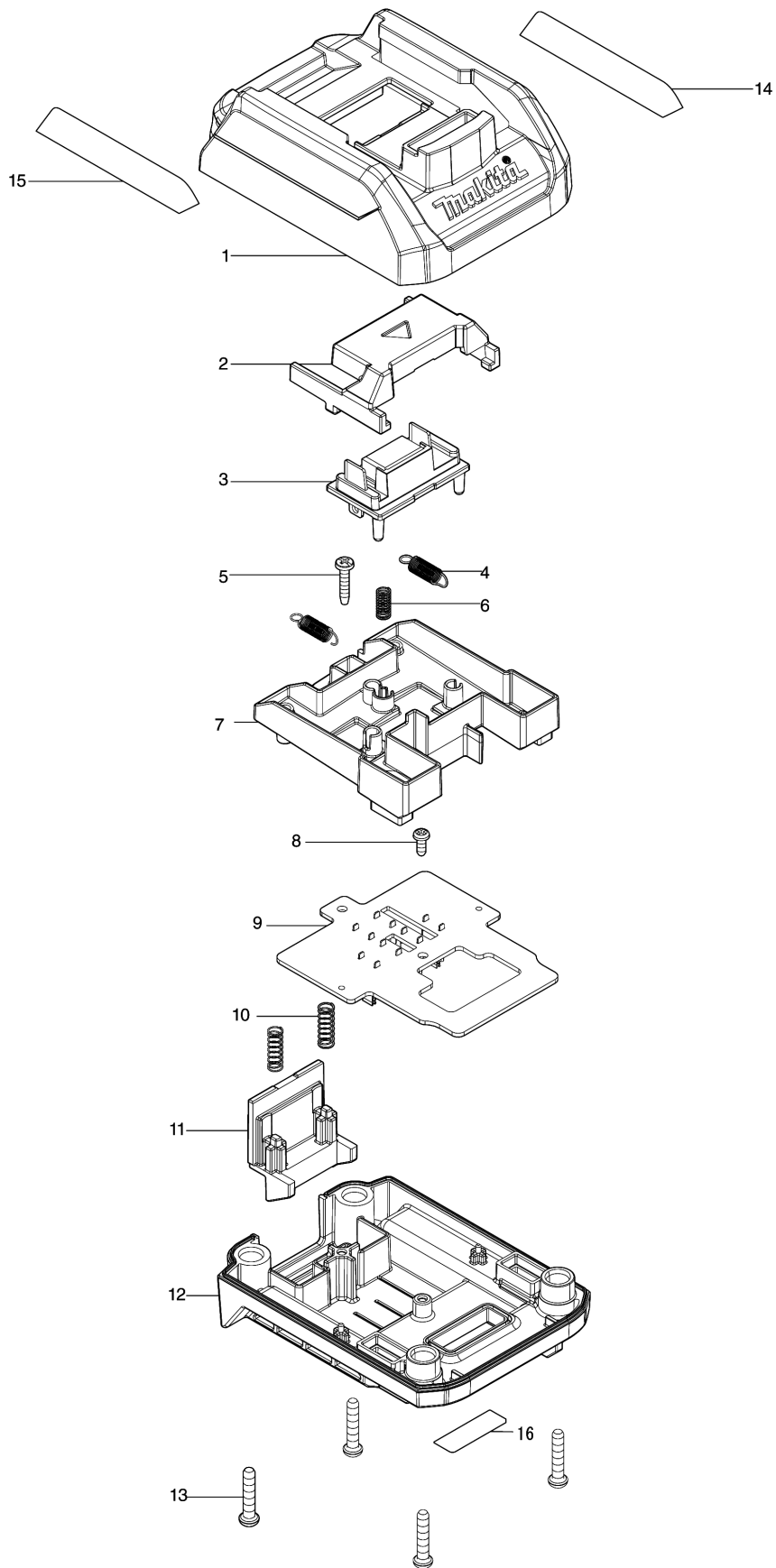

Model No.ADP10 INTERCHANGEABLE ADAPTER

Item	Parts No.	Description	I/C	Qty	New/Old	Opt. 1	Opt. 2	Note
001	459737-0	ADAPTER CASE		1				
002	459740-1	TERMINAL COVER		1				
003	632N92-1	TERMINAL UNIT		1				
004	232604-2	TENSION SPRING 5		2				
005	265B03-5	TAPPING SCREW PT 3X16		1				
006	232603-4	COMPRESSION SPRING 4		1				
007	459739-6	TERMINAL BASE		1				
008	265B02-7	TAPPING SCREW 3X8		1				
009	620B80-8	ADAPTER CIRCUIT		1				
010	232603-4	COMPRESSION SPRING 4		2				
011	459741-9	HOOK		1				
012	459738-8	ADAPTER CASE COVER		1				
013	265B01-9	TAPPING SCREW PT 4X20		4				
014	8004U3-3	INDICATION LABEL L		1				
015	8004U4-1	INDICATION LABEL R		1				
016	857F49-5	ADP10 NAME PLATE		1				

Please order the parts with part number.

Print Date 12/3/2020